

# AOCS

Automatic Orientating  
Clamping System



# DESCRIPTION

**The AOCS (Automatic Orientating Clamping System) by Bilz makes the fully automatic change of tools during machining with industrial robots possible.**

The quick change system can be engaged and disengaged whatever the rotational position of the spindle. After arriving at the magazine, an axial movement in the direction of the quick change adaptor is all that is required. An axial movement in the opposite direction disengages the quick change adaptor.

The reliable and robust interface to the automatic tool change means that saving of valuable machine time is possible. Just like a relay race, the changeover is the critical factor for success.

Do not lose time and continue the process seamlessly.





Accurate,  
robust, easy –  
the quick  
change adaptor  
for a reliable  
changeover

## FEATURES

- **quick and automatic tool change, independent of the rotational position of the spindle**
- **for deburring, brushing, polishing, grinding, etc.**
- **suitable for tool and component guided machining**
- **axial length compensation on tension and optionally also on compression**
- **interface to the machine according to customers' specifications**
- **standard quick change adaptor with collet or specifically adapted to your application**

# ADVANTAGES

- **increased productivity due to reduced tool change times**
- **one clamping chuck for different quick change adaptors, specific to the application**
- **can be used in combination with less complex spindles**
- **easy system integration**



Anyone who has focussed on cycle times during processing will probably have used a component guided process with all its disadvantages.

The quick change system AOCS means that tool guided processing becomes more attractive. The advantages here are the smaller loads which have to be moved as well as the smaller work space needed.

But there are also advantages of the AOCS in component guided processing. The changing of worn tools is quickly done and easily automated.

Whichever machining process you choose, the AOCS from Bilz optimizes your process.





Switch to  
fully-automatic  
machining  
with Bilz.



**bilz**

## Quick change system for industrial robots

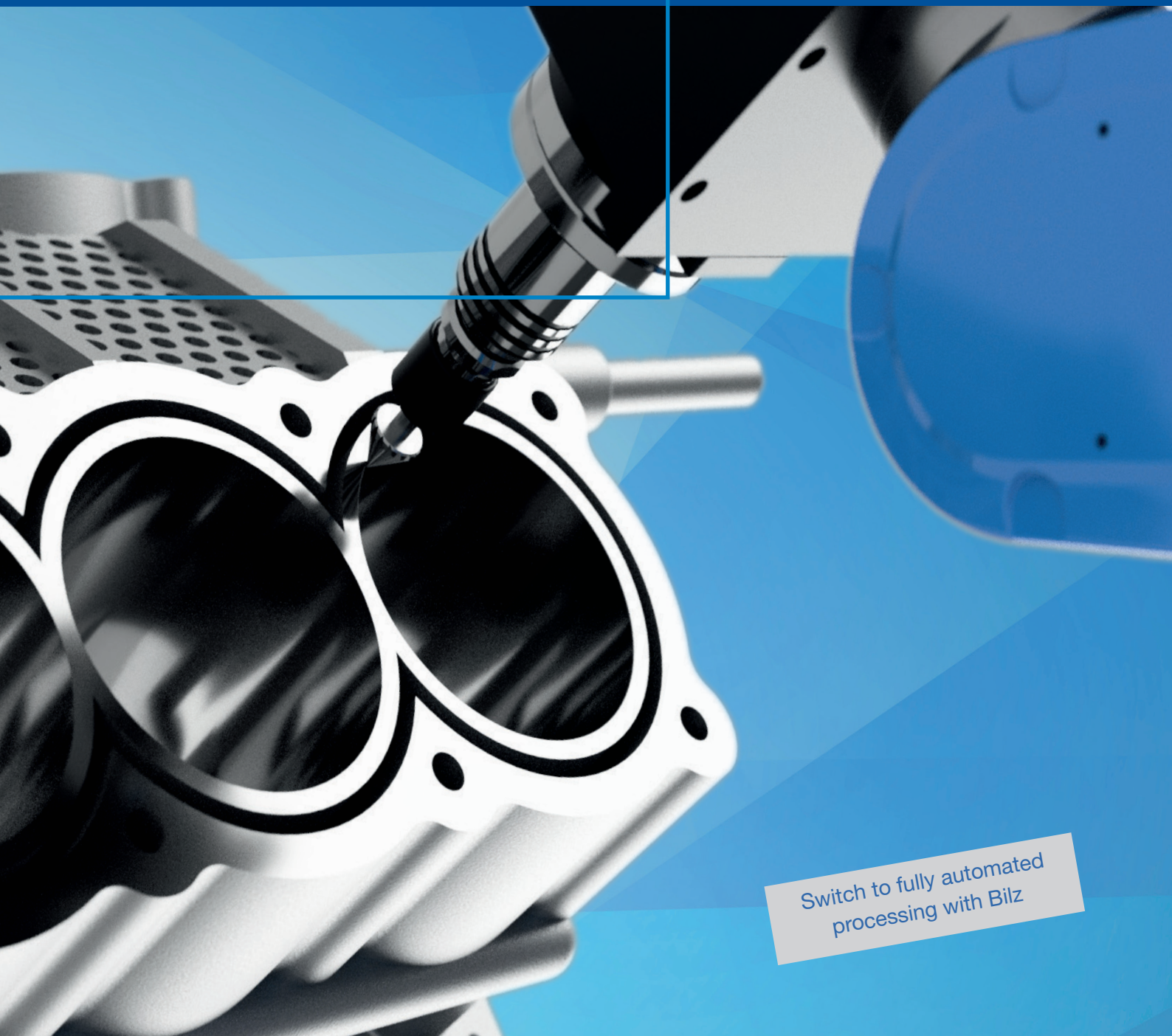

Switch to fully automated  
processing with Bilz

# Precise, robust, simple to apply – The quick change connection for reliable tool exchange

The AOCS (Automatic Orientation Clamping System) from BILZ enables fully automatic tool changing when machining with robots.

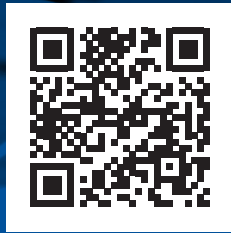

AOCS in combination with ETO engraving chuck

## How it works

The very high-quality AOCS system enables a position-independent tool change via a star-shaped coupling mount. The machine spindle, for example, does not have to be positioned into a special fixture for this.

The tool-change is completed with the help of a special change station, this facilitates the pushing back of the coupling sleeve. The spindle can be installed stationary or mounted on the robot.

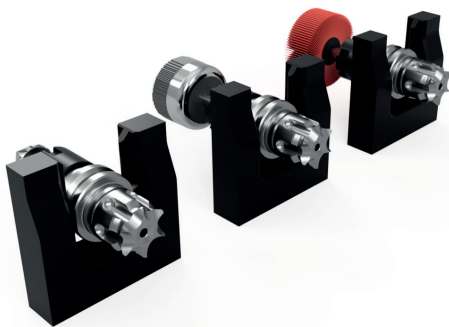
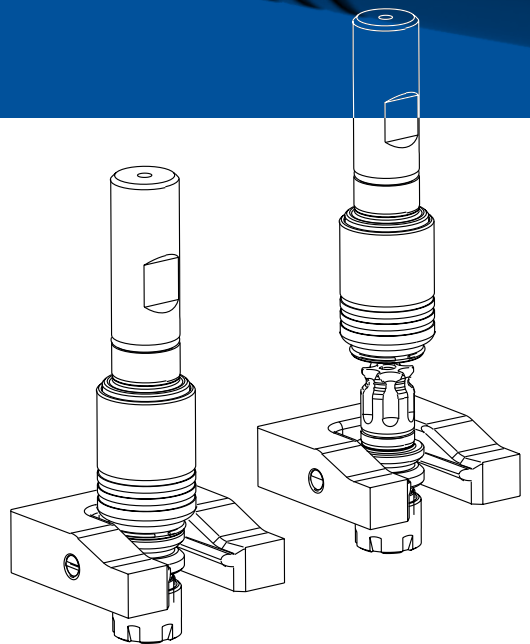

### Tool-guided machining:

The use of the AOCS quick-change system makes tool-guided machining more beneficial: the advantages are the significantly smaller moving loads and the reduction of the working space

### Workpiece guided machining:

Used when the processing focus is on minimising cycle times. AOCS supports you here with the quick changing of worn tools with simple automation processes.

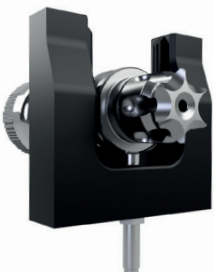

## NEW

OUR AOCS TOOL STORAGE SYSTEM CAN BE EQUIPPED WITH SENSOR TECHNOLOGY.



## Features

- Fast automated tool change
- For tool and workpiece-guided machining
- Independent of the rotational position of the drive spindle
- Axial length compensation in using a compensating compression range, optionally also available with tension compensation
- Machine-side interface according to customer requirements
- Interchangeable with collet chuck as standard or individually adapted

## Benefits

- Simple system integration
- Increased productivity due to reduced tool change times
- One chuck for different application-specific interchangeable tooling
- Use with drive spindles with low complexity



The interchangeable connections are available in three sizes. The chucking tools suited to ER11 to ER25 covers the complete clamping range of cutters and tooling from 1mm to 16mm.

### The ability to change tooling successfully is the key factor for process optimisation.

The **AOCS** quick change system as a reliable and robust interface for automated tool changes, reduces machine down-time thus saving valuable machine time. The quick-change system can be used independently of the rotational positioning of the drive spindle and can load and unload the desired tooling for brushing, deburring polishing and even grinding applications.

After reaching the magazine location, only an axial movement is required for tool changing. Movement in the direction of the interchangeable connection is necessary. Axial movement in the opposite direction disengages the connection. The **AOCS** quick change system can be used in many ways, it supports your production with deburring, brushing, polishing, grinding, and much more.

### Chuck standards

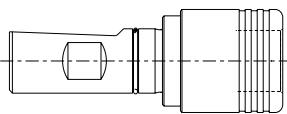
Designation	Max. load	Weight	Ident No.	Location standard
AOC0-35-N-W16	10Nm	0,149	5163138	
AOC1-40-N-W20	30Nm	0,290	5162467	
AOC2-60-N-W25	90Nm	0,827	5162477	

### Quick-change inserts

Designation	Max. load	Weight	Ident No.	Quick-change insert
AOA0-ER11M-25-N	7..14Nm (Ø3...Ø6 @ ER11M)	0,038	5161418	
AOA0-ER16M-40-N	10..25Nm (Ø4...Ø10 @ ER16M)	0,067	5161419	
AOA1-ER16M-34-N	10..25Nm (Ø4...Ø10 @ ER16M)	0,090	5162473	
AOA2-ER25M-42-N	30..60Nm (Ø8...Ø16 @ ER25M)	0,342	5162475	

### Filing system

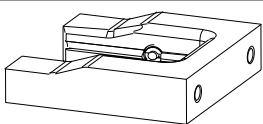
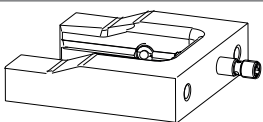
Designation	Weight	Ident No.	Filing system
AOSZ0	0,149	5162292	
AOSZ1	0,290	5169202	
AOSZ2	0,827	5169203	
AOSZ0-S (with inductive sensor)	0,149	5183130	
AOSZ1-S (with inductive sensor)	0,290	5183136	
AOSZ2-S (with inductive sensor)	0,827	5183137	



# Quick change system for industrial robots



## Our AOCs change system from Bilz offers you a high degree of flexibility in your processing line

With the integrated system, tools can be changed fully automatically and without stopping the machining process. This is a great advantage, especially for applications with relatively short change intervals. If a component has to be machined with different tools to accommodate various materials, e.g. cast aluminium, magnesium or plastic housings, a single spindle is usually sufficient.

### Overview of the Machine-side connections - customer solutions

Designation	Weight	Description	Location
AOC0-55-N-S	0,141	Screwed into spindle	
AOC0-55-N-S	0,096	Screwed on to spindle	
AOC00-34-N-S	0,052	Screwed into spindle	
AOC0-116-N-S	0,300	Chuck with 10 mm compression	
AOC2-61-K1-S	1,188	Clamped on Robot spindle	
AOC0-40-N-S	0,104	Chuck with hexagon drive	
AOC2-90-N-B16	0,808	With "B" Taper connection	
AOC0-45-N-S	0,083	Screwed on to spindle	
AOCP1-63-N-W20	0,427	Radial float	
AOC1-80-K3-S	0,603	With external through coolant supply	
AOC0-53-N-S	0,153	Clamping on motor shaft	
AOC2-78-N-S	0,872	Axial spindle clamping for shaft with parallel key	

Special solutions possible on request



# 日 易 暉 机 械

台北市敦化南路二段40號2樓 郵遞區號: 106  
2/F, No. 40, Sec. 2, Tun Hwa S. Road,  
Taipei, Taiwan Zip: 106  
Tel: 886-2-2705-8448  
Fax: 886-2-2700-8430

上海市天鑰橋路325號嘉匯國際廣場A幢2101-2102室 郵編: 200030  
Room 2101-2102, Gateway International Plaza, Building A, No.325, Tian  
Yao Qiao Road, Shanghai, China Zip: 200030  
Tel: 86-21-3363-2088 & 3363-2099  
Fax: 86-21-3363-3303

上海辦事處	電話: 86-21-3363-2088	傳真: 86-21-3363-3303
天津辦事處	電話: 86-22-5817-3069	傳真: 86-22-5817-3069
成都辦事處	電話: 86-28-8526-6681	傳真: 86-28-8526-6684
重慶辦事處	電話: 86-23-6757-3205	傳真: 86-23-6757-3207
長春辦事處	電話: 86-431-8461-7085	傳真: 86-431-8461-7087
外高橋保稅庫	電話: 86-21-5868-3075	傳真: 86-21-5868-3076

台北辦事處	電話: 886-2-2705-8448	傳真: 886-2-2700-8430
台中辦事處	電話: 886-4-2463-8159	傳真: 886-4-2463-8160