



# ALLIED MACHINE & ENGINEERING

Holemaking Solutions for Today's Manufacturing



Drilling



Boring



Reaming



Threading



Specials



## Roller Burnishing

► *BURNISHING*

Finishing Solutions by S.C.A.M.I.®

**S.C.A.M.I.®**

## North America

### Allied Machine

120 Deeds Drive  
Dover, OH 44622  
United States

### Allied Machine

485 West 3rd Street  
Dover, OH 44622  
United States

### ThreadMills USA™

4185 Crosstowne Ct #B  
Evans, GA 30809  
United States

### Superion™

1285 S Patton St.  
Xenia, OH 45385  
United States

## Europe

### Allied Machine Europe

93 Vantage Point  
Pensnett Estate  
Kingswinford  
West Midlands  
DY6 7FR, United Kingdom

### Wohlhaupter® GmbH

Maybachstrasse 4  
Postfach 1264  
72636 Frickenhausen  
Germany

## Asia

### Wohlhaupter® India

B-23, 2nd Floor  
B Block Community Centre  
Janakpuri, New Delhi - 110058  
India



Allied Machine & Engineering is a worldwide leader in holmaking and finishing solutions. We are committed to providing practical and dependable solutions to our customers through innovative designs and superior customer and technical support.

We continue to expand our product offering in order to provide new and different solutions. With Field Sales Engineers located around the world, we position ourselves to provide technical support on site, right at your spindle.



**ALLIED MACHINE**  
**& ENGINEERING**

[www.alliedmachine.com](http://www.alliedmachine.com)

# S.C.A.M.I.® Roller Burnishing

## The Foundation

Since 1941, Allied Machine & Engineering has provided dependable and practical holemaking solutions to the world. What was once a small job shop in Ohio is now a worldwide leader in cutting tool technology. With three manufacturing facilities in Ohio, one in Georgia, another in Germany, and headquarters in both the United States and Europe, Allied Machine is positioned to bring innovative solutions and technical expertise directly to the customers' hands.



## The Beginning

Harold E. Stokey founded Allied Machine & Engineering to aid the war effort, manufacturing taper bearing lock nuts for the production of M1 tanks. Years later, after a sales meeting gone wrong, Stokey possessed a warehouse stocked with spade drill inserts. He set forth into the industry that would become Allied Machine's thriving identity: holemaking.



## The T-A®

When Harold's son, William H. Stokey, became the president and CEO, he developed the Throw Away, or T-A, spade drill insert system. The T-A revolutionized the holemaking industry, launching Allied Machine ahead of the competition. Since then, numerous innovations and advancements have been created from the T-A's inspiration.



## The Innovation

Since the development of the T-A, Allied Machine has expanded its product offering to support a vast range of customer applications, including large diameter and deep hole drilling, boring, reaming, burnishing, porting, and threading.

## The People

Allied Machine understands that high quality products are only one facet of success. Our customer support is crucial to what we do, and that's why we make sure the best engineers and customer service associates are in place to assist our customers around the world.

## The Future

With over 75 years of experience, Allied Machine has encountered the challenges of growth and success. By investing in cutting edge technology and the brightest and sharpest minds, our knowledge and capabilities continue to expand and grow every day.



**Steve Stokey**  
Executive Vice President

**William H. Stokey**  
President and CEO

**Mike Stokey**  
Executive Vice President



## Replaceable Insert Drills

- Reduce costs by decreasing set-up time and utilizing a single holder for the lives of multiple inserts
- Provide flexibility to quickly switch between inserts with different geometries
- Products:
  - GEN3SYS® XT | GEN3SYS® XT Pro
  - Original T-A® | GEN2 T-A®
  - High Performance | Universal



## Indexable Insert Drills

- Protect your investment and reduce your inventory with replaceable cartridges that allow the same holder to be used repeatedly
- Indexable inserts increase productivity and tool life while reducing costs
- Products:
  - 4TEX® Drill
  - Revolution Drill®
  - Opening Drill®



## Replaceable / Indexable Insert Drills

- Allow for higher spindle speeds and take advantage of the power curve on modern CNC machines
- Achieve maximum penetration rates in deep hole drilling applications
- Holders cover a range of sizes with the replaceable heads determining the cutting diameter
- Products:
  - APX™ Drill



## Solid Carbide Drills

- Offer greater strength and stability when drilling tougher materials
- Available in diameters from 3mm - 20mm
- Can be made-to-order specifically for your application (Superion™ quoted specials)
  - ASC 320®
  - Superion™



## Structural Steel Solutions



- Deliver outstanding performance and durability in structural steel applications
- Designed to produce optimal results in difficult-to-machine materials
- Available in multiple lengths and diameters
- T-A® style drills have different insert geometry options to improve performance depending on material
- Products:
  - **Original T-A®** | **GEN2 T-A®**
  - **GEN3SYS® XT Pro**

## BTA (STS) Machining Solutions

- The internal ejection system flushes chips and debris from the hole with no interference to the cutting process
- Utilizes the advantages of the T-A® drill insert
- Designed to significantly increase penetration rates over brazed heads and traditional gun drills
- Products:
  - **BT-A Drill**



## Hydraulic Port Contour Cutters



- Save significant time and money by performing four processes in one step
- Replaceable insert design reduces costs, inventory, and set-up times
- Available in 4 industry specifications:
  - Imperial: SAE J-1926
  - Metric: ISO 6149-1:2006
  - Military: SAE AS5202
  - John Deere: JDS-G173.1
- Products:
  - **AccuPort 432®**



## Enhanced Special Drilling Capabilities

- Allied Machine Engineers are available to meet with you to evaluate your application and recommend the best solution for you
- Special drilling solutions can incorporate advanced features such as adjustable diameter locations, multiple steps, additional coolant designs, special lengths and diameters, and more
- Special drills can drastically reduce your cost-per-hole and increase your overall productivity by eliminating multiple processes and increasing tool life



## WOHLHAUPTER® High Precision Boring Systems

- Designs available for high volume applications that increase rigidity to improve performance
- Versatile boring heads that are flexible with changing applications while maintaining excellent performance
- Provides high precision with absolute repeatability to ensure every part is held to tolerance
- Offers an industry leading modular shank connection that maintains rigidity and reduces inventory on your boring system
- Available with both digital and analog settings
- Products:
  - Wohlhaupter® Boring Tools



## CRITERION® Modular Boring Systems

- The modular capabilities are ideal for use across multiple different projects
- Offers versatile boring heads suitable for all job shops and tooling rooms
- Provides an economical solution for low volume and/or short-term production applications
- Offers both rough and finish boring solutions
- Products:
  - Criterion® Boring Tools

## S.C.A.M.I.®

### Expandable Reaming Solutions

- Expandable cutting diameters accommodate for wear, which extends tool life
- Replaceable cutting heads and rings reduce waste and improve production time versus solid high speed steel and carbide reamers
- Hold tight tolerances to ensure processes are performed to accurate specifications
- Reduce tooling costs because many items are available for recondition
- Products:
  - ALVAN® Reamers



## S.C.A.M.I.®

### Roller Burnishing Solutions

- Produce excellent surface finishes
- Provide accurate size control
- Increase surface hardness
- Solutions for both through hole and blind hole applications
- Products:
  - S.C.A.M.I.® Roller Burnishing Tools





## Solid Carbide Thread Mills

- Available with coolant through options
- Cover a wide range of thread forms
- Provide optimal solutions for both high production projects and short-run applications
- Products
  - AccuThread™ 856
  - AccuThread™ T3
  - ThreadMills USA™



## Replaceable Insert Thread Mills

- 3 insert lengths are available that cover a wide range of thread forms
- Holders can utilize inserts with different pitches and thread forms
- Repeatability is achieved by both the bolt-in style and the pin style locking systems
- Increase tool life by 25 - 50% with Allied Machine's AM210® coating
- Products
  - AccuThread™ 856: Bolt-in Style
  - AccuThread™ 856: Pin Style



## SPECIAL CAPABILITIES

When it comes to designing and developing special solutions for customers, Allied Machine is the top choice. If your application requires special tooling, give us a call. Our engineered specials are developed by the brightest engineers in the industry. Most of our standard tooling can be altered as specials, or we can create entirely new concepts for particularly unique applications.

One special tooling solution is Insta-Quote®, the online system that allows you to design your own special tooling 24/7. Receive a quote and drawings within minutes just by following the steps.

And with the addition of Superior™ technology and capabilities, we can customize made-to-order solid carbide tools to achieve optimal results for your applications.

Whatever your application, Allied Machine has the answer.



Insta-Quote® 

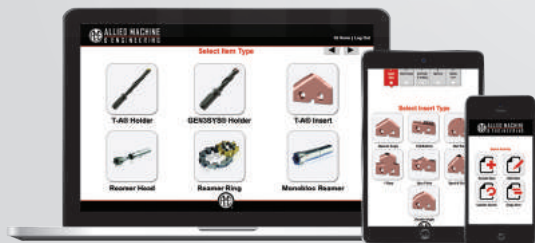

 SUPERION™



# ToolMD™

Increase the production and success of your applications today.

- Offers direct access to 2D drawings and 3D models
- Assemble and view tool images in your browser
- Download drawings for use in most machining software programs
- Browse products, search item numbers, and save assemblies for future use



[toolmd.com](http://toolmd.com)

## WOHLHAUPTER® Tool-Architect

Find the right Wohlhaupter® solution for your application.

- Configure your complete tool assembly
- Compile an order list to be quoted
- Search and quickly find components using various criteria
- Adjust your language and measurement preferences



[tool-architect.com](http://tool-architect.com)

## Insta-Quote®

Design your custom tooling and receive a drawing and quote...all within minutes.

- Design and quote your own tooling
- Guides you through steps to generate the solution you need
- Features the following products
  - T-A® Inserts
  - T-A® Holders
  - GEN3SYS® XT Holders
  - ALVAN® Reamers

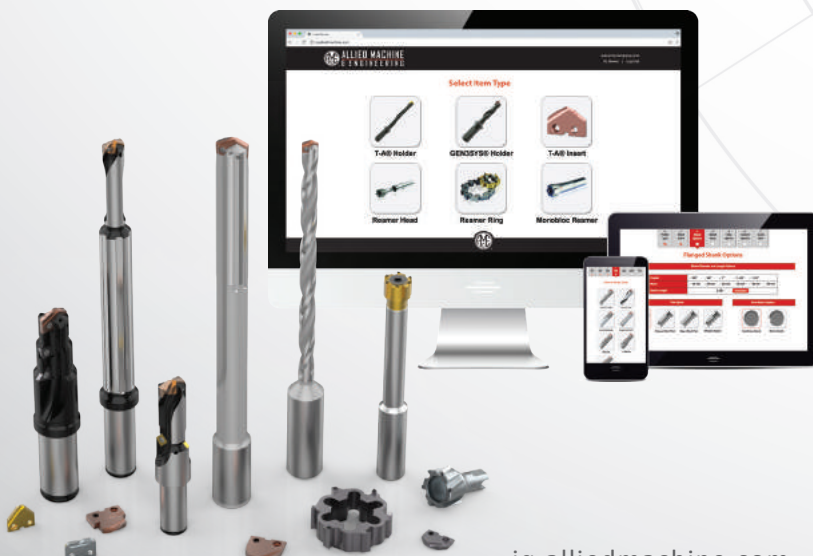

[iq.alliedmachine.com](http://iq.alliedmachine.com)



# Insta-Code®

Eliminate the wait. Get your program now.

- Choose the best thread mill for your application
- Create program code for your machine
- Available as a PC download app (that can be used offline)
- Website app available 24/7



Insta-Code also has a  
**Cycle Time Calculator**

[alliedmachine.com/InstaCode](http://alliedmachine.com/InstaCode)

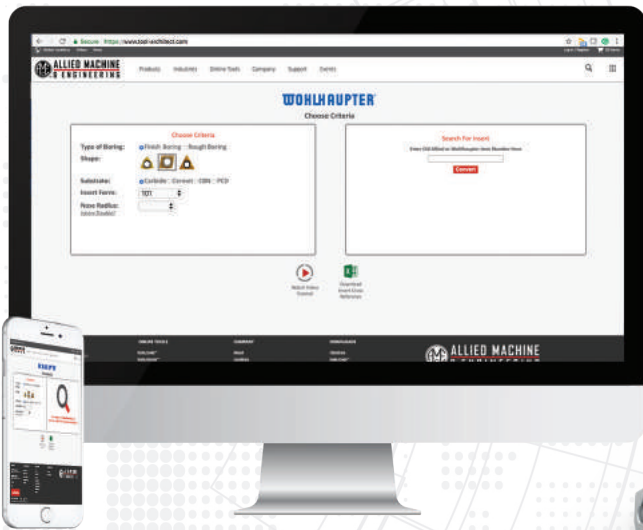

## WOHLHAUPTER® Boring Insert Selector

Find the best insert for your application.

- Generate the correct boring insert for your job in just six easy steps
- Choose type, shape, substrate, insert form, nose radius, and material
- Easily order by adding the item to your cart

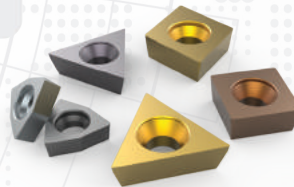

[www.alliedmachine.com/bis](http://www.alliedmachine.com/bis)

## Product Selector

Use the product selector to find the right tool for your application.

- Guides you through steps to generate the right tool for your application
- Learn about your recommended tool and how to maximize its performance



[www.alliedmachine.com/productselector](http://www.alliedmachine.com/productselector)

## Machinist Tool App

Quickly convert cutting tool parameters for the machine inputs you need.

- Input data to calculate the RPM and speed and feed rates
- Also features the Boring Insert Selector
- Access product literature right at your fingertips

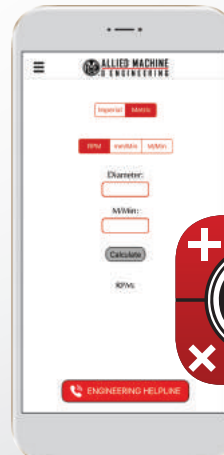

# Roller Burnishing Systems

Through Hole Style | Blind Hole Style



## Get the Finish You Need

Allied Machine is proud to offer roller burnishing tools from S.C.A.M.I.®. These hole finishing tools provide extremely high-quality surface finish on both through hole and blind hole applications. With roller burnishing, you can eliminate the need for slower and more costly finishing processes and secondary operations such as grinding, honing, and lapping.

Not only will the roller burnishing tools create a smooth surface finish, but they will also harden the material and increase the wear resistance of the part. The benefits of this single operation result in the hole quality you should expect from Allied Machine.

Creates fine surface finishes	Increases wear and corrosion resistance	Eliminates other processes and saves you money
-------------------------------	-----------------------------------------	------------------------------------------------

## Applicable Industries

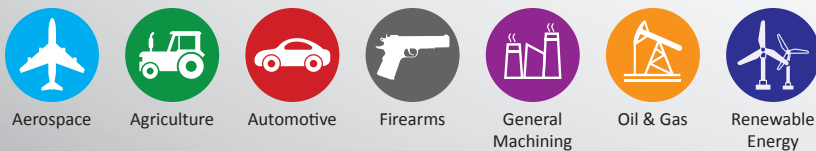

Your safety and the safety of others is very important. This catalog contains important safety messages. Always read and follow all safety precautions.



This triangle is a safety hazard symbol. It alerts you to potential safety hazards that can cause tool failure and serious injury.

When you see this symbol in the catalog, look for a related safety message that may be near this triangle or referred to in the nearby text.

There are safety signal words also used in the catalog. Safety messages follow these words.

### **WARNING**

**WARNING** (shown above) means that failure to follow the precautions in this message could result in tool failure and serious injury.

**NOTICE** means that failure to follow the precautions in this message could result in damage to the tool or machine but not result in personal injury.

**NOTE** and **IMPORTANT** are also used. These are important that you read and follow but are not safety-related.

Visit [www.alliedmachine.com](http://www.alliedmachine.com) for the most up-to-date information and procedures.

# Roller Burnishing Systems Contents

## Reference Icons

The following icons will appear throughout the catalog to help you navigate between products.



### Technical Information

Detailed instructions and information regarding the corresponding part(s)

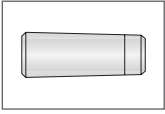

### Through Hole Rolls

Refers to the rolls available for through hole burnishing tools

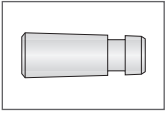

### Blind Hole Rolls

Refers to the rolls available for blind hole burnishing tools

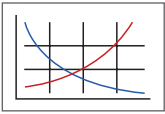

### Recommended Cutting Data

Speed and feed recommendations for optimum and safe burnishing

Series	Diameter Range	
	Imperial (inch)	Metric (mm)
H	0.1555 - 0.5028	3.95 - 12.77
I	0.4976 - 0.6634	12.64 - 16.85
K	0.6535 - 0.9740	16.60 - 24.74
L	0.9661 - 1.2268	24.54 - 31.16
F	0.9661 - 1.2268	24.54 - 31.16
M	1.2146 - 1.4118	30.85 - 35.86
N	1.4020 - 1.8492	35.61 - 46.97
O	1.8390 - 2.2240	46.71 - 56.49
P	2.2138 - 2.7240	56.23 - 69.19
Q	2.7138 - 3.3492	68.93 - 85.07
R	3.3390 - 4.0992	84.81 - 104.12
S	4.0890 - 5.0370	103.86 - 127.94
T	5.0354 - 5.9016	127.90 - 149.90
U	5.9016 - 6.5315	149.90 - 165.90



Allied Machine & Engineering offers Roller Burnishing tools through an exclusive supply agreement with S.C.A.M.I. s.n.c.

S.C.A.M.I. is an Italian manufacturer that has been producing high quality cutting tools for over 40 years.

Visit [www.alliedmachine.com](http://www.alliedmachine.com) for additional information about all Allied Machine products, or contact our Application Engineering department for technical assistance.

## Introduction Information

Roller Burnishing Overview . . . . .	2 - 3
Product Offering . . . . .	4
Product Selection Guide . . . . .	5
Product Nomenclature . . . . .	6

## Burnishing Series

H Series . . . . .	7 - 11
I Series . . . . .	12 - 13
K Series . . . . .	14 - 15
L Series . . . . .	16 - 17
F Series . . . . .	18 - 19
M Series . . . . .	20 - 21
N Series . . . . .	22 - 23
O Series . . . . .	24 - 25
P Series . . . . .	26 - 27
Q Series . . . . .	28 - 29
R Series . . . . .	30 - 31
S Series . . . . .	32 - 33
T Series . . . . .	34 - 35
U Series . . . . .	36 - 37

Rolls . . . . .	38 - 39
-----------------	---------

## Technical Information

Diameter Adjustment . . . . .	40
How the Burnisher Works . . . . .	41

## Recommended Cutting Data

Imperial (inch) . . . . .	42 - 43
Metric (mm) . . . . .	44 - 45

## Roller Burnishing Overview

### The Principle of Roller Burnishing

Roller burnishing is a cold-working process that produces a fine surface finish. The planetary rotation of the hardened rolls creates pressure over a metal surface. Unlike cold rolling, which produces large sectional changes, roller burnishing involves cold-working on the surface of the workpiece to improve the surface structure.

All machined surfaces consist of a series of peaks and valleys, all having irregular height and spacing. The plastic deformation created by roller burnishing is a displacement of the material in the peaks. When under pressure, the material in the peaks flows into the valleys. During the process, tool marks and irregularities are rolled out, resulting in a mirror-like finish with a tough, work-hardened surface that is also wear and corrosion resistant.

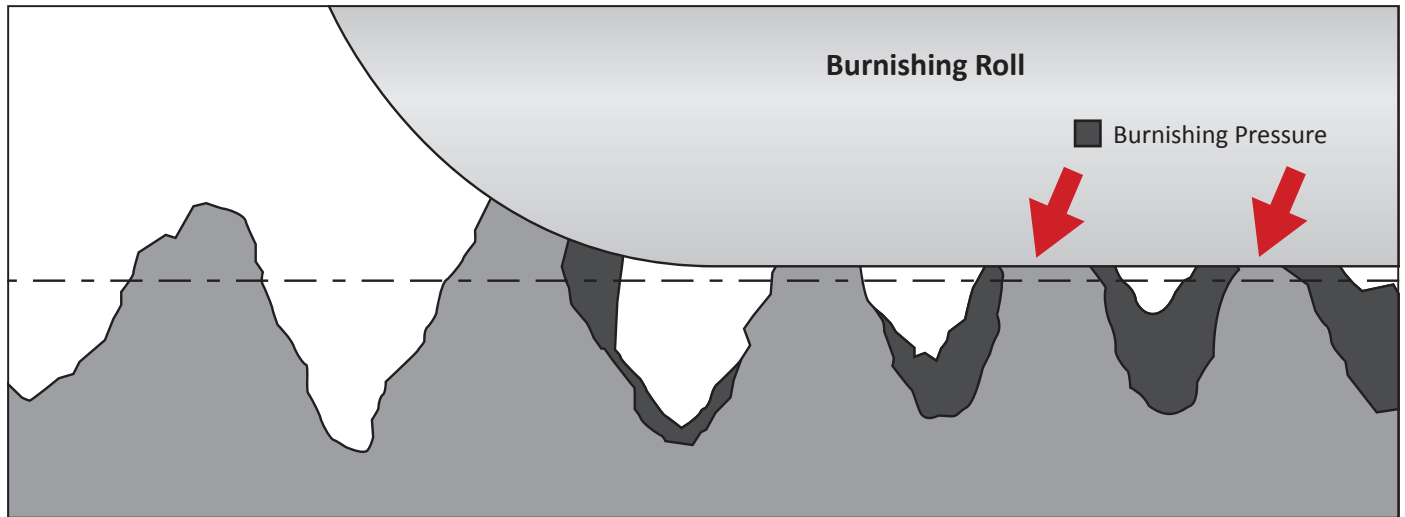

#### Advantages of Roller Burnishing: Metallurgical Properties

- Grain structure is condensed and refined.
- The compacted surface is **smoother, harder, and more wear resistant** than ground or honed surfaces.
- The process reduces surface porosity and also removes scratches that could hold reactive substances or contaminants. **This increases the corrosion resistance.**
- Depending on the material, the surface hardness can be **increased by as much as 10 points Rockwell C**. This may eliminate the need for heat treatment.
- The plastic deformation induces residual compressive stresses in the surface of the part. This increases the strength properties and fatigue life of the part because any forces on the part must overcome these residual stresses, as well as the tensile strength of the materials, before fatigue conditions occur.

#### Advantages of Roller Burnishing: Surface Finish

- Creates a high finish to any machinable metal.
- Surfaces that are bored, reamed, or turned to 125 micro inches or more can be finished to 4 micro inch CLA or less in one pass (at feed rates of 125 to 300 mm/min).
- Roller burnishing replaces grinding, honing, lapping, and other expensive secondary operations.
- Tool marks are rolled out.

### The Process

- The first contact with the machined surface occurs in Section A.
- Plastic deformation occurs in Section B as the yield point of the surface is exceeded.
- Section D is the pressurized depth.
- Once the material endures the maximum compressive strain (Section C), it starts relieving elastically (Section E) through the finishing zone.
- This leaves a smooth surface and a compressive residual stress of significant peak value.
- The stresses formed on the material during the compression decrease toward the center. These stresses reach approximately 1mm below the surface. This increases the surface hardness.

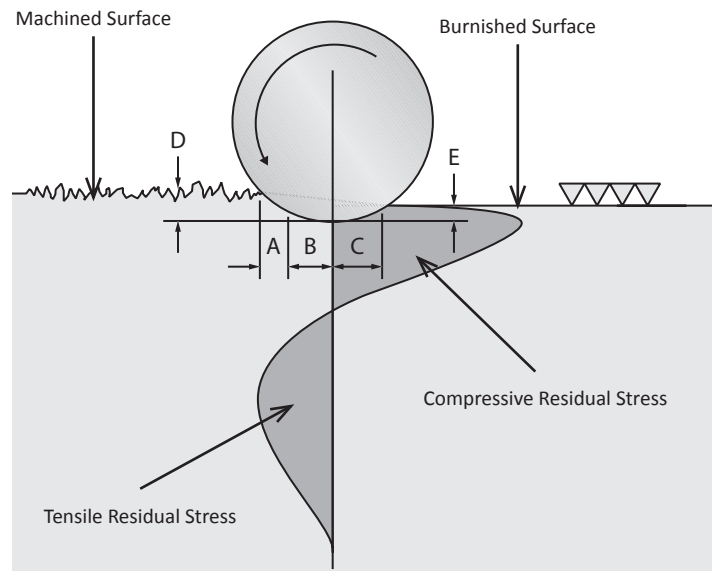

## Roller Burnishing Overview

### When to Roller Burnish

#### Conditions for Roller Burnishing

Roller burnishing is a cold working process used to achieve fine hole finishes. In order to achieve the most optimal results, adhere to the benchmarks below:

- **Finishing:** The ductility and hardness of the workpiece material along with the surface preparation dictates the quality of the burnished finish.
- **Workability:** Any ductile and malleable material up to RC40 can be roller burnished.
- **Worked Surface Properties:** Workpieces with an interrupted surface within 10% of the circumference can be successfully burnished with a standard tool (see Figures 1 and 2).

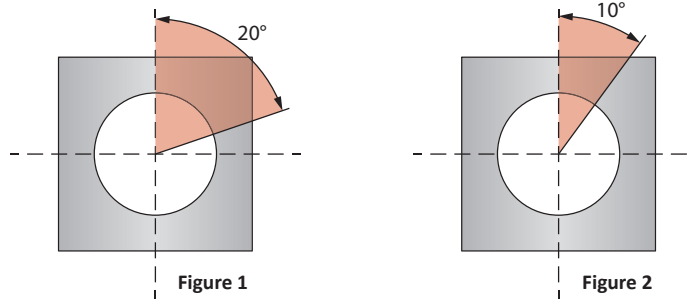

- **Tolerance of the Burnished Piece:** The tolerance range achieved from the burnishing will be equal to that achieved from the pre-machining since no material will be removed.

The ideal surface for burnishing consists of a succession of peaks. These peaks correspond on regular feed of the preparation tool (see Figure 3). We suggest the ALVAN® expandable reamer for pre-burnishing because it creates a uniform roughness and a tolerance range of H6 - H7.

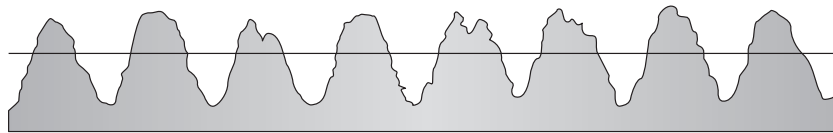

Figure 3

Pre-machining tapers and surface irregularities caused by cutting tool failure must be noted because these conditions cannot be corrected by the roller burnishing process (see Figures 4 and 5).

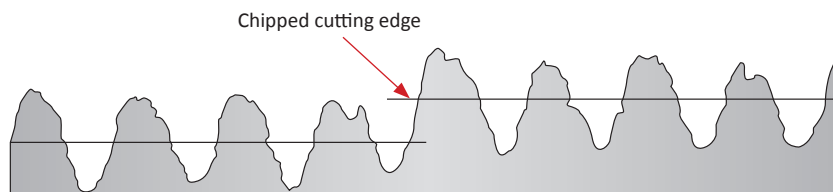

Figure 4

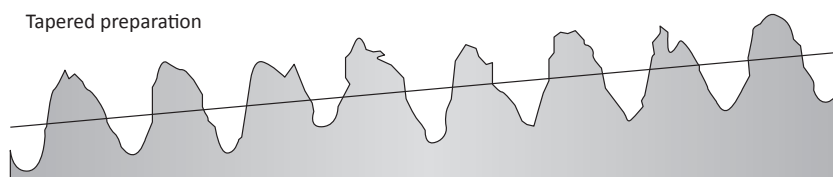

Figure 5

## Product Offering



**Through Hole Style**

0.1555" - 6.5313" (3.95mm - 165.90mm)



**Blind Hole Style**

0.1850" - 6.5313" (4.70mm - 165.90mm)

### *Advantages* of the Roller Burnishing Tool

- ✔ **Provides accurate size control**  
 tolerances within 0.0005" or better (depending on variables such as material)
- ✔ **Produces fine surface finishes**  
 between 1 - 10 microinches Ra
- ✔ **Increases surface hardness**  
 by 5 - 10% or more
- ✔ **Performs a much cleaner operation**  
 than honing or other abrasive finishing methods
- ✔ **Provides versatility**  
 because the operation can be performed on any rotating spindle
- ✔ **Eliminates the need for slower and costly finishing processes and secondary operations**  
 such as grinding, honing, lapping, etc.

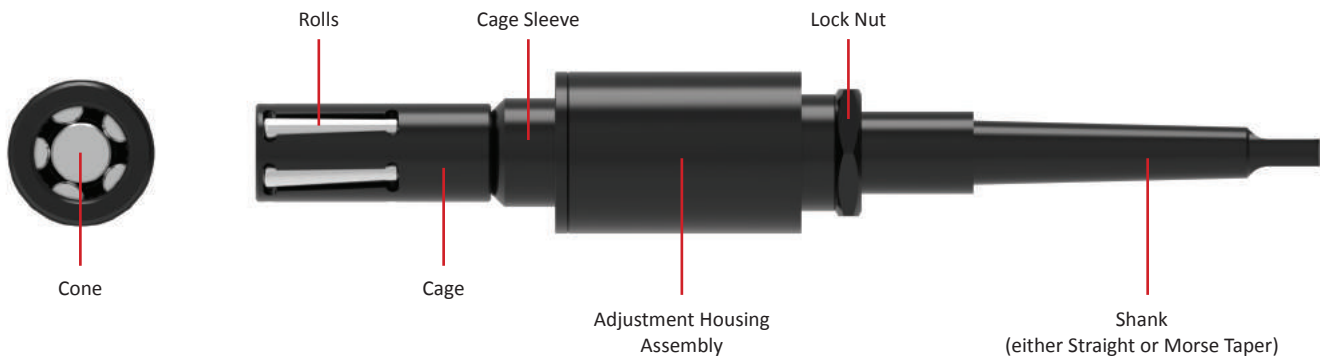

#### The Tool Components

All roller burnishing tools (both through hole and blind hole) are composed of the basic burnisher assembly, including:

- Cage
- Cone
- Rolls
- Shank (either straight or Morse Taper)

**Product Selection Guide**

Series	Diameter Range (inch / mm)						Length				
	0 - 1	1 - 2	2 - 3	3 - 4	4 - 5	5 - 6	6 - 7	Short	Standard	Long	Unlimited
	0 - 25.4	25.4 - 50.8	50.8 - 76.2	76.2 - 101.6	101.6 - 127	127 - 152.4	152.4 - 177.8				
H*	█							✓	✓	✓	
I	█							✓	✓	✓	
K		█						✓	✓	✓	
L		█						✓	✓	✓	
F		█									✓
M		█									✓
N			█								✓
O			█								✓
P			█								✓
Q				█							✓
R				█							✓
S					█						✓
T						█					✓
U							█				✓

\*For H series: through hole tools start at 0.1555" (3.95mm) and blind hole tools start at 0.1850" (4.70mm)

When to **ORDER UP** 

In some cases, there will be a diameter overlap between a series and the series after it. If the diameter you need falls into this overlap, choose the higher of the two series.

**Example:**

You need a 24.64mm diameter tool. This diameter falls into both the K series and the L series.

- K series diameter range = 16.60mm - 24.74mm
- L series diameter range = 24.54mm - 31.16mm

In this scenario, you would choose the L series tool that covers the 24.64 diameter.

## Product Nomenclature

### Roller Burnishing Tools

<b>RDK</b>	<b>H</b>	-	<b>2</b>	<b>1</b>	<b>0</b>	-	<b>004,70</b>
1	2		3	4	5		6

<b>1. Type of Burnisher</b> RDK = Through holes RSK = Blind holes	<b>2. Series</b> H = H series      F = F series      P = P series      T = T series I = I series      M = M series      Q = Q series      U = U series K = K series      N = N series      R = R series L = L series      O = O series      S = S series	<b>3. Shank Type</b> 1 = Straight 2 = Morse Taper
<b>4. Length</b> 0 = Unlimited 1 = Short 2 = Standard 3 = Long	<b>5. Cage Style</b> 0 = Standard	<b>6. Diameter</b> Through Hole Tools = Minimum diameter of burnishing range Blind Hole Tools = Diameter to burnish

### Cone Reduction Factor (Blind Holes)

When burnishing blind holes, the cone must not extend past the end of the rolls. If it does, the cone will collide with the bottom of the hole. Each burnishing tool has an adjustment range of:

- Approximately 0.5mm on diameter for tools below 12.7mm
- Approximately 1.0mm on diameter for tools above 12.7mm

For through hole burnishing tools, the standard cone value "x" is 1. If the standard cone is used for blind hole burnishing, the only way it will not extend past the end of the rolls is to reduce the length of the cone. The required length reduction is dependent on the set diameter versus the minimum capable diameter of the tool. The factor of reduction (x) can be calculated using the formulas below and will be a whole integer number ranging from 2 - 8.

The "x" value could result in a decimal figure. If so, round down for answers below 0.60, and round up for answers 0.61 and above.

<b>Diameter (5.89mm - 12.77mm)</b> $x = 1 + \frac{Z - Y}{0.05}$ Z = diameter of the hole Y = minimum diameter setting of tool <b>Example:</b> Z = 11.05 Y = 10.71mm $x = 1 + \frac{11.05 - 10.71}{0.05} = 7.8$ which is approximated at "x" = 8 <b>Correct Cone:</b> RSTH-038-11025	<b>Diameter (12.64mm - 127.94mm)</b> $x = 1 + \frac{Z - Y}{0.10}$ Z = diameter of the hole Y = minimum diameter setting of tool <b>Example:</b> Z = 17.76 Y = 17.40mm $x = 1 + \frac{17.76 - 17.40}{0.10} = 4.6$ which is approximated at "x" = 4 <b>Correct Cone:</b> RSTK-034-00044	<b>Diameter (127.90mm - 165.90mm)</b> $x = 1 + \frac{Z - Y}{0.10}$ Z = diameter of the hole Y = minimum diameter setting of tool <b>Example:</b> Z = 148.20 Y = 147.90mm $xx = 31 + \frac{148.20 - 147.90}{0.10} = 34$ <b>Correct Cone:</b> RSTT-034-01480
----------------------------------------------------------------------------------------------------------------------------------------------------------------------------------------------------------------------------------------------------------------------------------------------------	------------------------------------------------------------------------------------------------------------------------------------------------------------------------------------------------------------------------------------------------------------------------------------------------------	------------------------------------------------------------------------------------------------------------------------------------------------------------------------------------------------------------------------------------------------------------------------

### Reference Key

Symbol	Attribute
D <sub>1</sub>	Diameter range
L <sub>2</sub>	Burnishing length
L <sub>3</sub>	Reference length

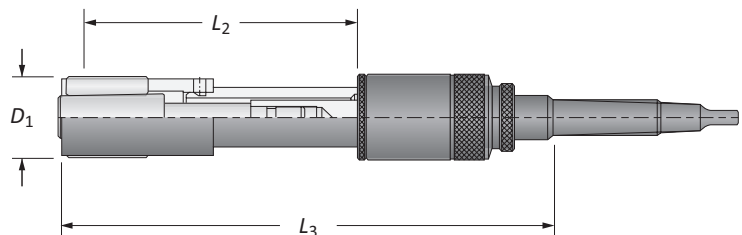





## Roller Burnishing Tools | Through Holes

H Series (mini) | Diameter Range: 0.1555" - 0.1870" (3.95mm - 4.75mm)

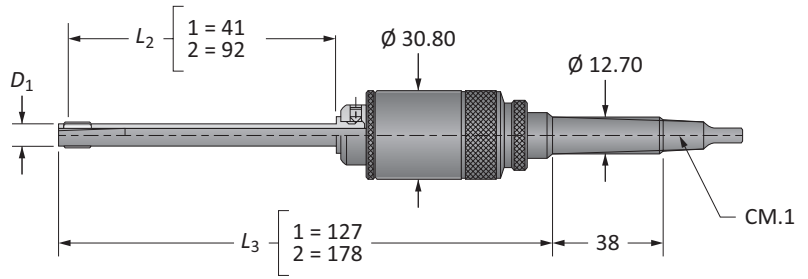

D <sub>1</sub>		L	Part No.		Spare Parts			Qty Rolls
Imperial (in)	Metric (mm)		Assembly with Morse Taper Shank	Assembly with Straight Shank	Cage	Cone	Rolls	
0.1555 - 0.1634	3.95 - 4.15	1	RDKH-212-00395	RDKH-112-00395	RDCH-012-10005	RDTH-031-10012	RDRY-704-00047	3
0.1555 - 0.1634	3.95 - 4.15	2	RDKH-222-00395	RDKH-122-00395	RDCH-012-20005	RDTH-031-20012	RDRY-704-00047	3
0.1638 - 0.1713	4.16 - 4.35	1	RDKH-212-00416	RDKH-112-00416	RDCH-012-10006	RSTH-035-10012	RDRY-704-00047	3
0.1638 - 0.1713	4.16 - 4.35	2	RDKH-222-00416	RDKH-122-00416	RDCH-012-20006	RSTH-035-20012	RDRY-704-00047	3
0.1717 - 0.1791	4.36 - 4.55	1	RDKH-212-00436	RDKH-112-00436	RDCH-012-10007	RDTH-031-10013	RDRY-704-00047	3
0.1717 - 0.1791	4.36 - 4.55	2	RDKH-222-00436	RDKH-122-00436	RDCH-012-20007	RDTH-031-20013	RDRY-704-00047	3
0.1795 - 0.1870	4.56 - 4.75	1	RDKH-212-00456	RDKH-112-00456	RDCH-012-10008	RSTH-035-10013	RDRY-704-00047	3
0.1795 - 0.1870	4.56 - 4.75	2	RDKH-222-00456	RDKH-122-00456	RDCH-012-20008	RSTH-035-20013	RDRY-704-00047	3

**NOTE:** Each roller burnishing tool comes assembled complete with cage, cone, and rolls.

Key on D: 1

D: 42 - 45

D: 40 - 41

D: 38

## Roller Burnishing Tools | Through Holes

H Series | Diameter Range: 0.1850" - 0.5028" (4.70mm - 12.77mm)

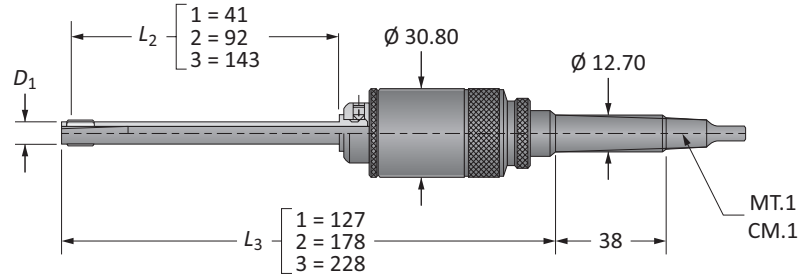

$D_1$		$L$	Part No.		Spare Parts			Qty Rolls
Imperial (in)	Metric (mm)		Assembly with Morse Taper Shank	Assembly with Straight Shank	Cage	Cone	Rolls	
0.1850 - 0.1929	4.70 - 4.90	1	RDKH-210-00470	RDKH-110-00470	RDCH-011-10012	RDTH-031-10012	RDRY-704-00062	3
0.1850 - 0.1929	4.70 - 4.90	2	RDKH-220-00470	RDKH-120-00470	RDCH-011-20012	RDTH-031-20012	RDRY-704-00062	3
0.1850 - 0.1929	4.70 - 4.90	3	RDKH-230-00470	RDKH-130-00470	RDCH-011-30012	RDTH-031-30012	RDRY-704-00062	3
0.1917 - 0.2035	4.87 - 5.17	1	RDKH-210-00487	RDKH-110-00487	RDCH-011-10011	RSTH-033-10012	RDRY-704-00062	3
0.1917 - 0.2035	4.87 - 5.17	2	RDKH-220-00487	RDKH-120-00487	RDCH-011-20011	RSTH-033-20012	RDRY-704-00062	3
0.1917 - 0.2035	4.87 - 5.17	3	RDKH-230-00487	RDKH-130-00487	RDCH-011-30011	RSTH-033-30012	RDRY-704-00062	3
0.1996 - 0.2200	5.07 - 5.59	1	RDKH-210-00507	RDKH-110-00507	RDCH-011-10013	RDTH-031-10013	RDRY-704-00062	5
0.1996 - 0.2200	5.07 - 5.59	2	RDKH-220-00507	RDKH-120-00507	RDCH-011-20013	RDTH-031-20013	RDRY-704-00062	5
0.1996 - 0.2200	5.07 - 5.59	3	RDKH-230-00507	RDKH-130-00507	RDCH-011-30013	RDTH-031-30013	RDRY-704-00062	5
0.2161 - 0.2358	5.49 - 5.99	1	RDKH-210-00549	RDKH-110-00549	RDCH-011-10014	RDTH-031-10013	RDRY-704-00070	5
0.2161 - 0.2358	5.49 - 5.99	2	RDKH-220-00549	RDKH-120-00549	RDCH-011-20014	RDTH-031-20013	RDRY-704-00070	5
0.2161 - 0.2358	5.49 - 5.99	3	RDKH-230-00549	RDKH-130-00549	RDCH-011-30014	RDTH-031-30013	RDRY-704-00070	5
0.2319 - 0.2524	5.89 - 6.41	1	RDKH-210-00589	RDKH-110-00589	RDCH-011-10015	RDTH-031-10015	RDRY-704-00070	5
0.2319 - 0.2524	5.89 - 6.41	2	RDKH-220-00589	RDKH-120-00589	RDCH-011-20015	RDTH-031-20015	RDRY-704-00070	5
0.2319 - 0.2524	5.89 - 6.41	3	RDKH-230-00589	RDKH-130-00589	RDCH-011-30015	RDTH-031-30015	RDRY-704-00070	5
0.2484 - 0.2681	6.31 - 6.81	1	RDKH-210-00631	RDKH-110-00631	RDCH-011-10016	RDTH-031-10015	RDRY-704-00078	5
0.2484 - 0.2681	6.31 - 6.81	2	RDKH-220-00631	RDKH-120-00631	RDCH-011-20016	RDTH-031-20015	RDRY-704-00078	5
0.2484 - 0.2681	6.31 - 6.81	3	RDKH-230-00631	RDKH-130-00631	RDCH-011-30016	RDTH-031-30015	RDRY-704-00078	5
0.2642 - 0.2839	6.71 - 7.21	1	RDKH-210-00671	RDKH-110-00671	RDCH-011-10017	RDTH-031-10017	RDRY-704-00078	5
0.2642 - 0.2839	6.71 - 7.21	2	RDKH-220-00671	RDKH-120-00671	RDCH-011-20017	RDTH-031-20017	RDRY-704-00078	5
0.2642 - 0.2839	6.71 - 7.21	3	RDKH-230-00671	RDKH-130-00671	RDCH-011-30017	RDTH-031-30017	RDRY-704-00078	5
0.2803 - 0.3000	7.12 - 7.62	1	RDKH-210-00712	RDKH-110-00712	RDCH-011-10018	RDTH-031-10017	RDRY-704-00086	5
0.2803 - 0.3000	7.12 - 7.62	2	RDKH-220-00712	RDKH-120-00712	RDCH-011-20018	RDTH-031-20017	RDRY-704-00086	5
0.2803 - 0.3000	7.12 - 7.62	3	RDKH-230-00712	RDKH-130-00712	RDCH-011-30018	RDTH-031-30017	RDRY-704-00086	5
0.2945 - 0.3142	7.48 - 7.98	1	RDKH-210-00748	RDKH-110-00748	RDCH-011-10019	RDTH-031-10019	RDRY-704-00086	5
0.2945 - 0.3142	7.48 - 7.98	2	RDKH-220-00748	RDKH-120-00748	RDCH-011-20019	RDTH-031-20019	RDRY-704-00086	5
0.2945 - 0.3142	7.48 - 7.98	3	RDKH-230-00748	RDKH-130-00748	RDCH-011-30019	RDTH-031-30019	RDRY-704-00086	5
0.3102 - 0.3299	7.88 - 8.38	1	RDKH-210-00788	RDKH-110-00788	RDCH-011-10020	RDTH-031-10019	RDRY-704-00093	5
0.3102 - 0.3299	7.88 - 8.38	2	RDKH-220-00788	RDKH-120-00788	RDCH-011-20020	RDTH-031-20019	RDRY-704-00093	5
0.3102 - 0.3299	7.88 - 8.38	3	RDKH-230-00788	RDKH-130-00788	RDCH-011-30020	RDTH-031-30019	RDRY-704-00093	5
0.3260 - 0.3461	8.28 - 8.79	1	RDKH-210-00828	RDKH-110-00828	RDCH-011-10021	RDTH-031-10021	RDRY-704-00093	5
0.3260 - 0.3461	8.28 - 8.79	2	RDKH-220-00828	RDKH-120-00828	RDCH-011-20021	RDTH-031-20021	RDRY-704-00093	5
0.3260 - 0.3461	8.28 - 8.79	3	RDKH-230-00828	RDKH-130-00828	RDCH-011-30021	RDTH-031-30021	RDRY-704-00093	5

**NOTE:** Each roller burnishing tool comes assembled complete with cage, cone, and rolls.

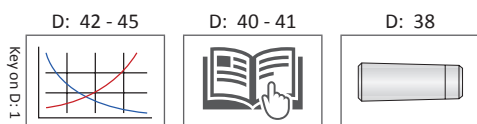



## Roller Burnishing Tools | Through Holes (continued)

H Series | Diameter Range: 0.1850" - 0.5028" (4.70mm - 12.77mm)

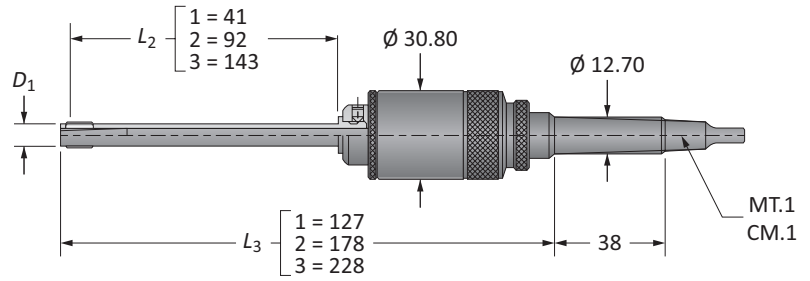

$D_1$		L	Part No.		Spare Parts			Qty Rolls
Imperial (in)	Metric (mm)		Assembly with Morse Taper Shank	Assembly with Straight Shank	Cage	Cone	Rolls	
0.3410 - 0.3606	8.66 - 9.16	1	RDKH-210-00866	RDKH-110-00866	RDCH-011-10022	RDTH-031-10019	RDRY-704-00109	5
0.3410 - 0.3606	8.66 - 9.16	2	RDKH-220-00866	RDKH-120-00866	RDCH-011-20022	RDTH-031-20019	RDRY-704-00109	5
0.3410 - 0.3606	8.66 - 9.16	3	RDKH-230-00866	RDKH-130-00866	RDCH-011-30022	RDTH-031-30019	RDRY-704-00109	5
0.3567 - 0.3768	9.06 - 9.57	1	RDKH-210-00906	RDKH-110-00906	RDCH-011-10023	RDTH-031-10021	RDRY-704-00109	5
0.3567 - 0.3768	9.06 - 9.57	2	RDKH-220-00906	RDKH-120-00906	RDCH-011-20023	RDTH-031-20021	RDRY-704-00109	5
0.3567 - 0.3768	9.06 - 9.57	3	RDKH-230-00906	RDKH-130-00906	RDCH-011-30023	RDTH-031-30021	RDRY-704-00109	5
0.3732 - 0.3933	9.48 - 9.99	1	RDKH-210-00948	RDKH-110-00948	RDCH-011-10024	RDTH-031-10024	RDRY-704-00109	5
0.3732 - 0.3933	9.48 - 9.99	2	RDKH-220-00948	RDKH-120-00948	RDCH-011-20024	RDTH-031-20024	RDRY-704-00109	5
0.3732 - 0.3933	9.48 - 9.99	3	RDKH-230-00948	RDKH-130-00948	RDCH-011-30024	RDTH-031-30024	RDRY-704-00109	5
0.3902 - 0.4102	9.91 - 10.42	1	RDKH-210-00991	RDKH-110-00991	RDCH-011-10025	RDTH-031-10025	RDRY-704-00109	5
0.3902 - 0.4102	9.91 - 10.42	2	RDKH-220-00991	RDKH-120-00991	RDCH-011-20025	RDTH-031-20025	RDRY-704-00109	5
0.3902 - 0.4102	9.91 - 10.42	3	RDKH-230-00991	RDKH-130-00991	RDCH-011-30025	RDTH-031-30025	RDRY-704-00109	5
0.4051 - 0.4252	10.29 - 10.80	1	RDKH-210-01029	RDKH-110-01029	RDCH-011-10026	RDTH-031-10024	RDRY-704-00125	5
0.4051 - 0.4252	10.29 - 10.80	2	RDKH-220-01029	RDKH-120-01029	RDCH-011-20026	RDTH-031-20024	RDRY-704-00125	5
0.4051 - 0.4252	10.29 - 10.80	3	RDKH-230-01029	RDKH-130-01029	RDCH-011-30026	RDTH-031-30024	RDRY-704-00125	5
0.4217 - 0.4413	10.71 - 11.21	1	RDKH-210-01071	RDKH-110-01071	RDCH-011-10027	RDTH-031-10025	RDRY-704-00125	5
0.4217 - 0.4413	10.71 - 11.21	2	RDKH-220-01071	RDKH-120-01071	RDCH-011-20027	RDTH-031-20025	RDRY-704-00125	5
0.4217 - 0.4413	10.71 - 11.21	3	RDKH-230-01071	RDKH-130-01071	RDCH-011-30027	RDTH-031-30025	RDRY-704-00125	5
0.4374 - 0.4571	11.11 - 11.61	1	RDKH-210-01111	RDKH-110-01111	RDCH-011-10028	RDTH-031-10028	RDRY-704-00125	5
0.4374 - 0.4571	11.11 - 11.61	2	RDKH-220-01111	RDKH-120-01111	RDCH-011-20028	RDTH-031-20028	RDRY-704-00125	5
0.4374 - 0.4571	11.11 - 11.61	3	RDKH-230-01111	RDKH-130-01111	RDCH-011-30028	RDTH-031-30028	RDRY-704-00125	5
0.4512 - 0.4709	11.46 - 11.96	1	RDKH-210-01146	RDKH-110-01146	RDCH-011-10029	RDTH-031-10024	RDRY-704-00148	5
0.4512 - 0.4709	11.46 - 11.96	2	RDKH-220-01146	RDKH-120-01146	RDCH-011-20029	RDTH-031-20024	RDRY-704-00148	5
0.4512 - 0.4709	11.46 - 11.96	3	RDKH-230-01146	RDKH-130-01146	RDCH-011-30029	RDTH-031-30024	RDRY-704-00148	5
0.4681 - 0.4878	11.89 - 12.39	1	RDKH-210-01189	RDKH-110-01189	RDCH-011-10030	RDTH-031-10025	RDRY-704-00148	5
0.4681 - 0.4878	11.89 - 12.39	2	RDKH-220-01189	RDKH-120-01189	RDCH-011-20030	RDTH-031-20025	RDRY-704-00148	5
0.4681 - 0.4878	11.89 - 12.39	3	RDKH-230-01189	RDKH-130-01189	RDCH-011-30030	RDTH-031-30025	RDRY-704-00148	5
0.4831 - 0.5028	12.27 - 12.77	1	RDKH-210-01227	RDKH-110-01227	RDCH-011-10031	RDTH-031-10028	RDRY-704-00148	5
0.4831 - 0.5028	12.27 - 12.77	2	RDKH-220-01227	RDKH-120-01227	RDCH-011-20031	RDTH-031-20028	RDRY-704-00148	5
0.4831 - 0.5028	12.27 - 12.77	3	RDKH-230-01227	RDKH-130-01227	RDCH-011-30031	RDTH-031-30028	RDRY-704-00148	5

**NOTE:** Each roller burnishing tool comes assembled complete with cage, cone, and rolls.

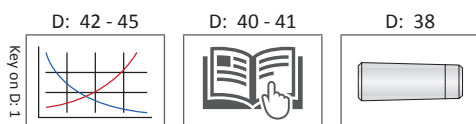

H  
A  
DRILLING  
B  
BORING  
C  
REAMING  
D  
BURNISHING  
E  
THREADING  
X  
SPECIALS

## Roller Burnishing Tools | Blind Holes

H Series | Diameter Range: 0.2319" - 0.5028" (5.89mm - 12.77mm)

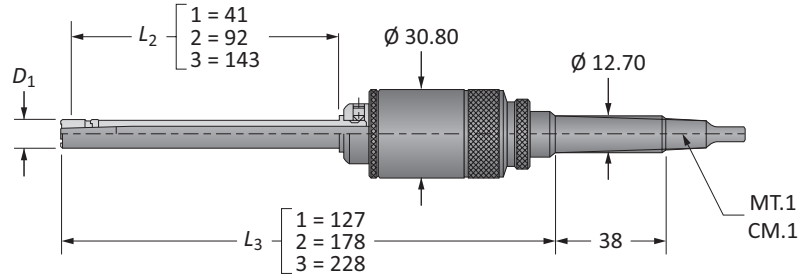

$D_1$		$L$	Part No.*		Spare Parts			Qty Rolls
Imperial (in)	Metric (mm)		Assembly with Morse Taper Shank	Assembly with Straight Shank	Cage	Cone**	Rolls	
0.2319 - 0.2524	5.89 - 6.41	1	RSKH-210-xxxxx	RSKH-110-xxxxx	RSCH-015-10015	RSTH-03x-10012	RSRY-708-00086	3
0.2319 - 0.2524	5.89 - 6.41	2	RSKH-220-xxxxx	RSKH-120-xxxxx	RSCH-015-20015	RSTH-03x-20012	RSRY-708-00086	3
0.2319 - 0.2524	5.89 - 6.41	3	RSKH-230-xxxxx	RSKH-130-xxxxx	RSCH-015-30015	RSTH-03x-30012	RSRY-708-00086	3
0.2484 - 0.2681	6.31 - 6.81	1	RSKH-210-xxxxx	RSKH-110-xxxxx	RSCH-015-10016	RSTH-03x-10013	RSRY-708-00086	3
0.2484 - 0.2681	6.31 - 6.81	2	RSKH-220-xxxxx	RSKH-120-xxxxx	RSCH-015-20016	RSTH-03x-20013	RSRY-708-00086	3
0.2484 - 0.2681	6.31 - 6.81	3	RSKH-230-xxxxx	RSKH-130-xxxxx	RSCH-015-30016	RSTH-03x-30013	RSRY-708-00086	3
0.2642 - 0.2839	6.71 - 7.21	1	RSKH-210-xxxxx	RSKH-110-xxxxx	RSCH-015-10017	RSTH-03x-10015	RSRY-708-00086	3
0.2642 - 0.2839	6.71 - 7.21	2	RSKH-220-xxxxx	RSKH-120-xxxxx	RSCH-015-20017	RSTH-03x-20015	RSRY-708-00086	3
0.2642 - 0.2839	6.71 - 7.21	3	RSKH-230-xxxxx	RSKH-130-xxxxx	RSCH-015-30017	RSTH-03x-30015	RSRY-708-00086	3
0.2803 - 0.3000	7.12 - 7.62	1	RSKH-210-xxxxx	RSKH-110-xxxxx	RSCH-015-10018	RSTH-03x-10017	RSRY-708-00086	3
0.2803 - 0.3000	7.12 - 7.62	2	RSKH-220-xxxxx	RSKH-120-xxxxx	RSCH-015-20018	RSTH-03x-20017	RSRY-708-00086	3
0.2803 - 0.3000	7.12 - 7.62	3	RSKH-230-xxxxx	RSKH-130-xxxxx	RSCH-015-30018	RSTH-03x-30017	RSRY-708-00086	3
0.2945 - 0.3142	7.48 - 7.98	1	RSKH-210-xxxxx	RSKH-110-xxxxx	RSCH-015-10019	RSTH-03x-10019	RSRY-708-00086	3
0.2945 - 0.3142	7.48 - 7.98	2	RSKH-220-xxxxx	RSKH-120-xxxxx	RSCH-015-20019	RSTH-03x-20019	RSRY-708-00086	3
0.2945 - 0.3142	7.48 - 7.98	3	RSKH-230-xxxxx	RSKH-130-xxxxx	RSCH-015-30019	RSTH-03x-30019	RSRY-708-00086	3
0.3102 - 0.3299	7.88 - 8.38	1	RSKH-210-xxxxx	RSKH-110-xxxxx	RSCH-015-10020	RSTH-03x-10021	RSRY-708-00086	3
0.3102 - 0.3299	7.88 - 8.38	2	RSKH-220-xxxxx	RSKH-120-xxxxx	RSCH-015-20020	RSTH-03x-20021	RSRY-708-00086	3
0.3102 - 0.3299	7.88 - 8.38	3	RSKH-230-xxxxx	RSKH-130-xxxxx	RSCH-015-30020	RSTH-03x-30021	RSRY-708-00086	3
0.3260 - 0.3461	8.28 - 8.79	1	RSKH-210-xxxxx	RSKH-110-xxxxx	RSCH-015-10021	RSTH-03x-10024	RSRY-708-00086	3
0.3260 - 0.3461	8.28 - 8.79	2	RSKH-220-xxxxx	RSKH-120-xxxxx	RSCH-015-20021	RSTH-03x-20024	RSRY-708-00086	3
0.3260 - 0.3461	8.28 - 8.79	3	RSKH-230-xxxxx	RSKH-130-xxxxx	RSCH-015-30021	RSTH-03x-30024	RSRY-708-00086	3
0.3410 - 0.3606	8.66 - 9.16	1	RSKH-210-xxxxx	RSKH-110-xxxxx	RSCH-015-10022	RSTH-03x-10015	RSRY-708-00125	3
0.3410 - 0.3606	8.66 - 9.16	2	RSKH-220-xxxxx	RSKH-120-xxxxx	RSCH-015-20022	RSTH-03x-20015	RSRY-708-00125	3
0.3410 - 0.3606	8.66 - 9.16	3	RSKH-230-xxxxx	RSKH-130-xxxxx	RSCH-015-30022	RSTH-03x-30015	RSRY-708-00125	3
0.3567 - 0.3768	9.06 - 9.57	1	RSKH-210-xxxxx	RSKH-110-xxxxx	RSCH-015-10023	RSTH-03x-10017	RSRY-708-00125	3
0.3567 - 0.3768	9.06 - 9.57	2	RSKH-220-xxxxx	RSKH-120-xxxxx	RSCH-015-20023	RSTH-03x-20017	RSRY-708-00125	3
0.3567 - 0.3768	9.06 - 9.57	3	RSKH-230-xxxxx	RSKH-130-xxxxx	RSCH-015-30023	RSTH-03x-30017	RSRY-708-00125	3

\*xxxxx = Indicate to 2 metric decimal places the size to be burnished (e.g. short series roller burnisher  $\varnothing 10.25\text{mm}$  with MT.1 shank: RSKH-210-01025).

\*\*x = A number that will vary from 2 to 8 depending upon the exact diameter to be burnished. See page D: 6 for the correct identification of the "x" value.

**NOTE:** Each roller burnishing tool comes assembled complete with cage, cone, and rolls.

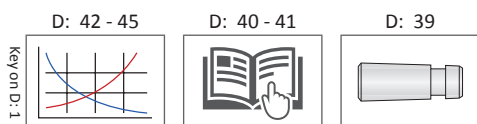



## Roller Burnishing Tools | Blind Holes (continued)

H Series | Diameter Range: 0.2319" - 0.5028" (5.89mm - 12.77mm)

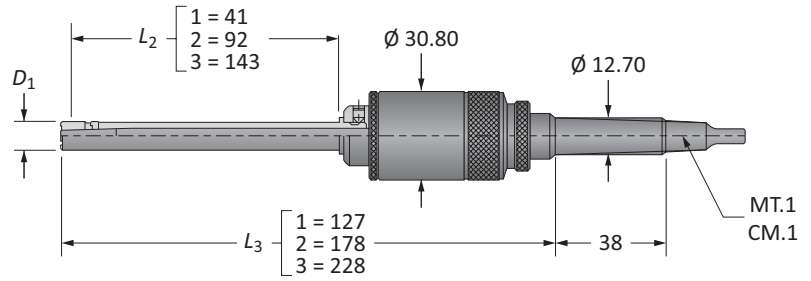

D <sub>1</sub>		L	Part No.*		Spare Parts			Qty Rolls
Imperial (in)	Metric (mm)		Assembly with Morse Taper Shank	Assembly with Straight Shank	Cage	Cone**	Rolls	
0.3732 - 0.3933	9.48 - 9.99	1	RSKH-210-xxxxx	RSKH-110-xxxxx	RSCH-015-10024	RSTH-03x-10019	RSRY-708-00125	3
0.3732 - 0.3933	9.48 - 9.99	2	RSKH-220-xxxxx	RSKH-120-xxxxx	RSCH-015-20024	RSTH-03x-20019	RSRY-708-00125	3
0.3732 - 0.3933	9.48 - 9.99	3	RSKH-230-xxxxx	RSKH-130-xxxxx	RSCH-015-30024	RSTH-03x-30019	RSRY-708-00125	3
0.3902 - 0.4102	9.91 - 10.42	1	RSKH-210-xxxxx	RSKH-110-xxxxx	RSCH-015-10025	RSTH-03x-10021	RSRY-708-00125	3
0.3902 - 0.4102	9.91 - 10.42	2	RSKH-220-xxxxx	RSKH-120-xxxxx	RSCH-015-20025	RSTH-03x-20021	RSRY-708-00125	3
0.3902 - 0.4102	9.91 - 10.42	3	RSKH-230-xxxxx	RSKH-130-xxxxx	RSCH-015-30025	RSTH-03x-30021	RSRY-708-00125	3
0.4051 - 0.4252	10.29 - 10.80	1	RSKH-210-xxxxx	RSKH-110-xxxxx	RSCH-015-10026	RSTH-03x-10024	RSRY-708-00125	3
0.4051 - 0.4252	10.29 - 10.80	2	RSKH-220-xxxxx	RSKH-120-xxxxx	RSCH-015-20026	RSTH-03x-20024	RSRY-708-00125	3
0.4051 - 0.4252	10.29 - 10.80	3	RSKH-230-xxxxx	RSKH-130-xxxxx	RSCH-015-30026	RSTH-03x-30024	RSRY-708-00125	3
0.4217 - 0.4413	10.71 - 11.21	1	RSKH-210-xxxxx	RSKH-110-xxxxx	RSCH-015-10027	RSTH-03x-10025	RSRY-708-00125	3
0.4217 - 0.4413	10.71 - 11.21	2	RSKH-220-xxxxx	RSKH-120-xxxxx	RSCH-015-20027	RSTH-03x-20025	RSRY-708-00125	3
0.4217 - 0.4413	10.71 - 11.21	3	RSKH-230-xxxxx	RSKH-130-xxxxx	RSCH-015-30027	RSTH-03x-30025	RSRY-708-00125	3
0.4374 - 0.4571	11.11 - 11.61	1	RSKH-210-xxxxx	RSKH-110-xxxxx	RSCH-015-10028	RSTH-03x-10028	RSRY-708-00125	3
0.4374 - 0.4571	11.11 - 11.61	2	RSKH-220-xxxxx	RSKH-120-xxxxx	RSCH-015-20028	RSTH-03x-20028	RSRY-708-00125	3
0.4374 - 0.4571	11.11 - 11.61	3	RSKH-230-xxxxx	RSKH-130-xxxxx	RSCH-015-30028	RSTH-03x-30028	RSRY-708-00125	3
0.4512 - 0.4709	11.46 - 11.96	1	RSKH-210-xxxxx	RSKH-110-xxxxx	RSCH-015-10029	RSTH-03x-10021	RSRY-708-00156	3
0.4512 - 0.4709	11.46 - 11.96	2	RSKH-220-xxxxx	RSKH-120-xxxxx	RSCH-015-20029	RSTH-03x-20021	RSRY-708-00156	3
0.4512 - 0.4709	11.46 - 11.96	3	RSKH-230-xxxxx	RSKH-130-xxxxx	RSCH-015-30029	RSTH-03x-30021	RSRY-708-00156	3
0.4681 - 0.4878	11.89 - 12.39	1	RSKH-210-xxxxx	RSKH-110-xxxxx	RSCH-015-10030	RSTH-03x-10024	RSRY-708-00156	3
0.4681 - 0.4878	11.89 - 12.39	2	RSKH-220-xxxxx	RSKH-120-xxxxx	RSCH-015-20030	RSTH-03x-20024	RSRY-708-00156	3
0.4681 - 0.4878	11.89 - 12.39	3	RSKH-230-xxxxx	RSKH-130-xxxxx	RSCH-015-30030	RSTH-03x-30024	RSRY-708-00156	3
0.4831 - 0.5028	12.27 - 12.77	1	RSKH-210-xxxxx	RSKH-110-xxxxx	RSCH-015-10031	RSTH-03x-10025	RSRY-708-00156	3
0.4831 - 0.5028	12.27 - 12.77	2	RSKH-220-xxxxx	RSKH-120-xxxxx	RSCH-015-20031	RSTH-03x-20025	RSRY-708-00156	3
0.4831 - 0.5028	12.27 - 12.77	3	RSKH-230-xxxxx	RSKH-130-xxxxx	RSCH-015-30031	RSTH-03x-30025	RSRY-708-00156	3

\*xxxxx = Indicate to 2 metric decimal places the size to be burnished (e.g. short series roller burnisher Ø 10.25mm with MT.1 shank: RSKH-210-01025).

\*\*x = A number that will vary from 2 to 8 depending upon the exact diameter to be burnished. See page D: 6 for the correct identification of the "x" value.

**NOTE:** Each roller burnishing tool comes assembled complete with cage, cone, and rolls.

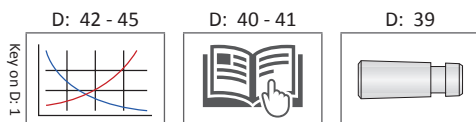

A DRILLING  
B BORING  
C REAMING  
D BURNISHING  
E THREADING  
X SPECIALS

## Roller Burnishing Tools | Through Holes

I Series | Diameter Range: 0.4976" - 0.6634" (12.64mm - 16.85mm)

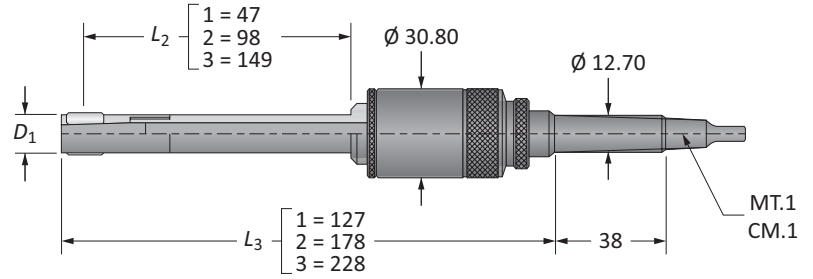

D <sub>1</sub>		L	Part No.		Spare Parts			Qty Rolls
Imperial (in)	Metric (mm)		Assembly with Morse Taper Shank	Assembly with Straight Shank	Cage	Cone	Rolls	
0.4976 - 0.5315	12.64 - 13.50	1	RDKI-210-01264	RDKI-110-01264	RDCI-400-00500	RDTI-031-10032	RDRY-704-00156	5
0.4976 - 0.5315	12.64 - 13.50	2	RDKI-220-01264	RDKI-120-01264	RDCI-400-00500	RDTI-031-20032	RDRY-704-00156	5
0.4976 - 0.5315	12.64 - 13.50	3	RDKI-230-01264	RDKI-130-01264	RDCI-400-00500	RDTI-031-30032	RDRY-704-00156	5
0.5295 - 0.5689	13.45 - 14.45	1	RDKI-210-01345	RDKI-110-01345	RDCI-400-00531	RDTI-031-10034	RDRY-704-00156	5
0.5295 - 0.5689	13.45 - 14.45	2	RDKI-220-01345	RDKI-120-01345	RDCI-400-00531	RDTI-031-20034	RDRY-704-00156	5
0.5295 - 0.5689	13.45 - 14.45	3	RDKI-230-01345	RDKI-130-01345	RDCI-400-00531	RDTI-031-30034	RDRY-704-00156	5
0.5610 - 0.6004	14.25 - 15.25	1	RDKI-210-01425	RDKI-110-01425	RDCI-400-00562	RDTI-031-10034	RDRY-704-00172	5
0.5610 - 0.6004	14.25 - 15.25	2	RDKI-220-01425	RDKI-120-01425	RDCI-400-00562	RDTI-031-20034	RDRY-704-00172	5
0.5610 - 0.6004	14.25 - 15.25	3	RDKI-230-01425	RDKI-130-01425	RDCI-400-00562	RDTI-031-30034	RDRY-704-00172	5
0.5925 - 0.6319	15.05 - 16.05	1	RDKI-210-01505	RDKI-110-01505	RDCI-400-00593	RDTI-031-10038	RDRY-704-00172	5
0.5925 - 0.6319	15.05 - 16.05	2	RDKI-220-01505	RDKI-120-01505	RDCI-400-00593	RDTI-031-20038	RDRY-704-00172	5
0.5925 - 0.6319	15.05 - 16.05	3	RDKI-230-01505	RDKI-130-01505	RDCI-400-00593	RDTI-031-30038	RDRY-704-00172	5
0.6240 - 0.6634	15.85 - 16.85	1	RDKI-210-01585	RDKI-110-01585	RDCI-400-00625	RDTI-031-10038	RDRY-701-00187	5
0.6240 - 0.6634	15.85 - 16.85	2	RDKI-220-01585	RDKI-120-01585	RDCI-400-00625	RDTI-031-20038	RDRY-701-00187	5
0.6240 - 0.6634	15.85 - 16.85	3	RDKI-230-01585	RDKI-130-01585	RDCI-400-00625	RDTI-031-30038	RDRY-701-00187	5

**NOTE:** Each roller burnishing tool comes assembled complete with cage, cone, and rolls.

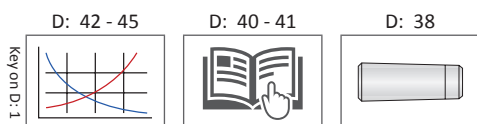



## Roller Burnishing Tools | Blind Holes

I Series | Diameter Range: 0.4976" - 0.6634" (12.64mm - 16.85mm)

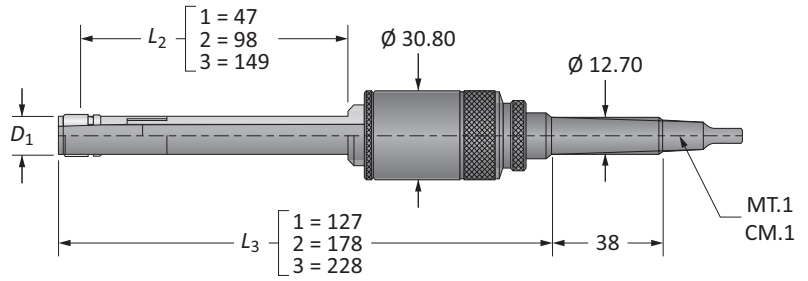

D <sub>1</sub>		L	Part No.*		Spare Parts			Qty Rolls
Imperial (in)	Metric (mm)		Assembly with Morse Taper Shank	Assembly with Straight Shank	Cage	Cone**	Rolls	
0.4976 - 0.5315	12.64 - 13.50	1	RSKI-210-xxxxx	RSKI-110-xxxxx	RSCI-400-00500	RSTI-03X-10032	RSRY-708-00156	5
0.4976 - 0.5315	12.64 - 13.50	2	RSKI-220-xxxxx	RSKI-120-xxxxx	RSCI-400-00500	RSTI-03X-20032	RSRY-708-00156	5
0.4976 - 0.5315	12.64 - 13.50	3	RSKI-230-xxxxx	RSKI-130-xxxxx	RSCI-400-00500	RSTI-03X-30032	RSRY-708-00156	5
0.5295 - 0.5689	13.45 - 14.45	1	RSKI-210-xxxxx	RSKI-110-xxxxx	RSCI-400-00531	RSTI-03X-10034	RSRY-708-00156	5
0.5295 - 0.5689	13.45 - 14.45	2	RSKI-220-xxxxx	RSKI-120-xxxxx	RSCI-400-00531	RSTI-03X-20034	RSRY-708-00156	5
0.5295 - 0.5689	13.45 - 14.45	3	RSKI-230-xxxxx	RSKI-130-xxxxx	RSCI-400-00531	RSTI-03X-30034	RSRY-708-00156	5
0.5610 - 0.6004	14.25 - 15.25	1	RSKI-210-xxxxx	RSKI-110-xxxxx	RSCI-400-00562	RSTI-03X-10034	RSRY-708-00172	5
0.5610 - 0.6004	14.25 - 15.25	2	RSKI-220-xxxxx	RSKI-120-xxxxx	RSCI-400-00562	RSTI-03X-20034	RSRY-708-00172	5
0.5610 - 0.6004	14.25 - 15.25	3	RSKI-230-xxxxx	RSKI-130-xxxxx	RSCI-400-00562	RSTI-03X-30034	RSRY-708-00172	5
0.5925 - 0.6319	15.05 - 16.05	1	RSKI-210-xxxxx	RSKI-110-xxxxx	RSCI-400-00593	RSTI-03X-10038	RSRY-708-00172	5
0.5925 - 0.6319	15.05 - 16.05	2	RSKI-220-xxxxx	RSKI-120-xxxxx	RSCI-400-00593	RSTI-03X-20038	RSRY-708-00172	5
0.5925 - 0.6319	15.05 - 16.05	3	RSKI-230-xxxxx	RSKI-130-xxxxx	RSCI-400-00593	RSTI-03X-30038	RSRY-708-00172	5
0.6240 - 0.6634	15.85 - 16.85	1	RSKI-210-xxxxx	RSKI-110-xxxxx	RSCI-400-00625	RSTI-03X-10038	RSRY-708-00187	5
0.6240 - 0.6634	15.85 - 16.85	2	RSKI-220-xxxxx	RSKI-120-xxxxx	RSCI-400-00625	RSTI-03X-20038	RSRY-708-00187	5
0.6240 - 0.6634	15.85 - 16.85	3	RSKI-230-xxxxx	RSKI-130-xxxxx	RSCI-400-00625	RSTI-03X-30038	RSRY-708-00187	5

\*xxxxx = Indicate to 2 metric decimal places the size to be burnished (e.g. long series roller burnisher Ø 14.00mm with MT.1 shank: RSKI-230-01400).

\*\*x = A number that will vary from 2 to 8 depending upon the exact diameter to be burnished. See page D: 6 for the correct identification of the "x" value.

**NOTE:** Each roller burnishing tool comes assembled complete with cage, cone, and rolls.

D: 42 - 45

D: 40 - 41

D: 39

Key on D: 1

A DRILLING  
B BORING  
C REAMING  
D BURNISHING  
E THREADING  
X SPECIALS

K



 BURNISHING | S.C.A.M.I.® Roller Burnishing Systems

A

## Roller Burnishing Tools | Through Holes

K Series | Diameter Range: 0.6535" - 0.9740" (16.60mm - 24.74mm)

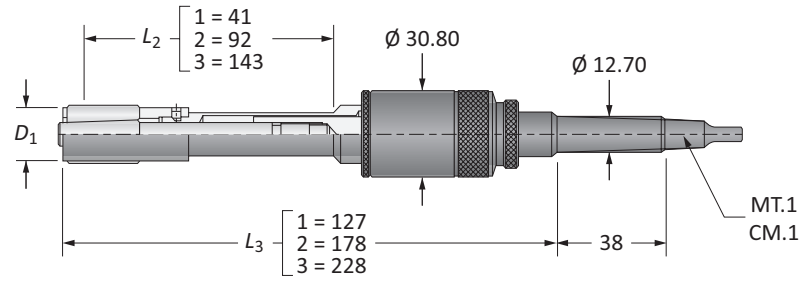
DRILLING

Technical drawing showing dimensions for the roller burnishing tool assembly:

- Roll length options: 1 = 41, 2 = 92, 3 = 143
- Roll diameter:  $\varnothing 30.80$
- Roll diameter:  $\varnothing 12.70$
- Roll length: 38
- Shank diameter:  $D_1$
- Shank length options: 1 = 127, 2 = 178, 3 = 228
- Shank type: MT.1 CM.1

B

BORING

$D_1$		$L$	Part No.		Spare Parts			Qty Rolls
Imperial (in)	Metric (mm)		Assembly with Morse Taper Shank	Assembly with Straight Shank	Cage	Cone	Rolls	
0.6535 - 0.6933	16.60 - 17.61	1	RDKK-210-01660	RDKK-110-01660	RDCK-011-00042	RDTK-031-00042	RDRY-701-00187	5
0.6535 - 0.6933	16.60 - 17.61	2	RDKK-220-01660	RDKK-120-01660	RDCK-011-00042	RDTK-031-00042	RDRY-701-00187	5
0.6535 - 0.6933	16.60 - 17.61	3	RDKK-230-01660	RDKK-130-01660	RDCK-011-00042	RDTK-031-00042	RDRY-701-00187	5
0.6850 - 0.7240	17.40 - 18.39	1	RDKK-210-01740	RDKK-110-01740	RDCK-011-00044	RDTK-031-00044	RDRY-701-00187	5
0.6850 - 0.7240	17.40 - 18.39	2	RDKK-220-01740	RDKK-120-01740	RDCK-011-00044	RDTK-031-00044	RDRY-701-00187	5
0.6850 - 0.7240	17.40 - 18.39	3	RDKK-230-01740	RDKK-130-01740	RDCK-011-00044	RDTK-031-00044	RDRY-701-00187	5
0.7161 - 0.7551	18.19 - 19.18	1	RDKK-210-01819	RDKK-110-01819	RDCK-011-00046	RDTK-031-00042	RDRY-701-00218	5
0.7161 - 0.7551	18.19 - 19.18	2	RDKK-220-01819	RDKK-120-01819	RDCK-011-00046	RDTK-031-00042	RDRY-701-00218	5
0.7161 - 0.7551	18.19 - 19.18	3	RDKK-230-01819	RDKK-130-01819	RDCK-011-00046	RDTK-031-00042	RDRY-701-00218	5
0.7465 - 0.7870	18.96 - 19.99	1	RDKK-210-01896	RDKK-110-01896	RDCK-011-00048	RDTK-031-00044	RDRY-701-00218	5
0.7465 - 0.7870	18.96 - 19.99	2	RDKK-220-01896	RDKK-120-01896	RDCK-011-00048	RDTK-031-00044	RDRY-701-00218	5
0.7465 - 0.7870	18.96 - 19.99	3	RDKK-230-01896	RDKK-130-01896	RDCK-011-00048	RDTK-031-00044	RDRY-701-00218	5
0.7772 - 0.8177	19.74 - 20.77	1	RDKK-210-01974	RDKK-110-01974	RDCK-011-00050	RDTK-031-00050	RDRY-701-00218	5
0.7772 - 0.8177	19.74 - 20.77	2	RDKK-220-01974	RDKK-120-01974	RDCK-011-00050	RDTK-031-00050	RDRY-701-00218	5
0.7772 - 0.8177	19.74 - 20.77	3	RDKK-230-01974	RDKK-130-01974	RDCK-011-00050	RDTK-031-00050	RDRY-701-00218	5
0.8079 - 0.8492	20.52 - 21.57	1	RDKK-210-02052	RDKK-110-02052	RDCK-011-00052	RDTK-031-00052	RDRY-701-00218	5
0.8079 - 0.8492	20.52 - 21.57	2	RDKK-220-02052	RDKK-120-02052	RDCK-011-00052	RDTK-031-00052	RDRY-701-00218	5
0.8079 - 0.8492	20.52 - 21.57	3	RDKK-230-02052	RDKK-130-02052	RDCK-011-00052	RDTK-031-00052	RDRY-701-00218	5
0.8390 - 0.8799	21.31 - 22.35	1	RDKK-210-02131	RDKK-110-02131	RDCK-011-00054	RDTK-031-00054	RDRY-701-00218	5
0.8390 - 0.8799	21.31 - 22.35	2	RDKK-220-02131	RDKK-120-02131	RDCK-011-00054	RDTK-031-00054	RDRY-701-00218	5
0.8390 - 0.8799	21.31 - 22.35	3	RDKK-230-02131	RDKK-130-02131	RDCK-011-00054	RDTK-031-00054	RDRY-701-00218	5
0.8713 - 0.9118	22.13 - 23.16	1	RDKK-210-02213	RDKK-110-02213	RDCK-011-00056	RDTK-031-00050	RDRY-701-00265	5
0.8713 - 0.9118	22.13 - 23.16	2	RDKK-220-02213	RDKK-120-02213	RDCK-011-00056	RDTK-031-00050	RDRY-701-00265	5
0.8713 - 0.9118	22.13 - 23.16	3	RDKK-230-02213	RDKK-130-02213	RDCK-011-00056	RDTK-031-00050	RDRY-701-00265	5
0.9020 - 0.9433	22.91 - 23.96	1	RDKK-210-02291	RDKK-110-02291	RDCK-011-00058	RDTK-031-00052	RDRY-701-00265	5
0.9020 - 0.9433	22.91 - 23.96	2	RDKK-220-02291	RDKK-120-02291	RDCK-011-00058	RDTK-031-00052	RDRY-701-00265	5
0.9020 - 0.9433	22.91 - 23.96	3	RDKK-230-02291	RDKK-130-02291	RDCK-011-00058	RDTK-031-00052	RDRY-701-00265	5
0.9331 - 0.9740	23.70 - 24.74	1	RDKK-210-02370	RDKK-110-02370	RDCK-011-00060	RDTK-031-00054	RDRY-701-00265	5
0.9331 - 0.9740	23.70 - 24.74	2	RDKK-220-02370	RDKK-120-02370	RDCK-011-00060	RDTK-031-00054	RDRY-701-00265	5
0.9331 - 0.9740	23.70 - 24.74	3	RDKK-230-02370	RDKK-130-02370	RDCK-011-00060	RDTK-031-00054	RDRY-701-00265	5

**NOTE:** Each roller burnishing tool comes assembled complete with cage, cone, and rolls.

REAMING



BURNISHING

THREADING

X

SPECIALS

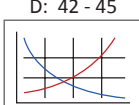
Key on D: 1

D: 14

[www.alliedmachine.com](http://www.alliedmachine.com) | 1.330.343.4283





## Roller Burnishing Tools | Blind Holes

K Series | Diameter Range: 0.6535" - 0.9740" (16.60mm - 24.74mm)

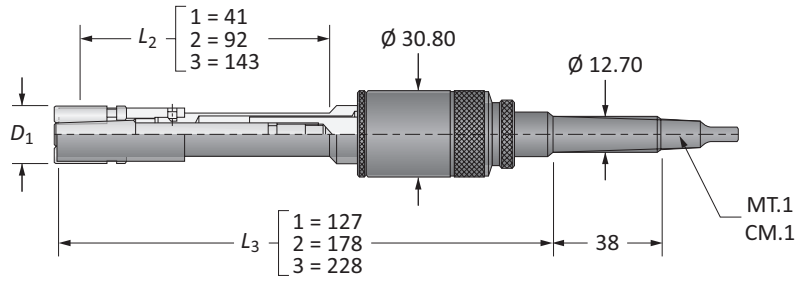

D <sub>1</sub>		L	Part No.*		Spare Parts			Qty Rolls
Imperial (in)	Metric (mm)		Assembly with Morse Taper Shank	Assembly with Straight Shank	Cage	Cone**	Rolls	
0.6535 - 0.6933	16.60 - 17.61	1	RSKK-210-xxxxx	RSKK-110-xxxxx	RSCK-015-00042	RSTK-03x-00042	RSRY-708-00187	5
0.6535 - 0.6933	16.60 - 17.61	2	RSKK-220-xxxxx	RSKK-120-xxxxx	RSCK-015-00042	RSTK-03x-00042	RSRY-708-00187	5
0.6535 - 0.6933	16.60 - 17.61	3	RSKK-230-xxxxx	RSKK-130-xxxxx	RSCK-015-00042	RSTK-03x-00042	RSRY-708-00187	5
0.6850 - 0.7240	17.40 - 18.39	1	RSKK-210-xxxxx	RSKK-110-xxxxx	RSCK-015-00044	RSTK-03x-00044	RSRY-708-00187	5
0.6850 - 0.7240	17.40 - 18.39	2	RSKK-220-xxxxx	RSKK-120-xxxxx	RSCK-015-00044	RSTK-03x-00044	RSRY-708-00187	5
0.6850 - 0.7240	17.40 - 18.39	3	RSKK-230-xxxxx	RSKK-130-xxxxx	RSCK-015-00044	RSTK-03x-00044	RSRY-708-00187	5
0.7161 - 0.7551	18.19 - 19.18	1	RSKK-210-xxxxx	RSKK-110-xxxxx	RSCK-015-00046	RSTK-03x-00042	RSRY-708-00218	5
0.7161 - 0.7551	18.19 - 19.18	2	RSKK-220-xxxxx	RSKK-120-xxxxx	RSCK-015-00046	RSTK-03x-00042	RSRY-708-00218	5
0.7161 - 0.7551	18.19 - 19.18	3	RSKK-230-xxxxx	RSKK-130-xxxxx	RSCK-015-00046	RSTK-03x-00042	RSRY-708-00218	5
0.7465 - 0.7870	18.96 - 19.99	1	RSKK-210-xxxxx	RSKK-110-xxxxx	RSCK-015-00048	RSTK-03x-00044	RSRY-708-00218	5
0.7465 - 0.7870	18.96 - 19.99	2	RSKK-220-xxxxx	RSKK-120-xxxxx	RSCK-015-00048	RSTK-03x-00044	RSRY-708-00218	5
0.7465 - 0.7870	18.96 - 19.99	3	RSKK-230-xxxxx	RSKK-130-xxxxx	RSCK-015-00048	RSTK-03x-00044	RSRY-708-00218	5
0.7772 - 0.8177	19.74 - 20.77	1	RSKK-210-xxxxx	RSKK-110-xxxxx	RSCK-015-00050	RSTK-03x-00050	RSRY-708-00218	5
0.7772 - 0.8177	19.74 - 20.77	2	RSKK-220-xxxxx	RSKK-120-xxxxx	RSCK-015-00050	RSTK-03x-00050	RSRY-708-00218	5
0.7772 - 0.8177	19.74 - 20.77	3	RSKK-230-xxxxx	RSKK-130-xxxxx	RSCK-015-00050	RSTK-03x-00050	RSRY-708-00218	5
0.8079 - 0.8492	20.52 - 21.57	1	RSKK-210-xxxxx	RSKK-110-xxxxx	RSCK-015-00052	RSTK-03x-00052	RSRY-708-00218	5
0.8079 - 0.8492	20.52 - 21.57	2	RSKK-220-xxxxx	RSKK-120-xxxxx	RSCK-015-00052	RSTK-03x-00052	RSRY-708-00218	5
0.8079 - 0.8492	20.52 - 21.57	3	RSKK-230-xxxxx	RSKK-130-xxxxx	RSCK-015-00052	RSTK-03x-00052	RSRY-708-00218	5
0.8390 - 0.8799	21.31 - 22.35	1	RSKK-210-xxxxx	RSKK-110-xxxxx	RSCK-015-00054	RSTK-03x-00054	RSRY-708-00218	5
0.8390 - 0.8799	21.31 - 22.35	2	RSKK-220-xxxxx	RSKK-120-xxxxx	RSCK-015-00054	RSTK-03x-00054	RSRY-708-00218	5
0.8390 - 0.8799	21.31 - 22.35	3	RSKK-230-xxxxx	RSKK-130-xxxxx	RSCK-015-00054	RSTK-03x-00054	RSRY-708-00218	5
0.8713 - 0.9118	22.13 - 23.16	1	RSKK-210-xxxxx	RSKK-110-xxxxx	RSCK-015-00056	RSTK-03x-00050	RSRY-708-00265	5
0.8713 - 0.9118	22.13 - 23.16	2	RSKK-220-xxxxx	RSKK-120-xxxxx	RSCK-015-00056	RSTK-03x-00050	RSRY-708-00265	5
0.8713 - 0.9118	22.13 - 23.16	3	RSKK-230-xxxxx	RSKK-130-xxxxx	RSCK-015-00056	RSTK-03x-00050	RSRY-708-00265	5
0.9020 - 0.9433	22.91 - 23.96	1	RSKK-210-xxxxx	RSKK-110-xxxxx	RSCK-015-00058	RSTK-03x-00052	RSRY-708-00265	5
0.9020 - 0.9433	22.91 - 23.96	2	RSKK-220-xxxxx	RSKK-120-xxxxx	RSCK-015-00058	RSTK-03x-00052	RSRY-708-00265	5
0.9020 - 0.9433	22.91 - 23.96	3	RSKK-230-xxxxx	RSKK-130-xxxxx	RSCK-015-00058	RSTK-03x-00052	RSRY-708-00265	5
0.9331 - 0.9740	23.70 - 24.74	1	RSKK-210-xxxxx	RSKK-110-xxxxx	RSCK-015-00060	RSTK-03x-00054	RSRY-708-00265	5
0.9331 - 0.9740	23.70 - 24.74	2	RSKK-220-xxxxx	RSKK-120-xxxxx	RSCK-015-00060	RSTK-03x-00054	RSRY-708-00265	5
0.9331 - 0.9740	23.70 - 24.74	3	RSKK-230-xxxxx	RSKK-130-xxxxx	RSCK-015-00060	RSTK-03x-00054	RSRY-708-00265	5

\*xxxxx = Indicate to 2 metric decimal places the size to be burnished (e.g. standard series roller burnisher Ø 20.00mm with MT.1 shank: RSKK-120-02000).

\*\*x = A number that will vary from 2 to 8 depending upon the exact diameter to be burnished. See page D: 6 for the correct identification of the "x" value.

**NOTE:** Each roller burnishing tool comes assembled complete with cage, cone, and rolls.

D: 42 - 45

D: 40 - 41

D: 39

Key on D: 1

## Roller Burnishing Tools | Through Holes

L Series | Diameter Range: 0.9661" - 1.2268" (24.54mm - 31.16mm)

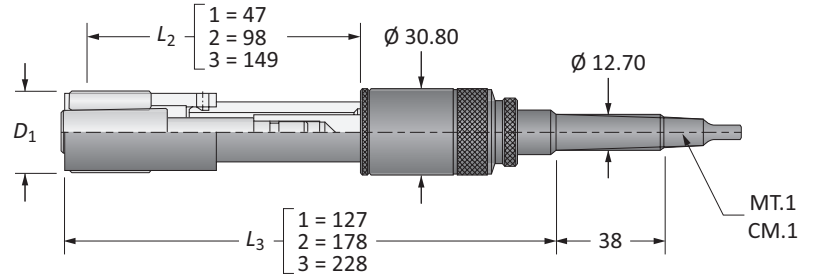

D <sub>1</sub>		L	Part No.		Spare Parts			Qty Rolls
Imperial (in)	Metric (mm)		Assembly with Morse Taper Shank	Assembly with Straight Shank	Cage	Cone	Rolls	
0.9661 - 1.0075	24.54 - 25.59	1	<b>RDKL-210-02454</b>	<b>RDKL-110-02454</b>	RDCL-011-00062	RDTL-031-00062	RDRY-701-00265	5
0.9661 - 1.0075	24.54 - 25.59	2	<b>RDKL-220-02454</b>	<b>RDKL-120-02454</b>	RDCL-011-00062	RDTL-031-00062	RDRY-701-00265	5
0.9661 - 1.0075	24.54 - 25.59	3	<b>RDKL-230-02454</b>	<b>RDKL-130-02454</b>	RDCL-011-00062	RDTL-031-00062	RDRY-701-00265	5
0.9992 - 1.0402	25.38 - 26.42	1	<b>RDKL-210-02538</b>	<b>RDKL-110-02538</b>	RDCL-011-00064	RDTL-031-00064	RDRY-701-00265	7
0.9992 - 1.0402	25.38 - 26.42	2	<b>RDKL-220-02538</b>	<b>RDKL-120-02538</b>	RDCL-011-00064	RDTL-031-00064	RDRY-701-00265	7
0.9992 - 1.0402	25.38 - 26.42	3	<b>RDKL-230-02538</b>	<b>RDKL-130-02538</b>	RDCL-011-00064	RDTL-031-00064	RDRY-701-00265	7
1.0299 - 1.0709	26.16 - 27.20	1	<b>RDKL-210-02616</b>	<b>RDKL-110-02616</b>	RDCL-011-00066	RDTL-031-00066	RDRY-701-00265	7
1.0299 - 1.0709	26.16 - 27.20	2	<b>RDKL-220-02616</b>	<b>RDKL-120-02616</b>	RDCL-011-00066	RDTL-031-00066	RDRY-701-00265	7
1.0299 - 1.0709	26.16 - 27.20	3	<b>RDKL-230-02616</b>	<b>RDKL-130-02616</b>	RDCL-011-00066	RDTL-031-00066	RDRY-701-00265	7
1.0610 - 1.1024	26.95 - 28.00	1	<b>RDKL-210-02695</b>	<b>RDKL-110-02695</b>	RDCL-011-00068	RDTL-031-00068	RDRY-701-00265	7
1.0610 - 1.1024	26.95 - 28.00	2	<b>RDKL-220-02695</b>	<b>RDKL-120-02695</b>	RDCL-011-00068	RDTL-031-00068	RDRY-701-00265	7
1.0610 - 1.1024	26.95 - 28.00	3	<b>RDKL-230-02695</b>	<b>RDKL-130-02695</b>	RDCL-011-00068	RDTL-031-00068	RDRY-701-00265	7
1.0917 - 1.1327	27.73 - 28.77	1	<b>RDKL-210-02773</b>	<b>RDKL-110-02773</b>	RDCL-011-00070	RDTL-031-00070	RDRY-701-00265	7
1.0917 - 1.1327	27.73 - 28.77	2	<b>RDKL-220-02773</b>	<b>RDKL-120-02773</b>	RDCL-011-00070	RDTL-031-00070	RDRY-701-00265	7
1.0917 - 1.1327	27.73 - 28.77	3	<b>RDKL-230-02773</b>	<b>RDKL-130-02773</b>	RDCL-011-00070	RDTL-031-00070	RDRY-701-00265	7
1.1240 - 1.1650	28.55 - 29.59	1	<b>RDKL-210-02855</b>	<b>RDKL-110-02855</b>	RDCL-011-00072	RDTL-031-00066	RDRY-701-00312	7
1.1240 - 1.1650	28.55 - 29.59	2	<b>RDKL-220-02855</b>	<b>RDKL-120-02855</b>	RDCL-011-00072	RDTL-031-00066	RDRY-701-00312	7
1.1240 - 1.1650	28.55 - 29.59	3	<b>RDKL-230-02855</b>	<b>RDKL-130-02855</b>	RDCL-011-00072	RDTL-031-00066	RDRY-701-00312	7
1.1551 - 1.1965	29.34 - 30.39	1	<b>RDKL-210-02934</b>	<b>RDKL-110-02934</b>	RDCL-011-00074	RDTL-031-00068	RDRY-701-00312	7
1.1551 - 1.1965	29.34 - 30.39	2	<b>RDKL-220-02934</b>	<b>RDKL-120-02934</b>	RDCL-011-00074	RDTL-031-00068	RDRY-701-00312	7
1.1551 - 1.1965	29.34 - 30.39	3	<b>RDKL-230-02934</b>	<b>RDKL-130-02934</b>	RDCL-011-00074	RDTL-031-00068	RDRY-701-00312	7
1.1858 - 1.2268	30.12 - 31.16	1	<b>RDKL-210-03012</b>	<b>RDKL-110-03012</b>	RDCL-011-00076	RDTL-031-00070	RDRY-701-00312	7
1.1858 - 1.2268	30.12 - 31.16	2	<b>RDKL-220-03012</b>	<b>RDKL-120-03012</b>	RDCL-011-00076	RDTL-031-00070	RDRY-701-00312	7
1.1858 - 1.2268	30.12 - 31.16	3	<b>RDKL-230-03012</b>	<b>RDKL-130-03012</b>	RDCL-011-00076	RDTL-031-00070	RDRY-701-00312	7

**NOTE:** Each roller burnishing tool comes assembled complete with cage, cone, and rolls.

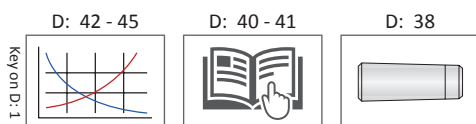



## Roller Burnishing Tools | Blind Holes

L Series | Diameter Range: 0.9661" - 1.2268" (24.54mm - 31.16mm)

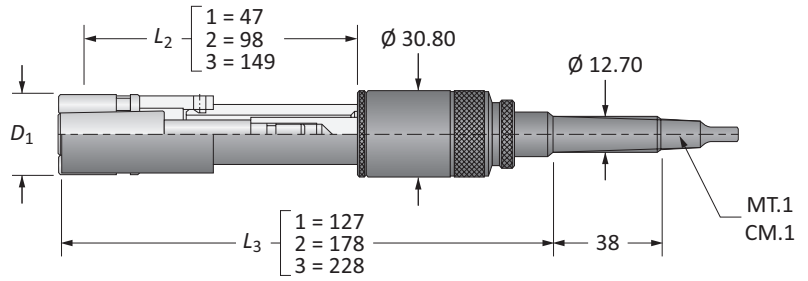

D <sub>1</sub>		L	Part No.*		Spare Parts			Qty Rolls
Imperial (in)	Metric (mm)		Assembly with Morse Taper Shank	Assembly with Straight Shank	Cage	Cone**	Rolls	
0.9661 - 1.0075	24.54 - 25.59	1	RSKL-210-xxxxx	RSKL-110-xxxxx	RSCL-015-00062	RSTL-03x-00062	RSRY-708-00265	5
0.9661 - 1.0075	24.54 - 25.59	2	RSKL-220-xxxxx	RSKL-120-xxxxx	RSCL-015-00062	RSTL-03x-00062	RSRY-708-00265	5
0.9661 - 1.0075	24.54 - 25.59	3	RSKL-230-xxxxx	RSKL-130-xxxxx	RSCL-015-00062	RSTL-03x-00062	RSRY-708-00265	5
0.9992 - 1.0402	25.38 - 26.42	1	RSKL-210-xxxxx	RSKL-110-xxxxx	RSCL-015-00064	RSTL-03x-00064	RSRY-708-00265	5
0.9992 - 1.0402	25.38 - 26.42	2	RSKL-220-xxxxx	RSKL-120-xxxxx	RSCL-015-00064	RSTL-03x-00064	RSRY-708-00265	5
0.9992 - 1.0402	25.38 - 26.42	3	RSKL-230-xxxxx	RSKL-130-xxxxx	RSCL-015-00064	RSTL-03x-00064	RSRY-708-00265	5
1.0299 - 1.0709	26.16 - 27.20	1	RSKL-210-xxxxx	RSKL-110-xxxxx	RSCL-015-00066	RSTL-03x-00066	RSRY-708-00265	5
1.0299 - 1.0709	26.16 - 27.20	2	RSKL-220-xxxxx	RSKL-120-xxxxx	RSCL-015-00066	RSTL-03x-00066	RSRY-708-00265	5
1.0299 - 1.0709	26.16 - 27.20	3	RSKL-230-xxxxx	RSKL-130-xxxxx	RSCL-015-00066	RSTL-03x-00066	RSRY-708-00265	5
1.0610 - 1.1024	26.95 - 28.00	1	RSKL-210-xxxxx	RSKL-110-xxxxx	RSCL-015-00068	RSTL-03x-00068	RSRY-708-00265	5
1.0610 - 1.1024	26.95 - 28.00	2	RSKL-220-xxxxx	RSKL-120-xxxxx	RSCL-015-00068	RSTL-03x-00068	RSRY-708-00265	5
1.0610 - 1.1024	26.95 - 28.00	3	RSKL-230-xxxxx	RSKL-130-xxxxx	RSCL-015-00068	RSTL-03x-00068	RSRY-708-00265	5
1.0917 - 1.1327	27.73 - 28.77	1	RSKL-210-xxxxx	RSKL-110-xxxxx	RSCL-015-00070	RSTL-03x-00070	RSRY-708-00265	5
1.0917 - 1.1327	27.73 - 28.77	2	RSKL-220-xxxxx	RSKL-120-xxxxx	RSCL-015-00070	RSTL-03x-00070	RSRY-708-00265	5
1.0917 - 1.1327	27.73 - 28.77	3	RSKL-230-xxxxx	RSKL-130-xxxxx	RSCL-015-00070	RSTL-03x-00070	RSRY-708-00265	5
1.1240 - 1.1650	28.55 - 29.59	1	RSKL-210-xxxxx	RSKL-110-xxxxx	RSCL-015-00072	RSTL-03x-00066	RSRY-708-00312	5
1.1240 - 1.1650	28.55 - 29.59	2	RSKL-220-xxxxx	RSKL-120-xxxxx	RSCL-015-00072	RSTL-03x-00066	RSRY-708-00312	5
1.1240 - 1.1650	28.55 - 29.59	3	RSKL-230-xxxxx	RSKL-130-xxxxx	RSCL-015-00072	RSTL-03x-00066	RSRY-708-00312	5
1.1551 - 1.1965	29.34 - 30.39	1	RSKL-210-xxxxx	RSKL-110-xxxxx	RSCL-015-00074	RSTL-03x-00068	RSRY-708-00312	5
1.1551 - 1.1965	29.34 - 30.39	2	RSKL-220-xxxxx	RSKL-120-xxxxx	RSCL-015-00074	RSTL-03x-00068	RSRY-708-00312	5
1.1551 - 1.1965	29.34 - 30.39	3	RSKL-230-xxxxx	RSKL-130-xxxxx	RSCL-015-00074	RSTL-03x-00068	RSRY-708-00312	5
1.1858 - 1.2268	30.12 - 31.16	1	RSKL-210-xxxxx	RSKL-110-xxxxx	RSCL-015-00076	RSTL-03x-00070	RSRY-708-00312	5
1.1858 - 1.2268	30.12 - 31.16	2	RSKL-220-xxxxx	RSKL-120-xxxxx	RSCL-015-00076	RSTL-03x-00070	RSRY-708-00312	5
1.1858 - 1.2268	30.12 - 31.16	3	RSKL-230-xxxxx	RSKL-130-xxxxx	RSCL-015-00076	RSTL-03x-00070	RSRY-708-00312	5

\*xxxxx = Indicate to 2 metric decimal places the size to be burnished (e.g. short series roller burnisher Ø 27.50mm with MT.1 shank: RSKL-210-02750).

\*\*x = A number that will vary from 2 to 8 depending upon the exact diameter to be burnished. See page D: 6 for the correct identification of the "x" value.

**NOTE:** Each roller burnishing tool comes assembled complete with cage, cone, and rolls.

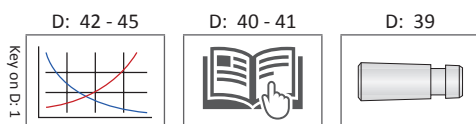

L  
A  
DRILLING  
B  
BORING  
C  
REAMING  
D  
BURNISHING  
E  
THREADING  
X  
SPECIALS

## Roller Burnishing Tools | Through Holes

F Series | Diameter Range: 0.9661" - 1.2268" (24.54mm - 31.16mm)

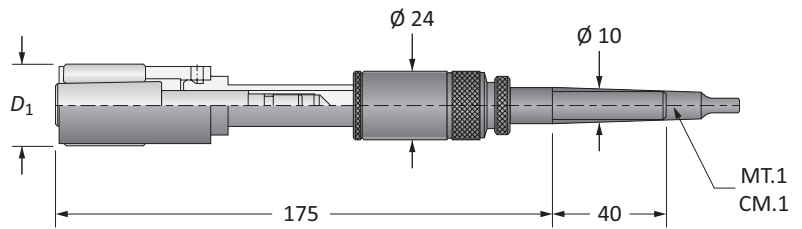

$D_1$		Part No.		Spare Parts			
Imperial (in)	Metric (mm)	Assembly with Morse Taper Shank	Assembly with Straight Shank	Cage	Cone	Rolls	Qty Rolls
0.9661 - 1.0075	24.54 - 25.59	<b>RDKF-200-02454</b>	<b>RDKF-100-02454</b>	RDCL-011-00062	RDTF-031-00062	RDRY-701-00265	5
0.9992 - 1.0402	25.38 - 26.42	<b>RDKF-200-02538</b>	<b>RDKF-100-02538</b>	RDCL-011-00064	RDTF-031-00064	RDRY-701-00265	7
1.0299 - 1.0709	26.16 - 27.20	<b>RDKF-200-02616</b>	<b>RDKF-100-02616</b>	RDCL-011-00066	RDTF-031-00066	RDRY-701-00265	7
1.0610 - 1.1024	26.95 - 28.00	<b>RDKF-200-02695</b>	<b>RDKF-100-02695</b>	RDCL-011-00068	RDTF-031-00068	RDRY-701-00265	7
1.0917 - 1.1327	27.73 - 28.77	<b>RDKF-200-02773</b>	<b>RDKF-100-02773</b>	RDCL-011-00070	RDTF-031-00070	RDRY-701-00265	7
1.1240 - 1.1650	28.55 - 29.59	<b>RDKF-200-02855</b>	<b>RDKF-100-02855</b>	RDCL-011-00072	RDTF-031-00066	RDRY-701-00312	7
1.1551 - 1.1965	29.34 - 30.39	<b>RDKF-200-02934</b>	<b>RDKF-100-02934</b>	RDCL-011-00074	RDTF-031-00068	RDRY-701-00312	7
1.1858 - 1.2268	30.12 - 31.16	<b>RDKF-200-03012</b>	<b>RDKF-100-03012</b>	RDCL-011-00076	RDTF-031-00070	RDRY-701-00312	7

**NOTE:** Each roller burnishing tool comes assembled complete with cage, cone, and rolls.

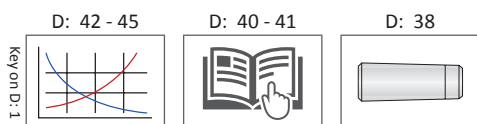



## Roller Burnishing Tools | Blind Holes

F Series | Diameter Range: 0.9661" - 1.2268" (24.54mm - 31.16mm)

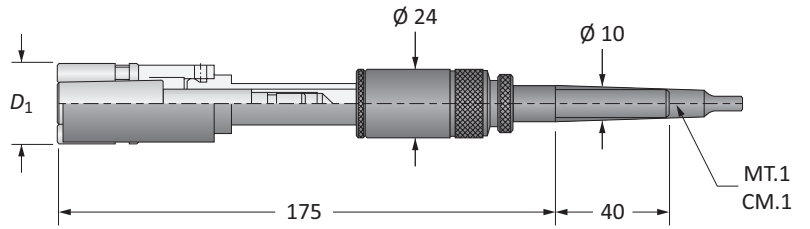

D <sub>1</sub>		Part No.*		Spare Parts			Qty Rolls
Imperial (in)	Metric (mm)	Assembly with Morse Taper Shank	Assembly with Straight Shank	Cage	Cone**	Rolls	
0.9661 - 1.0075	24.54 - 25.59	RSKF-200-xxxxx	RSKF-100-xxxxx	RSCL-015-00062	RSTF-03x-00062	RSRY-708-00265	5
0.9992 - 1.0402	25.38 - 26.42	RSKF-200-xxxxx	RSKF-100-xxxxx	RSCL-015-00064	RSTF-03x-00064	RSRY-708-00265	5
1.0299 - 1.0709	26.16 - 27.20	RSKF-200-xxxxx	RSKF-100-xxxxx	RSCL-015-00066	RSTF-03x-00066	RSRY-708-00265	5
1.0610 - 1.1024	26.95 - 28.00	RSKF-200-xxxxx	RSKF-100-xxxxx	RSCL-015-00068	RSTF-03x-00068	RSRY-708-00265	5
1.0917 - 1.1327	27.73 - 28.77	RSKF-200-xxxxx	RSKF-100-xxxxx	RSCL-015-00070	RSTF-03x-00070	RSRY-708-00265	5
1.1240 - 1.1650	28.55 - 29.59	RSKF-200-xxxxx	RSKF-100-xxxxx	RSCL-015-00072	RSTF-03x-00066	RSRY-708-00312	5
1.1551 - 1.1965	29.34 - 30.39	RSKF-200-xxxxx	RSKF-100-xxxxx	RSCL-015-00074	RSTF-03x-00068	RSRY-708-00312	5
1.1858 - 1.2268	30.12 - 31.16	RSKF-200-xxxxx	RSKF-100-xxxxx	RSCL-015-00076	RSTF-03x-00070	RSRY-708-00312	5

\*xxxxx = Indicate to 2 metric decimal places the size to be burnished (e.g. roller burnisher Ø 27.00mm with MT.1 shank: RSKF-200-02700).

\*\*x = A number that will vary from 2 to 8 depending upon the exact diameter to be burnished. See page D: 6 for the correct identification of the "x" value.

**NOTE:** Each roller burnishing tool comes assembled complete with cage, cone, and rolls.

D: 42 - 45      D: 40 - 41      D: 39

## Roller Burnishing Tools | Through Holes

M Series | Diameter Range: 1.2146" - 1.4118" (30.85mm - 35.86mm)

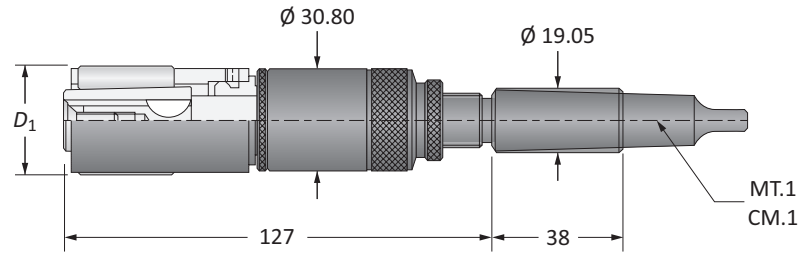

$D_1$		Part No.		Spare Parts			
Imperial (in)	Metric (mm)	Assembly with Morse Taper Shank	Assembly with Straight Shank	Cage	Cone	Rolls	Qty Rolls
1.2146 - 1.2559	30.85 - 31.90	<b>RDKM-200-03085</b>	<b>RDKM-100-03085</b>	RDCM-011-00078	RDTM-031-00078	RDRY-701-00265	7
1.2469 - 1.2878	31.67 - 32.71	<b>RDKM-200-03167</b>	<b>RDKM-100-03167</b>	RDCM-011-00080	RDTM-031-00080	RDRY-701-00265	7
1.2772 - 1.3177	32.44 - 33.47	<b>RDKM-200-03244</b>	<b>RDKM-100-03244</b>	RDCM-011-00082	RDTM-031-00082	RDRY-701-00265	7
1.3087 - 1.3500	33.24 - 34.29	<b>RDKM-200-03324</b>	<b>RDKM-100-03324</b>	RDCM-011-00084	RDTM-031-00078	RDRY-701-00312	7
1.3406 - 1.3815	34.05 - 35.09	<b>RDKM-200-03405</b>	<b>RDKM-100-03405</b>	RDCM-011-00086	RDTM-031-00080	RDRY-701-00312	7
1.3713 - 1.4118	34.83 - 35.86	<b>RDKM-200-03483</b>	<b>RDKM-100-03483</b>	RDCM-011-00088	RDTM-031-00082	RDRY-701-00312	7

**NOTE:** Each roller burnishing tool comes assembled complete with cage, cone, and rolls.

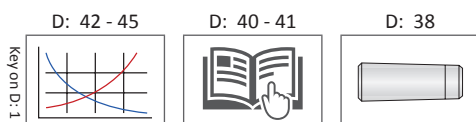



## Roller Burnishing Tools | Blind Holes

M Series | Diameter Range: 1.2146" - 1.4118" (30.85mm - 35.86mm)

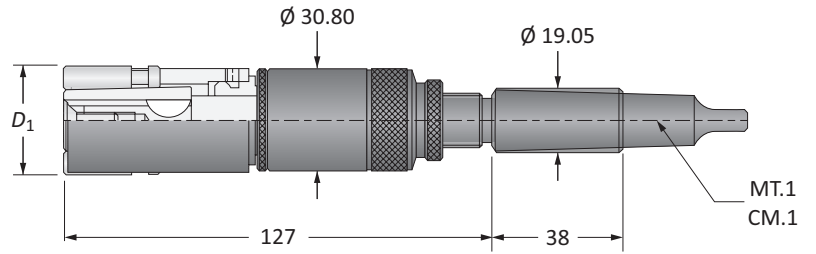

D <sub>1</sub>		Part No.*		Spare Parts			Qty Rolls
Imperial (in)	Metric (mm)	Assembly with Morse Taper Shank	Assembly with Straight Shank	Cage	Cone**	Rolls	
1.2146 - 1.2559	30.85 - 31.90	RSKM-200-xxxxx	RSKM-100-xxxxx	RSCM-015-00078	RSTM-03x-00078	RSRY-708-00265	5
1.2469 - 1.2878	31.67 - 32.71	RSKM-200-xxxxx	RSKM-100-xxxxx	RSCM-015-00080	RSTM-03x-00080	RSRY-708-00265	5
1.2772 - 1.3177	32.44 - 33.47	RSKM-200-xxxxx	RSKM-100-xxxxx	RSCM-015-00082	RSTM-03x-00082	RSRY-708-00265	5
1.3087 - 1.3500	33.24 - 34.29	RSKM-200-xxxxx	RSKM-100-xxxxx	RSCM-015-00084	RSTM-03x-00078	RSRY-708-00312	5
1.3406 - 1.3815	34.05 - 35.09	RSKM-200-xxxxx	RSKM-100-xxxxx	RSCM-015-00086	RSTM-03x-00080	RSRY-708-00312	5
1.3713 - 1.4118	34.83 - 35.86	RSKM-200-xxxxx	RSKM-100-xxxxx	RSCM-015-00088	RSTM-03x-00082	RSRY-708-00312	5

\*xxxxx = Indicate to 2 metric decimal places the size to be burnished (e.g. roller burnisher Ø 35.00mm with MT.2 shank: RSKM-200-03500).

\*\*x = A number that will vary from 2 to 8 depending upon the exact diameter to be burnished. See page D: 6 for the correct identification of the "x" value.

**NOTE:** Each roller burnishing tool comes assembled complete with cage, cone, and rolls.

D: 42 - 45

D: 40 - 41

D: 39

Key on D: 1

## Roller Burnishing Tools | Through Holes

N Series | Diameter Range: 1.4020" - 1.8492" (35.61mm - 46.97mm)

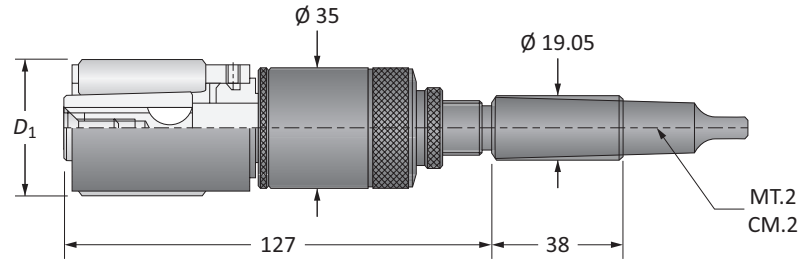

$D_1$		Part No.		Spare Parts			
Imperial (in)	Metric (mm)	Assembly with Morse Taper Shank	Assembly with Straight Shank	Cage	Cone	Rolls	Qty Rolls
1.4020 - 1.4433	35.61 - 36.66	RDKN-200-03561	RDKN-100-03561	RDCN-011-00090	RDTN-031-00090	RDRY-701-00312	7
1.4331 - 1.4740	36.40 - 37.44	RDKN-200-03640	RDKN-100-03640	RDCN-011-00092	RDTN-031-00092	RDRY-701-00312	7
1.4638 - 1.5051	37.18 - 38.23	RDKN-200-03718	RDKN-100-03718	RDCN-011-00094	RDTN-031-00094	RDRY-701-00312	7
1.4961 - 1.5370	38.00 - 39.04	RDKN-200-03800	RDKN-100-03800	RDCN-011-00096	RDTN-031-00096	RDRY-701-00312	7
1.5272 - 1.5677	38.79 - 39.82	RDKN-200-03879	RDKN-100-03879	RDCN-011-00098	RDTM-031-00080	RDRY-701-00406	7
1.5579 - 1.5992	39.57 - 40.62	RDKN-200-03957	RDKN-100-03957	RDCN-011-00100	RDTM-031-00082	RDRY-701-00406	7
1.5890 - 1.6299	40.36 - 41.40	RDKN-200-04036	RDKN-100-04036	RDCN-011-00102	RDTN-031-00090	RDRY-701-00406	7
1.6213 - 1.6618	41.18 - 42.21	RDKN-200-04118	RDKN-100-04118	RDCN-011-00104	RDTN-031-00092	RDRY-701-00406	7
1.6520 - 1.6933	41.96 - 43.01	RDKN-200-04196	RDKN-100-04196	RDCN-011-00106	RDTN-031-00094	RDRY-701-00406	7
1.6831 - 1.7240	42.75 - 43.79	RDKN-200-04275	RDKN-100-04275	RDCN-011-00108	RDTM-031-00082	RDRY-701-00468	7
1.7138 - 1.7551	43.53 - 44.58	RDKN-200-04353	RDKN-100-04353	RDCN-011-00110	RDTN-031-00090	RDRY-701-00468	7
1.7461 - 1.7870	44.35 - 45.39	RDKN-200-04435	RDKN-100-04435	RDCN-011-00112	RDTN-031-00092	RDRY-701-00468	7
1.7772 - 1.8177	45.14 - 46.17	RDKN-200-04514	RDKN-100-04514	RDCN-011-00114	RDTN-031-00094	RDRY-701-00468	7
1.8079 - 1.8492	45.92 - 46.97	RDKN-200-04592	RDKN-100-04592	RDCN-011-00116	RDTN-031-00096	RDRY-701-00468	7

**NOTE:** Each roller burnishing tool comes assembled complete with cage, cone, and rolls.

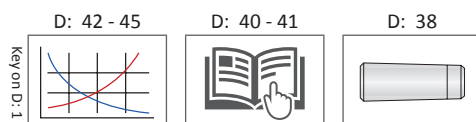





## Roller Burnishing Tools | Blind Holes

N Series | Diameter Range: 1.4020" - 1.8492" (35.61mm - 46.97mm)

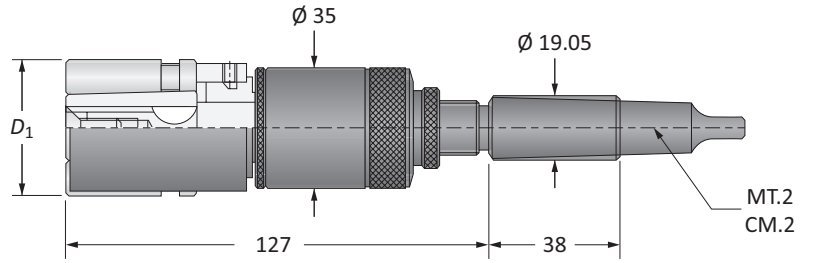

$D_1$		Part No.*		Spare Parts			Qty Rolls
Imperial (in)	Metric (mm)	Assembly with Morse Taper Shank	Assembly with Straight Shank	Cage	Cone**	Rolls	
1.4020 - 1.4433	35.61 - 36.66	RSKN-200-xxxxx	RSKN-100-xxxxx	RSCN-015-00090	RSTN-03x-00090	RSRY-708-00312	5
1.4331 - 1.4740	36.40 - 37.44	RSKN-200-xxxxx	RSKN-100-xxxxx	RSCN-015-00092	RSTN-03x-00092	RSRY-708-00312	5
1.4638 - 1.5051	37.18 - 38.23	RSKN-200-xxxxx	RSKN-100-xxxxx	RSCN-015-00094	RSTN-03x-00094	RSRY-708-00312	5
1.4961 - 1.5370	38.00 - 39.04	RSKN-200-xxxxx	RSKN-100-xxxxx	RSCN-015-00096	RSTN-03x-00096	RSRY-708-00312	5
1.5272 - 1.5677	38.79 - 39.82	RSKN-200-xxxxx	RSKN-100-xxxxx	RSCN-015-00098	RSTM-03x-00080	RSRY-708-00406	5
1.5579 - 1.5992	39.57 - 40.62	RSKN-200-xxxxx	RSKN-100-xxxxx	RSCN-015-00100	RSTM-03x-00082	RSRY-708-00406	5
1.5890 - 1.6299	40.36 - 41.40	RSKN-200-xxxxx	RSKN-100-xxxxx	RSCN-015-00102	RSTN-03x-00090	RSRY-708-00406	5
1.6213 - 1.6618	41.18 - 42.21	RSKN-200-xxxxx	RSKN-100-xxxxx	RSCN-015-00104	RSTN-03x-00092	RSRY-708-00406	5
1.6520 - 1.6933	41.96 - 43.01	RSKN-200-xxxxx	RSKN-100-xxxxx	RSCN-015-00106	RSTN-03x-00094	RSRY-708-00406	5
1.6831 - 1.7240	42.75 - 43.79	RSKN-200-xxxxx	RSKN-100-xxxxx	RSCN-015-00108	RSTM-03x-00082	RSRY-708-00468	5
1.7138 - 1.7551	43.53 - 44.58	RSKN-200-xxxxx	RSKN-100-xxxxx	RSCN-015-00110	RSTN-03x-00090	RSRY-708-00468	5
1.7461 - 1.7870	44.35 - 45.39	RSKN-200-xxxxx	RSKN-100-xxxxx	RSCN-015-00112	RSTN-03x-00092	RSRY-708-00468	5
1.7772 - 1.8177	45.14 - 46.17	RSKN-200-xxxxx	RSKN-100-xxxxx	RSCN-015-00114	RSTN-03x-00094	RSRY-708-00468	5
1.8079 - 1.8492	45.92 - 46.97	RSKN-200-xxxxx	RSKN-100-xxxxx	RSCN-015-00116	RSTN-03x-00096	RSRY-708-00468	5

\*xxxxx = Indicate to 2 metric decimal places the size to be burnished (e.g. roller burnisher Ø 40.00mm with straight shank: RSKN-100-04000).

\*\*x = A number that will vary from 2 to 8 depending upon the exact diameter to be burnished. See page D: 6 for the correct identification of the "x" value.

**NOTE:** Each roller burnishing tool comes assembled complete with cage, cone, and rolls.

D: 42 - 45

D: 40 - 41

D: 39

Key on D: 1

## Roller Burnishing Tools | Through Holes

O Series | Diameter Range: 1.8390" - 2.2240" (46.71mm - 56.49mm)

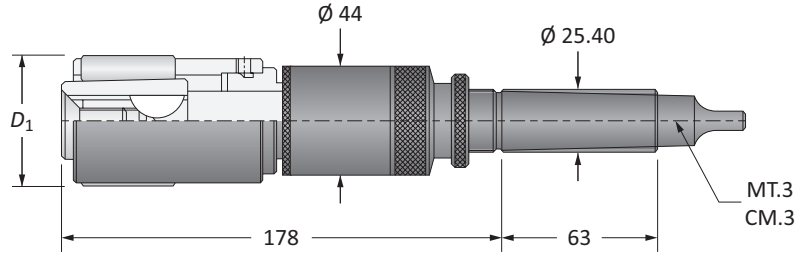

### Through Holes

D <sub>1</sub>		Part No.		Spare Parts			
Imperial (in)	Metric (mm)	Assembly with Morse Taper Shank	Assembly with Straight Shank	Cage	Cone	Rolls	Qty Rolls
1.8390 - 1.8799	46.71 - 47.75	<b>RDKO-200-04671</b>	<b>RDKO-100-04671</b>	RDCO-011-00118	RDTO-031-00118	RDRY-701-00312	9
1.8713 - 1.9118	47.53 - 48.56	<b>RDKO-200-04753</b>	<b>RDKO-100-04753</b>	RDCO-011-00120	RDTO-031-00120	RDRY-701-00312	9
1.9020 - 1.9433	48.31 - 49.36	<b>RDKO-200-04831</b>	<b>RDKO-100-04831</b>	RDCO-011-00122	RDTO-031-00122	RDRY-701-00312	9
1.9331 - 1.9740	49.10 - 50.14	<b>RDKO-200-04910</b>	<b>RDKO-100-04910</b>	RDCO-011-00124	RDTO-031-00124	RDRY-701-00312	9
1.9638 - 2.0051	49.88 - 50.93	<b>RDKO-200-04988</b>	<b>RDKO-100-04988</b>	RDCO-011-00126	RDTO-031-00126	RDRY-701-00312	9
1.9961 - 2.0370	50.70 - 51.74	<b>RDKO-200-05070</b>	<b>RDKO-100-05070</b>	RDCO-011-00128	RDTO-031-00128	RDRY-701-00312	9
2.0272 - 2.0681	51.49 - 52.53	<b>RDKO-200-05149</b>	<b>RDKO-100-05149</b>	RDCO-011-00130	RDTO-031-00118	RDRY-701-00406	9
2.0579 - 2.0992	52.27 - 53.32	<b>RDKO-200-05227</b>	<b>RDKO-100-05227</b>	RDCO-011-00132	RDTO-031-00120	RDRY-701-00406	9
2.0890 - 2.1299	53.06 - 54.10	<b>RDKO-200-05306</b>	<b>RDKO-100-05306</b>	RDCO-011-00134	RDTO-031-00122	RDRY-701-00406	9
2.1209 - 2.1618	53.87 - 54.91	<b>RDKO-200-05387</b>	<b>RDKO-100-05387</b>	RDCO-011-00136	RDTO-031-00124	RDRY-701-00406	9
2.1520 - 2.1933	54.66 - 55.71	<b>RDKO-200-05466</b>	<b>RDKO-100-05466</b>	RDCO-011-00138	RDTO-031-00126	RDRY-701-00406	9
2.1831 - 2.2240	55.45 - 56.49	<b>RDKO-200-05545</b>	<b>RDKO-100-05545</b>	RDCO-011-00140	RDTO-031-00128	RDRY-701-00406	9

**NOTE:** Each roller burnishing tool comes assembled complete with cage, cone, and rolls.

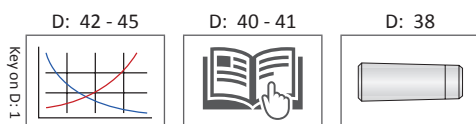



## Roller Burnishing Tools | Blind Holes

O Series | Diameter Range: 1.8390" - 2.2240" (46.71mm - 56.49mm)

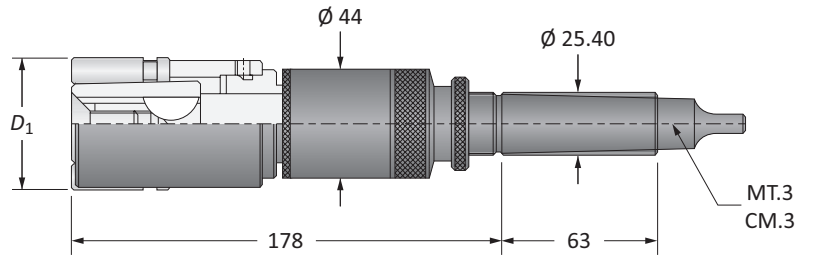

### Blind Holes

$D_1$		Part No.*		Spare Parts			Qty Rolls
Imperial (in)	Metric (mm)	Assembly with Morse Taper Shank	Assembly with Straight Shank	Cage	Cone**	Rolls	
1.8390 - 1.8799	46.71 - 47.75	RSKO-200-xxxxx	RSKO-100-xxxxx	RSCO-015-00118	RSTO-03x-00118	RSRY-708-00312	7
1.8713 - 1.9118	47.53 - 48.56	RSKO-200-xxxxx	RSKO-100-xxxxx	RSCO-015-00120	RSTO-03x-00120	RSRY-708-00312	7
1.9020 - 1.9433	48.31 - 49.36	RSKO-200-xxxxx	RSKO-100-xxxxx	RSCO-015-00122	RSTO-03x-00122	RSRY-708-00312	7
1.9331 - 1.9740	49.10 - 50.14	RSKO-200-xxxxx	RSKO-100-xxxxx	RSCO-015-00124	RSTO-03x-00124	RSRY-708-00312	7
1.9638 - 2.0051	49.88 - 50.93	RSKO-200-xxxxx	RSKO-100-xxxxx	RSCO-015-00126	RSTO-03x-00126	RSRY-708-00312	7
1.9961 - 2.0370	50.70 - 51.74	RSKO-200-xxxxx	RSKO-100-xxxxx	RSCO-015-00128	RSTO-03x-00128	RSRY-708-00312	7
2.0272 - 2.0681	51.49 - 52.53	RSKO-200-xxxxx	RSKO-100-xxxxx	RSCO-015-00130	RSTO-03x-00118	RSRY-708-00406	7
2.0579 - 2.0992	52.27 - 53.32	RSKO-200-xxxxx	RSKO-100-xxxxx	RSCO-015-00132	RSTO-03x-00120	RSRY-708-00406	7
2.0890 - 2.1299	53.06 - 54.10	RSKO-200-xxxxx	RSKO-100-xxxxx	RSCO-015-00134	RSTO-03x-00122	RSRY-708-00406	7
2.1209 - 2.1618	53.87 - 54.91	RSKO-200-xxxxx	RSKO-100-xxxxx	RSCO-015-00136	RSTO-03x-00124	RSRY-708-00406	7
2.1520 - 2.1933	54.66 - 55.71	RSKO-200-xxxxx	RSKO-100-xxxxx	RSCO-015-00138	RSTO-03x-00126	RSRY-708-00406	7
2.1831 - 2.2240	55.45 - 56.49	RSKO-200-xxxxx	RSKO-100-xxxxx	RSCO-015-00140	RSTO-03x-00128	RSRY-708-00406	7

\*xxxxx = Indicate to 2 metric decimal places the size to be burnished (e.g. roller burnisher Ø 50.25mm with MT.3 shank: RSKO-200-05025).

\*\*x = A number that will vary from 2 to 8 depending upon the exact diameter to be burnished. See page D: 6 for the correct identification of the "x" value.

**NOTE:** Each roller burnishing tool comes assembled complete with cage, cone, and rolls.

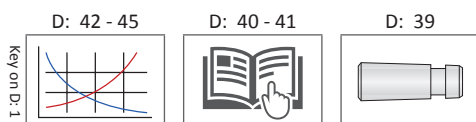

## Roller Burnishing Tools | Through Holes

P Series | Diameter Range: 2.2138" - 2.7240" (56.23mm - 69.19mm)

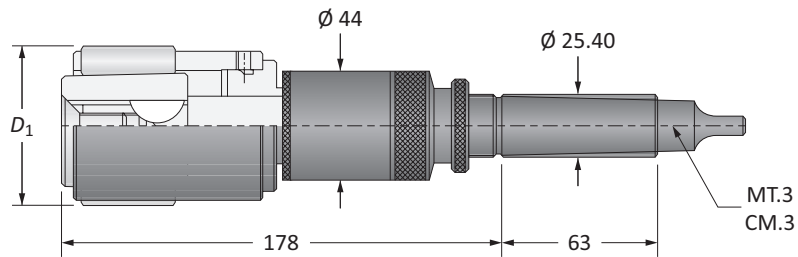

### Through Holes

$D_1$		Part No.		Spare Parts			
Imperial (in)	Metric (mm)	Assembly with Morse Taper Shank	Assembly with Straight Shank	Cage	Cone	Rolls	Qty Rolls
2.2138 - 2.2551	56.23 - 57.28	RDKP-200-05623	RDKP-100-05623	RDCP-011-00142	RDTP-031-00142	RDRY-701-00406	9
2.2461 - 2.2870	57.05 - 58.09	RDKP-200-05705	RDKP-100-05705	RDCP-011-00144	RDTP-031-00144	RDRY-701-00406	9
2.2772 - 2.3177	57.84 - 58.87	RDKP-200-05784	RDKP-100-05784	RDCP-011-00146	RDTP-031-00146	RDRY-701-00406	9
2.3079 - 2.3492	58.62 - 59.67	RDKP-200-05862	RDKP-100-05862	RDCP-011-00148	RDTP-031-00148	RDRY-701-00406	9
2.3390 - 2.3799	59.41 - 60.45	RDKP-200-05941	RDKP-100-05941	RDCP-011-00150	RDTP-031-00142	RDRY-701-00468	9
2.3713 - 2.4118	60.23 - 61.26	RDKP-200-06023	RDKP-100-06023	RDCP-011-00152	RDTP-031-00144	RDRY-701-00468	9
2.4020 - 2.4433	61.01 - 62.06	RDKP-200-06101	RDKP-100-06101	RDCP-011-00154	RDTP-031-00146	RDRY-701-00468	9
2.4330 - 2.4740	61.80 - 62.84	RDKP-200-06180	RDKP-100-06180	RDCP-011-00156	RDTP-031-00148	RDRY-701-00468	9
2.4638 - 2.5051	62.58 - 63.63	RDKP-200-06258	RDKP-100-06258	RDCP-011-00158	RDTP-031-00158	RDRY-701-00468	9
2.4961 - 2.5370	63.40 - 64.44	RDKP-200-06340	RDKP-100-06340	RDCP-011-00160	RDTP-031-00160	RDRY-701-00468	9
2.5272 - 2.5677	64.19 - 65.22	RDKP-200-06419	RDKP-100-06419	RDCP-011-00162	RDTP-031-00162	RDRY-701-00468	9
2.5579 - 2.5992	64.97 - 66.02	RDKP-200-06497	RDKP-100-06497	RDCP-011-00164	RDTP-031-00164	RDRY-701-00468	9
2.5890 - 2.6299	65.76 - 66.80	RDKP-200-06576	RDKP-100-06576	RDCP-011-00166	RDTP-031-00158	RDRY-701-00531	9
2.6213 - 2.6618	66.58 - 67.61	RDKP-200-06658	RDKP-100-06658	RDCP-011-00168	RDTP-031-00160	RDRY-701-00531	9
2.6520 - 2.6933	67.36 - 68.41	RDKP-200-06736	RDKP-100-06736	RDCP-011-00170	RDTP-031-00162	RDRY-701-00531	9
2.6830 - 2.7240	68.15 - 69.19	RDKP-200-06815	RDKP-100-06815	RDCP-011-00172	RDTP-031-00164	RDRY-701-00531	9

**NOTE:** Each roller burnishing tool comes assembled complete with cage, cone, and rolls.

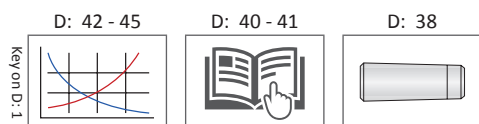



## Roller Burnishing Tools | Blind Holes

P Series | Diameter Range: 2.2138" - 2.7240" (56.23mm - 69.19mm)

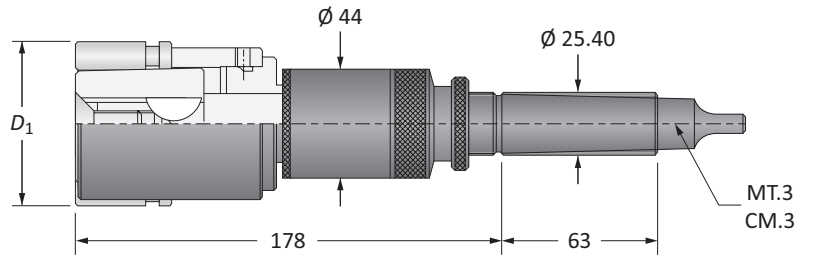

### Blind Holes

D <sub>1</sub>		Part No.*		Spare Parts			Qty Rolls
Imperial (in)	Metric (mm)	Assembly with Morse Taper Shank	Assembly with Straight Shank	Cage	Cone**	Rolls	
2.2138 - 2.2551	56.23 - 57.28	RSKP-200-xxxxx	RSKP-100-xxxxx	RSCP-015-00142	RSTP-03x-00142	RSRY-708-00406	7
2.2461 - 2.2870	57.05 - 58.09	RSKP-200-xxxxx	RSKP-100-xxxxx	RSCP-015-00144	RSTP-03x-00144	RSRY-708-00406	7
2.2772 - 2.3177	57.84 - 58.87	RSKP-200-xxxxx	RSKP-100-xxxxx	RSCP-015-00146	RSTP-03x-00146	RSRY-708-00406	7
2.3079 - 2.3492	58.62 - 59.67	RSKP-200-xxxxx	RSKP-100-xxxxx	RSCP-015-00148	RSTP-03x-00148	RSRY-708-00406	7
2.3390 - 2.3799	59.41 - 60.45	RSKP-200-xxxxx	RSKP-100-xxxxx	RSCP-015-00150	RSTP-03x-00142	RSRY-708-00468	7
2.3713 - 2.4118	60.23 - 61.26	RSKP-200-xxxxx	RSKP-100-xxxxx	RSCP-015-00152	RSTP-03x-00144	RSRY-708-00468	7
2.4020 - 2.4433	61.01 - 62.06	RSKP-200-xxxxx	RSKP-100-xxxxx	RSCP-015-00154	RSTP-03x-00146	RSRY-708-00468	7
2.4330 - 2.4740	61.80 - 62.84	RSKP-200-xxxxx	RSKP-100-xxxxx	RSCP-015-00156	RSTP-03x-00148	RSRY-708-00468	7
2.4638 - 2.5051	62.58 - 63.63	RSKP-200-xxxxx	RSKP-100-xxxxx	RSCP-015-00158	RSTP-03x-00158	RSRY-708-00468	7
2.4961 - 2.5370	63.40 - 64.44	RSKP-200-xxxxx	RSKP-100-xxxxx	RSCP-015-00160	RSTP-03x-00160	RSRY-708-00468	7
2.5272 - 2.5677	64.19 - 65.22	RSKP-200-xxxxx	RSKP-100-xxxxx	RSCP-015-00162	RSTP-03x-00162	RSRY-708-00468	7
2.5579 - 2.5992	64.97 - 66.02	RSKP-200-xxxxx	RSKP-100-xxxxx	RSCP-015-00164	RSTP-03x-00164	RSRY-708-00468	7
2.5890 - 2.6299	65.76 - 66.80	RSKP-200-xxxxx	RSKP-100-xxxxx	RSCP-015-00166	RSTP-03x-00158	RSRY-708-00531	7
2.6213 - 2.6618	66.58 - 67.61	RSKP-200-xxxxx	RSKP-100-xxxxx	RSCP-015-00168	RSTP-03x-00160	RSRY-708-00531	7
2.6520 - 2.6933	67.36 - 68.41	RSKP-200-xxxxx	RSKP-100-xxxxx	RSCP-015-00170	RSTP-03x-00162	RSRY-708-00531	7
2.6830 - 2.7240	68.15 - 69.19	RSKP-200-xxxxx	RSKP-100-xxxxx	RSCP-015-00172	RSTP-03x-00164	RSRY-708-00531	7

\*xxxxx = Indicate to 2 metric decimal places the size to be burnished (e.g. roller burnisher Ø 60.05mm with straight shank: RSKP-100-06005).

\*\*x = A number that will vary from 2 to 8 depending upon the exact diameter to be burnished. See page D: 6 for the correct identification of the "x" value.

**NOTE:** Each roller burnishing tool comes assembled complete with cage, cone, and rolls.

Key on D: 1

D: 42 - 45

D: 40 - 41

D: 39

## Roller Burnishing Tools | Through Holes

Q Series | Diameter Range: 2.7138" - 3.3492" (68.93mm - 85.07mm)

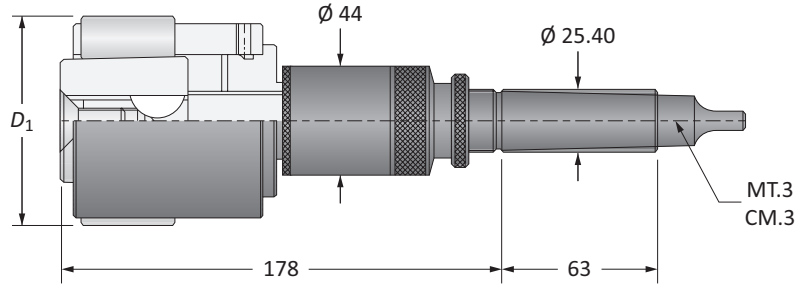

### Through Holes

D <sub>1</sub>		Part No.		Spare Parts			
Imperial (in)	Metric (mm)	Assembly with Morse Taper Shank	Assembly with Straight Shank	Cage	Cone	Rolls	Qty Rolls
2.7138 - 2.7551	68.93 - 69.98	RDKQ-200-06893	RDKQ-100-06893	RDCQ-011-00174	RDTQ-031-00174	RDRY-701-00531	9
2.7461 - 2.7870	69.75 - 70.79	RDKQ-200-06975	RDKQ-100-06975	RDCQ-011-00176	RDTQ-031-00176	RDRY-701-00531	9
2.7772 - 2.8177	70.54 - 71.57	RDKQ-200-07054	RDKQ-100-07054	RDCQ-011-00178	RDTQ-031-00178	RDRY-701-00531	9
2.8079 - 2.8504	71.32 - 72.40	RDKQ-200-07132	RDKQ-100-07132	RDCQ-011-00180	RDTQ-031-00180	RDRY-701-00531	9
2.8390 - 2.8799	72.11 - 73.15	RDKQ-200-07211	RDKQ-100-07211	RDCQ-011-00182	RDTQ-031-00182	RDRY-701-00531	9
2.8713 - 2.9118	72.93 - 73.96	RDKQ-200-07293	RDKQ-100-07293	RDCQ-011-00184	RDTQ-031-00184	RDRY-701-00531	9
2.9020 - 2.9429	73.71 - 74.75	RDKQ-200-07371	RDKQ-100-07371	RDCQ-011-00186	RDTQ-031-00174	RDRY-701-00625	9
2.9331 - 2.9740	74.50 - 75.54	RDKQ-200-07450	RDKQ-100-07450	RDCQ-011-00188	RDTQ-031-00176	RDRY-701-00625	9
2.9638 - 3.0051	75.28 - 76.33	RDKQ-200-07528	RDKQ-100-07528	RDCQ-011-00190	RDTQ-031-00178	RDRY-701-00625	9
2.9961 - 3.0370	76.10 - 77.14	RDKQ-200-07610	RDKQ-100-07610	RDCQ-011-00192	RDTQ-031-00180	RDRY-701-00625	9
3.0272 - 3.0681	76.89 - 77.93	RDKQ-200-07689	RDKQ-100-07689	RDCQ-011-00194	RDTQ-031-00182	RDRY-701-00625	9
3.0579 - 3.0992	77.67 - 78.72	RDKQ-200-07767	RDKQ-100-07767	RDCQ-011-00196	RDTQ-031-00184	RDRY-701-00625	9
3.0890 - 3.1299	78.46 - 79.50	RDKQ-200-07846	RDKQ-100-07846	RDCQ-011-00198	RDTQ-031-00198	RDRY-701-00625	9
3.1209 - 3.1618	79.27 - 80.31	RDKQ-200-07927	RDKQ-100-07927	RDCQ-011-00200	RDTQ-031-00200	RDRY-701-00625	9
3.1520 - 3.1933	80.06 - 81.11	RDKQ-200-08006	RDKQ-100-08006	RDCQ-011-00202	RDTQ-031-00202	RDRY-701-00625	9
3.1831 - 3.2240	80.85 - 81.89	RDKQ-200-08085	RDKQ-100-08085	RDCQ-011-00204	RDTQ-031-00204	RDRY-701-00625	9
3.2138 - 3.2551	81.63 - 82.68	RDKQ-200-08163	RDKQ-100-08163	RDCQ-011-00206	RDTQ-031-00198	RDRY-701-00687	9
3.2461 - 3.2870	82.45 - 83.49	RDKQ-200-08245	RDKQ-100-08245	RDCQ-011-00208	RDTQ-031-00200	RDRY-701-00687	9
3.2772 - 3.3177	83.24 - 84.27	RDKQ-200-08324	RDKQ-100-08324	RDCQ-011-00210	RDTQ-031-00202	RDRY-701-00687	9
3.3079 - 3.3492	84.02 - 85.07	RDKQ-200-08402	RDKQ-100-08402	RDCQ-011-00212	RDTQ-031-00204	RDRY-701-00687	9

**NOTE:** Each roller burnishing tool comes assembled complete with cage, cone, and rolls.

Key on D: 1

D: 42 - 45

D: 40 - 41

D: 38



## Roller Burnishing Tools | Blind Holes

Q Series | Diameter Range: 2.7138" - 3.3492" (68.93mm - 85.07mm)

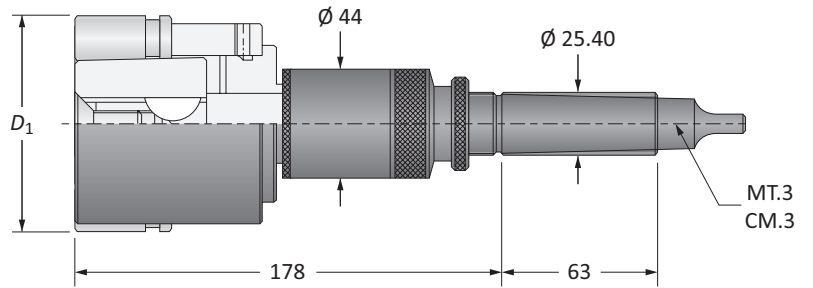

### Blind Holes

D <sub>1</sub>		Part No.*		Spare Parts			Qty Rolls
Imperial (in)	Metric (mm)	Assembly with Morse Taper Shank	Assembly with Straight Shank	Cage	Cone**	Rolls	
2.7138 - 2.7551	68.93 - 69.98	RSKQ-200-xxxxx	RSKQ-100-xxxxx	RSCQ-015-00174	RSTQ-03x-00174	RSRY-708-00531	7
2.7461 - 2.7870	69.75 - 70.79	RSKQ-200-xxxxx	RSKQ-100-xxxxx	RSCQ-015-00176	RSTQ-03x-00176	RSRY-708-00531	7
2.7772 - 2.8177	70.54 - 71.57	RSKQ-200-xxxxx	RSKQ-100-xxxxx	RSCQ-015-00178	RSTQ-03x-00178	RSRY-708-00531	7
2.8079 - 2.8504	71.32 - 72.40	RSKQ-200-xxxxx	RSKQ-100-xxxxx	RSCQ-015-00180	RSTQ-03x-00180	RSRY-708-00531	7
2.8390 - 2.8799	72.11 - 73.15	RSKQ-200-xxxxx	RSKQ-100-xxxxx	RSCQ-015-00182	RSTQ-03x-00182	RSRY-708-00531	7
2.8713 - 2.9118	72.93 - 73.96	RSKQ-200-xxxxx	RSKQ-100-xxxxx	RSCQ-015-00184	RSTQ-03x-00184	RSRY-708-00531	7
2.9020 - 2.9429	73.71 - 74.75	RSKQ-200-xxxxx	RSKQ-100-xxxxx	RSCQ-015-00186	RSTQ-03x-00174	RSRY-708-00625	7
2.9331 - 2.9740	74.50 - 75.54	RSKQ-200-xxxxx	RSKQ-100-xxxxx	RSCQ-015-00188	RSTQ-03x-00176	RSRY-708-00625	7
2.9638 - 3.0051	75.28 - 76.33	RSKQ-200-xxxxx	RSKQ-100-xxxxx	RSCQ-015-00190	RSTQ-03x-00178	RSRY-708-00625	7
2.9961 - 3.0370	76.10 - 77.14	RSKQ-200-xxxxx	RSKQ-100-xxxxx	RSCQ-015-00192	RSTQ-03x-00180	RSRY-708-00625	7
3.0272 - 3.0681	76.89 - 77.93	RSKQ-200-xxxxx	RSKQ-100-xxxxx	RSCQ-015-00194	RSTQ-03x-00182	RSRY-708-00625	7
3.0579 - 3.0992	77.67 - 78.72	RSKQ-200-xxxxx	RSKQ-100-xxxxx	RSCQ-015-00196	RSTQ-03x-00184	RSRY-708-00625	7
3.0890 - 3.1299	78.46 - 79.50	RSKQ-200-xxxxx	RSKQ-100-xxxxx	RSCQ-015-00198	RSTQ-03x-00198	RSRY-708-00625	7
3.1209 - 3.1618	79.27 - 80.31	RSKQ-200-xxxxx	RSKQ-100-xxxxx	RSCQ-015-00200	RSTQ-03x-00200	RSRY-708-00625	7
3.1520 - 3.1933	80.06 - 81.11	RSKQ-200-xxxxx	RSKQ-100-xxxxx	RSCQ-015-00202	RSTQ-03x-00202	RSRY-708-00625	7
3.1831 - 3.2240	80.85 - 81.89	RSKQ-200-xxxxx	RSKQ-100-xxxxx	RSCQ-015-00204	RSTQ-03x-00204	RSRY-708-00625	7
3.2138 - 3.2551	81.63 - 82.68	RSKQ-200-xxxxx	RSKQ-100-xxxxx	RSCQ-015-00206	RSTQ-03x-00198	RSRY-708-00687	7
3.2461 - 3.2870	82.45 - 83.49	RSKQ-200-xxxxx	RSKQ-100-xxxxx	RSCQ-015-00208	RSTQ-03x-00200	RSRY-708-00687	7
3.2772 - 3.3177	83.24 - 84.27	RSKQ-200-xxxxx	RSKQ-100-xxxxx	RSCQ-015-00210	RSTQ-03x-00202	RSRY-708-00687	7
3.3079 - 3.3492	84.02 - 85.07	RSKQ-200-xxxxx	RSKQ-100-xxxxx	RSCQ-015-00212	RSTQ-03x-00204	RSRY-708-00687	7

\*xxxxx = Indicate to 2 metric decimal places the size to be burnished (e.g. roller burnisher Ø 75.00mm with MT.3 shank: RSKQ-200-07500).

\*\*x = A number that will vary from 2 to 8 depending upon the exact diameter to be burnished. See page D: 6 for the correct identification of the "x" value.

**NOTE:** Each roller burnishing tool comes assembled complete with cage, cone, and rolls.

D: 42 - 45

D: 40 - 41

D: 39

Key on D: 1

A DRILLING  
B BORING  
C REAMING  
D BURNISHING  
E THREADING  
X SPECIALS

## Roller Burnishing Tools | Through Holes

R Series | Diameter Range: 3.3390 - 4.0992" (84.81mm - 104.12mm)

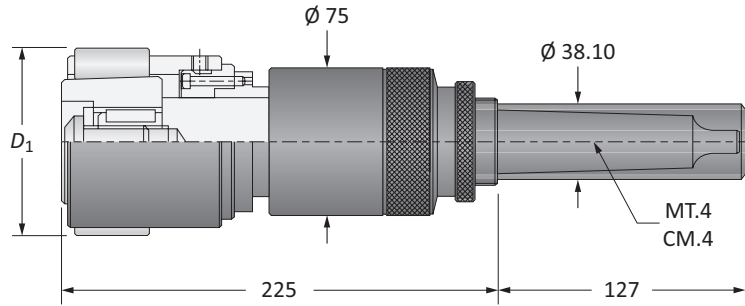

### Through Holes

$D_1$		Part No.		Spare Parts			Qty Rolls
Imperial (in)	Metric (mm)	Assembly with Morse Taper Shank	Assembly with Straight Shank	Cage	Cone	Rolls	
3.3390 - 3.3799	84.81 - 85.85	RDKR-200-08481	RDKR-100-08481	RDCR-011-00214	RDTR-073-00001	RDRY-701-00468	9
3.3713 - 3.4118	85.63 - 86.66	RDKR-200-08563	RDKR-100-08563	RDCR-011-00216	RDTR-074-00001	RDRY-701-00468	9
3.4020 - 3.4429	86.41 - 87.45	RDKR-200-08641	RDKR-100-08641	RDCR-011-00218	RDTR-071-00001	RDRY-701-00531	9
3.4331 - 3.4740	87.20 - 88.24	RDKR-200-08720	RDKR-100-08720	RDCR-011-00220	RDTR-072-00001	RDRY-701-00531	9
3.4642 - 3.5051	87.99 - 89.03	RDKR-200-08799	RDKR-100-08799	RDCR-011-00222	RDTR-073-00001	RDRY-701-00531	9
3.4957 - 3.5370	88.79 - 89.84	RDKR-200-08879	RDKR-100-08879	RDCR-011-00224	RDTR-074-00001	RDRY-701-00531	9
3.5272 - 3.5681	89.59 - 90.63	RDKR-200-08959	RDKR-100-08959	RDCR-011-00226	RDTR-075-00001	RDRY-701-00531	9
3.5579 - 3.5992	90.37 - 91.42	RDKR-200-09037	RDKR-100-09037	RDCR-011-00228	RDTR-076-00001	RDRY-701-00531	9
3.5890 - 3.6299	91.16 - 92.20	RDKR-200-09116	RDKR-100-09116	RDCR-011-00230	RDTR-071-00001	RDRY-701-00625	9
3.6209 - 3.6622	91.97 - 93.02	RDKR-200-09197	RDKR-100-09197	RDCR-011-00232	RDTR-072-00001	RDRY-701-00625	9
3.6520 - 3.6929	92.76 - 93.80	RDKR-200-09276	RDKR-100-09276	RDCR-011-00234	RDTR-073-00001	RDRY-701-00625	9
3.6831 - 3.7240	93.55 - 94.59	RDKR-200-09355	RDKR-100-09355	RDCR-011-00236	RDTR-074-00001	RDRY-701-00625	9
3.7142 - 3.7551	94.34 - 95.38	RDKR-200-09434	RDKR-100-09434	RDCR-011-00238	RDTR-075-00001	RDRY-701-00625	9
3.7461 - 3.7870	95.15 - 96.19	RDKR-200-09515	RDKR-100-09515	RDCR-011-00240	RDTR-076-00001	RDRY-701-00625	9
3.7772 - 3.8181	95.94 - 96.98	RDKR-200-09594	RDKR-100-09594	RDCR-011-00242	RDTR-077-00001	RDRY-701-00625	9
3.8079 - 3.8492	96.72 - 97.77	RDKR-200-09672	RDKR-100-09672	RDCR-011-00244	RDTR-078-00001	RDRY-701-00625	9
3.8390 - 3.8799	97.51 - 98.55	RDKR-200-09751	RDKR-100-09751	RDCR-011-00246	RDTR-075-00001	RDRY-701-00687	9
3.8709 - 3.9122	98.32 - 99.37	RDKR-200-09832	RDKR-100-09832	RDCR-011-00248	RDTR-076-00001	RDRY-701-00687	9
3.9020 - 3.9429	99.11 - 100.15	RDKR-200-09911	RDKR-100-09911	RDCR-011-00250	RDTR-077-00001	RDRY-701-00687	9
3.9331 - 3.9740	99.90 - 100.94	RDKR-200-09990	RDKR-100-09990	RDCR-011-00252	RDTR-078-00001	RDRY-701-00687	9
3.9642 - 4.0051	100.69 - 101.73	RDKR-200-10069	RDKR-100-10069	RDCR-011-00254	RDTR-079-00001	RDRY-701-00687	9
3.9961 - 4.0370	101.50 - 102.54	RDKR-200-10150	RDKR-100-10150	RDCR-011-00256	RDTR-080-00001	RDRY-701-00687	9
4.0272 - 4.0681	102.29 - 103.33	RDKR-200-10229	RDKR-100-10229	RDCR-011-00258	RDTR-081-00001	RDRY-701-00687	9
4.0579 - 4.0992	103.07 - 104.12	RDKR-200-10307	RDKR-100-10307	RDCR-011-00260	RDTR-082-00001	RDRY-701-00687	9

**NOTE:** Each roller burnishing tool comes assembled complete with cage, cone, and rolls.

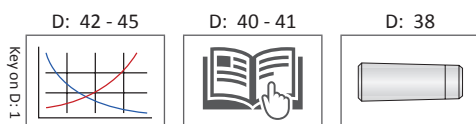





## Roller Burnishing Tools | Blind Holes

R Series | Diameter Range: 3.3390 - 4.0992" (84.81mm - 104.12mm)

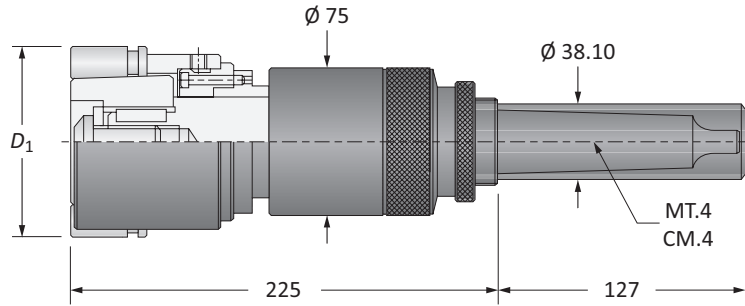

### Blind Holes

D <sub>1</sub>		Part No.*		Spare Parts			Qty Rolls
Imperial (in)	Metric (mm)	Assembly with Morse Taper Shank	Assembly with Straight Shank	Cage	Cone**	Rolls	
3.3390 - 3.3799	84.81 - 85.85	RSKR-200-xxxxx	RSKR-100-xxxxx	RSCR-015-00214	RSTR-073-0000x	RSRY-708-00468	9
3.3713 - 3.4118	85.63 - 86.66	RSKR-200-xxxxx	RSKR-100-xxxxx	RSCR-015-00216	RSTR-074-0000x	RSRY-708-00468	9
3.4020 - 3.4429	86.41 - 87.45	RSKR-200-xxxxx	RSKR-100-xxxxx	RSCR-015-00218	RSTR-071-0000x	RSRY-708-00531	9
3.4331 - 3.4740	87.20 - 88.24	RSKR-200-xxxxx	RSKR-100-xxxxx	RSCR-015-00220	RSTR-072-0000x	RSRY-708-00531	9
3.4642 - 3.5051	87.99 - 89.03	RSKR-200-xxxxx	RSKR-100-xxxxx	RSCR-015-00222	RSTR-073-0000x	RSRY-708-00531	9
3.4957 - 3.5370	88.79 - 89.84	RSKR-200-xxxxx	RSKR-100-xxxxx	RSCR-015-00224	RSTR-074-0000x	RSRY-708-00531	9
3.5272 - 3.5681	89.59 - 90.63	RSKR-200-xxxxx	RSKR-100-xxxxx	RSCR-015-00226	RSTR-075-0000x	RSRY-708-00531	9
3.5579 - 3.5992	90.37 - 91.42	RSKR-200-xxxxx	RSKR-100-xxxxx	RSCR-015-00228	RSTR-076-0000x	RSRY-708-00531	9
3.5890 - 3.6299	91.16 - 92.20	RSKR-200-xxxxx	RSKR-100-xxxxx	RSCR-015-00230	RSTR-071-0000x	RSRY-708-00625	9
3.6209 - 3.6622	91.97 - 93.02	RSKR-200-xxxxx	RSKR-100-xxxxx	RSCR-015-00232	RSTR-072-0000x	RSRY-708-00625	9
3.6520 - 3.6929	92.76 - 93.80	RSKR-200-xxxxx	RSKR-100-xxxxx	RSCR-015-00234	RSTR-073-0000x	RSRY-708-00625	9
3.6831 - 3.7240	93.55 - 94.59	RSKR-200-xxxxx	RSKR-100-xxxxx	RSCR-015-00236	RSTR-074-0000x	RSRY-708-00625	9
3.7142 - 3.7551	94.34 - 95.38	RSKR-200-xxxxx	RSKR-100-xxxxx	RSCR-015-00238	RSTR-075-0000x	RSRY-708-00625	9
3.7461 - 3.7870	95.15 - 96.19	RSKR-200-xxxxx	RSKR-100-xxxxx	RSCR-015-00240	RSTR-076-0000x	RSRY-708-00625	9
3.7772 - 3.8181	95.94 - 96.98	RSKR-200-xxxxx	RSKR-100-xxxxx	RSCR-015-00242	RSTR-077-0000x	RSRY-708-00625	9
3.8079 - 3.8492	96.72 - 97.77	RSKR-200-xxxxx	RSKR-100-xxxxx	RSCR-015-00244	RSTR-078-0000x	RSRY-708-00625	9
3.8390 - 3.8799	97.51 - 98.55	RSKR-200-xxxxx	RSKR-100-xxxxx	RSCR-015-00246	RSTR-075-0000x	RSRY-708-00687	9
3.8709 - 3.9122	98.32 - 99.37	RSKR-200-xxxxx	RSKR-100-xxxxx	RSCR-015-00248	RSTR-076-0000x	RSRY-708-00687	9
3.9020 - 3.9429	99.11 - 100.15	RSKR-200-xxxxx	RSKR-100-xxxxx	RSCR-015-00250	RSTR-077-0000x	RSRY-708-00687	9
3.9331 - 3.9740	99.90 - 100.94	RSKR-200-xxxxx	RSKR-100-xxxxx	RSCR-015-00252	RSTR-078-0000x	RSRY-708-00687	9
3.9642 - 4.0051	100.69 - 101.73	RSKR-200-xxxxx	RSKR-100-xxxxx	RSCR-015-00254	RSTR-079-0000x	RSRY-708-00687	9
3.9961 - 4.0370	101.50 - 102.54	RSKR-200-xxxxx	RSKR-100-xxxxx	RSCR-015-00256	RSTR-080-0000x	RSRY-708-00687	9
4.0272 - 1.0681	102.29 - 103.33	RSKR-200-xxxxx	RSKR-100-xxxxx	RSCR-015-00258	RSTR-081-0000x	RSRY-708-00687	9
4.0579 - 4.0992	103.07 - 104.12	RSKR-200-xxxxx	RSKR-100-xxxxx	RSCR-015-00260	RSTR-082-0000x	RSRY-708-00687	9

\*xxxxx = Indicate to 2 metric decimal places the size to be burnished (e.g. roller burnisher Ø 100.00mm with straight shank: RSKR-100-10000).

\*\*x = A number that will vary from 2 to 8 depending upon the exact diameter to be burnished. See page D: 6 for the correct identification of the "x" value.

**NOTE:** Each roller burnishing tool comes assembled complete with cage, cone, and rolls.

D: 42 - 45      D: 40 - 41      D: 39

## Roller Burnishing Tools | Through Holes

S Series | Diameter Range: 4.0890 - 5.0370" (103.86mm - 127.94mm)

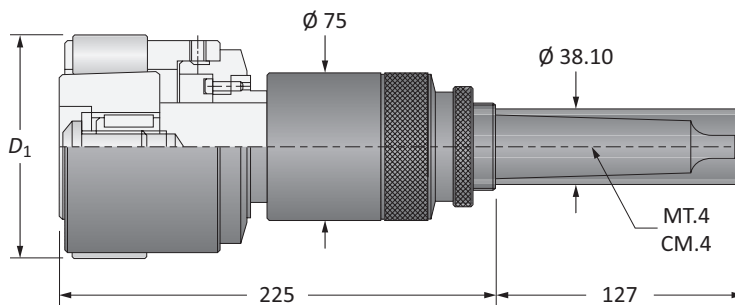

### Through Holes

D <sub>1</sub>		Part No.		Spare Parts			Qty Rolls
Imperial (in)	Metric (mm)	Assembly with Morse Taper Shank	Assembly with Straight Shank	Cage	Cone	Rolls	
4.0890 - 4.1299	103.86 - 104.90	RDKS-200-10386	RDKS-100-10386	RDCS-011-00262	RDTS-083-00001	RDRY-701-00687	9
4.1209 - 4.1634	104.67 - 105.75	RDKS-200-10467	RDKS-100-10467	RDCS-011-00264	RDTS-084-00001	RDRY-701-00687	9
4.1520 - 4.1929	105.46 - 106.50	RDKS-200-10546	RDKS-100-10546	RDCS-011-00266	RDTS-085-00001	RDRY-701-00687	9
4.1831 - 4.2240	106.25 - 107.29	RDKS-200-10625	RDKS-100-10625	RDCS-011-00268	RDTS-086-00001	RDRY-701-00687	9
4.2142 - 4.2551	107.04 - 108.08	RDKS-200-10704	RDKS-100-10704	RDCS-011-00270	RDTS-087-00001	RDRY-701-00687	9
4.2461 - 4.2870	107.85 - 108.89	RDKS-200-10785	RDKS-100-10785	RDCS-011-00272	RDTS-088-00001	RDRY-701-00687	9
4.2772 - 4.3181	108.64 - 109.68	RDKS-200-10864	RDKS-100-10864	RDCS-011-00274	RDTS-089-00001	RDRY-701-00687	9
4.3079 - 4.3492	109.42 - 110.47	RDKS-200-10942	RDKS-100-10942	RDCS-011-00276	RDTS-090-00001	RDRY-701-00687	9
4.3390 - 4.3799	110.21 - 111.25	RDKS-200-11021	RDKS-100-11021	RDCS-011-00278	RDTS-083-00001	RDRY-701-00812	9
4.3709 - 4.4122	111.02 - 112.07	RDKS-200-11102	RDKS-100-11102	RDCS-011-00280	RDTS-084-00001	RDRY-701-00812	9
4.4020 - 4.4429	111.81 - 112.85	RDKS-200-11181	RDKS-100-11181	RDCS-011-00282	RDTS-085-00001	RDRY-701-00812	9
4.4331 - 4.4740	112.60 - 113.64	RDKS-200-11260	RDKS-100-11260	RDCS-011-00284	RDTS-086-00001	RDRY-701-00812	9
4.4622 - 4.5051	113.34 - 114.43	RDKS-200-11334	RDKS-100-11334	RDCS-011-00286	RDTS-087-00001	RDRY-701-00812	9
4.4961 - 4.5370	114.20 - 115.24	RDKS-200-11420	RDKS-100-11420	RDCS-011-00288	RDTS-088-00001	RDRY-701-00812	9
4.5272 - 4.5681	114.99 - 116.03	RDKS-200-11499	RDKS-100-11499	RDCS-011-00290	RDTS-089-00001	RDRY-701-00812	9
4.5579 - 4.5992	115.77 - 116.82	RDKS-200-11577	RDKS-100-11577	RDCS-011-00292	RDTS-090-00001	RDRY-701-00812	9
4.5890 - 4.6299	116.56 - 117.60	RDKS-200-11656	RDKS-100-11656	RDCS-011-00294	RDTS-091-00001	RDRY-701-00812	9
4.6209 - 4.6622	117.37 - 118.42	RDKS-200-11737	RDKS-100-11737	RDCS-011-00296	RDTS-092-00001	RDRY-701-00812	9
4.6520 - 4.6929	118.16 - 119.20	RDKS-200-11816	RDKS-100-11816	RDCS-011-00298	RDTS-093-00001	RDRY-701-00812	9
4.6831 - 4.7240	118.95 - 119.99	RDKS-200-11895	RDKS-100-11895	RDCS-011-00300	RDTS-094-00001	RDRY-701-00812	9
4.7142 - 4.7551	119.74 - 120.78	RDKS-200-11974	RDKS-100-11974	RDCS-011-00302	RDTS-095-00001	RDRY-701-00812	9
4.7461 - 4.7870	120.55 - 121.59	RDKS-200-12055	RDKS-100-12055	RDCS-011-00304	RDTS-096-00001	RDRY-701-00812	9
4.7772 - 4.8181	121.34 - 122.38	RDKS-200-12134	RDKS-100-12134	RDCS-011-00306	RDTS-097-00001	RDRY-701-00812	9
4.8079 - 4.8492	122.12 - 123.17	RDKS-200-12212	RDKS-100-12212	RDCS-011-00308	RDTS-098-00001	RDRY-701-00812	9
4.8390 - 4.8799	122.91 - 123.95	RDKS-200-12291	RDKS-100-12291	RDCS-011-00310	RDTS-099-00001	RDRY-701-00812	9
4.8709 - 4.9122	123.72 - 124.77	RDKS-200-12372	RDKS-100-12372	RDCS-011-00312	RDTS-100-00001	RDRY-701-00812	9
4.9020 - 4.9429	124.51 - 125.55	RDKS-200-12451	RDKS-100-12451	RDCS-011-01245	RDTS-031-01245	RDRY-701-00812	9
4.9331 - 4.9740	125.30 - 126.34	RDKS-200-12530	RDKS-100-12530	RDCS-011-01255	RDTS-031-01255	RDRY-701-00812	9
4.9642 - 5.0051	126.09 - 127.13	RDKS-200-12609	RDKS-100-12609	RDCS-011-01265	RDTS-031-01265	RDRY-701-00812	9
4.9961 - 5.0370	126.90 - 127.94	RDKS-200-12690	RDKS-100-12690	RDCS-011-01275	RDTS-031-01275	RDRY-701-00812	9

**NOTE:** Each roller burnishing tool comes assembled complete with cage, cone, and rolls.

D: 42 - 45

D: 40 - 41

D: 38

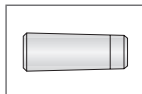
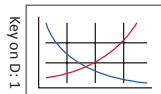

Key on D: 1



## Roller Burnishing Tools | Blind Holes

S Series | Diameter Range: 4.0890 - 5.0370" (103.86mm - 127.94mm)

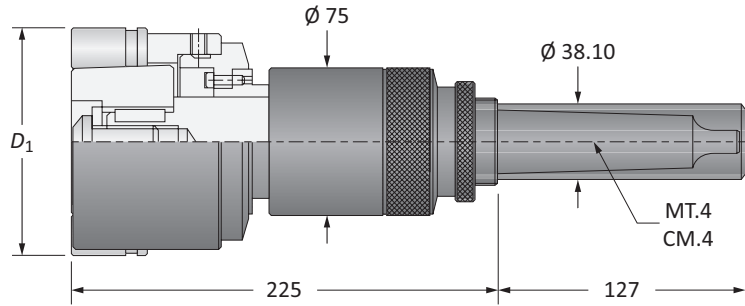

### Blind Holes

D <sub>1</sub>		Part No.*		Spare Parts			Qty Rolls
Imperial (in)	Metric (mm)	Assembly with Morse Taper Shank	Assembly with Straight Shank	Cage	Cone**	Rolls	
4.0890 - 4.1299	103.86 - 104.90	RSKS-200-xxxxx	RSKS-100-xxxxx	RSCS-015-00262	RSTS-083-0000x	RSRY-708-00687	9
4.1209 - 4.1634	104.67 - 105.75	RSKS-200-xxxxx	RSKS-100-xxxxx	RSCS-015-00264	RSTS-084-0000x	RSRY-708-00687	9
4.1520 - 4.1929	105.46 - 106.50	RSKS-200-xxxxx	RSKS-100-xxxxx	RSCS-015-00266	RSTS-085-0000x	RSRY-708-00687	9
4.1831 - 4.2240	106.25 - 107.29	RSKS-200-xxxxx	RSKS-100-xxxxx	RSCS-015-00268	RSTS-086-0000x	RSRY-708-00687	9
4.2142 - 4.2551	107.04 - 108.08	RSKS-200-xxxxx	RSKS-100-xxxxx	RSCS-015-00270	RSTS-087-0000x	RSRY-708-00687	9
4.2461 - 4.2870	107.85 - 108.89	RSKS-200-xxxxx	RSKS-100-xxxxx	RSCS-015-00272	RSTS-088-0000x	RSRY-708-00687	9
4.2772 - 4.3181	108.64 - 109.68	RSKS-200-xxxxx	RSKS-100-xxxxx	RSCS-015-00274	RSTS-089-0000x	RSRY-708-00687	9
4.3079 - 4.3492	109.42 - 110.47	RSKS-200-xxxxx	RSKS-100-xxxxx	RSCS-015-00276	RSTS-090-0000x	RSRY-708-00687	9
4.3390 - 4.3799	110.21 - 111.25	RSKS-200-xxxxx	RSKS-100-xxxxx	RSCS-015-00278	RSTS-083-0000x	RSRY-708-00812	9
4.3709 - 4.4122	111.02 - 112.07	RSKS-200-xxxxx	RSKS-100-xxxxx	RSCS-015-00280	RSTS-084-0000x	RSRY-708-00812	9
4.4020 - 4.4429	111.81 - 112.85	RSKS-200-xxxxx	RSKS-100-xxxxx	RSCS-015-00282	RSTS-085-0000x	RSRY-708-00812	9
4.4331 - 4.4740	112.60 - 113.64	RSKS-200-xxxxx	RSKS-100-xxxxx	RSCS-015-00284	RSTS-086-0000x	RSRY-708-00812	9
4.4622 - 4.5051	113.34 - 114.43	RSKS-200-xxxxx	RSKS-100-xxxxx	RSCS-015-00286	RSTS-087-0000x	RSRY-708-00812	9
4.4961 - 4.5370	114.20 - 115.24	RSKS-200-xxxxx	RSKS-100-xxxxx	RSCS-015-00288	RSTS-088-0000x	RSRY-708-00812	9
4.5272 - 4.5681	114.99 - 116.03	RSKS-200-xxxxx	RSKS-100-xxxxx	RSCS-015-00290	RSTS-089-0000x	RSRY-708-00812	9
4.5579 - 4.5992	115.77 - 116.82	RSKS-200-xxxxx	RSKS-100-xxxxx	RSCS-015-00292	RSTS-090-0000x	RSRY-708-00812	9
4.5890 - 4.6299	116.56 - 117.60	RSKS-200-xxxxx	RSKS-100-xxxxx	RSCS-015-00294	RSTS-091-0000x	RSRY-708-00812	9
4.6209 - 4.6622	117.37 - 118.42	RSKS-200-xxxxx	RSKS-100-xxxxx	RSCS-015-00296	RSTS-092-0000x	RSRY-708-00812	9
4.6520 - 4.6929	118.16 - 119.20	RSKS-200-xxxxx	RSKS-100-xxxxx	RSCS-015-00298	RSTS-093-0000x	RSRY-708-00812	9
4.6831 - 4.7240	118.95 - 119.99	RSKS-200-xxxxx	RSKS-100-xxxxx	RSCS-015-00300	RSTS-094-0000x	RSRY-708-00812	9
4.7142 - 4.7551	119.74 - 120.78	RSKS-200-xxxxx	RSKS-100-xxxxx	RSCS-015-00302	RSTS-095-0000x	RSRY-708-00812	9
4.7461 - 4.7870	120.55 - 121.59	RSKS-200-xxxxx	RSKS-100-xxxxx	RSCS-015-00304	RSTS-096-0000x	RSRY-708-00812	9
4.7772 - 4.8181	121.34 - 122.38	RSKS-200-xxxxx	RSKS-100-xxxxx	RSCS-015-00306	RSTS-097-0000x	RSRY-708-00812	9
4.8079 - 4.8492	122.12 - 123.17	RSKS-200-xxxxx	RSKS-100-xxxxx	RSCS-015-00308	RSTS-098-0000x	RSRY-708-00812	9
4.8390 - 4.8799	122.91 - 123.95	RSKS-200-xxxxx	RSKS-100-xxxxx	RSCS-015-00310	RSTS-099-0000x	RSRY-708-00812	9
4.8709 - 4.9122	123.72 - 124.77	RSKS-200-xxxxx	RSKS-100-xxxxx	RSCS-015-00312	RSTS-100-0000x	RSRY-708-00812	9
4.9020 - 4.9429	124.51 - 125.55	RSKS-200-xxxxx	RSKS-100-xxxxx	RSCS-015-01245	RSTS-03x-01245	RSRY-708-00812	9
4.9331 - 4.9740	125.30 - 126.34	RSKS-200-xxxxx	RSKS-100-xxxxx	RSCS-015-01255	RSTS-03x-01255	RSRY-708-00812	9
4.9642 - 5.0051	126.09 - 127.13	RSKS-200-xxxxx	RSKS-100-xxxxx	RSCS-015-01265	RSTS-03x-01265	RSRY-708-00812	9
4.9961 - 5.0370	126.90 - 127.94	RSKS-200-xxxxx	RSKS-100-xxxxx	RSCS-015-01275	RSTS-03x-01275	RSRY-708-00812	9

\*xxxxx = Indicate to 2 metric decimal places the size to be burnished (e.g. roller burnisher Ø 120.05mm with MT.4 shank: RSKS-200-12005).

\*\*x = A number that will vary from 2 to 8 depending upon the exact diameter to be burnished. See page D: 6 for the correct identification of the "x" value.

**NOTE:** Each roller burnishing tool comes assembled complete with cage, cone, and rolls.

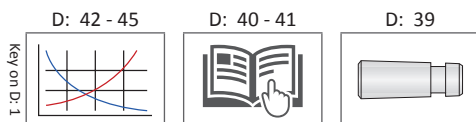

## Roller Burnishing Tools | Through Holes

T Series | Diameter Range: 5.0354 - 5.9016" (127.90mm - 149.90mm)

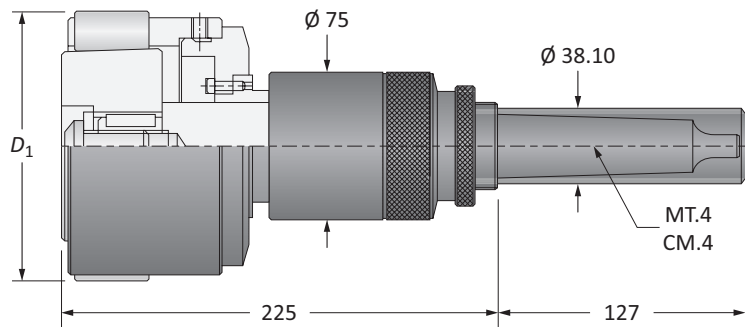

### Through Holes

$D_1$		Part No.		Spare Parts			
Imperial (in)	Metric (mm)	Assembly with Morse Taper Shank	Assembly with Straight Shank	Cage	Cone	Rolls	Qty Rolls
5.0354 - 5.0748	127.90 - 128.90	RDKT-200-12790	RDKT-100-12790	RDCT-011-01280	RDTT-031-01280	RDRY-701-00812	11
5.0748 - 5.1142	128.90 - 129.90	RDKT-200-12890	RDKT-100-12890	RDCT-011-01290	RDTT-031-01290	RDRY-701-00812	11
5.1142 - 5.1535	129.90 - 130.90	RDKT-200-12990	RDKT-100-12990	RDCT-011-01300	RDTT-031-01300	RDRY-701-00812	11
5.1535 - 5.1929	130.90 - 131.90	RDKT-200-13090	RDKT-100-13090	RDCT-011-01310	RDTT-031-01310	RDRY-701-00812	11
5.1929 - 5.2323	131.90 - 132.90	RDKT-200-13190	RDKT-100-13190	RDCT-011-01320	RDTT-031-01320	RDRY-701-00812	11
5.2323 - 5.2717	132.90 - 133.90	RDKT-200-13290	RDKT-100-13290	RDCT-011-01330	RDTT-031-01330	RDRY-701-00812	11
5.2717 - 5.3110	133.90 - 134.90	RDKT-200-13390	RDKT-100-13390	RDCT-011-01340	RDTT-031-01340	RDRY-701-00812	11
5.3110 - 5.3504	134.90 - 135.90	RDKT-200-13490	RDKT-100-13490	RDCT-011-01350	RDTT-031-01350	RDRY-701-00812	11
5.3504 - 5.3898	135.90 - 136.90	RDKT-200-13590	RDKT-100-13590	RDCT-011-01360	RDTT-031-01360	RDRY-701-00812	11
5.3898 - 5.4291	136.90 - 137.90	RDKT-200-13690	RDKT-100-13690	RDCT-011-01370	RDTT-031-01370	RDRY-701-00812	11
5.4291 - 5.4685	137.90 - 138.90	RDKT-200-13790	RDKT-100-13790	RDCT-011-01380	RDTT-031-01380	RDRY-701-00812	11
5.4685 - 5.5079	138.90 - 139.90	RDKT-200-13890	RDKT-100-13890	RDCT-011-01390	RDTT-031-01390	RDRY-701-00812	11
5.5079 - 5.5472	139.90 - 140.90	RDKT-200-13990	RDKT-100-13990	RDCT-011-01400	RDTT-031-01400	RDRY-701-00812	11
5.5472 - 5.5866	140.90 - 141.90	RDKT-200-14090	RDKT-100-14090	RDCT-011-01410	RDTT-031-01410	RDRY-701-00812	11
5.5866 - 5.6260	141.60 - 142.90	RDKT-200-14190	RDKT-100-14190	RDCT-011-01420	RDTT-031-01420	RDRY-701-00812	11
5.6260 - 5.6654	142.90 - 143.90	RDKT-200-14290	RDKT-100-14290	RDCT-011-01430	RDTT-031-01430	RDRY-701-00812	11
5.6654 - 5.7047	143.90 - 144.90	RDKT-200-14390	RDKT-100-14390	RDCT-011-01440	RDTT-031-01440	RDRY-701-00812	11
5.7047 - 5.7441	144.90 - 145.90	RDKT-200-14490	RDKT-100-14490	RDCT-011-01450	RDTT-031-01450	RDRY-701-00812	11
5.7441 - 5.7835	145.90 - 146.90	RDKT-200-14590	RDKT-100-14590	RDCT-011-01460	RDTT-031-01460	RDRY-701-00812	11
5.7835 - 5.8228	146.90 - 147.90	RDKT-200-14690	RDKT-100-14690	RDCT-011-01470	RDTT-031-01470	RDRY-701-00812	11
5.8228 - 5.8622	147.90 - 148.90	RDKT-200-14790	RDKT-100-14790	RDCT-011-01480	RDTT-031-01480	RDRY-701-00812	11
5.8622 - 5.9016	148.90 - 149.90	RDKT-200-14890	RDKT-100-14890	RDCT-011-01490	RDTT-031-01490	RDRY-701-00812	11

**NOTE:** Each roller burnishing tool comes assembled complete with cage, cone, and rolls.

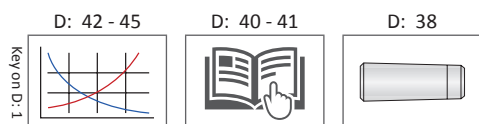



## Roller Burnishing Tools | Blind Holes

T Series | Diameter Range: 5.0354 - 5.9016" (127.90mm - 149.90mm)

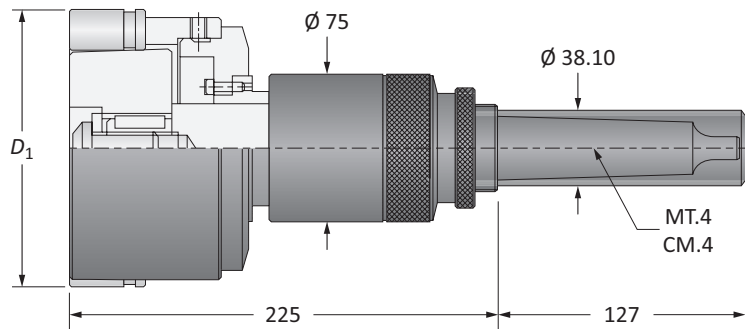

### Blind Holes

D <sub>1</sub>		Part No.*		Spare Parts			Qty Rolls
Imperial (in)	Metric (mm)	Assembly with Morse Taper Shank	Assembly with Straight Shank	Cage	Cone**	Rolls	
5.0354 - 5.0748	127.90 - 128.90	RSKT-200-xxxxx	RSKT-100-xxxxx	RSCT-015-01280	RSTT-0xx-01280	RSRY-708-00812	11
5.0748 - 5.1142	128.90 - 129.90	RSKT-200-xxxxx	RSKT-100-xxxxx	RSCT-015-01290	RSTT-0xx-01290	RSRY-708-00812	11
5.1142 - 5.1535	129.90 - 130.90	RSKT-200-xxxxx	RSKT-100-xxxxx	RSCT-015-01300	RSTT-0xx-01300	RSRY-708-00812	11
5.1535 - 5.1929	130.90 - 131.90	RSKT-200-xxxxx	RSKT-100-xxxxx	RSCT-015-01310	RSTT-0xx-01310	RSRY-708-00812	11
5.1929 - 5.2323	131.90 - 132.90	RSKT-200-xxxxx	RSKT-100-xxxxx	RSCT-015-01320	RSTT-0xx-01320	RSRY-708-00812	11
5.2323 - 5.2717	132.90 - 133.90	RSKT-200-xxxxx	RSKT-100-xxxxx	RSCT-015-01330	RSTT-0xx-01330	RSRY-708-00812	11
5.2717 - 5.3110	133.90 - 134.90	RSKT-200-xxxxx	RSKT-100-xxxxx	RSCT-015-01340	RSTT-0xx-01340	RSRY-708-00812	11
5.3110 - 5.3504	134.90 - 135.90	RSKT-200-xxxxx	RSKT-100-xxxxx	RSCT-015-01350	RSTT-0xx-01350	RSRY-708-00812	11
5.3504 - 5.3898	135.90 - 136.90	RSKT-200-xxxxx	RSKT-100-xxxxx	RSCT-015-01360	RSTT-0xx-01360	RSRY-708-00812	11
5.3898 - 5.4291	136.90 - 137.90	RSKT-200-xxxxx	RSKT-100-xxxxx	RSCT-015-01370	RSTT-0xx-01370	RSRY-708-00812	11
5.4291 - 5.4685	137.90 - 138.90	RSKT-200-xxxxx	RSKT-100-xxxxx	RSCT-015-01380	RSTT-0xx-01380	RSRY-708-00812	11
5.4685 - 5.5079	138.90 - 139.90	RSKT-200-xxxxx	RSKT-100-xxxxx	RSCT-015-01390	RSTT-0xx-01390	RSRY-708-00812	11
5.5079 - 5.5472	139.90 - 140.90	RSKT-200-xxxxx	RSKT-100-xxxxx	RSCT-015-01400	RSTT-0xx-01400	RSRY-708-00812	11
5.5472 - 5.5866	140.90 - 141.90	RSKT-200-xxxxx	RSKT-100-xxxxx	RSCT-015-01410	RSTT-0xx-01410	RSRY-708-00812	11
5.5866 - 5.6260	141.60 - 142.90	RSKT-200-xxxxx	RSKT-100-xxxxx	RSCT-015-01420	RSTT-0xx-01420	RSRY-708-00812	11
5.6260 - 5.6654	142.90 - 143.90	RSKT-200-xxxxx	RSKT-100-xxxxx	RSCT-015-01430	RSTT-0xx-01430	RSRY-708-00812	11
5.6654 - 5.7047	143.90 - 144.90	RSKT-200-xxxxx	RSKT-100-xxxxx	RSCT-015-01440	RSTT-0xx-01440	RSRY-708-00812	11
5.7047 - 5.7441	144.90 - 145.90	RSKT-200-xxxxx	RSKT-100-xxxxx	RSCT-015-01450	RSTT-0xx-01450	RSRY-708-00812	11
5.7441 - 5.7835	145.90 - 146.90	RSKT-200-xxxxx	RSKT-100-xxxxx	RSCT-015-01460	RSTT-0xx-01460	RSRY-708-00812	11
5.7835 - 5.8228	146.90 - 147.90	RSKT-200-xxxxx	RSKT-100-xxxxx	RSCT-015-01470	RSTT-0xx-01470	RSRY-708-00812	11
5.8228 - 5.8622	147.90 - 148.90	RSKT-200-xxxxx	RSKT-100-xxxxx	RSCT-015-01480	RSTT-0xx-01480	RSRY-708-00812	11
5.8622 - 5.9016	148.90 - 149.90	RSKT-200-xxxxx	RSKT-100-xxxxx	RSCT-015-01490	RSTT-0xx-01490	RSRY-708-00812	11

\*xxxxx = Indicate to 2 metric decimal places the size to be burnished (e.g. roller burnisher Ø 140.00mm with straight shank: RSKT-100-14000).

\*\*x = A number that will vary from 2 to 8 depending upon the exact diameter to be burnished. See page D: 6 for the correct identification of the "x" value.

**NOTE:** Each roller burnishing tool comes assembled complete with cage, cone, and rolls.

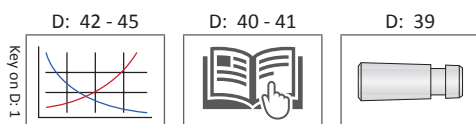

T  
A  
DRILLING  
B  
BORING  
C  
REAMING  
D  
BURNISHING  
E  
THREADING  
X  
SPECIALS

## Roller Burnishing Tools | Through Holes

U Series | Diameter Range: 5.9016" - 6.5315" (149.90mm - 165.90mm)

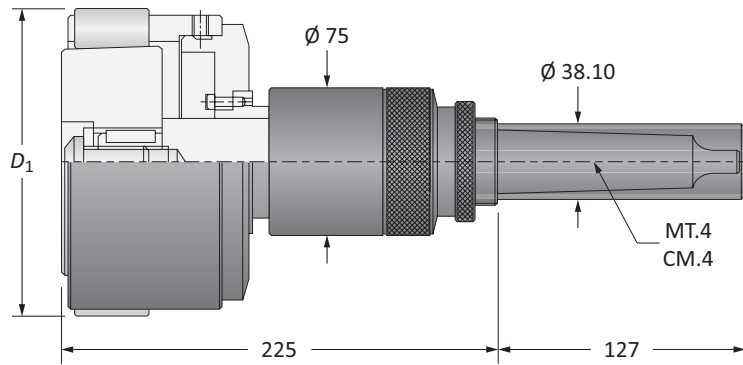

### Through Holes

$D_1$		Part No.		Spare Parts				Qty Rolls
Imperial (in)	Metric (mm)	Assembly with Morse Taper Shank	Assembly with Straight Shank	Cage	Cone	Rolls		
5.9016 - 5.9409	149.90 - 150.90	<b>RDKU-200-14990</b>	<b>RDKU-100-14990</b>	RDCU-011-01500	RDTU-031-01500	RDRY-701-00812	13	
5.9409 - 5.9803	150.90 - 151.90	<b>RDKU-200-15090</b>	<b>RDKU-100-15090</b>	RDCU-011-01510	RDTU-031-01510	RDRY-701-00812	13	
5.9803 - 6.0197	151.90 - 152.90	<b>RDKU-200-15190</b>	<b>RDKU-100-15190</b>	RDCU-011-01520	RDTU-031-01520	RDRY-701-00812	13	
6.0197 - 6.0591	152.90 - 153.90	<b>RDKU-200-15290</b>	<b>RDKU-100-15290</b>	RDCU-011-01530	RDTU-031-01530	RDRY-701-00812	13	
6.0591 - 6.0984	153.90 - 154.90	<b>RDKU-200-15390</b>	<b>RDKU-100-15390</b>	RDCU-011-01540	RDTU-031-01540	RDRY-701-00812	13	
6.0984 - 6.1378	154.90 - 155.90	<b>RDKU-200-15490</b>	<b>RDKU-100-15490</b>	RDCU-011-01550	RDTU-031-01550	RDRY-701-00812	13	
6.1378 - 6.1772	155.90 - 156.90	<b>RDKU-200-15590</b>	<b>RDKU-100-15590</b>	RDCU-011-01560	RDTU-031-01560	RDRY-701-00812	13	
6.1772 - 6.2165	156.90 - 157.90	<b>RDKU-200-15690</b>	<b>RDKU-100-15690</b>	RDCU-011-01570	RDTU-031-01570	RDRY-701-00812	13	
6.2165 - 6.2559	157.90 - 158.90	<b>RDKU-200-15790</b>	<b>RDKU-100-15790</b>	RDCU-011-01580	RDTU-031-01580	RDRY-701-00812	13	
6.2559 - 6.2953	158.90 - 159.90	<b>RDKU-200-15890</b>	<b>RDKU-100-15890</b>	RDCU-011-01590	RDTU-031-01590	RDRY-701-00812	13	
6.2953 - 6.3346	159.90 - 160.90	<b>RDKU-200-15990</b>	<b>RDKU-100-15990</b>	RDCU-011-01600	RDTU-031-01600	RDRY-701-00812	13	
6.3346 - 6.3740	160.90 - 161.90	<b>RDKU-200-16090</b>	<b>RDKU-100-16090</b>	RDCU-011-01610	RDTU-031-01610	RDRY-701-00812	13	
6.3740 - 6.4134	161.90 - 162.90	<b>RDKU-200-16190</b>	<b>RDKU-100-16190</b>	RDCU-011-01620	RDTU-031-01620	RDRY-701-00812	13	
6.4134 - 6.4528	162.90 - 163.90	<b>RDKU-200-16290</b>	<b>RDKU-100-16290</b>	RDCU-011-01630	RDTU-031-01630	RDRY-701-00812	13	
6.4528 - 6.4921	163.90 - 164.90	<b>RDKU-200-16390</b>	<b>RDKU-100-16390</b>	RDCU-011-01640	RDTU-031-01640	RDRY-701-00812	13	
6.4921 - 6.5315	164.90 - 165.90	<b>RDKU-200-16490</b>	<b>RDKU-100-16490</b>	RDCU-011-01650	RDTU-031-01650	RDRY-701-00812	13	

**NOTE:** Each roller burnishing tool comes assembled complete with cage, cone, and rolls.

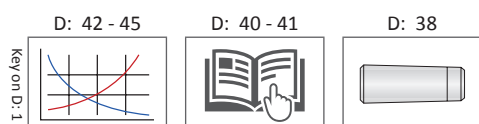



## Roller Burnishing Tools | Blind Holes

U Series | Diameter Range: 5.9016" - 6.5315" (149.90mm - 165.90mm)

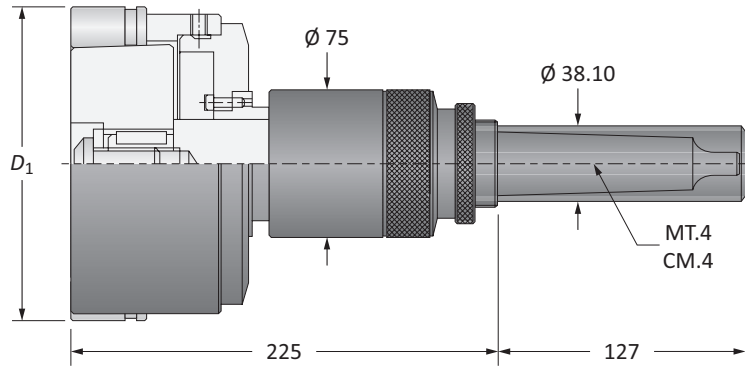

### Blind Holes

$D_1$		Part No.*		Spare Parts			Qty Rolls
Imperial (in)	Metric (mm)	Assembly with Morse Taper Shank	Assembly with Straight Shank	Cage	Cone**	Rolls	
5.9016 - 5.9409	149.90 - 150.90	RSKU-200-xxxxx	RSKU-100-xxxxx	RSCU-015-01500	RSTU-0xx-01500	RSRY-708-00812	13
5.9409 - 5.9803	150.90 - 151.90	RSKU-200-xxxxx	RSKU-100-xxxxx	RSCU-015-01510	RSTU-0xx-01510	RSRY-708-00812	13
5.9803 - 6.0197	151.90 - 152.90	RSKU-200-xxxxx	RSKU-100-xxxxx	RSCU-015-01520	RSTU-0xx-01520	RSRY-708-00812	13
6.0197 - 6.0591	152.90 - 153.90	RSKU-200-xxxxx	RSKU-100-xxxxx	RSCU-015-01530	RSTU-0xx-01530	RSRY-708-00812	13
6.0591 - 6.0984	153.90 - 154.90	RSKU-200-xxxxx	RSKU-100-xxxxx	RSCU-015-01540	RSTU-0xx-01540	RSRY-708-00812	13
6.0984 - 6.1378	154.90 - 155.90	RSKU-200-xxxxx	RSKU-100-xxxxx	RSCU-015-01550	RSTU-0xx-01550	RSRY-708-00812	13
6.1378 - 6.1772	155.90 - 156.90	RSKU-200-xxxxx	RSKU-100-xxxxx	RSCU-015-01560	RSTU-0xx-01560	RSRY-708-00812	13
6.1772 - 6.2165	156.90 - 157.90	RSKU-200-xxxxx	RSKU-100-xxxxx	RSCU-015-01570	RSTU-0xx-01570	RSRY-708-00812	13
6.2165 - 6.2559	157.90 - 158.90	RSKU-200-xxxxx	RSKU-100-xxxxx	RSCU-015-01580	RSTU-0xx-01580	RSRY-708-00812	13
6.2559 - 6.2953	158.90 - 159.90	RSKU-200-xxxxx	RSKU-100-xxxxx	RSCU-015-01590	RSTU-0xx-01590	RSRY-708-00812	13
6.2953 - 6.3346	159.90 - 160.90	RSKU-200-xxxxx	RSKU-100-xxxxx	RSCU-015-01600	RSTU-0xx-01600	RSRY-708-00812	13
6.3346 - 6.3740	160.90 - 161.90	RSKU-200-xxxxx	RSKU-100-xxxxx	RSCU-015-01610	RSTU-0xx-01610	RSRY-708-00812	13
6.3740 - 6.4134	161.90 - 162.90	RSKU-200-xxxxx	RSKU-100-xxxxx	RSCU-015-01620	RSTU-0xx-01620	RSRY-708-00812	13
6.4134 - 6.4528	162.90 - 163.90	RSKU-200-xxxxx	RSKU-100-xxxxx	RSCU-015-01630	RSTU-0xx-01630	RSRY-708-00812	13
6.4528 - 6.4921	163.90 - 164.90	RSKU-200-xxxxx	RSKU-100-xxxxx	RSCU-015-01640	RSTU-0xx-01640	RSRY-708-00812	13
6.4921 - 6.5315	164.90 - 165.90	RSKU-200-xxxxx	RSKU-100-xxxxx	RSCU-015-01650	RSTU-0xx-01650	RSRY-708-00812	13

\*xxxxx = Indicate to 2 metric decimal places the size to be burnished (e.g. roller burnisher  $\varnothing$  160.00mm with MT.4 shank: RSKU-200-16000).

\*\*x = A number that will vary from 2 to 8 depending upon the exact diameter to be burnished. See page D: 6 for the correct identification of the "x" value.

**NOTE:** Each roller burnishing tool comes assembled complete with cage, cone, and rolls.

Key on D: 1

D: 42 - 45

D: 40 - 41

D: 39

U  
A  
DRILLING  
B  
BORING  
C  
REAMING  
D  
BURNISHING  
E  
THREADING  
X  
SPECIALS

## Rolls

### Through Holes

#### Rolls 704 and 707

Part No.	Imperial (in)		Metric (mm)	
	D	L	D	L
RDRY-704-00047	0.0465	0.2500	1.18	6.35
RDRY-704-00062	0.0618	0.2500	1.57	6.35
RDRY-704-00070	0.0697	0.3126	1.77	7.94
RDRY-704-00078	0.0776	0.3752	1.97	9.53
RDRY-704-00086	0.0854	0.3752	2.17	9.53
RDRY-704-00093	0.0929	0.3752	2.36	9.53
RDRY-704-00109	0.1083	0.5000	2.75	12.70
RDRY-704-00125	0.1244	0.5000	3.16	12.70
RDRY-704-00148	0.1472	0.5000	3.74	12.70
RDRY-704-00156	0.1555	0.5000	3.95	12.70
RDRY-704-00172	0.1709	0.6252	4.34	15.88
RDRY-704-00187	0.1858	0.8772	4.72	22.28
RDRY-707-00187	0.1870	0.5000	4.75	12.70
RDRY-704-00218	0.2173	0.5000	5.52	12.70
RDRY-707-00218	0.2173	1.0000	5.52	25.40
RDRY-704-00265	0.2638	1.1252	6.70	28.58
RDRY-704-00312	0.3110	1.5000	7.90	38.10
RDRY-707-00312	0.3118	1.1252	7.92	28.58
RDRY-704-00406	0.4047	1.5000	10.28	38.10
RDRY-704-00468	0.4669	1.5000	11.86	38.10
RDRY-704-00531	0.5299	1.5000	13.46	38.10
RDRY-704-00625	0.6240	1.5000	15.85	38.10
RDRY-704-00687	0.6858	1.5000	17.42	38.10
RDRY-704-00812	0.8110	1.5000	20.60	38.10

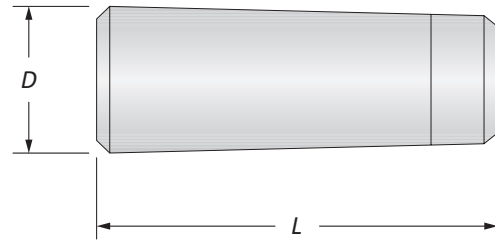

#### Rolls 701

Part No.	Imperial (in)		Metric (mm)	
	D	L	D	L
RDRY-701-00187	0.1831	0.8772	4.65	22.28
RDRY-701-00218	0.2138	1.0000	5.43	25.40
RDRY-701-00265	0.2610	1.1252	6.63	28.58
RDRY-701-00312	0.3039	1.5000	7.72	38.10
RDRY-701-00406	0.3980	1.5000	10.11	38.10
RDRY-701-00468	0.4598	1.5000	11.68	38.10
RDRY-701-00531	0.5228	1.5000	13.28	38.10
RDRY-701-00625	0.6169	1.5000	15.67	38.10
RDRY-701-00687	0.6799	1.5000	17.27	38.10
RDRY-701-00812	0.8039	1.5000	20.42	38.10

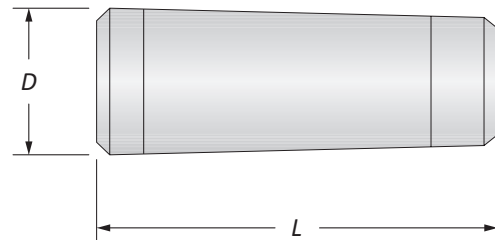



## Rolls

### Blind Holes

#### Rolls 708

Part No.	Imperial (in)		Metric (mm)	
	<i>D</i>	<i>L</i>	<i>D</i>	<i>L</i>
RSRY-708-00086	0.0854	0.3752	2.17	9.53
RSRY-708-00125	0.1244	0.5000	3.16	12.70
RSRY-708-00156	0.1555	0.5000	3.95	12.70
RSRY-708-00172	0.1709	0.6252	4.35	15.88
RSRY-708-00187	0.1858	0.8772	4.72	22.28
RSRY-708-00218	0.2173	0.5000	5.52	25.40
RSRY-708-00265	0.2638	1.1252	6.70	28.58
RSRY-708-00312	0.3110	1.5000	7.90	38.10
RSRY-708-00406	0.4047	1.5000	10.29	38.10
RSRY-708-00468	0.4669	1.5000	11.86	38.10
RSRY-708-00531	0.5299	1.5000	13.46	38.10
RSRY-708-00625	0.6240	1.5000	15.85	38.10
RSRY-708-00687	0.6858	1.5000	17.42	38.10
RSRY-708-00812	0.8110	1.5000	20.60	38.10

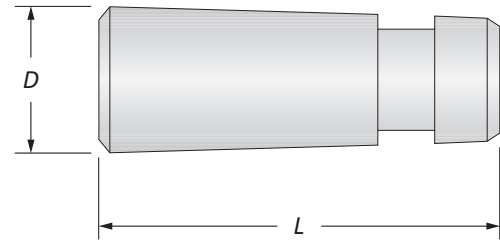

A

DRILLING

B

BORING

C

REAMING

**D**

BURNISHING

E

THREADING

X

SPECIALS

## Diameter Adjustment

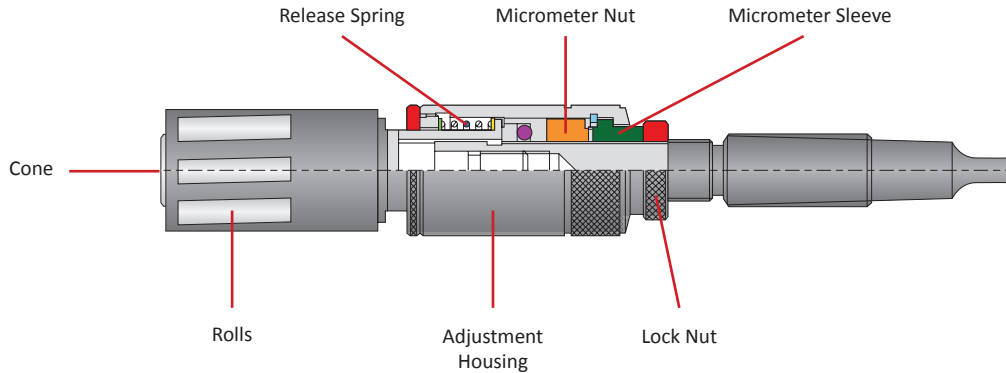

### Adjustment

The roller burnishing tool incorporates a shank, a body, and a planetary system of conical rolls that are evenly spaced by a retaining cage.

1. Unscrew the lock nut.
2. Pull the housing toward the lock nut and rotate to increase or decrease the diameter.
3. Tighten the lock nut.

**IMPORTANT:** As you increase the diameter, the cone moves forward, pushing the rolls outward. Because of this, the cone will protrude from the end of the cage, decreasing the clearance available in blind holes (see Figures 1 and 2).

Refer to chart below for clearance values.

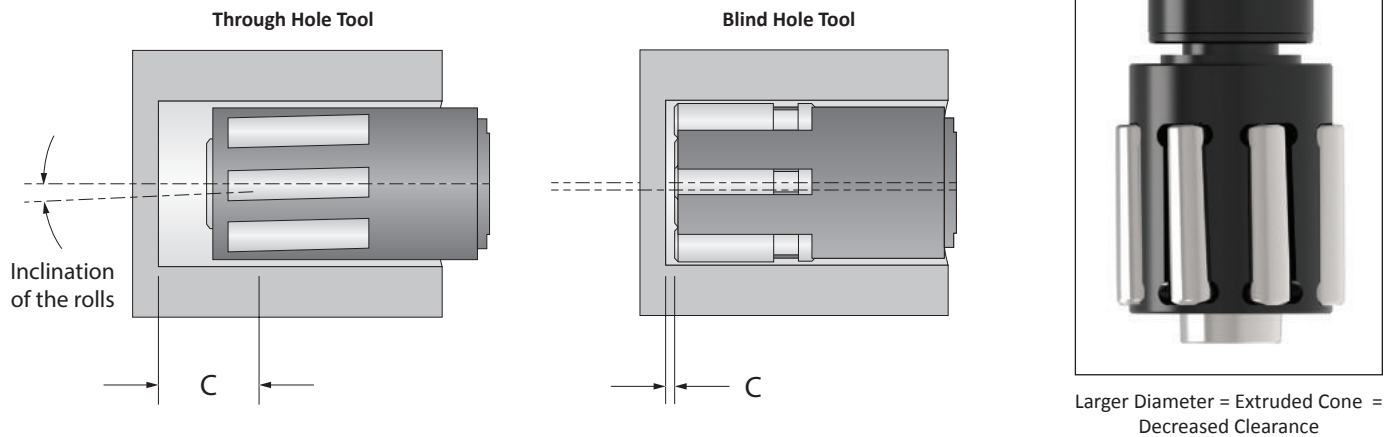

Adjustment Range		Clearance (C)		
		Through Holes		Blind Holes
Imperial (inch)	Metric (mm)	Rolls 701	Rolls 704 / 707	Rolls 708
0.1850 - 0.2315	4.70 - 5.88	–	2.40	–
0.2319 - 0.3728	5.89 - 9.47	–	2.40	0.60
0.3732 - 0.6236	9.48 - 15.84	–	2.40	0.60
0.6240 - 1.1236	15.85 - 28.54	5.40	3.20	1.00
1.1240 - 1.8385	28.55 - 46.70	9.50	3.20	1.00
1.8390 - 3.3386	46.71 - 84.80	9.50	4.00	1.00
3.3390 - 6.5315	84.81 - 165.90	10.30	4.70	1.00

A DRILLING  
B BORING  
C REAMING  
D BURNISHING  
E THREADING  
X SPECIALS

## How it Works

### Roller Burnishing Tools

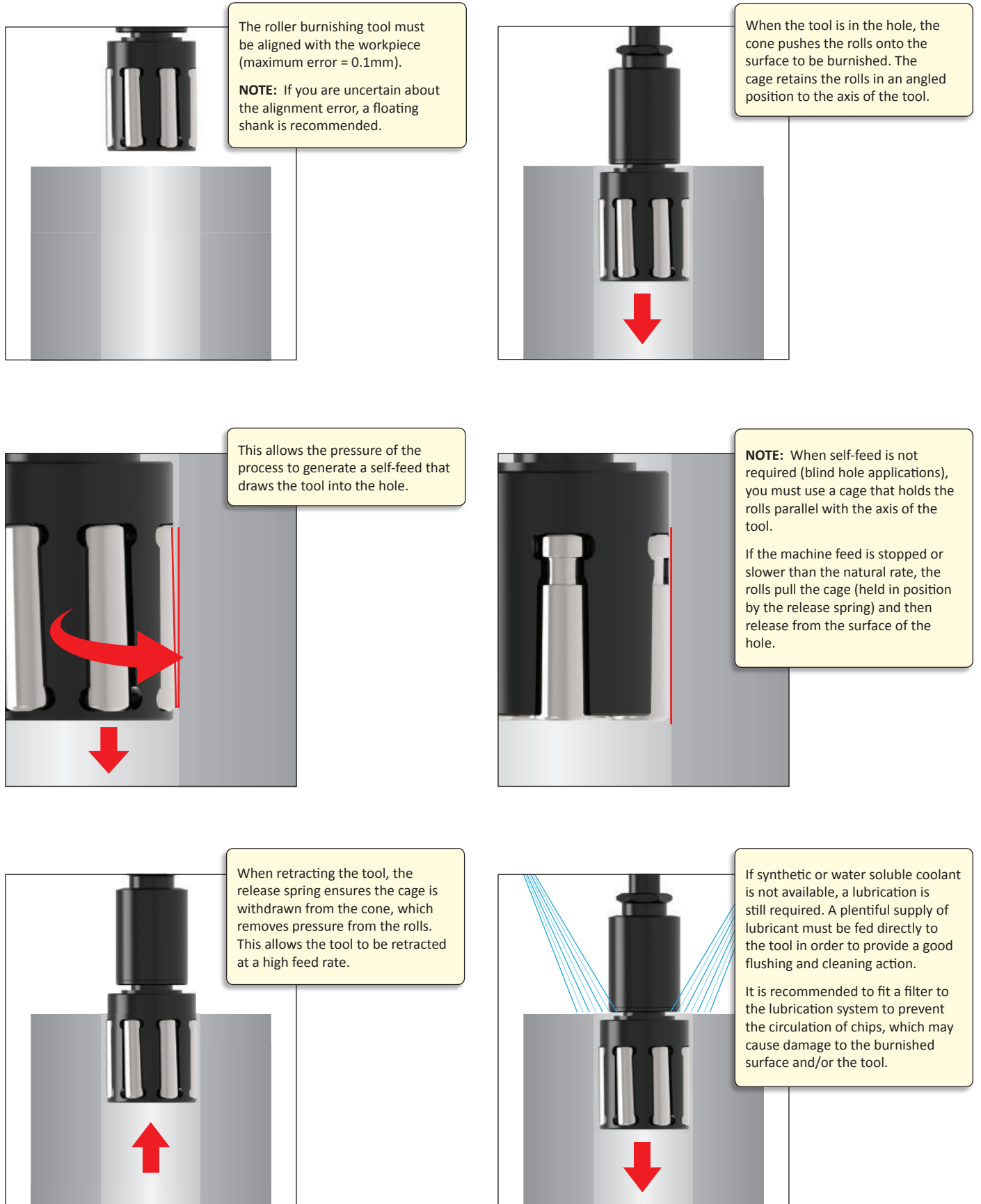

## Recommended Cutting Data | Imperial (inch)

### Roller Burnishing

ISO	Material	Hardness (BHN)	Speed (SFM)	Recommended Feed (IPR) by Burnisher Diameter			
				0.1850 - 0.4724	0.4725 - 0.9843	0.9844 - 1.9685	1.9686 - 6.5315
P	Free Machining Steel 1118, 1215, 12L14, etc.	100 - 180	75 - 300	0.005 - 0.020	0.014 - 0.037	0.032 - 0.086	0.070 - 0.121
		180 - 250	75 - 300	0.005 - 0.020	0.014 - 0.037	0.032 - 0.086	0.070 - 0.121
	Low Carbon Steel 1010, 1020, 1025, 1522, 1144, etc.	85 - 180	75 - 300	0.005 - 0.020	0.014 - 0.037	0.032 - 0.086	0.070 - 0.121
		180 - 275	75 - 300	0.005 - 0.020	0.014 - 0.037	0.032 - 0.086	0.070 - 0.121
	Medium Carbon Steel 1030, 1040, 1050, 1527, 1140, 1151, etc.	125 - 180	75 - 300	0.005 - 0.020	0.014 - 0.037	0.032 - 0.086	0.070 - 0.121
		180 - 325	75 - 300	0.005 - 0.020	0.014 - 0.037	0.032 - 0.086	0.070 - 0.121
	Alloy Steel 4140, 5140, 8640, etc.	125 - 180	75 - 300	0.005 - 0.020	0.014 - 0.037	0.032 - 0.086	0.070 - 0.121
		180 - 375	75 - 300	0.005 - 0.020	0.014 - 0.037	0.032 - 0.086	0.070 - 0.121
	High Strength Alloy 4340, 4330V, 300M, etc.	240 - 450	75 - 300	0.005 - 0.020	0.014 - 0.037	0.032 - 0.086	0.070 - 0.121
	Structural Steel A36, A285, A516, etc.	125 - 180	75 - 300	0.005 - 0.020	0.014 - 0.037	0.032 - 0.086	0.070 - 0.121
180 - 350		75 - 300	0.005 - 0.020	0.014 - 0.037	0.032 - 0.086	0.070 - 0.121	
Tool Steel H-13, H-21, A-4, O-2, S-3, etc.	150 - 200	75 - 300	0.005 - 0.020	0.014 - 0.037	0.032 - 0.086	0.070 - 0.121	
	200 - 250	75 - 300	0.005 - 0.020	0.014 - 0.037	0.032 - 0.086	0.070 - 0.121	
S	High Temp Alloy Hastelloy B, Inconel 600, etc.	140 - 310	50 - 150	0.005 - 0.020	0.014 - 0.037	0.032 - 0.086	0.070 - 0.121
		Titanium Alloy	140 - 310	50 - 150	0.005 - 0.020	0.014 - 0.037	0.032 - 0.086
M	Stainless Steel 400 Series 416, 420, etc.	135 - 350	75 - 200	0.005 - 0.020	0.014 - 0.037	0.032 - 0.086	0.070 - 0.121
		Stainless Steel 300 Series 304, 316, 17-4PH, etc.	135 - 275	75 - 200	0.005 - 0.020	0.014 - 0.037	0.032 - 0.086
K	Grey Cast Iron, Ductile Iron, Spheroidal Cast Iron (Pearlitic) Spheroidal Cast Iron (Ferritic)	< 200	75 - 300	0.005 - 0.020	0.014 - 0.037	0.032 - 0.086	0.070 - 0.121
		> 200	75 - 300	0.005 - 0.020	0.014 - 0.037	0.032 - 0.086	0.070 - 0.121
		260 - 320	75 - 300	0.005 - 0.020	0.014 - 0.037	0.032 - 0.086	0.070 - 0.121
N	Copper and Alloys Brass	< 500	150 - 350	0.005 - 0.020	0.014 - 0.037	0.032 - 0.086	0.070 - 0.121
		Bronze Bronze Phosphorous	< 180	150 - 350	0.005 - 0.020	0.014 - 0.037	0.032 - 0.086
	Aluminum and Alloys	< 150	150 - 350	0.005 - 0.020	0.014 - 0.037	0.032 - 0.086	0.070 - 0.121

#### Max RPM

Series	Max RPM
H	2000
I	1500
K	1200
L	1000
F	1000
M	900
N	900
O	700
P	600
Q	500
R	300
S	300
T	250
U	200

**IMPORTANT:** The speeds and feeds listed on these pages are a general starting point for all applications. Factory technical assistance is available through our Application Engineering department.

## Stock Allowance | Imperial (inch)

### Roller Burnishing

ISO	Material	Hardness (BHN)	Recommended Stock (inch) by Burnisher Diameter*			
			0.1850 - 0.4724	0.4725 - 0.9843	0.9844 - 1.9685	1.9686 - 6.5315
P	Free Machining Steel 1118, 1215, 12L14, etc.	100 - 180	0.0004 - 0.0007	0.0007 - 0.0016	0.0010 - 0.0018	0.0012 - 0.0020
		180 - 250	0.0004 - 0.0007	0.0007 - 0.0016	0.0010 - 0.0018	0.0012 - 0.0020
	Low Carbon Steel 1010, 1020, 1025, 1522, 1144, etc.	85 - 180	0.0004 - 0.0007	0.0007 - 0.0016	0.0010 - 0.0018	0.0012 - 0.0020
		180 - 275	0.0004 - 0.0007	0.0007 - 0.0016	0.0010 - 0.0018	0.0012 - 0.0020
	Medium Carbon Steel 1030, 1040, 1050, 1527, 1140, 1151, etc.	125 - 180	0.0004 - 0.0007	0.0007 - 0.0016	0.0010 - 0.0018	0.0012 - 0.0020
		180 - 325	0.0004 - 0.0007	0.0005 - 0.0007	0.0005 - 0.0010	0.0008 - 0.0014
	Alloy Steel 4140, 5140, 8640, etc.	125 - 180	0.0004 - 0.0007	0.0007 - 0.0016	0.0010 - 0.0018	0.0012 - 0.0020
		180 - 375	0.0004 - 0.0007	0.0005 - 0.0007	0.0005 - 0.0010	0.0008 - 0.0014
	High Strength Alloy 4340, 4330V, 300M, etc.	240 - 450	0.0004 - 0.0007	0.0005 - 0.0007	0.0005 - 0.0010	0.0008 - 0.0014
	Structural Steel A36, A285, A516, etc.	125 - 180	0.0004 - 0.0007	0.0007 - 0.0016	0.0010 - 0.0018	0.0012 - 0.0020
180 - 350		0.0004 - 0.0007	0.0005 - 0.0007	0.0005 - 0.0010	0.0008 - 0.0014	
Tool Steel H-13, H-21, A-4, O-2, S-3, etc.	150 - 200	0.0004 - 0.0007	0.0007 - 0.0016	0.0010 - 0.0018	0.0012 - 0.0020	
	200 - 250	0.0004 - 0.0007	0.0005 - 0.0007	0.0005 - 0.0010	0.0008 - 0.0014	
S	High Temp Alloy Hastelloy B, Inconel 600, etc.	140 - 310	0.0004 - 0.0007	0.0005 - 0.0007	0.0005 - 0.0010	0.0008 - 0.0014
	Titanium Alloy	140 - 310	0.0004 - 0.0007	0.0005 - 0.0007	0.0005 - 0.0010	0.0008 - 0.0014
M	Stainless Steel 400 Series 416, 420, etc.	135 - 350	0.0004 - 0.0007	0.0007 - 0.0016	0.0010 - 0.0018	0.0012 - 0.0020
	Stainless Steel 300 Series 304, 316, 17-4PH, etc.	135 - 275	0.0004 - 0.0007	0.0007 - 0.0016	0.0010 - 0.0018	0.0012 - 0.0020
K	Grey Cast Iron, Ductile Iron, Spheroidal Cast Iron (Pearlitic)	< 200	0.0004 - 0.0007	0.0005 - 0.0007	0.0005 - 0.0010	0.0008 - 0.0014
		> 200	0.0004 - 0.0007	0.0005 - 0.0007	0.0005 - 0.0010	0.0008 - 0.0014
	Spheroidal Cast Iron (Ferritic)	260 - 320	0.0004 - 0.0007	0.0005 - 0.0007	0.0005 - 0.0010	0.0008 - 0.0014
N	Copper and Alloys Brass	< 500	0.0004 - 0.0007	0.0007 - 0.0016	0.0010 - 0.0018	0.0012 - 0.0020
	Bronze	< 180	0.0004 - 0.0007	0.0007 - 0.0016	0.0010 - 0.0018	0.0012 - 0.0020
	Bronze Phosphorous	< 180	0.0004 - 0.0007	0.0007 - 0.0016	0.0010 - 0.0018	0.0012 - 0.0020
	Aluminum and Alloys	< 150	0.0004 - 0.0007	0.0007 - 0.0016	0.0010 - 0.0018	0.0012 - 0.0020

\*Stock value is on diameter.

A  
DRILLING  
B  
BORING  
C  
REAMING  
D  
BURNISHING  
E  
THREADING  
X  
SPECIALS

## Recommended Cutting Data | Metric (mm)

### Roller Burnishing

ISO	Material	Hardness (BHN)	Speed (M/min)	Recommended Feed (mm/rev) by Burnisher Diameter			
				4.70 - 12.00	12.01 - 25.00	25.01 - 50.00	50.01 - 165.90
P	Free Machining Steel 1118, 1215, 12L14, etc.	100 - 180	22 - 90	0.13 - 0.51	0.36 - 0.94	0.81 - 2.18	1.78 - 3.07
		180 - 250	22 - 90	0.13 - 0.51	0.36 - 0.94	0.81 - 2.18	1.78 - 3.07
	Low Carbon Steel 1010, 1020, 1025, 1522, 1144, etc.	85 - 180	22 - 90	0.13 - 0.51	0.36 - 0.94	0.81 - 2.18	1.78 - 3.07
		180 - 275	22 - 90	0.13 - 0.51	0.36 - 0.94	0.81 - 2.18	1.78 - 3.07
	Medium Carbon Steel 1030, 1040, 1050, 1527, 1140, 1151, etc.	125 - 180	22 - 90	0.13 - 0.51	0.36 - 0.94	0.81 - 2.18	1.78 - 3.07
		180 - 325	22 - 90	0.13 - 0.51	0.36 - 0.94	0.81 - 2.18	1.78 - 3.07
	Alloy Steel 4140, 5140, 8640, etc.	125 - 180	22 - 90	0.13 - 0.51	0.36 - 0.94	0.81 - 2.18	1.78 - 3.07
		180 - 375	22 - 90	0.13 - 0.51	0.36 - 0.94	0.81 - 2.18	1.78 - 3.07
	High Strength Alloy 4340, 4330V, 300M, etc.	240 - 450	22 - 90	0.13 - 0.51	0.36 - 0.94	0.81 - 2.18	1.78 - 3.07
	Structural Steel A36, A285, A516, etc.	125 - 180	22 - 90	0.13 - 0.51	0.36 - 0.94	0.81 - 2.18	1.78 - 3.07
180 - 350		22 - 90	0.13 - 0.51	0.36 - 0.94	0.81 - 2.18	1.78 - 3.07	
Tool Steel H-13, H-21, A-4, O-2, S-3, etc.	150 - 200	22 - 90	0.13 - 0.51	0.36 - 0.94	0.81 - 2.18	1.78 - 3.07	
	200 - 250	22 - 90	0.13 - 0.51	0.36 - 0.94	0.81 - 2.18	1.78 - 3.07	
S	High Temp Alloy Hastelloy B, Inconel 600, etc.	140 - 310	15 - 45	0.13 - 0.51	0.36 - 0.94	0.81 - 2.18	1.78 - 3.07
	Titanium Alloy	140 - 310	15 - 45	0.13 - 0.51	0.36 - 0.94	0.81 - 2.18	1.78 - 3.07
M	Stainless Steel 400 Series 416, 420, etc.	135 - 350	22 - 60	0.13 - 0.51	0.36 - 0.94	0.81 - 2.18	1.78 - 3.07
	Stainless Steel 300 Series 304, 316, 17-4PH, etc.	135 - 275	22 - 60	0.13 - 0.51	0.36 - 0.94	0.81 - 2.18	1.78 - 3.07
K	Grey Cast Iron, Ductile Iron, Spheroidal Cast Iron (Pearlitic)	< 200	22 - 90	0.13 - 0.51	0.36 - 0.94	0.81 - 2.18	1.78 - 3.07
	Spheroidal Cast Iron (Ferritic)	> 200	22 - 90	0.13 - 0.51	0.36 - 0.94	0.81 - 2.18	1.78 - 3.07
	Spheroidal Cast Iron (Ferritic)	260 - 320	22 - 90	0.13 - 0.51	0.36 - 0.94	0.81 - 2.18	1.78 - 3.07
N	Copper and Alloys Brass	< 500	45 - 105	0.13 - 0.51	0.36 - 0.94	0.81 - 2.18	1.78 - 3.07
	Bronze	< 180	45 - 105	0.13 - 0.51	0.36 - 0.94	0.81 - 2.18	1.78 - 3.07
	Bronze Phosphorous						
	Aluminum and Alloys	< 150	45 - 105	0.13 - 0.51	0.36 - 0.94	0.81 - 2.18	1.78 - 3.07

#### Max RPM

Series	Max RPM
H	2000
I	1500
K	1200
L	1000
F	1000
M	900
N	900
O	700
P	600
Q	500
R	300
S	300
T	250
U	200

**IMPORTANT:** The speeds and feeds listed on these pages are a general starting point for all applications. Factory technical assistance is available through our Application Engineering department.

**Stock Allowance | Metric (mm)**

Roller Burnishing

ISO	Material	Hardness (BHN)	Recommended Stock (mm) by Burnisher Diameter*			
			4.70 - 12.00	12.01 - 25.00	25.01 - 50.00	50.01 - 165.90
P	Free Machining Steel 1118, 1215, 12L14, etc.	100 - 180	0.010 - 0.018	0.018 - 0.041	0.025 - 0.046	0.030 - 0.051
		180 - 250	0.010 - 0.018	0.018 - 0.041	0.025 - 0.046	0.030 - 0.051
	Low Carbon Steel 1010, 1020, 1025, 1522, 1144, etc.	85 - 180	0.010 - 0.018	0.018 - 0.041	0.025 - 0.046	0.030 - 0.051
		180 - 275	0.010 - 0.018	0.018 - 0.041	0.025 - 0.046	0.030 - 0.051
	Medium Carbon Steel 1030, 1040, 1050, 1527, 1140, 1151, etc.	125 - 180	0.010 - 0.018	0.018 - 0.041	0.025 - 0.046	0.030 - 0.051
		180 - 325	0.010 - 0.018	0.012 - 0.018	0.012 - 0.025	0.020 - 0.036
	Alloy Steel 4140, 5140, 8640, etc.	125 - 180	0.010 - 0.018	0.018 - 0.041	0.025 - 0.046	0.030 - 0.051
		180 - 375	0.010 - 0.018	0.012 - 0.018	0.012 - 0.025	0.020 - 0.036
	High Strength Alloy 4340, 4330V, 300M, etc.	240 - 450	0.010 - 0.018	0.012 - 0.018	0.012 - 0.025	0.020 - 0.036
	Structural Steel A36, A285, A516, etc.	125 - 180	0.010 - 0.018	0.018 - 0.041	0.025 - 0.046	0.030 - 0.051
180 - 350		0.010 - 0.018	0.012 - 0.018	0.012 - 0.025	0.020 - 0.036	
Tool Steel H-13, H-21, A-4, O-2, S-3, etc.	150 - 200	0.010 - 0.018	0.018 - 0.041	0.025 - 0.046	0.030 - 0.051	
	200 - 250	0.010 - 0.018	0.012 - 0.018	0.012 - 0.025	0.020 - 0.036	
S	High Temp Alloy Hastelloy B, Inconel 600, etc.	140 - 310	0.010 - 0.018	0.012 - 0.018	0.012 - 0.025	0.020 - 0.036
	Titanium Alloy	140 - 310	0.010 - 0.018	0.012 - 0.018	0.012 - 0.025	0.020 - 0.036
M	Stainless Steel 400 Series 416, 420, etc.	135 - 350	0.010 - 0.018	0.018 - 0.041	0.025 - 0.046	0.030 - 0.051
	Stainless Steel 300 Series 304, 316, 17-4PH, etc.	135 - 275	0.010 - 0.018	0.018 - 0.041	0.025 - 0.046	0.030 - 0.051
K	Grey Cast Iron, Ductile Iron, Spheroidal Cast Iron (Pearlitic)	< 200	0.010 - 0.018	0.012 - 0.018	0.012 - 0.025	0.020 - 0.036
		> 200	0.010 - 0.018	0.012 - 0.018	0.012 - 0.025	0.020 - 0.036
	Spheroidal Cast Iron (Ferritic)	260 - 320	0.010 - 0.018	0.012 - 0.018	0.012 - 0.025	0.020 - 0.036
N	Copper and Alloys Brass	< 500	0.010 - 0.018	0.018 - 0.041	0.025 - 0.046	0.030 - 0.051
	Bronze	< 180	0.010 - 0.018	0.018 - 0.041	0.025 - 0.046	0.030 - 0.051
	Bronze Phosphorous	< 180	0.010 - 0.018	0.018 - 0.041	0.025 - 0.046	0.030 - 0.051
	Aluminum and Alloys	< 150	0.010 - 0.018	0.018 - 0.041	0.025 - 0.046	0.030 - 0.051

\*Stock value is on diameter.

A  
DRILLING  
B  
BORING  
C  
REAMING  
D  
BURNISHING  
E  
THREADING  
X  
SPECIALS









## Warranty Information



Allied Machine & Engineering ("Allied Machine") warrants to original equipment manufacturers, distributors, industrial and commercial users of its products for one year from the original date of sale that each new product manufactured or supplied by Allied Machine shall be free from defects in material and workmanship.

Allied Machine's sole and exclusive obligation under this warranty is limited to, at its option, without additional charge, replacing or repairing this product or issuing a credit. For this warranty to be applied, the product must be returned freight prepaid to the plant designated by an Allied Machine representative and which, upon inspection, is determined by Allied Machine to be defective in material and workmanship.

Complete information as to operating conditions, machine, setup, and the application of cutting fluid should accompany any product returned for inspection. This warranty shall not apply to any Allied Machine products which have been subjected to misuse, abuse, improper operating conditions, improper machine setup or improper application of cutting fluid or which have been repaired or altered if such repair or alteration, in the judgement of Allied Machine, would adversely affect the performance of the product.

THIS WARRANTY IS IN LIEU OF ALL OTHER WARRANTIES, EXPRESS OR IMPLIED, INCLUDING ANY IMPLIED WARRANTY OF MERCHANTABILITY OR FITNESS FOR A PARTICULAR PURPOSE. Allied Machine shall have no liability or responsibility for any claim, whether in contract, tort or otherwise, for any loss or damage arising out of, connected with, or resulting from the manufacture, sale, delivery or use of any product sold hereunder, in excess of the cost of replacement or repair as provided herein.

Allied Machine shall not be liable in contract or in tort (including, without limitation, negligence, strict liability or otherwise) for economic losses of any kind or for any special, incidental, indirect, consequential, punitive or exemplary damages arising in any way out of the performance of, or failure to perform this agreement.

ALL PRICES, DELIVERIES, DESIGNS, AND MATERIALS ARE SUBJECT TO CHANGE WITHOUT NOTICE.



Allied Machine & Engineering  
Registered to ISO 9001  
10001329

## Deutschland | Österreich | Schweiz

**Wohlhaupter GmbH**  
Maybachstraße 4  
72636 Frickenhausen  
Germany

**Telefon:**  
+49 (0) 7022 408-0  
**Email:**  
info@wohlhaupter.de  
**Web:**  
www.wohlhaupter.com

## Europa

**Allied Machine & Engineering Co. (Europe) Ltd.**  
93 Vantage Point  
Pensnett Estate  
Kingswinford  
West Midlands  
DY6 7FR England

**Telefon:**  
+44 (0) 1384 400900  
**Email:**  
enquiries.eu@alliedmachine.com  
**Web:**  
www.alliedmachine.com

## Vereinigte Staaten

**Allied Machine & Engineering**  
120 Deeds Drive  
Dover OH 44622  
United States

**Telefon:**  
+1 330 343 4283  
**Fax:**  
+1 330 602 3400

**Allied Machine & Engineering**  
485 W Third Street  
Dover OH 44622  
United States

**Telefon:**  
+1 330 343 4283  
**Fax:**  
+1 330 364 7666  
(Engineering Dept.)

## Asien

**Wohlhaupter India Pvt. Ltd.**  
B-23, 2nd Floor  
B Block Community Centre  
Janakpuri, New Delhi - 110058  
India

**Telefon:**  
+91 11 41827044



日易呼 机械

### GOLDEN CARBIDE PRECISION

Room 2101-2102, Gateway International Plaza, Building A, No.325,Tian Yao Qiao Road,Shanghai, China Zip: 200030

2/F, No. 40, Sec. 2, Tun Hwa S. Road, Daan Dist.,Taipei, Taiwan Zip:106

Shanghai: 86-21-3363-2088

Beijing: 86-10-8851-8900

Chengdu 86-28-8526-6681

Changchun: 86-431-8461-7085

Chongqing: 86-23-6757-3205

Bonded Wh: 86-21-5868-3075

Taipei: 886-2-2705-8448

Taichung: 886-4-24638159

Website: [www.goldencarbide.com](http://www.goldencarbide.com)

**www.wohlhaupter.com**

90200 06.2018

Printed in Germany · Technische Änderungen vorbehalten

Holemaking Solutions for Today's Manufacturing