



ALLIED MACHINE & ENGINEERING

Holemaking Solutions for Today's Manufacturing



Boring



Reaming



Burnishing



Threading

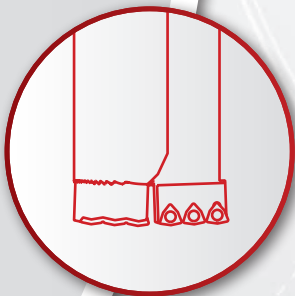

Specials



Revolution Drill[®]

► *DRILLING*

Indexable Insert Drilling System

North America

Allied Machine

120 Deeds Drive
Dover, OH 44622
United States

Allied Machine

485 West 3rd Street
Dover, OH 44622
United States

ThreadMills USA™

4185 Crosstowne Ct #B
Evans, GA 30809
United States

Superion™

1285 S Patton St.
Xenia, OH 45385
United States

Europe

Allied Machine Europe

93 Vantage Point
Pensnett Estate
Kingswinford
West Midlands
DY6 7FR, United Kingdom

Wohlhaupter® GmbH

Maybachstrasse 4
Postfach 1264
72636 Frickenhausen
Germany

Asia

Wohlhaupter® India

B-23, 2nd Floor
B Block Community Centre
Janakpuri, New Delhi - 110058
India



Allied Machine & Engineering is a worldwide leader in holemaking and finishing solutions. We are committed to providing practical and dependable solutions to our customers through innovative designs and superior customer and technical support.

We continue to expand our product offering in order to provide new and different solutions. With Field Sales Engineers located around the world, we position ourselves to provide technical support on site, right at your spindle.



ALLIED MACHINE
& ENGINEERING

www.alliedmachine.com



ALLIED MACHINE & ENGINEERING

Holemaking Solutions for Today's Manufacturing

Revolution Drill®

The Foundation

Since 1941, Allied Machine & Engineering has provided dependable and practical holemaking solutions to the world. What was once a small job shop in Ohio is now a worldwide leader in cutting tool technology. With three manufacturing facilities in Ohio, one in Georgia, another in Germany, and headquarters in both the United States and Europe, Allied Machine is positioned to bring innovative solutions and technical expertise directly to the customers' hands.



The Beginning

Harold E. Stokey founded Allied Machine & Engineering to aid the war effort, manufacturing taper bearing lock nuts for the production of M1 tanks. Years later, after a sales meeting gone wrong, Stokey possessed a warehouse stocked with spade drill inserts. He set forth into the industry that would become Allied Machine's thriving identity: holemaking.



The T-A®

When Harold's son, William H. Stokey, became the president and CEO, he developed the Throw Away, or T-A, spade drill insert system. The T-A revolutionized the holemaking industry, launching Allied Machine ahead of the competition. Since then, numerous innovations and advancements have been created from the T-A's inspiration.



The Innovation

Since the development of the T-A, Allied Machine has expanded its product offering to support a vast range of customer applications, including large diameter and deep hole drilling, boring, reaming, burnishing, porting, and threading.

The People

Allied Machine understands that high quality products are only one facet of success. Our customer support is crucial to what we do, and that's why we make sure the best engineers and customer service associates are in place to assist our customers around the world.

The Future

With over 75 years of experience, Allied Machine has encountered the challenges of growth and success. By investing in cutting edge technology and the brightest and sharpest minds, our knowledge and capabilities continue to expand and grow every day.



Steve Stokey
Executive Vice President

William H. Stokey
President and CEO

Mike Stokey
Executive Vice President



WOHLHAUPTER®



SUPERION™

CRITERION™

Replaceable Insert Drills

- Reduce costs by decreasing set-up time and utilizing a single holder for the lives of multiple inserts
- Provide flexibility to quickly switch between inserts with different geometries
- Products:
 - GEN3SYS® XT | GEN3SYS® XT Pro
 - Original T-A® | GEN2 T-A®
 - High Performance | Universal



Indexable Insert Drills

- Protect your investment and reduce your inventory with replaceable cartridges that allow the same holder to be used repeatedly
- Indexable inserts increase productivity and tool life while reducing costs
- Products:
 - 4TEX® Drill
 - Revolution Drill®
 - Opening Drill®



Replaceable / Indexable Insert Drills

- Allow for higher spindle speeds and take advantage of the power curve on modern CNC machines
- Achieve maximum penetration rates in deep hole drilling applications
- Holders cover a range of sizes with the replaceable heads determining the cutting diameter
- Products:
 - APX™ Drill



Solid Carbide Drills

- Offer greater strength and stability when drilling tougher materials
- Available in diameters from 3mm - 20mm
- Can be made-to-order specifically for your application (Superion™ quoted specials)
 - ASC 320®
 - Superion™



Structural Steel Solutions



- Deliver outstanding performance and durability in structural steel applications
- Designed to produce optimal results in difficult-to-machine materials
- Available in multiple lengths and diameters
- T-A® style drills have different insert geometry options to improve performance depending on material
- Products:
 - **Original T-A®** | **GEN2 T-A®**
 - **GEN3SYS® XT Pro**

BTA (STS) Machining Solutions

- The internal ejection system flushes chips and debris from the hole with no interference to the cutting process
- Utilizes the advantages of the T-A® drill insert
- Designed to significantly increase penetration rates over brazed heads and traditional gun drills
- Products:
 - **BT-A Drill**



Hydraulic Port Contour Cutters



- Save significant time and money by performing four processes in one step
- Replaceable insert design reduces costs, inventory, and set-up times
- Available in 4 industry specifications:
 - Imperial: SAE J-1926
 - Metric: ISO 6149-1:2006
 - Military: SAE AS5202
 - John Deere: JDS-G173.1
- Products:
 - **AccuPort 432®**



Enhanced Special Drilling Capabilities

- Allied Machine Engineers are available to meet with you to evaluate your application and recommend the best solution for you
- Special drilling solutions can incorporate advanced features such as adjustable diameter locations, multiple steps, additional coolant designs, special lengths and diameters, and more
- Special drills can drastically reduce your cost-per-hole and increase your overall productivity by eliminating multiple processes and increasing tool life



WOHLHAUPTER® High Precision Boring Systems

- Designs available for high volume applications that increase rigidity to improve performance
- Versatile boring heads that are flexible with changing applications while maintaining excellent performance
- Provides high precision with absolute repeatability to ensure every part is held to tolerance
- Offers an industry leading modular shank connection that maintains rigidity and reduces inventory on your boring system
- Available with both digital and analog settings
- Products:
 - Wohlhaupter® Boring Tools



CRITERION® Modular Boring Systems

- The modular capabilities are ideal for use across multiple different projects
- Offers versatile boring heads suitable for all job shops and tooling rooms
- Provides an economical solution for low volume and/or short-term production applications
- Offers both rough and finish boring solutions
- Products:
 - Criterion® Boring Tools

S.C.A.M.I.®

Expandable Reaming Solutions

- Expandable cutting diameters accommodate for wear, which extends tool life
- Replaceable cutting heads and rings reduce waste and improve production time versus solid high speed steel and carbide reamers
- Hold tight tolerances to ensure processes are performed to accurate specifications
- Reduce tooling costs because many items are available for recondition
- Products:
 - ALVAN® Reamers



S.C.A.M.I.®

Roller Burnishing Solutions

- Produce excellent surface finishes
- Provide accurate size control
- Increase surface hardness
- Solutions for both through hole and blind hole applications
- Products:
 - S.C.A.M.I.® Roller Burnishing Tools





Solid Carbide Thread Mills

- Available with coolant through options
- Cover a wide range of thread forms
- Provide optimal solutions for both high production projects and short-run applications
- Products
 - AccuThread™ 856
 - AccuThread™ T3
 - ThreadMills USA™



Replaceable Insert Thread Mills

- 3 insert lengths are available that cover a wide range of thread forms
- Holders can utilize inserts with different pitches and thread forms
- Repeatability is achieved by both the bolt-in style and the pin style locking systems
- Increase tool life by 25 - 50% with Allied Machine's AM210® coating
- Products
 - AccuThread™ 856: Bolt-in Style
 - AccuThread™ 856: Pin Style



SPECIAL CAPABILITIES

When it comes to designing and developing special solutions for customers, Allied Machine is the top choice. If your application requires special tooling, give us a call. Our engineered specials are developed by the brightest engineers in the industry. Most of our standard tooling can be altered as specials, or we can create entirely new concepts for particularly unique applications.

One special tooling solution is Insta-Quote®, the online system that allows you to design your own special tooling 24/7. Receive a quote and drawings within minutes just by following the steps.

And with the addition of Superior™ technology and capabilities, we can customize made-to-order solid carbide tools to achieve optimal results for your applications.

Whatever your application, Allied Machine has the answer.



Insta-Quote® 



 SUPERION™



ToolMD™

Increase the production and success of your applications today.

- Offers direct access to 2D drawings and 3D models
- Assemble and view tool images in your browser
- Download drawings for use in most machining software programs
- Browse products, search item numbers, and save assemblies for future use



toolmd.com

WOHLHAUPTER® Tool-Architect

Find the right Wohlhaupter® solution for your application.

- Configure your complete tool assembly
- Compile an order list to be quoted
- Search and quickly find components using various criteria
- Adjust your language and measurement preferences

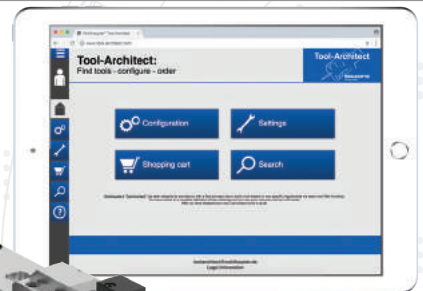

tool-architect.com

Insta-Quote®

Design your custom tooling and receive a drawing and quote...all within minutes.

- Design and quote your own tooling
- Guides you through steps to generate the solution you need
- Features the following products
 - T-A® Inserts
 - T-A® Holders
 - GEN3SYS® XT Holders
 - ALVAN® Reamers

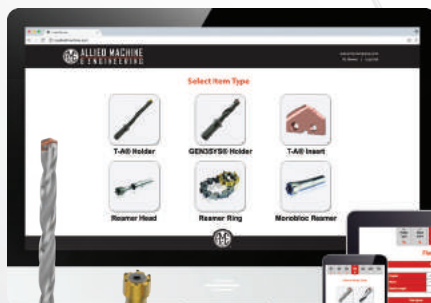

iq.alliedmachine.com

Insta-Code®

Eliminate the wait. Get your program now.

- Choose the best thread mill for your application
- Create program code for your machine
- Available as a PC download app (that can be used offline)
- Website app available 24/7



Insta-Code also has a
Cycle Time Calculator

alliedmachine.com/InstaCode

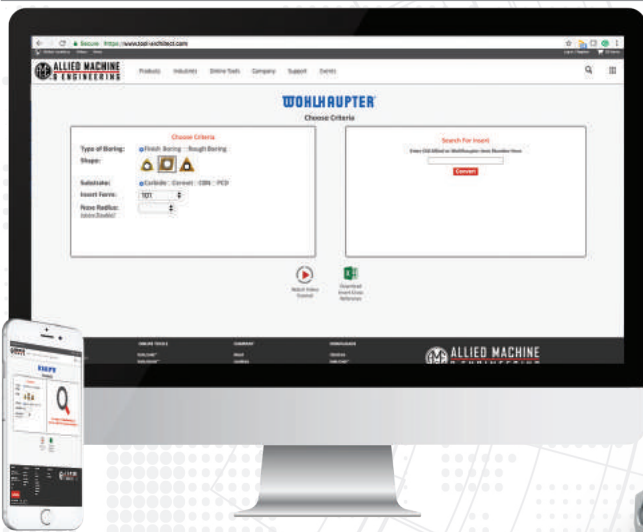

WOHLHAUPTER® Boring Insert Selector

Find the best insert for your application.

- Generate the correct boring insert for your job in just six easy steps
- Choose type, shape, substrate, insert form, nose radius, and material
- Easily order by adding the item to your cart

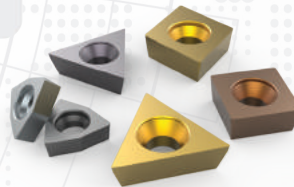

www.alliedmachine.com/bis

Product Selector

Use the product selector to find the right tool for your application.

- Guides you through steps to generate the right tool for your application
- Learn about your recommended tool and how to maximize its performance



www.alliedmachine.com/productselector

Machinist Tool App

Quickly convert cutting tool parameters for the machine inputs you need.

- Input data to calculate the RPM and speed and feed rates
- Also features the Boring Insert Selector
- Access product literature right at your fingertips

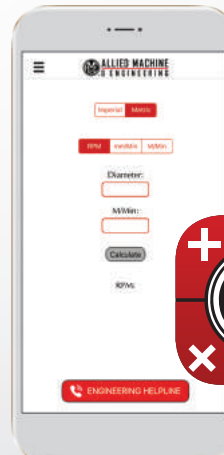

Revolution Drill®

Large Diameter Replaceable IC Insert Drilling System

► Diameter Range: 1.875" - 4.000" (47.6mm - 101.0mm)



Large Scale Innovation

The Revolution Drill has an innovative design that allows for adjustability of 0.200" (5.1mm) on diameter. This eliminates the need for special tooling and/or subsequent boring operations. With the ability to drill from solid, the Revolution Drill does not require a previously drilled pilot hole. The replaceable cartridges reduce set-up time, and the indexable inserts protect your investment. The insert design provides excellent chip control and aggressive penetration rates.

Drills from solid	Drill depths up to 4.5xD	Excellent chip control
-------------------	--------------------------	------------------------

Applicable Industries



Aerospace



Agriculture



Automotive



Firearms



General Machining



Oil & Gas



Renewable Energy

Your safety and the safety of others is very important. This catalog contains important safety messages. Always read and follow all safety precautions.



This triangle is a safety hazard symbol. It alerts you to potential safety hazards that can cause tool failure and serious injury.

When you see this symbol in the catalog, look for a related safety message that may be near this triangle or referred to in the nearby text.

There are safety signal words also used in the catalog. Safety messages follow these words.

WARNING

WARNING (shown above) means that failure to follow the precautions in this message could result in tool failure and serious injury.

NOTICE means that failure to follow the precautions in this message could result in damage to the tool or machine but not result in personal injury.

NOTE and **IMPORTANT** are also used. These are important that you read and follow but are not safety-related.

Visit www.alliedmachine.com for the most up-to-date information and procedures.

Reference Icons

The following icons will appear throughout the catalog to help you navigate between products.



Setup / Assembly Information

Detailed instructions and information regarding the corresponding part(s)

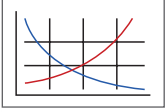

Recommended Cutting Data

Speed and feed recommendations for optimum and safe drilling

Series	Diameter Range	
	Imperial (inch)	Metric (mm)
34	1.875 - 2.000	47.6 - 50.8
36	2.000 - 2.200	50.8 - 55.9
38	2.200 - 2.400	55.9 - 61.0
42	2.400 - 2.600	61.0 - 66.0
44	2.600 - 2.800	66.0 - 71.1
46	2.800 - 3.000	71.1 - 76.2
48	3.000 - 3.200	76.2 - 81.3
52	3.200 - 3.400	81.3 - 86.4
54	3.400 - 3.600	86.4 - 91.4
56	3.600 - 3.800	91.4 - 96.5
58	3.800 - 4.000	96.5 - 101.6

Introduction Information

Product Overview 2 - 3
 Set-up Instructions 4
 Product Nomenclature 5

Drill Series

34 Series 6 - 7
 36 Series 8 - 9
 38 Series 10 - 11
 42 Series 12 - 13
 44 Series 14 - 15
 46 Series 16 - 17
 48 Series 18 - 19
 52 Series 20 - 21
 54 Series 22 - 23
 56 Series 24 - 25
 58 Series 26 - 27

Recommended Cutting Data

Imperial (inch) 28
 Metric (mm) 29

Product Overview

Series	Diameter Range		Length to Diameter Ratio	Shank Options			Inserts per Cartridge	Page
	Imperial (in)	Metric (mm)		Straight	CAT40	CAT50		
34	1.875 - 2.000	47.6 - 50.8	2.2, 3.5, 4.5	✓	✓	✓	2	6 - 7
36	2.000 - 2.200	50.8 - 55.9	2.2, 3.5, 4.5	✓	✓	✓	2	8 - 9
38	2.200 - 2.400	55.9 - 61.0	2.2, 3.5, 4.5	✓	✓	✓	2	10 - 11
42	2.400 - 2.600	61.0 - 66.0	2.2, 3.5, 4.5	✓	✓	✓	2	12 - 13
44	2.600 - 2.800	66.0 - 71.1	2.2, 3.5	✓		✓	3	14
46	2.800 - 3.000	71.1 - 76.2	2.2, 3.5	✓		✓	3	15
48	3.000 - 3.200	76.2 - 81.3	1.0, 2.5	✓		✓	3	16
52	3.200 - 3.400	81.3 - 86.4	1.0, 2.5	✓		✓	3	17
54	3.400 - 3.600	86.4 - 91.4	1.0, 2.5	✓		✓	3	18
56	3.600 - 3.800	91.4 - 96.5	1.0, 2.5	✓		✓	4	19
58	3.800 - 4.000	96.5 - 101.6	1.0, 2.5	✓		✓	4	20

NOTE: Stacked plate styles are also available

Features & Benefits

- Adjustability of 0.200" (5.1mm) on diameter
- Drill depths up to 4.5xD (standard)
- The replaceable cartridges protect your investment
- Adjustable diameter reduces inventory and cost
- The insert design allows for excellent chip control and aggressive penetration rates
- No pilot hole needed

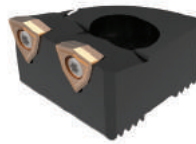

2 Inserts
(34 - 42 series)

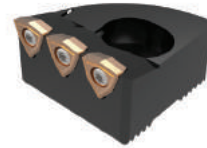

3 Inserts
(44 - 54 series)



4 Inserts
(56 - 58 series)

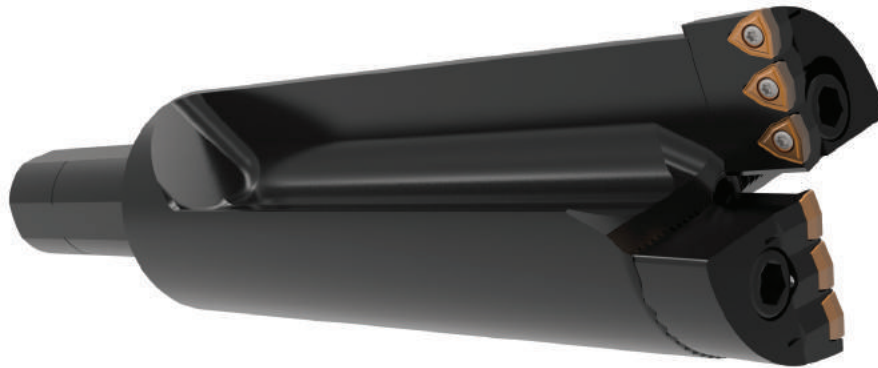

Shank Options



Straight Shank
(all series)



CAT40 Shank
(34, 36, 38, 42 series)



CAT50 Shank
(all series)

Body Lengths

- 1.0xD (48, 52, 54, 56, 58 series)
- 2.2xD (34, 36, 38, 42, 44, 46 series)
- 2.5xD (48, 52, 54, 56, 58 series)
- 3.5xD (34, 36, 38, 42, 44, 46 series)
- 4.5xD (34, 36, 38, 42, 44, 46 series)

A DRILLING
B BORING
C REAMING
D BURNISHING
E THREADING
X SPECIALS

Product Overview

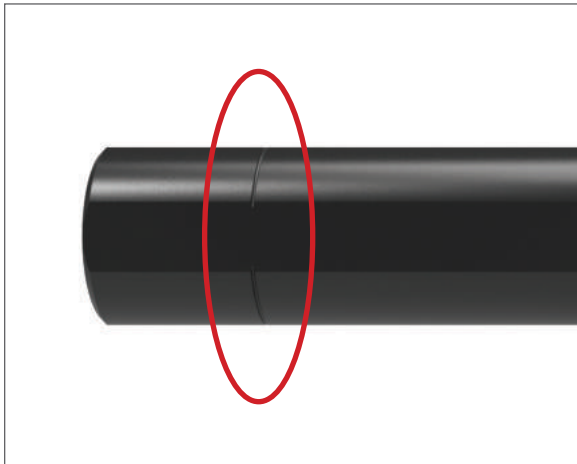
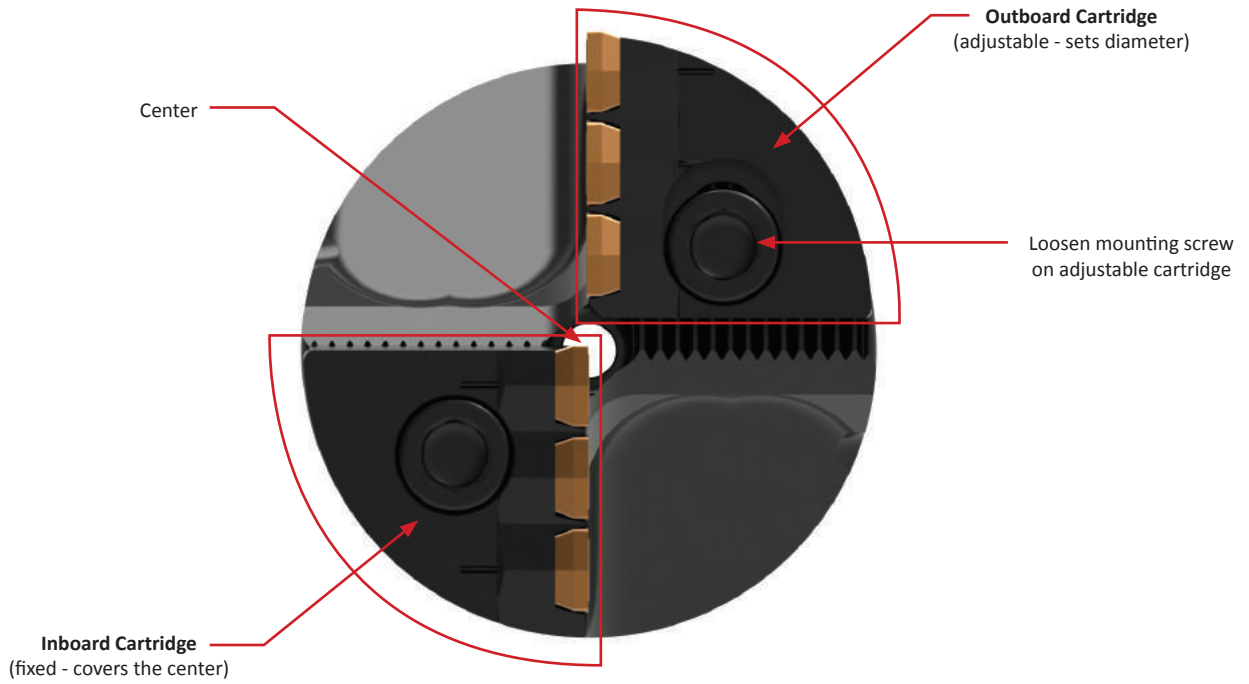

Straight Shanks

- Designed for lathe applications
- Can be cut off for use in end-mill holders
- The score mark (circled above) is provided for recommended cut length
- Cut and deburr at the score mark
- This improves rigidity when the body sits against the face of an end-mill holder



Set-up Instructions

A
DRILLING
B
BORING
C
REAMING
D
BURNISHING
E
THREADING
X
SPECIALS

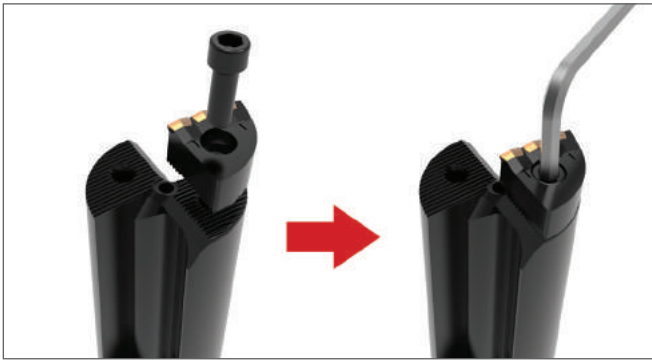

Step 1:
Mount the fixed cartridge and tighten the mounting screw to 11-14 ft-lbf (15-19 N-m).

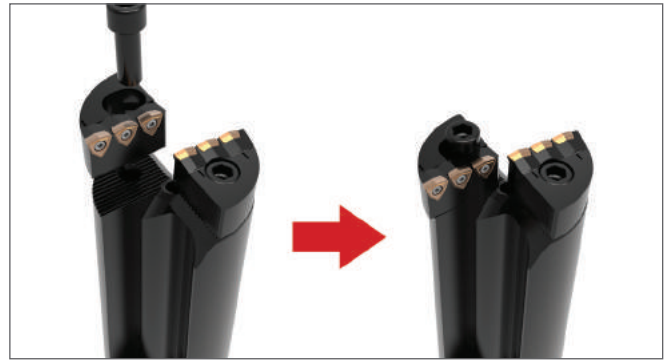

Step 2:
Finger-tighten the mounting screw on the adjustable cartridge.



Step 3:
Set the diameter using the adjustment screw against the mounting screw. Place the drill in a pre-setter to ensure the correct diameter setting.



Step 4:
Tighten the mounting screw to 11-14 ft-lbf (15-19 N-m).

IC Inserts

- The design allows for excellent chip control and aggressive penetration rates
- The proprietary AM200® and AM300® coatings increase tool life above competitors' premium coatings
- The same inserts are used for both Revolution Drill and Opening Drill products



AM300®



AM200®



TIN

Insert Application Recommendations

Carbide Grade Options

C5 (P35)	General purpose carbide grade suitable for most applications. ▶ <i>Common application in steels and stainless steels.</i>
C1 (K35)	Toughest carbide grade. Provides the best combination of edge strength and tool life. ▶ <i>Recommended for less rigid applications.</i>
C2 (K25)	Higher wear resistant carbide suitable for abrasive material applications. ▶ <i>Recommended for grey, ductile, and nodular irons.</i>

Additional Geometry Option

High Rake (HR)	Provides superior chip control and tool life in long chipping carbon and alloy steels below 200 Bhn.
----------------	--

Product Nomenclature

Revolution Drill Holders

R	34	X	22	-	150L
1	2		3		4

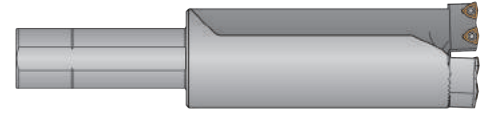

1. Drill Style	2. Series	3. Length to Diameter Ratio	4. Shank Information
R = Standard SP = Stacked Plate	34 = 34 series 44 = 44 series 54 = 54 series 36 = 36 series 46 = 46 series 56 = 56 series 38 = 38 series 48 = 48 series 58 = 58 series 42 = 42 series 52 = 52 series	10 = 1.0xD 22 = 2.2xD 25 = 2.5xD 35 = 3.5xD 45 = 4.5xD	150L = 1-1/2 Ø straight 200L = 2.0 Ø straight 40M = 40mm ISO 9766 50M = 50mm ISO 9766 CV40 = CAT40 CV50 = CAT50

Revolution Drill Inserts

OP	-	05	T3	08	-	1	H	HR
1		2	3	4		5	6	7

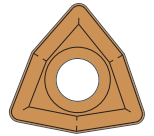

1. Compatible with:	2. IC Type	3. Thickness	4. Radius	5. Carbide Grade
Opening Drill Revolution Drill	05 = 5/16"	T3 = 5/32"	08 = 1/32"	Blank = C5 (P35) 1 = C1 (K35) 2 = C2 (K25)
6. Coating	7. Geometry			
P = AM300® H = AM200® T = TiN A = TiAlN N = TiCN U = Uncoated	Blank = General Purpose HR = High Rake			

Reference Key

Symbol	Attribute
D_1	Drill diameter range
D_2	Shank diameter
L_1	Overall length
L_2	Maximum drill depth
L_4	Holder length
L_7	Shank length
P_1	Rear pipe tap

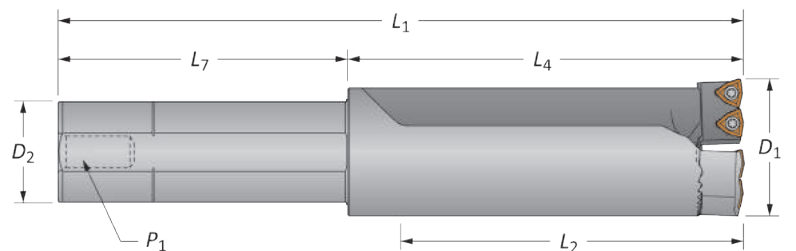



Revolution Drill Holders

34 Series | Diameter Range: 1.875" - 2.000" (47.6mm - 50.8mm)

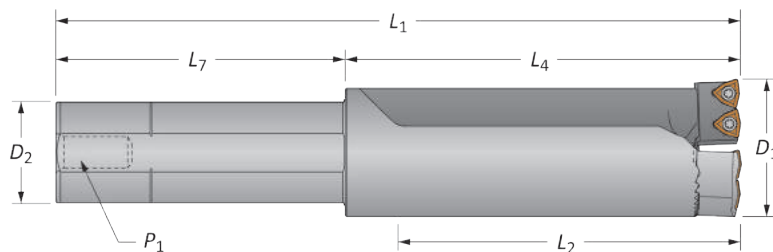

Straight Shank Imperial

Style	Length	D ₁ Range	Holder			Shank			Part No.*	Cartridges
			L ₂	L ₄	L ₁	D ₂	L ₇	P ₁		
Standard	2.2xD	1.875 - 2.000	4-17/32	5-13/32	9-13/32	1-1/2	4	1/4	R34X22-150L	C34-...
Standard	3.5xD	1.875 - 2.000	7-1/32	7-29/32	11-29/32	1-1/2	4	1/4	R34X35-150L	C34-...
Standard	4.5xD	1.875 - 2.000	9-1/32	9-29/32	13-29/32	1-1/2	4	1/4	R34X45-150L	C34-...
Stacked Plate	2.2xD	1.875 - 2.000	4-27/64	5-5/16	9-5/16	1-1/2	4	1/4	SP34X22-150L	C34SP-...

*Holder includes cartridges; however, inserts are sold separately.

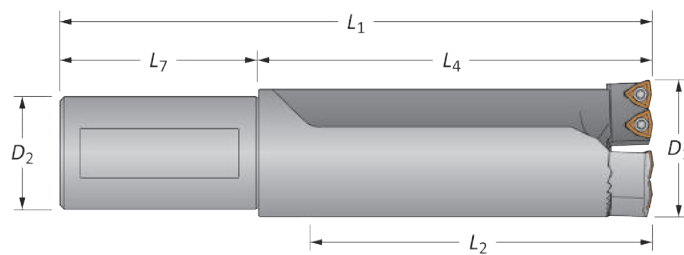

Straight Shank Metric

Style	Length	D ₁ Range	Holder			Shank			Part No.*	Cartridges
			L ₂	L ₄	L ₁	D ₂	L ₇	P ₁		
Standard	2.2xD	47.6 - 50.8	114.9	137.4	207.4	40	70	-	R34X22-40M	C34-...
Standard	3.5xD	47.6 - 50.8	178.4	200.9	270.9	40	70	-	R34X35-40M	C34-...
Standard	4.5xD	47.6 - 50.8	229.2	251.7	321.7	40	70	-	R34X45-40M	C34-...
Stacked Plate	2.2xD	47.6 - 50.8	112.4	134.8	204.8	40	70	-	SP34X22-40M	C34SP-...

*Holder includes cartridges; however, inserts are sold separately.

A60: 22 - 23

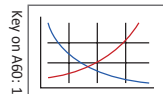

A60: 2 - 4



i = Imperial (in)
m = Metric (mm)



Revolution Drill Holders

34 Series | Diameter Range: 1.875" - 2.000" (47.6mm - 50.8mm)

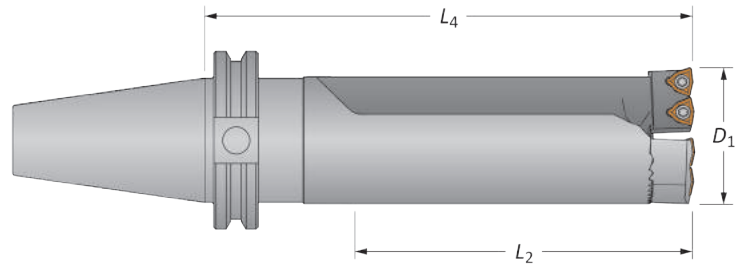

CV40 Shank

Style	Length	D ₁ Range	Holder		Shank	Part No.*	Cartridges
			L ₂	L ₄			
Standard	2.2xD	1.875 - 2.000	4-17/32	6-25/32	CV40	R34X22-CV40	C34-...
Standard	3.5xD	1.875 - 2.000	7-1/32	9-9/32	CV40	R34X35-CV40	C34-...
Standard	4.5xD	1.875 - 2.000	9-1/32	11-9/32	CV40	R34X45-CV40	C34-...
Stacked Plate	2.2xD	1.875 - 2.000	4-27/64	6-11/16	CV40	SP34X22-CV40	C34SP-...

*Holder includes cartridges; however, inserts are sold separately.

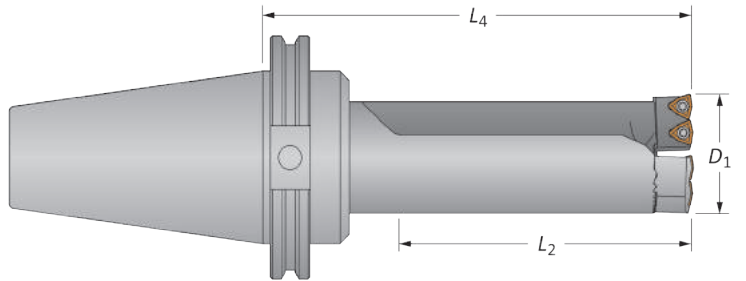

CV50 Shank

Style	Length	D ₁ Range	Holder		Shank	Part No.*	Cartridges
			L ₂	L ₄			
Standard	2.2xD	1.875 - 2.000	4-17/32	6-25/32	CV50	R34X22-CV50	C34-...
Standard	3.5xD	1.875 - 2.000	7-1/32	9-9/32	CV50	R34X35-CV50	C34-...
Standard	4.5xD	1.875 - 2.000	9-1/32	11-9/32	CV50	R34X45-CV50	C34-...
Stacked Plate	2.2xD	1.875 - 2.000	4-27/64	6-11/16	CV50	SP34X22-CV50	C34SP-...

*Holder includes cartridges; however, inserts are sold separately.

Cartridges

Holder Part No.	Replacement Cartridges	Qty. Inserts Needed	Mounting Screw	Key Size	Adjusting Screw	Driver
R34...	C34-FIX	2	MS-17M-1	5mm	AS-16T9-1	8T-9
	C34-ADJ	2	MS-17M-1	5mm	AS-16T9-1	8T-9
SP34...	C34SP-FIX	2	MS-17M-1	5mm	AS-16T9-1	8T-9
	C34SP-ADJ	2	MS-17M-1	5mm	AS-16T9-1	8T-9

IC Inserts

Carbide Grade	Geometry	Part No.			Insert Screws	Driver
		AM300®	AM200®	TiN		
C5 (P35)	Standard	OP-05T308-P	OP-05T308-H	OP-05T308-T	IS-10-1	8T-9
C1 (K35)	Standard	OP-05T308-1P	OP-05T308-1H	OP-05T308-1T	IS-10-1	8T-9
C2 (K25)	Standard	OP-05T308-2P	OP-05T308-2H	-	IS-10-1	8T-9
C5 (P35)	High Rake	OP-05T308-PHR	OP-05T308-HHR	-	IS-10-1	8T-9

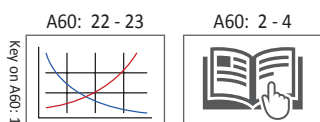

Mounting screws sold in multiples of 4 | Adjusting screws sold in multiples of 4
 IC inserts sold in multiples of 10 | Insert screws sold in multiples of 10

ⓘ = Imperial (in)
 ⓘ = Metric (mm)

A
DRILLING
B
BORING
C
REAMING
D
BURNISHING
E
THREADING
X
SPECIALS

Revolution Drill Holders

36 Series | Diameter Range: 2.000" - 2.200" (50.8mm - 55.9mm)

A
DRILLING

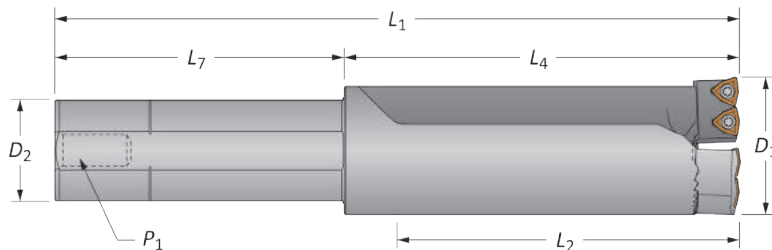

B
BORING

Straight Shank Imperial

Style	Length	D ₁ Range	Holder			Shank			Part No.*	Cartridges
			L ₂	L ₄	L ₁	D ₂	L ₇	P ₁		
Standard	2.2xD	2.000 - 2.200	4-61/64	5-57/64	9-57/64	1-1/2	4	1/4	R36X22-150L	C36-...
Standard	3.5xD	2.000 - 2.200	7-45/64	8-41/64	12-41/64	1-1/2	4	1/4	R36X35-150L	C36-...
Standard	4.5xD	2.000 - 2.200	9-61/64	10-57/64	14-57/64	1-1/2	4	1/4	R36X45-150L	C36-...
Stacked Plate	2.2xD	2.000 - 2.200	4-57/64	5-13/16	9-13/16	1-1/2	4	1/4	SP36X22-150L	C36SP-...

*Holder includes cartridges; however, inserts are sold separately.

C
REAMING

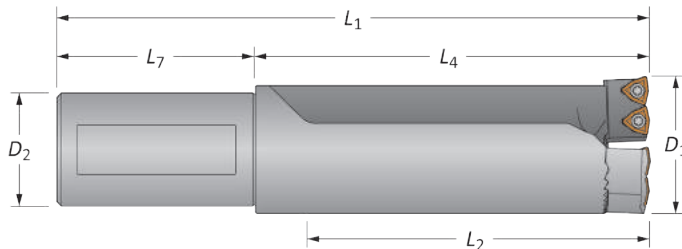

D
BURNISHING

Straight Shank Metric

Style	Length	D ₁ Range	Holder			Shank			Part No.*	Cartridges
			L ₂	L ₄	L ₁	D ₂	L ₇	P ₁		
Standard	2.2xD	50.8 - 55.9	126.0	149.6	219.6	40	70	-	R36X22-40M	C36-...
Standard	3.5xD	50.8 - 55.9	195.8	219.4	289.4	40	70	-	R36X35-40M	C36-...
Standard	4.5xD	50.8 - 55.9	253.0	276.6	346.6	40	70	-	R36X45-40M	C36-...
Stacked Plate	2.2xD	50.8 - 55.9	124.0	147.6	217.6	40	70	-	SP36X22-40M	C36SP-...

*Holder includes cartridges; however, inserts are sold separately.

F
THREADING

X
SPECIALS

A60: 22 - 23 Key on A60: 1

A60: 2 - 4

i = Imperial (in)
m = Metric (mm)



Revolution Drill Holders

36 Series | Diameter Range: 2.000" - 2.200" (50.8mm - 55.9mm)

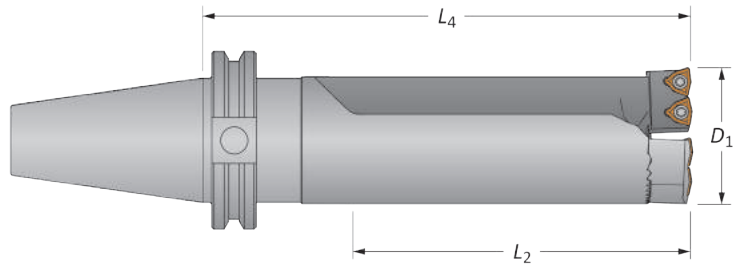

CV40 Shank

Style	Length	D ₁ Range	Holder		Shank	Part No.*	Cartridges
			L ₂	L ₄			
Standard	2.2xD	2.000 - 2.200	4-61/64	7-17/64	CV40	R36X22-CV40	C36-...
Standard	3.5xD	2.000 - 2.200	7-45/64	10-1/64	CV40	R36X35-CV40	C36-...
Standard	4.5xD	2.000 - 2.200	9-61/64	12-17/64	CV40	R36X45-CV40	C36-...
Stacked Plate	2.2xD	2.000 - 2.200	4-57/64	7-35/64	CV40	SP36X22-CV40	C36SP-...

*Holder includes cartridges; however, inserts are sold separately.

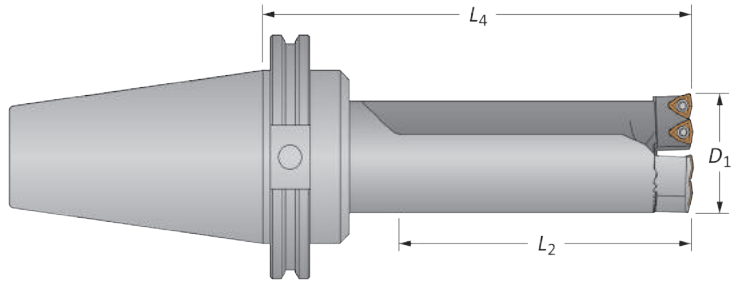

CV50 Shank

Style	Length	D ₁ Range	Holder		Shank	Part No.*	Cartridges
			L ₂	L ₄			
Standard	2.2xD	2.000 - 2.200	4-61/64	7-17/64	CV50	R36X22-CV50	C36-...
Standard	3.5xD	2.000 - 2.200	7-45/64	10-1/64	CV50	R36X35-CV50	C36-...
Standard	4.5xD	2.000 - 2.200	9-61/64	12-17/64	CV50	R36X45-CV50	C36-...
Stacked Plate	2.2xD	2.000 - 2.200	4-57/64	7-35/64	CV50	SP36X22-CV50	C36SP-...

*Holder includes cartridges; however, inserts are sold separately.

Cartridges

Holder Part No.	Replacement Cartridges	Qty. Inserts Needed	Mounting Screw	Key Size	Adjusting Screw	Driver
R36...	C36-FIX	2	MS-17M-1	5mm	AS-18T9-1	8T-9
	C36-ADJ	2	MS-17M-1	5mm	AS-18T9-1	8T-9
SP36...	C36SP-FIX	2	MS-17M-1	5mm	AS-18T9-1	8T-9
	C36SP-ADJ	2	MS-17M-1	5mm	AS-18T9-1	8T-9

IC Inserts

Carbide Grade	Geometry	Part No.			Insert Screws	Driver
		AM300®	AM200®	TiN		
C5 (P35)	Standard	OP-05T308-P	OP-05T308-H	OP-05T308-T	IS-10-1	8T-9
C1 (K35)	Standard	OP-05T308-1P	OP-05T308-1H	OP-05T308-1T	IS-10-1	8T-9
C2 (K25)	Standard	OP-05T308-2P	OP-05T308-2H	-	IS-10-1	8T-9
C5 (P35)	High Rake	OP-05T308-PHR	OP-05T308-HHR	-	IS-10-1	8T-9

A60: 22 - 23 A60: 2 - 4

Key on A60:

Mounting screws sold in multiples of 4 | Adjusting screws sold in multiples of 4
 IC inserts sold in multiples of 10 | Insert screws sold in multiples of 10

ⓘ = Imperial (in)
 Ⓜ = Metric (mm)



Revolution Drill Holders

38 Series | Diameter Range: 2.200" - 2.400" (55.9mm - 61.0mm)

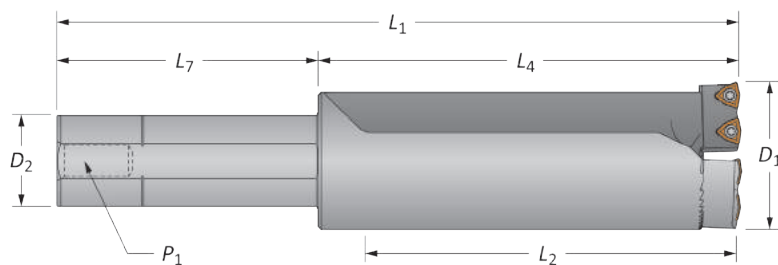

Straight Shank Imperial

Style	Length	D ₁ Range	Holder			Shank			Part No.*	Cartridges
			L ₂	L ₄	L ₁	D ₂	L ₇	P ₁		
Standard	2.2xD	2.200 - 2.400	5-29/64	6-25/64	10-25/64	1-1/2	4	1/4	R38X22-150L	C38-...
Standard	3.5xD	2.200 - 2.400	8-29/64	9-25/64	13-25/64	1-1/2	4	1/4	R38X35-150L	C38-...
Standard	4.5xD	2.200 - 2.400	10-61/64	11-57/64	15-57/64	1-1/2	4	1/4	R38X45-150L	C38-...
Stacked Plate	2.2xD	2.200 - 2.400	5-3/8	6-19/64	10-19/64	1-1/2	4	1/4	SP38X22-150L	C38SP-...

*Holder includes cartridges; however, inserts are sold separately.

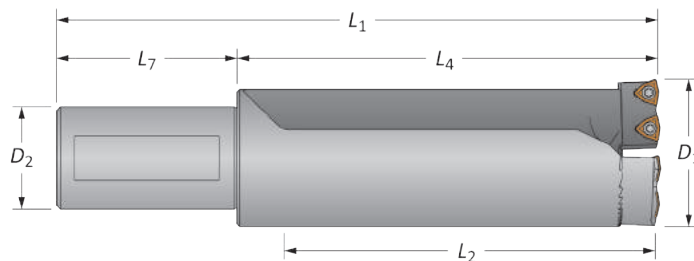

Straight Shank Metric

Style	Length	D ₁ Range	Holder			Shank			Part No.*	Cartridges
			L ₂	L ₄	L ₁	D ₂	L ₇	P ₁		
Standard	2.2xD	55.9 - 61.0	138.7	162.2	232.2	40	70	-	R38X22-40M	C38-...
Standard	3.5xD	55.9 - 61.0	214.9	238.4	308.4	40	70	-	R38X35-40M	C38-...
Standard	4.5xD	55.9 - 61.0	278.4	301.9	371.9	40	70	-	R38X45-40M	C38-...
Stacked Plate	2.2xD	55.9 - 61.0	136.5	160.0	230.0	40	70	-	SP38X22-40M	C38SP-...

*Holder includes cartridges; however, inserts are sold separately.

A60: 22 - 23

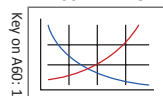

A60: 2 - 4



i = Imperial (in)
m = Metric (mm)



Revolution Drill Holders

38 Series | Diameter Range: 2.200" - 2.400" (55.9mm - 61.0mm)

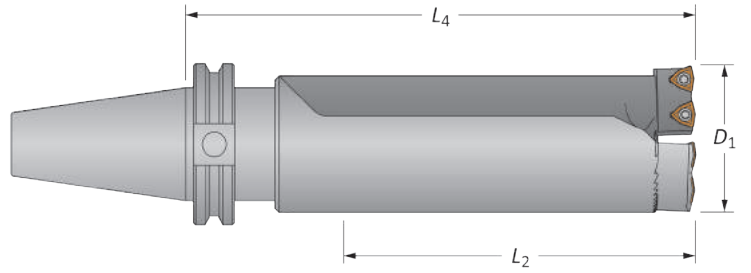

CV40 Shank

Style	Length	D ₁ Range	Holder		Shank	Part No.*	Cartridges
			L ₂	L ₄			
Standard	2.2xD	2.200 - 2.400	5-29/64	7-49/64	CV40	R38X22-CV40	C38-...
Standard	3.5xD	2.200 - 2.400	8-29/64	10-49/64	CV40	R38X35-CV40	C38-...
Standard	4.5xD	2.200 - 2.400	10-61/64	13-17/64	CV40	R38X45-CV40	C38-...
Stacked Plate	2.2xD	2.200 - 2.400	5-3/8	7-43/64	CV40	SP38X22-CV40	C38SP-...

*Holder includes cartridges; however, inserts are sold separately.

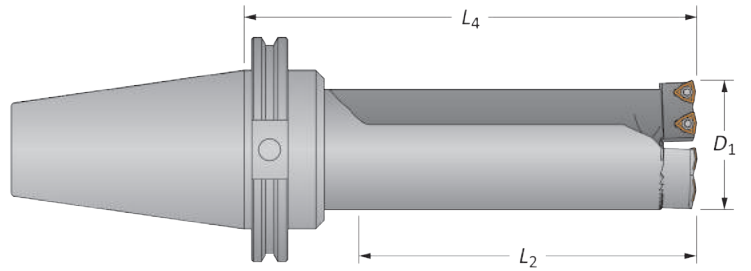

CV50 Shank

Style	Length	D ₁ Range	Holder		Shank	Part No.*	Cartridges
			L ₂	L ₄			
Standard	2.2xD	2.200 - 2.400	5-29/64	7-49/64	CV50	R38X22-CV50	C38-...
Standard	3.5xD	2.200 - 2.400	8-29/64	10-49/64	CV50	R38X35-CV50	C38-...
Standard	4.5xD	2.200 - 2.400	10-61/64	13-17/64	CV50	R38X45-CV50	C38-...
Stacked Plate	2.2xD	2.200 - 2.400	5-3/8	7-43/64	CV50	SP38X22-CV50	C38SP-...



*Holder includes cartridges; however, inserts are sold separately.

Cartridges

Holder Part No.	Replacement Cartridges	Qty. Inserts Needed	Mounting Screw	Key Size	Adjusting Screw	Driver
R38...	C38-FIX	2	MS-17M-1	5mm	AS-18T9-1	8T-9
	C38-ADJ	2	MS-17M-1	5mm	AS-18T9-1	8T-9
SP38...	C38SP-FIX	2	MS-17M-1	5mm	AS-18T9-1	8T-9
	C38SP-ADJ	2	MS-17M-1	5mm	AS-18T9-1	8T-9

IC Inserts

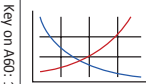
Carbide Grade	Geometry	Part No.			Insert Screws	Driver
		AM300®	AM200®	TiN		
C5 (P35)	Standard	OP-05T308-P	OP-05T308-H	OP-05T308-T	IS-10-1	8T-9
C1 (K35)	Standard	OP-05T308-1P	OP-05T308-1H	OP-05T308-1T	IS-10-1	8T-9
C2 (K25)	Standard	OP-05T308-2P	OP-05T308-2H	-	IS-10-1	8T-9
C5 (P35)	High Rake	OP-05T308-PHR	OP-05T308-HHR	-	IS-10-1	8T-9

A60: 22 - 23  A60: 2 - 4 

Mounting screws sold in multiples of 4 | Adjusting screws sold in multiples of 4
 IC inserts sold in multiples of 10 | Insert screws sold in multiples of 10

i = Imperial (in)
m = Metric (mm)



Revolution Drill Holders

42 Series | Diameter Range: 2.400" - 2.600" (61.0mm - 66.0mm)

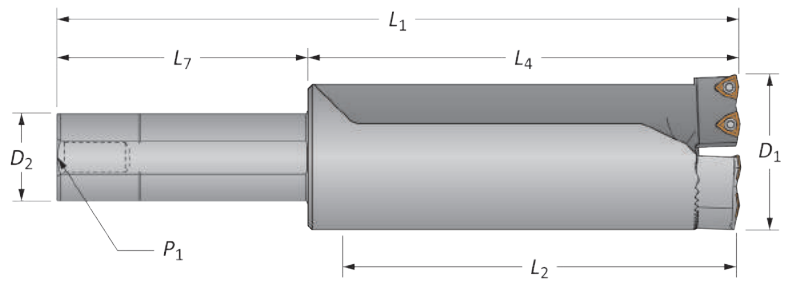

Straight Shank Imperial

Style	Length	D ₁ Range	Holder			Shank			Part No.*	Cartridges
			L ₂	L ₄	L ₁	D ₂	L ₇	P ₁		
Standard	2.2xD	2.400 - 2.600	5-45/64	6-49/64	10-49/64	1-1/2	4	1/4	R42X22-150L	C42-...
Standard	3.5xD	2.400 - 2.600	9-13/64	10-17/64	14-17/64	1-1/2	4	1/4	R42X35-150L	C42-...
Standard	4.5xD	2.400 - 2.600	11-45/64	12-49/64	16-49/64	1-1/2	4	1/4	R42X45-150L	C42-...
Stacked Plate	2.2xD	2.400 - 2.600	5-3/4	6-13/16	10-13/16	1-1/2	4	1/4	SP42X22-150L	C42SP-...

*Holder includes cartridges; however, inserts are sold separately.

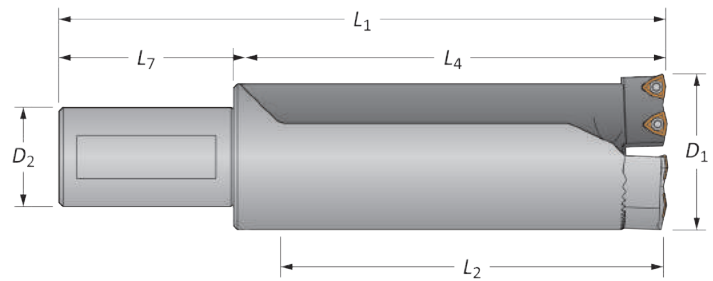

Straight Shank Metric

Style	Length	D ₁ Range	Holder			Shank			Part No.*	Cartridges
			L ₂	L ₄	L ₁	D ₂	L ₇	P ₁		
Standard	2.2xD	61.0 - 66.0	144.9	171.7	241.7	40	70	-	R42X22-40M	C42-...
Standard	3.5xD	61.0 - 66.0	233.8	260.6	330.6	40	70	-	R42X35-40M	C42-...
Standard	4.5xD	61.0 - 66.0	297.3	324.1	394.1	40	70	-	R42X45-40M	C42-...
Stacked Plate	2.2xD	61.0 - 66.0	146.1	172.9	242.9	40	70	-	SP42X22-40M	C42SP-...

*Holder includes cartridges; however, inserts are sold separately.

A60: 22 - 23

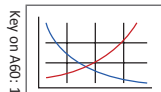

A60: 2 - 4



i = Imperial (in)
m = Metric (mm)



Revolution Drill Holders

42 Series | Diameter Range: 2.400" - 2.600" (61.0mm - 66.0mm)

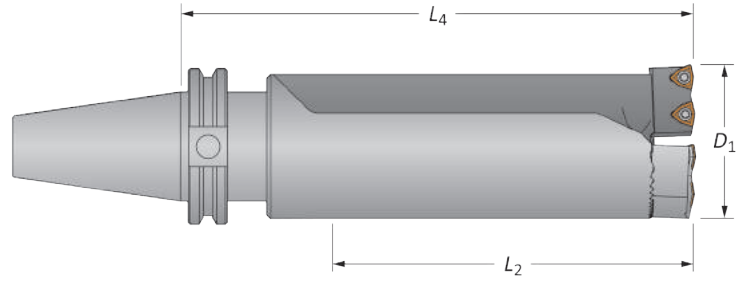

CV40 Shank

Style	Length	D ₁ Range	Holder		Shank	Part No.*	Cartridges
			L ₂	L ₄			
Standard	2.2xD	2.400 - 2.600	5-45/64	8-9/64	CV40	R42X22-CV40	C42-...
Standard	3.5xD	2.400 - 2.600	9-13/64	11-41/64	CV40	R42X35-CV40	C42-...
Standard	4.5xD	2.400 - 2.600	11-45/64	14-9/64	CV40	R42X45-CV40	C42-...
Stacked Plate	2.2xD	2.400 - 2.600	5-3/4	8-3/16	CV40	SP42X22-CV40	C42SP-...

*Holder includes cartridges; however, inserts are sold separately.

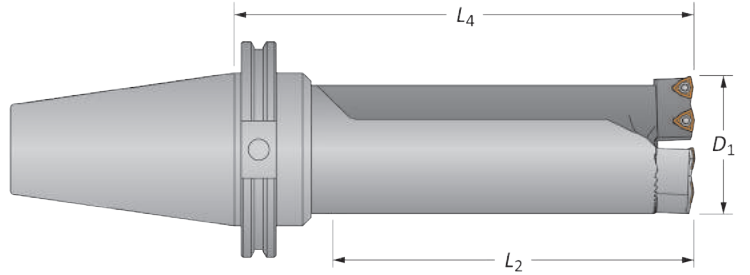

CV50 Shank

Style	Length	D ₁ Range	Holder		Shank	Part No.*	Cartridges
			L ₂	L ₄			
Standard	2.2xD	2.400 - 2.600	5-45/64	8-9/64	CV50	R42X22-CV50	C42-...
Standard	3.5xD	2.400 - 2.600	9-13/64	11-41/64	CV50	R42X35-CV50	C42-...
Standard	4.5xD	2.400 - 2.600	11-45/64	14-9/64	CV50	R42X45-CV50	C42-...
Stacked Plate	2.2xD	2.400 - 2.600	5-3/4	8-3/16	CV50	SP42X22-CV50	C42SP-...

*Holder includes cartridges; however, inserts are sold separately.

Cartridges

Holder Part No.	Replacement Cartridges	Qty. Inserts Needed	Mounting Screw	Key Size	Adjusting Screw	Driver
R42...	C42-FIX	2	MS-19M-1	6mm	AS-18T9-1	8T-9
	C42-ADJ	2	MS-19M-1	6mm	AS-18T9-1	8T-9
SP42...	C42SP-FIX	2	MS-19M-1	6mm	AS-18T9-1	8T-9
	C42SP-ADJ	2	MS-19M-1	6mm	AS-18T9-1	8T-9

IC Inserts

Carbide Grade	Geometry	Part No.			Insert Screws	Driver
		AM300®	AM200®	TiN		
C5 (P35)	Standard	OP-05T308-P	OP-05T308-H	OP-05T308-T	IS-10-1	8T-9
C1 (K35)	Standard	OP-05T308-1P	OP-05T308-1H	OP-05T308-1T	IS-10-1	8T-9
C2 (K25)	Standard	OP-05T308-2P	OP-05T308-2H	-	IS-10-1	8T-9
C5 (P35)	High Rake	OP-05T308-PHR	OP-05T308-HHR	-	IS-10-1	8T-9

A60: 22 - 23

A60: 2 - 4

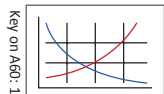

Mounting screws sold in multiples of 4 | Adjusting screws sold in multiples of 4
 IC inserts sold in multiples of 10 | Insert screws sold in multiples of 10

ⓘ = Imperial (in)
 Ⓜ = Metric (mm)

Revolution Drill Holders

44 Series | Diameter Range: 2.600" - 2.800" (66.0mm - 71.1mm)

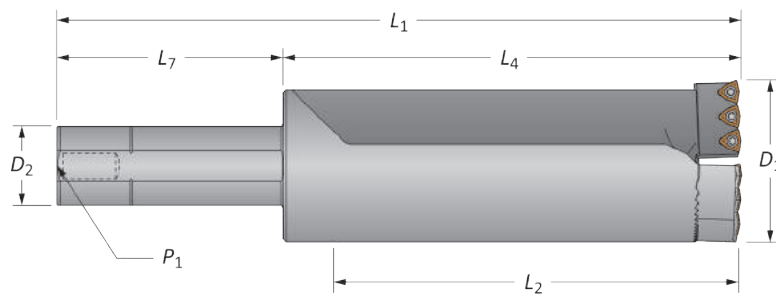

Straight Shank Imperial

Style	Length	D ₁ Range	Holder			Shank			Part No.*	Cartridges
			L ₂	L ₄	L ₁	D ₂	L ₇	P ₁		
Standard	2.2xD	2.600 - 2.800	6-13/64	7-1/2	11-1/2	1-1/2	4	1/4	R44X22-150L	C44-...
Standard	3.5xD	2.600 - 2.800	9-61/64	11-1/4	15-1/4	1-1/2	4	1/4	R44X35-150L	C44-...
Stacked Plate	2.2xD	2.600 - 2.800	6-1/4	7-35/64	11-35/64	1-1/2	4	1/4	SP44X22-150L	C44SP-...

*Holder includes cartridges; however, inserts are sold separately.

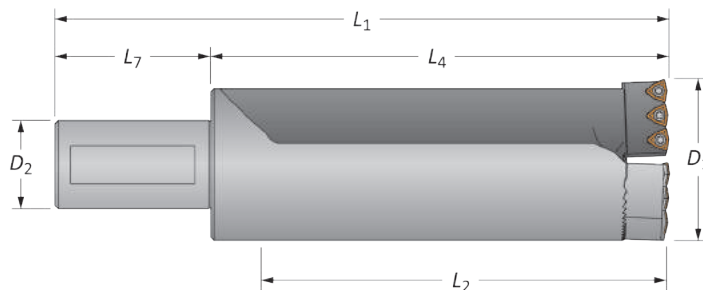

Straight Shank Metric

Style	Length	D ₁ Range	Holder			Shank			Part No.*	Cartridges
			L ₂	L ₄	L ₁	D ₂	L ₇	P ₁		
Standard	2.2xD	66.0 - 71.1	157.6	190.7	260.7	40	70	-	R44X22-40M	C44-...
Standard	3.5xD	66.0 - 71.1	252.9	285.9	355.9	40	70	-	R44X35-40M	C44-...
Stacked Plate	2.2xD	66.0 - 71.1	158.7	191.7	261.7	40	70	-	SP44X22-40M	C44SP-...

*Holder includes cartridges; however, inserts are sold separately.

A60: 22 - 23

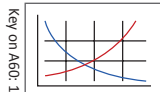

A60: 2 - 4



i = Imperial (in)
m = Metric (mm)



Revolution Drill Holders

44 Series | Diameter Range: 2.600" - 2.800" (66.0mm - 71.1mm)

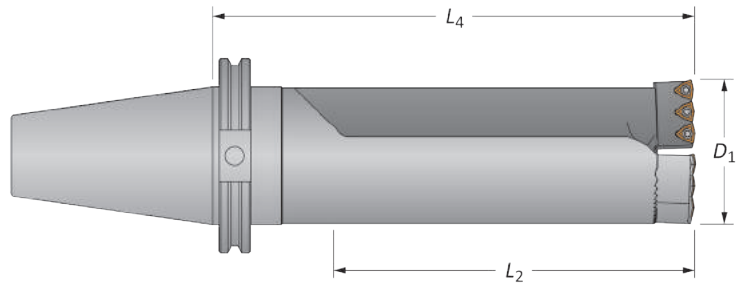

CV50 Shank

Style	Length	D ₁ Range	Holder		Shank	Part No.*	Cartridges
			L ₂	L ₄			
Standard	2.2xD	2.600 - 2.800	6-13/64	8-7/8	CV50	R44X22-CV50	C44-...
Standard	3.5xD	2.600 - 2.800	9-61/64	12-5/8	CV50	R44X35-CV50	C44-...
Stacked Plate	2.2xD	2.600 - 2.800	6-1/4	8-59/64	CV50	SP44X22-CV50	C44SP-...

*Holder includes cartridges; however, inserts are sold separately.

Cartridges

Holder Part No.	Replacement Cartridges	Qty. Inserts Needed	Mounting Screw	Key Size	Adjusting Screw	Driver
R44...	C44-FIX	3	MS-19M-1	6mm	AS-18T9-1	8T-9
	C44-ADJ	3	MS-19M-1	6mm	AS-18T9-1	8T-9
SP44...	C44SP-FIX	3	MS-19M-1	6mm	AS-18T9-1	8T-9
	C44SP-ADJ	3	MS-19M-1	6mm	AS-18T9-1	8T-9

IC Inserts

Carbide Grade	Geometry	Part No.			Insert Screws	Driver
		AM300®	AM200®	TiN		
C5 (P35)	Standard	OP-05T308-P	OP-05T308-H	OP-05T308-T	IS-10-1	8T-9
C1 (K35)	Standard	OP-05T308-1P	OP-05T308-1H	OP-05T308-1T	IS-10-1	8T-9
C2 (K25)	Standard	OP-05T308-2P	OP-05T308-2H	-	IS-10-1	8T-9
C5 (P35)	High Rake	OP-05T308-PHR	OP-05T308-HHR	-	IS-10-1	8T-9

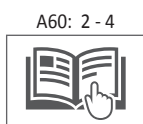
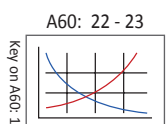

Mounting screws sold in multiples of 4 | Adjusting screws sold in multiples of 4
 IC inserts sold in multiples of 10 | Insert screws sold in multiples of 10

i = Imperial (in)
m = Metric (mm)

Revolution Drill Holders

46 Series | Diameter Range: 2.800" - 3.000" (71.1mm - 76.2mm)

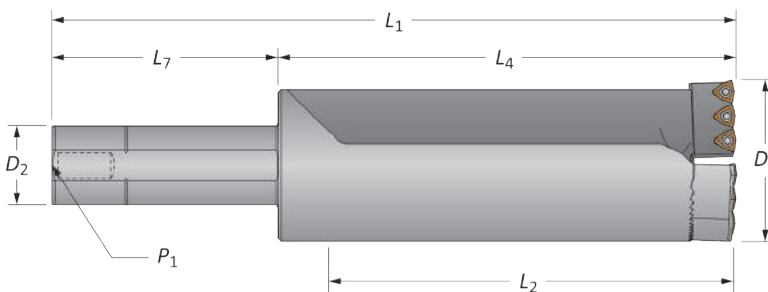

Straight Shank Imperial

Style	Length	D ₁ Range	Holder			Shank			Part No.*	Cartridges
			L ₂	L ₄	L ₁	D ₂	L ₇	P ₁		
Standard	2.2xD	2.800 - 3.000	6-45/64	8	12	1-1/2	4	1/4	R46X22-150L	C46-...
Standard	3.5xD	2.800 - 3.000	10-29/64	11-3/4	15-3/4	1-1/2	4	1/4	R46X35-150L	C46-...
Stacked Plate	2.2xD	2.800 - 3.000	6-3/4	8-3/64	12-3/64	1-1/2	4	1/4	SP46X22-150L	C46SP-...

*Holder includes cartridges; however, inserts are sold separately.

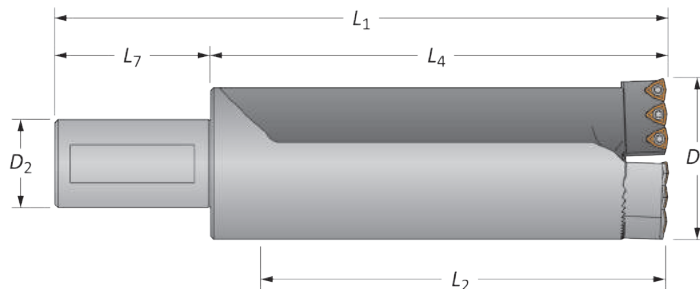

Straight Shank Metric

Style	Length	D ₁ Range	Holder			Shank			Part No.*	Cartridges
			L ₂	L ₄	L ₁	D ₂	L ₇	P ₁		
Standard	2.2xD	71.1 - 76.2	170.4	203.4	273.4	40	70	-	R46X22-40M	C46-...
Standard	3.5xD	71.1 - 76.2	265.6	298.6	368.6	40	70	-	R46X35-40M	C46-...
Stacked Plate	2.2xD	71.1 - 76.2	171.4	204.4	274.4	40	70	-	SP46X22-40M	C46SP-...

*Holder includes cartridges; however, inserts are sold separately.

A60: 22 - 23

A60: 2 - 4

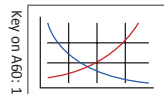

i = Imperial (in)
m = Metric (mm)



Revolution Drill Holders

46 Series | Diameter Range: 2.800" - 3.000" (71.1mm - 76.2mm)

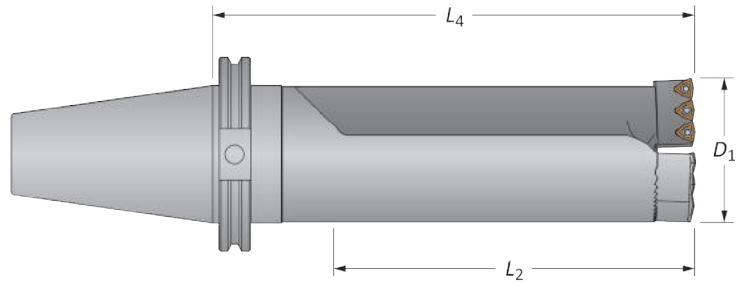

CV50 Shank

Style	Length	D ₁ Range	Holder		Shank	Part No.*	Cartridges
			L ₂	L ₄			
Standard	2.2xD	2.800 - 3.000	6-45/64	9-25/64	CV50	R46X22-CV50	C46-...
Standard	3.5xD	2.800 - 3.000	10-29/64	13-1/8	CV50	R46X35-CV50	C46-...
Stacked Plate	2.2xD	2.800 - 3.000	6-3/4	9-27/64	CV50	SP46X22-CV50	C46SP-...

*Holder includes cartridges; however, inserts are sold separately.

Cartridges

Holder Part No.	Replacement Cartridges	Qty. Inserts Needed	Mounting Screw	Key Size	Adjusting Screw	Driver
R46...	C46-FIX	3	MS-21M-1	8mm	AS-18T9-1	8T-9
	C46-ADJ	3	MS-21M-1	8mm	AS-18T9-1	8T-9
SP46...	C46SP-FIX	3	MS-21M-1	8mm	AS-18T9-1	8T-9
	C46SP-ADJ	3	MS-21M-1	8mm	AS-18T9-1	8T-9

IC Inserts

Carbide Grade	Geometry	Part No.			Insert Screws	Driver
		AM300®	AM200®	TiN		
C5 (P35)	Standard	OP-05T308-P	OP-05T308-H	OP-05T308-T	IS-10-1	8T-9
C1 (K35)	Standard	OP-05T308-1P	OP-05T308-1H	OP-05T308-1T	IS-10-1	8T-9
C2 (K25)	Standard	OP-05T308-2P	OP-05T308-2H	-	IS-10-1	8T-9
C5 (P35)	High Rake	OP-05T308-PHR	OP-05T308-HHR	-	IS-10-1	8T-9

A60: 22 - 23

A60: 2 - 4

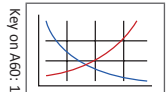

Mounting screws sold in multiples of 4 | Adjusting screws sold in multiples of 4
 IC inserts sold in multiples of 10 | Insert screws sold in multiples of 10

i = Imperial (in)
m = Metric (mm)



Revolution Drill Holders

48 Series | Diameter Range: 3.000" - 3.200" (76.2mm - 81.3mm)

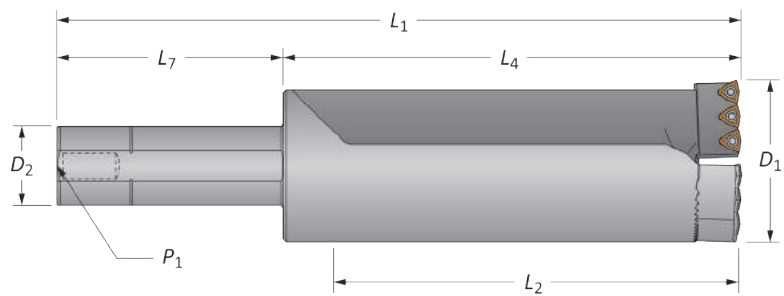

Straight Shank Imperial

Style	Length	D_1 Range	Holder			Shank			Part No.*	Cartridges
			L_2	L_4	L_1	D_2	L_7	P_1		
Standard	1.0xD	3.000 - 3.200	3-5/32	4-33/64	9-1/64	2	4-1/2	1/4	R48X10-200L	C48-...
Standard	2.5xD	3.000 - 3.200	7-29/32	9-17/64	13-49/64	2	4-1/2	1/4	R48X25-200L	C48-...
Stacked Plate	1.0xD	3.000 - 3.200	3-15/64	4-19/32	9-3/32	2	4-1/2	1/4	SP48X10-200L	C48SP-...
Stacked Plate	2.5xD	3.000 - 3.200	7-63/64	9-11/32	13-27/32	2	4-1/2	1/4	SP48X25-200L	C48SP-...

*Holder includes cartridges; however, inserts are sold separately.

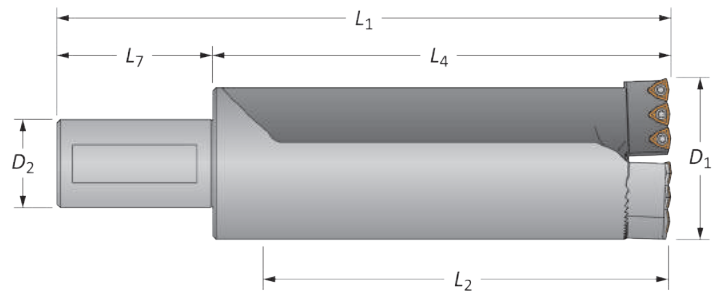

Straight Shank Metric

Style	Length	D_1 Range	Holder			Shank			Part No.*	Cartridges
			L_2	L_4	L_1	D_2	L_7	P_1		
Standard	1.0xD	76.2 - 81.3	80.2	114.5	194.5	50	80	-	R48X10-50M	C48-...
Standard	2.5xD	76.2 - 81.3	200.9	235.2	315.2	50	80	-	R48X25-50M	C48-...
Stacked Plate	1.0xD	76.2 - 81.3	82.2	116.5	196.5	50	80	-	SP48X10-50M	C48SP-...
Stacked Plate	2.5xD	76.2 - 81.3	202.9	237.2	317.2	50	80	-	SP48X25-50M	C48SP-...

*Holder includes cartridges; however, inserts are sold separately.

A60: 22 - 23

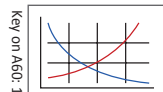

A60: 2 - 4



i = Imperial (in)
m = Metric (mm)



Revolution Drill Holders

48 Series | Diameter Range: 3.000" - 3.200" (76.2mm - 81.3mm)

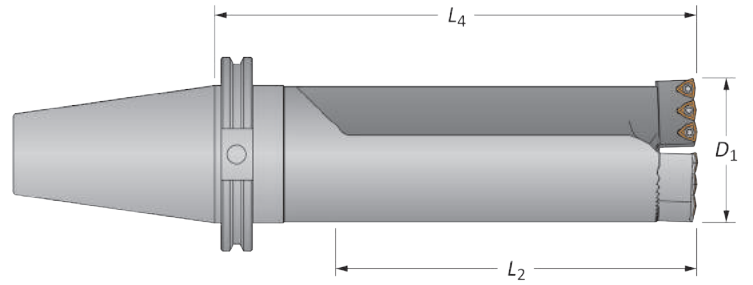

CV50 Shank

Style	Length	D ₁ Range	Holder		Shank	Part No.*	Cartridges
			L ₂	L ₄			
Standard	1.0xD	3.000 - 3.200	3-5/32	5-57/64	CV50	R48X10-CV50	C48-...
Standard	2.5xD	3.000 - 3.200	7-29/32	10-41/64	CV50	R48X25-CV50	C48-...
Stacked Plate	1.0xD	3.000 - 3.200	3-15/64	5-31/32	CV50	SP48X10-CV50	C48SP-...
Stacked Plate	2.5xD	3.000 - 3.200	7-63/64	10-23/32	CV50	SP48X25-CV50	C48SP-...

*Holder includes cartridges; however, inserts are sold separately.

Cartridges

Holder Part No.	Replacement Cartridges	Qty. Inserts Needed	Mounting Screw	Key Size	Adjusting Screw	Driver
R48...	C48-FIX	3	MS-21M-1	8mm	AS-18T9-1	8T-9
	C48-ADJ	3	MS-21M-1	8mm	AS-18T9-1	8T-9
SP48...	C48SP-FIX	3	MS-21M-1	8mm	AS-18T9-1	8T-9
	C48SP-ADJ	3	MS-21M-1	8mm	AS-18T9-1	8T-9

IC Inserts

Carbide Grade	Geometry	Part No.			Insert Screws	Driver
		AM300®	AM200®	TiN		
C5 (P35)	Standard	OP-05T308-P	OP-05T308-H	OP-05T308-T	IS-10-1	8T-9
C1 (K35)	Standard	OP-05T308-1P	OP-05T308-1H	OP-05T308-1T	IS-10-1	8T-9
C2 (K25)	Standard	OP-05T308-2P	OP-05T308-2H	-	IS-10-1	8T-9
C5 (P35)	High Rake	OP-05T308-PHR	OP-05T308-HHR	-	IS-10-1	8T-9

Key on A60-1

A60: 22 - 23

A60: 2 - 4

Mounting screws sold in multiples of 4 | Adjusting screws sold in multiples of 4
 IC inserts sold in multiples of 10 | Insert screws sold in multiples of 10

i = Imperial (in)
m = Metric (mm)



Revolution Drill Holders

52 Series | Diameter Range: 3.200" - 3.400" (81.3mm - 86.4mm)

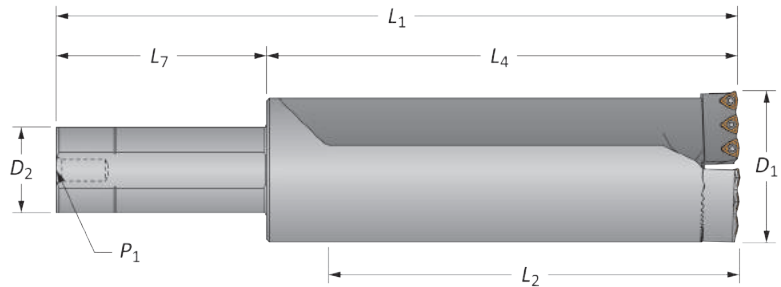

Straight Shank Imperial

Style	Length	D ₁ Range	Holder			Shank			Part No.*	Cartridges
			L ₂	L ₄	L ₁	D ₂	L ₇	P ₁		
Standard	1.0xD	3.200 - 3.400	3-27/64	5-1/64	9-33/64	2	4-1/2	1/4	R52X10-200L	C52-...
Standard	2.5xD	3.200 - 3.400	8-27/64	10-1/64	14-33/64	2	4-1/2	1/4	R52X25-200L	C52-...
Stacked Plate	1.0xD	3.200 - 3.400	3-31/64	5-5/64	9-37/64	2	4-1/2	1/4	SP52X10-200L	C52SP-...
Stacked Plate	2.5xD	3.200 - 3.400	8-31/64	10-5/64	14-37/64	2	4-1/2	1/4	SP52X25-200L	C52SP-...

*Holder includes cartridges; however, inserts are sold separately.

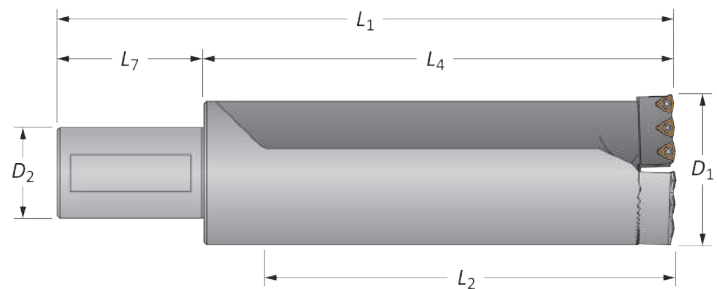

Straight Shank Metric

Style	Length	D ₁ Range	Holder			Shank			Part No.*	Cartridges
			L ₂	L ₄	L ₁	D ₂	L ₇	P ₁		
Standard	1.0xD	81.3 - 86.4	86.7	127.2	207.2	50	80	-	R52X10-50M	C52-...
Standard	2.5xD	81.3 - 86.4	213.7	254.2	334.2	50	80	-	R52X25-50M	C52-...
Stacked Plate	1.0xD	81.3 - 86.4	88.6	129.1	209.1	50	80	-	SP52X10-50M	C52SP-...
Stacked Plate	2.5xD	81.3 - 86.4	215.6	256.1	336.1	50	80	-	SP52X25-50M	C52SP-...

*Holder includes cartridges; however, inserts are sold separately.

A60: 22 - 23

A60: 2 - 4

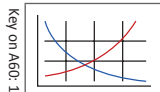

i = Imperial (in)
m = Metric (mm)



Revolution Drill Holders

52 Series | Diameter Range: 3.200" - 3.400" (81.3mm - 86.4mm)

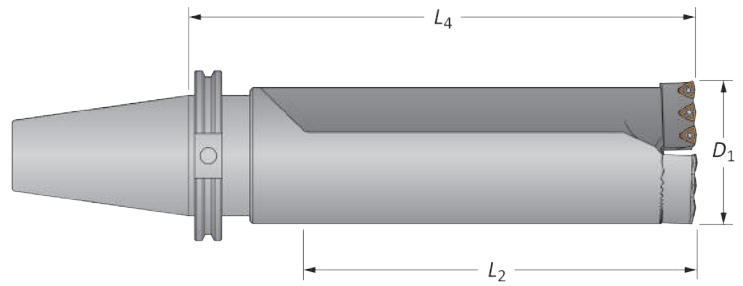

CV50 Shank

Style	Length	D ₁ Range	Holder		Shank	Part No.*	Cartridges
			L ₂	L ₄			
Standard	1.0xD	3.200 - 3.400	3-27/64	6-25/64	CV50	R52X10-CV50	C52-...
Standard	2.5xD	3.200 - 3.400	8-27/64	11-25/64	CV50	R52X25-CV50	C52-...
Stacked Plate	1.0xD	3.200 - 3.400	3-31/64	6-29/64	CV50	SP52X10-CV50	C52SP-...
Stacked Plate	2.5xD	3.200 - 3.400	8-31/64	11-29/64	CV50	SP52X25-CV50	C52SP-...

*Holder includes cartridges; however, inserts are sold separately.

Cartridges

Holder Part No.	Replacement Cartridges	Qty. Inserts Needed	Mounting Screw	Key Size	Adjusting Screw	Driver
R52...	C52-FIX	3	MS-19M-1	6mm	AS-18T9-1	8T-9
	C52-ADJ	3	MS-19M-1	6mm	AS-18T9-1	8T-9
SP52...	C52SP-FIX	3	MS-19M-1	6mm	AS-18T9-1	8T-9
	C52SP-ADJ	3	MS-19M-1	6mm	AS-18T9-1	8T-9

IC Inserts

Carbide Grade	Geometry	Part No.			Insert Screws	Driver
		AM300®	AM200®	TiN		
C5 (P35)	Standard	OP-05T308-P	OP-05T308-H	OP-05T308-T	IS-10-1	8T-9
C1 (K35)	Standard	OP-05T308-1P	OP-05T308-1H	OP-05T308-1T	IS-10-1	8T-9
C2 (K25)	Standard	OP-05T308-2P	OP-05T308-2H	-	IS-10-1	8T-9
C5 (P35)	High Rake	OP-05T308-PHR	OP-05T308-HHR	-	IS-10-1	8T-9

Key on A60-1

A60: 22 - 23

A60: 2 - 4

Mounting screws sold in multiples of 4 | Adjusting screws sold in multiples of 4
 IC inserts sold in multiples of 10 | Insert screws sold in multiples of 10

i = Imperial (in)
m = Metric (mm)



Revolution Drill Holders

54 Series | Diameter Range: 3.400" - 3.600" (86.4mm - 91.4mm)

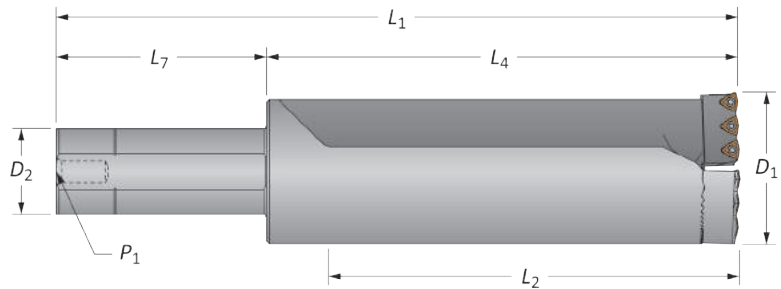

Straight Shank Imperial

Style	Length	D ₁ Range	Holder			Shank			Part No.*	Cartridges
			L ₂	L ₄	L ₁	D ₂	L ₇	P ₁		
Standard	1.0xD	3.400 - 3.600	3-21/32	5-17/64	9-49/64	2	4-1/2	1/4	R54X10-200L	C54-...
Standard	2.5xD	3.400 - 3.600	8-29/32	10-33/64	15-1/64	2	4-1/2	1/4	R54X25-200L	C54-...
Stacked Plate	1.0xD	3.400 - 3.600	3-23/32	5-21/64	9-53/64	2	4-1/2	1/4	SP54X10-200L	C54SP-...
Stacked Plate	2.5xD	3.400 - 3.600	8-31/32	10-37/64	15-5/64	2	4-1/2	1/4	SP54X25-200L	C54SP-...

*Holder includes cartridges; however, inserts are sold separately.

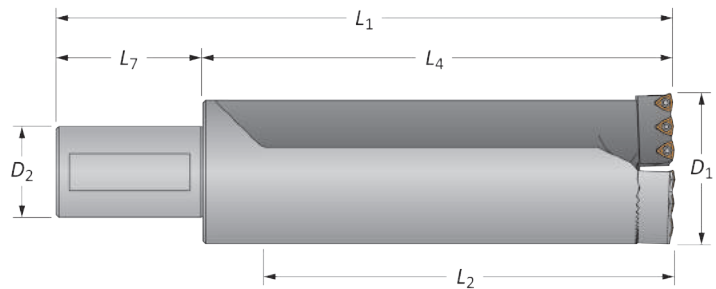

Straight Shank Metric

Style	Length	D ₁ Range	Holder			Shank			Part No.*	Cartridges
			L ₂	L ₄	L ₁	D ₂	L ₇	P ₁		
Standard	1.0xD	86.4 - 91.4	92.9	133.6	213.6	50	80	-	R54X10-50M	C54-...
Standard	2.5xD	86.4 - 91.4	226.3	266.9	346.9	50	80	-	R54X25-50M	C54-...
Stacked Plate	1.0xD	86.4 - 91.4	94.5	135.1	215.1	50	80	-	SP54X10-50M	C54SP-...
Stacked Plate	2.5xD	86.4 - 91.4	227.8	268.5	348.5	50	80	-	SP54X25-50M	C54SP-...

*Holder includes cartridges; however, inserts are sold separately.

A60: 22 - 23

A60: 2 - 4

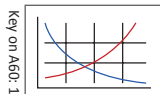

i = Imperial (in)
m = Metric (mm)



Revolution Drill Holders

54 Series | Diameter Range: 3.400" - 3.600" (86.4mm - 91.4mm)

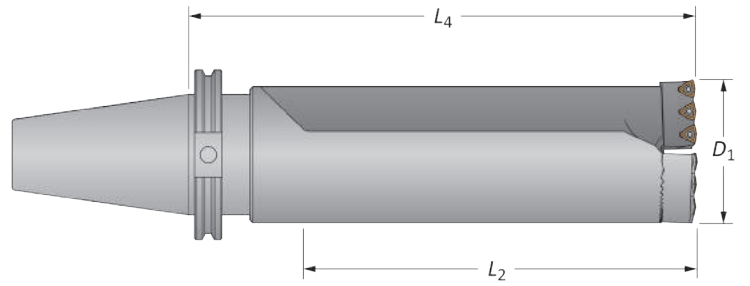

CV50 Shank

Style	Length	D_1 Range	Holder		Shank	Part No.*	Cartridges	
			L_2	L_4				
i	Standard	1.0xD	3.400 - 3.600	3-21/32	6-41/64	CV50	R54X10-CV50	C54-...
	Standard	2.5xD	3.400 - 3.600	8-29/32	11-57/64	CV50	R54X25-CV50	C54-...
	Stacked Plate	1.0xD	3.400 - 3.600	3-23/32	6-11/16	CV50	SP54X10-CV50	C54SP-...
	Stacked Plate	2.5xD	3.400 - 3.600	8-31/32	11-15/16	CV50	SP54X25-CV50	C54SP-...

*Holder includes cartridges; however, inserts are sold separately.

Cartridges

Holder Part No.	Replacement Cartridges	Qty. Inserts Needed	Mounting Screw	Key Size	Adjusting Screw	Driver
R54...	C54-FIX	3	MS-19M-1	6mm	AS-18T9-1	8T-9
	C54-ADJ	3	MS-19M-1	6mm	AS-18T9-1	8T-9
SP54...	C54SP-FIX	3	MS-19M-1	6mm	AS-18T9-1	8T-9
	C54SP-ADJ	3	MS-19M-1	6mm	AS-18T9-1	8T-9

IC Inserts

Carbide Grade	Geometry	Part No.			Insert Screws	Driver
		AM300®	AM200®	TiN		
C5 (P35)	Standard	OP-05T308-P	OP-05T308-H	OP-05T308-T	IS-10-1	8T-9
C1 (K35)	Standard	OP-05T308-1P	OP-05T308-1H	OP-05T308-1T	IS-10-1	8T-9
C2 (K25)	Standard	OP-05T308-2P	OP-05T308-2H	-	IS-10-1	8T-9
C5 (P35)	High Rake	OP-05T308-PHR	OP-05T308-HHR	-	IS-10-1	8T-9

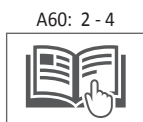
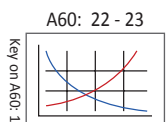

Mounting screws sold in multiples of 4 | Adjusting screws sold in multiples of 4
 IC inserts sold in multiples of 10 | Insert screws sold in multiples of 10

i = Imperial (in)
 m = Metric (mm)



Revolution Drill Holders

56 Series | Diameter Range: 3.600" - 3.800" (91.4mm - 96.5mm)

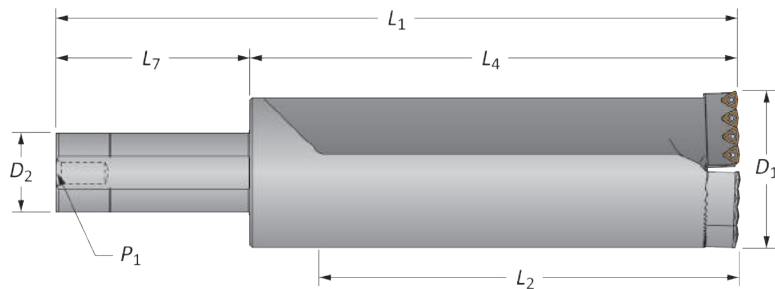

Straight Shank Imperial

Style	Length	D ₁ Range	Holder			Shank			Part No.*	Cartridges
			L ₂	L ₄	L ₁	D ₂	L ₇	P ₁		
Standard	1.0xD	3.600 - 3.800	3-7/8	5-3/4	10-1/4	2	4-1/2	1/4	R56X10-200L	C56-...
Standard	2.5xD	3.600 - 3.800	9-3/8	11-1/4	15-3/4	2	4-1/2	1/4	R56X25-200L	C56-...
Stacked Plate	1.0xD	3.600 - 3.800	3-15/16	5-13/16	10-5/16	2	4-1/2	1/4	SP56X10-200L	C56SP-...
Stacked Plate	2.5xD	3.600 - 3.800	9-7/16	11-5/16	15-13/16	2	4-1/2	1/4	SP56X25-200L	C56SP-...

*Holder includes cartridges; however, inserts are sold separately.

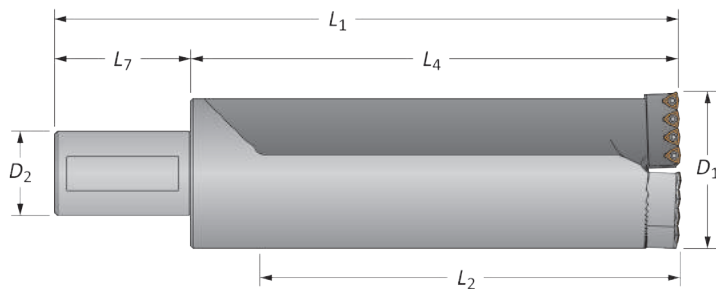

Straight Shank Metric

Style	Length	D ₁ Range	Holder			Shank			Part No.*	Cartridges
			L ₂	L ₄	L ₁	D ₂	L ₇	P ₁		
Standard	1.0xD	91.4 - 96.5	98.6	146.2	226.2	50	80	-	R56X10-50M	C56-...
Standard	2.5xD	91.4 - 96.5	238.3	285.9	365.9	50	80	-	R56X25-50M	C56-...
Stacked Plate	1.0xD	91.4 - 96.5	99.9	147.6	227.6	50	80	-	SP56X10-50M	C56SP-...
Stacked Plate	2.5xD	91.4 - 96.5	239.6	287.3	367.3	50	80	-	SP56X25-50M	C56SP-...

*Holder includes cartridges; however, inserts are sold separately.

A60: 22 - 23

A60: 2 - 4

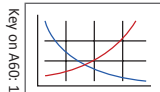

i = Imperial (in)
m = Metric (mm)



Revolution Drill Holders

56 Series | Diameter Range: 3.600" - 3.800" (91.4mm - 96.5mm)

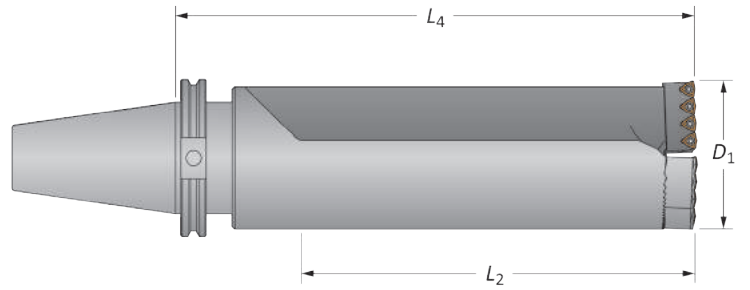

CV50 Shank

Style	Length	D ₁ Range	Holder		Shank	Part No.*	Cartridges
			L ₂	L ₄			
Standard	1.0xD	3.600 - 3.800	3-7/8	7-1/8	CV50	R56X10-CV50	C56-...
Standard	2.5xD	3.600 - 3.800	9-3/8	12-5/8	CV50	R56X25-CV50	C56-...
Stacked Plate	1.0xD	3.600 - 3.800	3-15/16	7-3/16	CV50	SP56X10-CV50	C56SP-...
Stacked Plate	2.5xD	3.600 - 3.800	9-7/16	12-11/16	CV50	SP56X25-CV50	C56SP-...

*Holder includes cartridges; however, inserts are sold separately.

Cartridges

Holder Part No.	Replacement Cartridges	Qty. Inserts Needed	Mounting Screw	Key Size	Adjusting Screw	Driver
R56...	C56-FIX	4	MS-21M-1	8mm	AS-18T9-1	8T-9
	C56-ADJ	4	MS-21M-1	8mm	AS-18T9-1	8T-9
SP56...	C56SP-FIX	4	MS-21M-1	8mm	AS-18T9-1	8T-9
	C56SP-ADJ	4	MS-21M-1	8mm	AS-18T9-1	8T-9

IC Inserts

Carbide Grade	Geometry	Part No.			Insert Screws	Driver
		AM300®	AM200®	TiN		
C5 (P35)	Standard	OP-05T308-P	OP-05T308-H	OP-05T308-T	IS-10-1	8T-9
C1 (K35)	Standard	OP-05T308-1P	OP-05T308-1H	OP-05T308-1T	IS-10-1	8T-9
C2 (K25)	Standard	OP-05T308-2P	OP-05T308-2H	-	IS-10-1	8T-9
C5 (P35)	High Rake	OP-05T308-PHR	OP-05T308-HHR	-	IS-10-1	8T-9

A60: 22 - 23

A60: 2 - 4

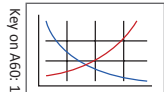

Mounting screws sold in multiples of 4 | Adjusting screws sold in multiples of 4
IC inserts sold in multiples of 10 | Insert screws sold in multiples of 10

i = Imperial (in)
m = Metric (mm)



Revolution Drill Holders

58 Series | Diameter Range: 3.800" - 4.000" (96.5mm - 101.6mm)

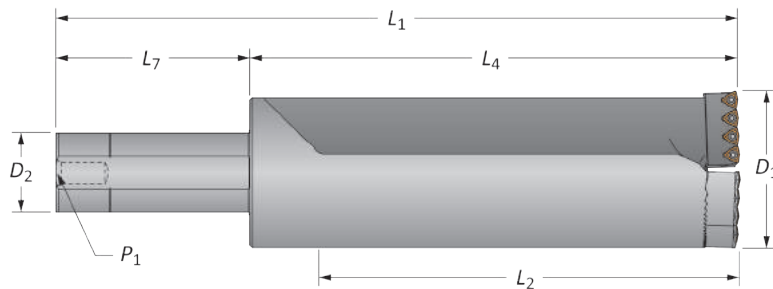

Straight Shank Imperial

Style	Length	D ₁ Range	Holder			Shank			Part No.*	Cartridges
			L ₂	L ₄	L ₁	D ₂	L ₇	P ₁		
Standard	1.0xD	3.800 - 4.000	3-7/8	5-3/4	10-1/4	2	4-1/2	1/4	R58X10-200L	C58-...
Standard	2.5xD	3.800 - 4.000	9-7/8	11-3/4	16-1/4	2	4-1/2	1/4	R58X25-200L	C58-...
Stacked Plate	1.0xD	3.800 - 4.000	3-15/16	5-13/16	10-5/16	2	4-1/2	1/4	SP58X10-200L	C58SP-...
Stacked Plate	2.5xD	3.800 - 4.000	9-15/16	11-13/16	16-5/16	2	4-1/2	1/4	SP58X25-200L	C58SP-...

*Holder includes cartridges; however, inserts are sold separately.

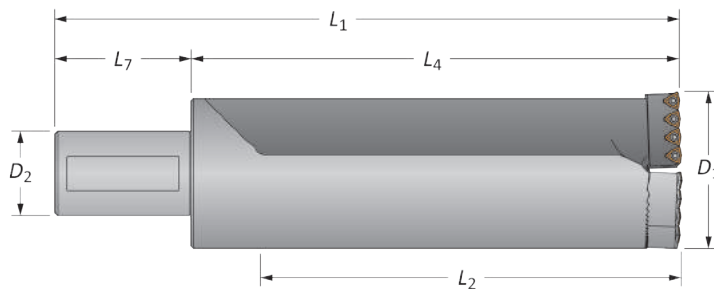

Straight Shank Metric

Style	Length	D ₁ Range	Holder			Shank			Part No.*	Cartridges
			L ₂	L ₄	L ₁	D ₂	L ₇	P ₁		
Standard	1.0xD	96.5 - 101.6	98.6	146.2	226.2	50	80	-	R58X10-50M	C58-...
Standard	2.5xD	96.5 - 101.6	251.0	298.6	378.6	50	80	-	R58X25-50M	C58-...
Stacked Plate	1.0xD	96.5 - 101.6	99.8	147.4	227.4	50	80	-	SP58X10-50M	C58SP-...
Stacked Plate	2.5xD	96.5 - 101.6	252.2	299.8	379.8	50	80	-	SP58X25-50M	C58SP-...

*Holder includes cartridges; however, inserts are sold separately.

A60: 22 - 23

A60: 2 - 4

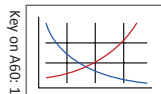

i = Imperial (in)
m = Metric (mm)



Revolution Drill Holders

58 Series | Diameter Range: 3.800" - 4.000" (96.5mm - 101.6mm)

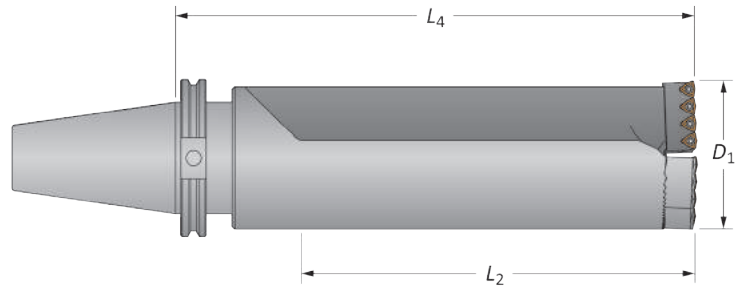

CV50 Shank

Style	Length	D ₁ Range	Holder		Shank	Part No.*	Cartridges
			L ₂	L ₄			
Standard	1.0xD	3.800 - 4.000	3-7/8	7-1/8	CV50	R58X10-CV50	C58-...
Standard	2.5xD	3.800 - 4.000	9-7/8	13-1/8	CV50	R58X25-CV50	C58-...
Stacked Plate	1.0xD	3.800 - 4.000	3-15/16	7-3/16	CV50	SP58X10-CV50	C58SP-...
Stacked Plate	2.5xD	3.800 - 4.000	9-15/16	13-3/16	CV50	SP58X25-CV50	C58SP-...

*Holder includes cartridges; however, inserts are sold separately.

Cartridges

Holder Part No.	Replacement Cartridges	Qty. Inserts Needed	Mounting Screw	Key Size	Adjusting Screw	Driver
R58...	C58-FIX	4	MS-21M-1	8mm	AS-18T9-1	8T-9
	C58-ADJ	4	MS-21M-1	8mm	AS-18T9-1	8T-9
SP58...	C58SP-FIX	4	MS-21M-1	8mm	AS-18T9-1	8T-9
	C58SP-ADJ	4	MS-21M-1	8mm	AS-18T9-1	8T-9

IC Inserts

Carbide Grade	Geometry	Part No.			Insert Screws	Driver
		AM300®	AM200®	TiN		
C5 (P35)	Standard	OP-05T308-P	OP-05T308-H	OP-05T308-T	IS-10-1	8T-9
C1 (K35)	Standard	OP-05T308-1P	OP-05T308-1H	OP-05T308-1T	IS-10-1	8T-9
C2 (K25)	Standard	OP-05T308-2P	OP-05T308-2H	-	IS-10-1	8T-9
C5 (P35)	High Rake	OP-05T308-PHR	OP-05T308-HHR	-	IS-10-1	8T-9

A60: 22 - 23

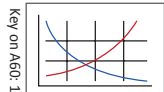

A60: 2 - 4



Mounting screws sold in multiples of 4 | Adjusting screws sold in multiples of 4
IC inserts sold in multiples of 10 | Insert screws sold in multiples of 10

I = Imperial (in)
M = Metric (mm)

Recommended Cutting Data | Imperial (inch)

ISO	Material	Hardness (BHN)	Speed (SFM)			Feed Rate (IPR)
			 AM300®	 AM200®	 TiN	
P	Free Machining Steel 1118, 1215, 12L14, etc.	100 - 250	900 - 1300	850 - 1200	700 - 900	.0035 - .007
	Low Carbon Steel 1010, 1020, 1025, 1522, 1144, etc.	85 - 275	850 - 1250	800 - 1150	650 - 850	.003 - .0065
	Medium Carbon Steel 1030, 1040, 1050, 1527, 1140, 1151, etc.	125 - 325	800 - 1050	750 - 950	600 - 850	.0035 - .0065
	Alloy Steel 4140, 5140, 8640, etc.	125 - 375	750 - 1000	700 - 900	600 - 850	.0035 - .0065
	High Strength Alloy 4340, 4330V, 300M, etc.	225 - 400	600 - 850	550 - 750	400 - 650	.003 - .005
	Structural Steel A36, A285, A516, etc.	100 - 350	850 - 1050	800 - 950	650 - 850	.003 - .0065
	Tool Steel H-13, H-21, A-4, O-2, S-3, etc.	150 - 250	400 - 800	350 - 700	250 - 650	.0025 - .005
S	High Temp Alloy Hastelloy B, Inconel 600, etc.	140 - 310	250 - 450	250 - 350	150 - 300	.0025 - .005
M	Stainless Steel 400 Series 416, 420, etc.	185 - 350	600 - 850	550 - 750	400 - 650	.003 - .006
	Stainless Steel 300 Series 304, 316, 17-4PH, etc.	135 - 275	600 - 850	550 - 750	400 - 650	.003 - .006
	Super Duplex Stainless Steel	135 - 275	500 - 750	450 - 650	300 - 550	.002 - .005
K	Nodular, Grey, Ductile Cast Iron	120 - 320	700 - 900	650 - 800	500 - 700	.004 - .008
N	Cast Aluminum	30 - 180	1250 - 1650	1200 - 1550	950 - 1100	.006 - .012
	Wrought Aluminum	30 - 180	1250 - 1650	1200 - 1550	950 - 1100	.006 - .012
	Brass	30 - 100	950 - 1350	900 - 1250	750 - 1100	.005 - .009

Material Constants

Type of Material	Hardness (BHN)	K _m (lbs/in ²)
Free Machining Steel	100 - 250	0.75
Low Carbon Steel	85 - 275	0.85
Medium Carbon Steel	125 - 325	0.90
Alloy Steel	125 - 375	1.00
High Strength Steel	225 - 400	1.15
Structural Steel	100 - 350	1.00
Tool Steel	150 - 250	0.90
High Temperature Alloy	140 - 310	1.44
Titanium Alloy	140 - 310	0.72
Aerospace Alloy	185 - 350	0.70
Stainless Steel 400 Series	185 - 350	1.08
Stainless Steel 300 Series	135 - 275	0.94
Super Duplex Stainless Steel	135 - 275	0.94
Wear Plate	400 - 600	1.60
Hardened Steel	300 - 500	1.40
Nodular, Ductile Cast Iron	120 - 320	0.65
Grey Cast Iron	120 - 320	0.75
Cast Aluminum	30 - 180	0.40
Wrought Aluminum	30 - 180	0.40
Aluminum Bronze	100 - 250	0.50
Brass	100	0.35
Copper	60	0.30



Formulas

1.	RPM = $(3.82 \cdot \text{SFM}) / \text{DIA}$ <i>where:</i> RPM = revolutions per minute (rev/min) SFM = speed (ft/min) DIA = diameter of drill (inch)
2.	HP = $(0.6676 \cdot \text{DIA}^2 \cdot \text{IPR} \cdot \text{RPM} \cdot K_m) / 0.80$ <i>where:</i> Tool Power = tool power (HP) DIA = diameter of drill (inch) IPR = feed rate (in/rev) RPM = revolutions per minute (rev/min) K _m = specific cutting energy (lbs/in ²) machine efficiency (using 0.80 as constant)
3.	Thrust = $148,500 \cdot \text{IPR} \cdot \text{DIA} \cdot K_m$ <i>where:</i> Thrust = axial thrust (lbs) IPR = feed rate (in/rev) DIA = diameter of drill (inch) K _m = specific cutting energy (lbs/in ²)
5.	Torque = $(\text{HP} \cdot 5252) / \text{RPM}$ <i>where:</i> Torque = torque (ft/lbs) HP = tool power (HP) RPM = revolutions per minute (rev/min)

The table and equations on this page are found in the *Machinery's Handbook*. Permission to simplify and print the equations is granted by the Editor of the *Machinery's Handbook*.

IMPORTANT: The speeds and feeds listed above are considered a general starting point for all applications. Factory technical assistance is available for your specific applications through our Application Engineering department.

Recommended Cutting Data | Metric (mm)

ISO	Material	Hardness (BHN)	Speed (M/min)			Feed Rate (mm/rev)
			 AM300®	 AM200®	 TiN	
P	Free Machining Steel 1118, 1215, 12L14, etc.	100 - 250	274 - 396	259 - 366	213 - 274	0.09 - 0.18
	Low Carbon Steel 1010, 1020, 1025, 1522, 1144, etc.	85 - 275	259 - 381	244 - 351	198 - 259	0.08 - 0.17
	Medium Carbon Steel 1030, 1040, 1050, 1527, 1140, 1151, etc.	125 - 325	244 - 320	229 - 290	183 - 259	0.09 - 0.17
	Alloy Steel 4140, 5140, 8640, etc.	125 - 375	229 - 305	213 - 274	183 - 259	0.09 - 0.17
	High Strength Alloy 4340, 4330V, 300M, etc.	225 - 400	183 - 259	168 - 229	122 - 198	0.08 - 0.13
	Structural Steel A36, A285, A516, etc.	100 - 350	259 - 320	244 - 290	198 - 259	0.08 - 0.17
	Tool Steel H-13, H-21, A-4, O-2, S-3, etc.	150 - 250	122 - 244	107 - 213	76 - 198	0.06 - 0.13
S	High Temp Alloy Hastelloy B, Inconel 600, etc.	140 - 310	76 - 137	76 - 107	46 - 91	0.06 - 0.11
M	Stainless Steel 400 Series 416, 420, etc.	185 - 350	183 - 259	168 - 229	122 - 198	0.08 - 0.15
	Stainless Steel 300 Series 304, 316, 17-4PH, etc.	135 - 275	183 - 259	168 - 229	122 - 198	0.08 - 0.15
	Super Duplex Stainless Steel	135 - 275	152 - 228	137 - 198	91 - 152	0.05 - 0.12
K	Nodular, Grey, Ductile Cast Iron	120 - 320	213 - 274	198 - 244	152 - 213	0.10 - 0.20
N	Cast Aluminum	30 - 180	381 - 503	381 - 472	290 - 335	0.15 - 0.30
	Wrought Aluminum	30 - 180	381 - 503	381 - 472	290 - 335	0.15 - 0.30
	Brass	30 - 100	290 - 411	274 - 381	229 - 335	0.13 - 0.23

Material Constants

Type of Material	Hardness (BHN)	K _m (lbs/in ²)
Free Machining Steel	100 - 250	5.17
Low Carbon Steel	85 - 275	5.86
Medium Carbon Steel	125 - 325	6.21
Alloy Steel	125 - 375	6.90
High Strength Steel	225 - 400	7.93
Structural Steel	100 - 350	6.90
Tool Steel	150 - 250	6.21
High Temperature Alloy	140 - 310	9.93
Titanium Alloy	140 - 310	4.97
Aerospace Alloy	185 - 350	4.48
Stainless Steel 400 Series	185 - 350	7.45
Stainless Steel 300 Series	135 - 275	6.48
Super Duplex Stainless Steel	135 - 275	6.48
Wear Plate	400 - 600	11.04
Hardened Steel	300 - 500	9.66
Nodular, Ductile Cast Iron	120 - 320	4.48
Grey Cast Iron	120 - 320	5.17
Cast Aluminum	30 - 180	2.76
Wrought Aluminum	30 - 180	2.76
Aluminum Bronze	100 - 250	3.45
Brass	100	2.41
Copper	60	2.07

Formulas

1. RPM = $(318.31 \cdot M/min) / DIA$ where: RPM = revolutions per minute (rev/min) M/min = speed (M/min) DIA = diameter of drill (mm)
2. kW = $(DIA^2 \cdot mm/rev \cdot RPM \cdot K_m) / 181,018$ where: kW = tool power (kW) DIA = diameter of drill (mm) mm/rev = feed rate (mm/rev) RPM = revolutions per minute (rev/min) K _m = specific cutting energy (kPa) machine efficiency (using 181,018 as constant)
3. Thrust = $148.78 \cdot mm/rev \cdot DIA \cdot K_m$ where: Thrust = axial thrust (N) mm/rev = feed rate (mm/rev) DIA = diameter of drill (mm) K _m = specific cutting energy (kPa)
5. Torque = $(kW \cdot 9549.3) / RPM$ where: Torque = torque (Nm) HP = tool power (kW) RPM = revolutions per minute (rev/min)

The table and equations on this page are found in the *Machinery's Handbook*. Permission to simplify and print the equations is granted by the Editor of the *Machinery's Handbook*.

IMPORTANT: The speeds and feeds listed above are considered a general starting point for all applications. Factory technical assistance is available for your specific applications through our Application Engineering department.

A
DRILLING
B
BORING
C
REAMING
D
BURNISHING
E
THREADING
X
SPECIALS

Guaranteed Test / Demo Application Form

Distributor PO #	
------------------	--

The following must be filled out completely before your test will be considered

Distributor Information

Company Name: _____
 Contact: _____
 Account Number: _____
 Phone: _____
 Email: _____

End User Information

Company Name: _____
 Contact: _____
 Industry: _____
 Phone: _____
 Email: _____

Current Process

List all tooling, coatings, substrates, speeds and feeds, tool life, and any problems you are experiencing

Test Objective

List what would make this a successful test (i.e. penetration rate, finish, tool life, hole size, etc.)

Application Information

Hole Diameter: _____ in/mm	Tolerance: _____	Material: _____ (4150 / A36 / Cast Iron / etc.)
Pre-existing Diameter: _____ in/mm	Depth of Cut: _____ in/mm	Hardness: _____ (BHN / Rc)
Required Finish: _____ RMS	State: _____	(Casting / Hot rolled / Forging)

Machine Information

Machine Type: _____ (Lathe / Screw machine / Machine center / etc.)	Builder: _____ (Haas, Mori Seiki, etc.)	Model #: _____
Shank Required: _____ (CAT50 / Morse taper, etc.)		Power: _____ HP/KW
Rigidity: _____	Orientation: _____	Tool Rotating: _____
<input type="checkbox"/> Excellent	<input type="checkbox"/> Vertical	<input type="checkbox"/> Yes
<input type="checkbox"/> Good	<input type="checkbox"/> Horizontal	<input type="checkbox"/> No
<input type="checkbox"/> Poor		Thrust: _____ lbs/N

Coolant Information

Coolant Delivery: _____ (Through tool / Flood)	Coolant Pressure: _____ PSI / bar
Coolant Type: _____ (Air mist, oil, synthetic, water soluble, etc.)	Coolant Volume: _____ GPM / LPM

Requested Tooling

QTY	Item Number

QTY	Item Number



Allied Machine & Engineering
 120 Deeds Drive
 Dover, OH 44622

Telephone: (330) 343-4283
 Toll Free USA & Canada: (800) 321-5537
 Fax: (330) 602-3400

Warranty Information



Allied Machine & Engineering ("Allied Machine") warrants to original equipment manufacturers, distributors, industrial and commercial users of its products for one year from the original date of sale that each new product manufactured or supplied by Allied Machine shall be free from defects in material and workmanship.

Allied Machine's sole and exclusive obligation under this warranty is limited to, at its option, without additional charge, replacing or repairing this product or issuing a credit. For this warranty to be applied, the product must be returned freight prepaid to the plant designated by an Allied Machine representative and which, upon inspection, is determined by Allied Machine to be defective in material and workmanship.

Complete information as to operating conditions, machine, setup, and the application of cutting fluid should accompany any product returned for inspection. This warranty shall not apply to any Allied Machine products which have been subjected to misuse, abuse, improper operating conditions, improper machine setup or improper application of cutting fluid or which have been repaired or altered if such repair or alteration, in the judgement of Allied Machine, would adversely affect the performance of the product.

THIS WARRANTY IS IN LIEU OF ALL OTHER WARRANTIES, EXPRESS OR IMPLIED, INCLUDING ANY IMPLIED WARRANTY OF MERCHANTABILITY OR FITNESS FOR A PARTICULAR PURPOSE. Allied Machine shall have no liability or responsibility for any claim, whether in contract, tort or otherwise, for any loss or damage arising out of, connected with, or resulting from the manufacture, sale, delivery or use of any product sold hereunder, in excess of the cost of replacement or repair as provided herein.

Allied Machine shall not be liable in contract or in tort (including, without limitation, negligence, strict liability or otherwise) for economic losses of any kind or for any special, incidental, indirect, consequential, punitive or exemplary damages arising in any way out of the performance of, or failure to perform this agreement.

ALL PRICES, DELIVERIES, DESIGNS, AND MATERIALS ARE SUBJECT TO CHANGE WITHOUT NOTICE.



Allied Machine & Engineering
Registered to ISO 9001
10001329

United States

Allied Machine & Engineering

120 Deeds Drive
Dover OH 44622
United States

Phone:
+1.330.343.4283

Fax:
+1.330.602.3400

Toll Free USA and Canada:
800.321.5537

Toll Free USA and Canada:
800.223.5140

Allied Machine & Engineering

485 W Third Street
Dover OH 44622
United States

Phone:
+1.330.343.4283

Fax:
+1.330.364.7666
(Engineering Dept.)

Toll Free USA and Canada:
800.321.5537

Europe

Allied Machine & Engineering Co. (Europe) Ltd.

93 Vantage Point
Pensnett Estate
Kingswinford
West Midlands
DY6 7FR England

Phone:
+44 (0) 1384.400900

Wohlhaupter GmbH

Maybachstrasse 4
Postfach 1264
72636 Frickenhausen
Germany

Phone:
+49 (0) 7022.408.0

Fax:
+49 (0) 7022.408.212

Asia

Wohlhaupter India Pvt. Ltd.

B-23, 2nd Floor
B Block Community Centre
Janakpuri, New Delhi - 110058
India

Phone:
+91 (0) 11.41827044



日易晖 机械

GOLDEN CARBIDE PRECISION

Room 2101-2102, Gateway International Plaza, Building A, No.325, Tian Yao Qiao Road, Shanghai, China Zip: 200030
2/F, No. 40, Sec. 2, Tun Hwa S. Road, Daan Dist., Taipei, Taiwan Zip:106

Shanghai: 86-21-3363-2088

Beijing: 86-10-8851-8900

Chengdu 86-28-8526-6681

Changchun: 86-431-8461-7085

Chongqing: 86-23-6757-3205

Bonded Wh: 86-21-5868-3075

Taipei: 886-2-2705-8448

Taichung: 886-4-24638159

Website: www.goldencarbide.com