



# ALLIED MACHINE & ENGINEERING

Holemaking Solutions for Today's Manufacturing



## Master Product CATALOG



Drilling



Boring



Reaming



Burnishing



Threading



Specials

[www.alliedmachine.com](http://www.alliedmachine.com)

It's so much easier when you make  
**BETTER CHIPS**

Allied Machine specializes in developing innovative solutions designed to *pulverize* material. Our tools achieve the chip formation and chip evacuation you need to increase your production.



Allied Machine & Engineering  
Registered to ISO 9001  
10001329



## Our Commitment to YOU



Manufacturing is the DNA of success everywhere in the world. When you're manufacturing, you're building, creating, and developing something that physically didn't exist before.

At Allied Machine, our core purpose is to provide practical and dependable solutions to improve your manufacturing processes. We know you face challenges and difficulties every day, so we're here to simplify your holmaking processes and improve your production.

However, many factors must be incorporated to truly improve production.

Some of those factors include increasing penetration rates while also improving chip formation and evacuation, reducing scrap rates by producing better parts, reducing setup times, and increasing tool life to get the most from your investment.

Not only does our tooling achieve these results, but our customer service is also an extension of our tooling advantages. Our Application Engineers and Field Sales Engineers are available to assist with any problems you encounter. Don't hesitate to put their skills and knowledge to the test. They won't disappoint.

This is our commitment to manufacturing, and it's our promise to you.



**ALLIED MACHINE**  
**& ENGINEERING**

## North America

**Allied Machine**  
120 Deeds Drive  
Dover, OH 44622  
United States

**Allied Machine**  
485 West 3rd Street  
Dover, OH 44622  
United States

### **ThreadMills USA™**

4185 Crosstowne Ct #B  
Evans, GA 30809  
United States

### **Superior®**

1285 S Patton St.  
Xenia, OH 45385  
United States

## Europe

**Allied Machine Europe**  
93 Vantage Point  
Pensnett Estate  
Kingswinford  
West Midlands  
DY6 7FR, United Kingdom

### **Wohlhaupter™ GmbH**

Maybachstrasse 4  
Postfach 1264  
72636 Frickenhausen  
Germany

## Asia

**Wohlhaupter™ India**  
B-23, 2nd Floor  
B Block Community Centre  
Janakpuri, New Delhi - 110058  
India



Allied Machine & Engineering is a worldwide leader in holemaking and finishing solutions. We are committed to providing practical and dependable solutions to our customers through innovative designs and superior customer and technical support.

We continue to expand our product offering in order to provide new and different solutions. With Field Sales Engineers located around the world, we position ourselves to provide technical support on site, right at your spindle.



**ALLIED MACHINE  
& ENGINEERING**

[www.alliedmachine.com](http://www.alliedmachine.com)

The background features a light gray dot grid pattern overlaid with various geometric shapes, including concentric circles, overlapping rectangles, and intersecting lines, creating a technical or architectural aesthetic.

# Master Product CATALOG

# Flipbooks and Digital PDF Downloads

## Every Section Available Online

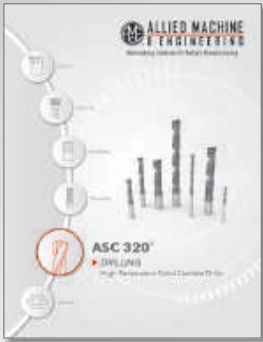

**Section A10**  
ASC 320®



**Section A20 (AMPC-A2\*)**  
GEN3SYS® XT and XT Pro



**Section A30**  
Original T-A® and GEN2 T-A®



**Section A40 (AMPC-A4\*)**  
High Performance / Universal



**Section A50**  
APX™ Drill



**Section A60**  
Revolution Drill®



**Section A70**  
Opening Drill®



**Section A91**  
Structural Steel Solutions



**Section A92**  
AccuPort 432®



**Section A93**  
BT-A Drill



**Section B10**  
Wohlhaupter™ Product Overview



**Section B20 (AMPC-B2\*)**  
Criterion® Modular Boring



**Section C**  
Reaming



**Section D (AMPC-D\*)**  
Burnishing



**Section E**  
Threading



**Section X**  
Special Tooling Solutions



**EcoCut (EC\*)**  
Multifunction Tooling



**Wohlhaupter™ (WOHLCAT\*)**  
MultiBore® Systems Tools



**VarioBore® (WOHLVARIOBORE\*)**  
Wohlhaupter™ VarioBore®



**AccuThread™ T3 (E-AT3\*)**  
3-Tooth Style Thread Mills

View, download, and share individual product line sections at  
[www.alliedmachine.com/Literature](http://www.alliedmachine.com/Literature)

\*Also available in print

# Find what you need. Now.

Flipbook gives you the ability to search for a specific item number and find the page(s) where it's located. Save time searching the catalog by hand if you already know what item number you need. Visit the Flipbooks now at [alliedmachine.com/support/literature](http://alliedmachine.com/support/literature).

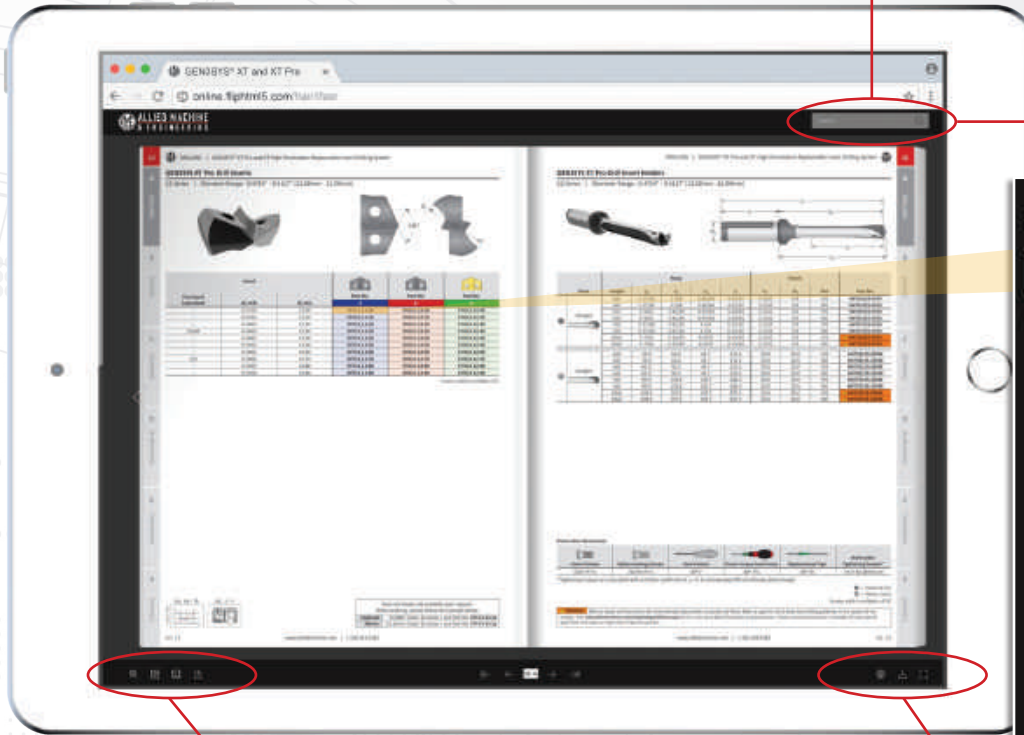

Zoom in for a closer look

Set the catalog to auto flip

Scroll through the pages in thumbnail view

Share the Flipbook with others



Print the full catalog or specific pages

View in full screen mode

Download the catalog PDF

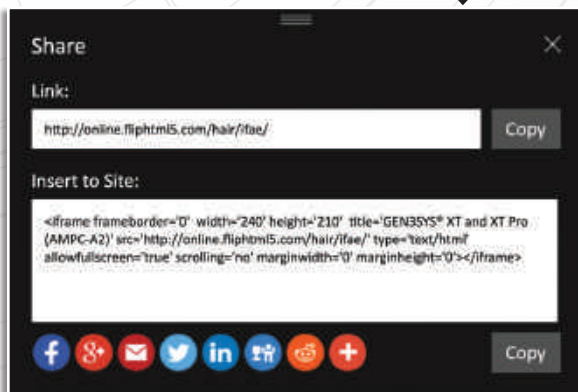

Share the link to each Flipbook via email and social media

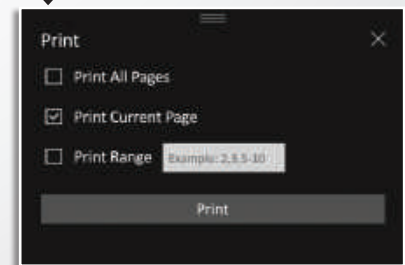

## The Foundation

Since 1941, Allied Machine & Engineering has provided dependable and practical holmaking solutions to the world. What was once a small job shop in Ohio is now a worldwide leader in cutting tool technology. With three manufacturing facilities in Ohio, one in Georgia, another in Germany, and headquarters in both the United States and Europe, Allied Machine is positioned to bring innovative solutions and technical expertise directly to the customers' hands.



## The Beginning

Harold E. Stokey founded Allied Machine & Engineering to aid the war effort, manufacturing taper bearing lock nuts for the production of M1 tanks. Years later, after a sales meeting gone wrong, Stokey possessed a warehouse stocked with spade drill inserts. He set forth into the industry that would become Allied Machine's thriving identity: holmaking.



## The T-A<sup>®</sup>

When Harold's son, William H. Stokey, became the president and CEO, he developed the Throw Away, or T-A, spade drill insert system. The T-A revolutionized the holmaking industry, launching Allied Machine ahead of the competition. Since then, numerous innovations and advancements have been created from the T-A's inspiration.



## The Innovation

Since the development of the T-A, Allied Machine has expanded its product offering to support a vast range of customer applications, including large diameter and deep hole drilling, boring, reaming, burnishing, porting, and threading.

## The People

Allied Machine understands that high quality products are only one facet of success. Our customer support is crucial to what we do, and that's why we make sure the best engineers and customer service associates are in place to assist our customers around the world.

## The Future

With over 75 years of experience, Allied Machine has encountered the challenges of growth and success. By investing in cutting edge technology and the brightest and sharpest minds, our knowledge and capabilities continue to expand and grow every day.



**Steve Stokey**  
Executive Vice President

**William H. Stokey**  
President and CEO

**Mike Stokey**  
Executive Vice President



**ALLIED MACHINE  
& ENGINEERING**

Holmaking Solutions for Today's Manufacturing

**WOHLHAUPTER<sup>®</sup>**



**SUPERION<sup>®</sup>**

**CRITERION<sup>®</sup>**



# Contents

	<b>Introduction</b>	
	Product Offering Overview . . . . .	ii - v
	Customer Support and Training Information . . . . .	vi - vii
	Navigating the Catalog . . . . .	viii - ix
	Drilling Product Selection Guide . . . . .	x - xi
	Online Tools . . . . .	xii - xiii
<b>A10</b>	<b>ASC 320®</b> Solid Carbide Drilling Solutions	A10: 1 - 15
<b>A20</b>	<b>GEN3SYS® XT and XT Pro</b> High Penetration Replaceable Insert Drilling System	A20: 1 - 89
<b>A30</b>	<b>T-A® Drilling System</b> Replaceable Insert Drilling System	A30: 1 - 147
<b>A40</b>	<b>High Performance / Universal</b> Replaceable Insert Drilling System	A40: 1 - 49
<b>A50</b>	<b>APX™ Drill</b> Large Diameter / Deep Hole Drilling System	A50: 1 - 31
<b>A60</b>	<b>Revolution Drill®</b> Large Diameter Drilling System	A60: 1 - 25
<b>A70</b>	<b>Opening Drill®</b> Large Diameter Drilling System	A70: 1 - 19
<b>A91</b>	<b>Structural Steel Solutions</b> GEN3SYS® XT and T-A® Replaceable Insert Drilling Systems	A91: 1 - 43
<b>A92</b>	<b>AccuPort 432®</b> Hydraulic Porting Solutions	A92: 1 - 39
<b>A93</b>	<b>BT-A Drill</b> BTA (STS) Machining Solutions	A93: 1 - 9
<b>B10</b>	<b>Wohlhaupter™ Product Overview</b> High Precision Boring Systems	B10: 1 - 17
<b>B20</b>	<b>Criterion®</b> Modular Boring Systems	B20: 1 - 65
<b>C</b>	<b>Reaming</b> ALVAN® Reaming Systems by S.C.A.M.I.®	C: 1 - 81
<b>D</b>	<b>Burnishing</b> Roller Burnishing Systems by S.C.A.M.I.®	D: 1 - 47
<b>E</b>	<b>Threading</b> Solid Carbide and Indexable Thread Milling Solutions	E: 1 - 67
<b>X</b>	<b>Specials</b> Special Tooling Solutions	X: 1 - 26
	<b>Index</b>	INDEX: 1 - 5

Visit [www.alliedmachine.com/Literature](http://www.alliedmachine.com/Literature) to access the complete Wohlhaupter™ product catalogs.

**For a Guaranteed Test/Demo Application, see the last page of this book.**

## Product Offering Overview

### Replaceable Insert Drills

- Reduce costs by decreasing setup time and utilizing a single holder for the lives of multiple inserts
- Provide flexibility to quickly switch between inserts with different geometries
- Products:
  - GEN3SYS® XT | GEN3SYS® XT Pro
  - T-A® | T-A® GEN2
  - High Performance | Universal



### Indexable Insert Drills

- Protect your investment and reduce your inventory with replaceable cartridges that allow the same holder to be used repeatedly
- Indexable inserts increase productivity and tool life while reducing costs
- Products:
  - 4TEX® Drill
  - Revolution Drill®
  - Opening Drill®



### Replaceable / Indexable Insert Drills

- Drill large diameter holes and maximize penetration rates even on low horsepower machines
- Delivers strength and versatility needed for any deep hole drilling application
- Holders cover a range of sizes with the replaceable heads determining the cutting diameter
- Products:
  - APX™ Drill



### Solid Carbide Drills

- Offer greater strength and stability when drilling tougher materials
- Available in diameters from 3mm - 20mm
- Can be made-to-order specifically for your application (Superion® quoted specials)
  - ASC 320®
  - Superion®



A DRILLING  
B BORING  
C REAMING  
D BURNISHING  
E THREADING  
X SPECIALS

### Structural Steel Solutions



- Deliver outstanding performance and durability in structural steel applications
- Designed to produce optimal results in difficult-to-machine materials
- Available in multiple lengths and diameters
- T-A® style drills have different insert geometry options to improve performance depending on material
- Products:
  - T-A® | T-A® GEN2
  - GEN3SYS® XT Pro

### BTA (STS) Machining Solutions

- The internal ejection system flushes chips and debris from the hole with no interference to the cutting process
- Utilizes the advantages of the T-A® drill insert
- Designed to significantly increase penetration rates over brazed heads and traditional gun drills
- Products:
  - BT-A Drill



### Hydraulic Port Contour Cutters



- Save significant time and money by performing four processes in one step
- Replaceable insert design reduces costs, inventory, and setup times
- Available in four industry specifications:
  - Imperial: SAE J-1926
  - Metric: ISO 6149-1:2006
  - Military: SAE AS5202
  - John Deere: JDS-G173.1
- Products:
  - AccuPort 432®



### Enhanced Special Drilling Capabilities

- Allied Machine engineers are available to meet with you to evaluate your application and recommend the best solution for you
- Special drilling solutions can incorporate advanced features such as adjustable diameter locations, multiple steps, additional coolant designs, special lengths and diameters, and more
- Special drills can drastically reduce your cost per hole and increase your overall productivity by eliminating multiple processes and increasing tool life



## Product Offering Overview

### WOHLHAUPTER®

#### High Precision Boring Systems

- Designs available for high volume applications that increase rigidity to improve performance
- Versatile boring heads that are flexible with changing applications while maintaining excellent performance
- Provides high precision with absolute repeatability to ensure every part is held to tolerance
- Offers an industry leading modular shank connection that maintains rigidity and reduces inventory on your boring system
- Available with both digital and analog settings
- Products:
  - Wohlhaupter™ Boring Tools

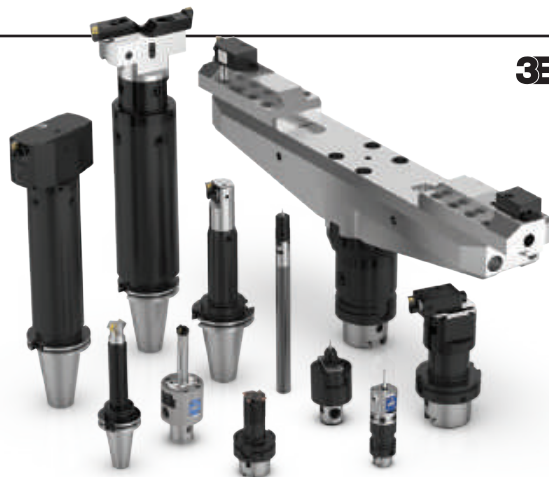

3ETECH



NOTE: Adjustment accuracy of 0.0001" or 0.002mm on diameter



### CRITERION®

#### Modular Boring Systems

- The modular capabilities are ideal for use across multiple different projects
- Offers versatile boring heads suitable for job shops and tooling rooms
- Provides an economical solution for low volume and/or short-term production applications
- Offers finish boring solutions
- Products:
  - Criterion® Boring Tools

### S.C.A.M.I.®

#### Expandable Reaming Solutions

- Expandable cutting diameters accommodate for wear, which extends tool life
- Replaceable cutting heads and rings reduce waste and improve production time versus solid high speed steel and carbide reamers
- Hold tight tolerances to ensure processes are performed to accurate specifications
- Reduce tooling costs because many items are available for reconditioning
- Products:
  - ALVAN® Reamers



### S.C.A.M.I.®

#### Roller Burnishing Solutions

- Produce excellent surface finishes
- Provide accurate size control
- Increase surface hardness
- Solutions for both through hole and blind hole applications
- Products:
  - S.C.A.M.I.® Roller Burnishing Tools



A DRILLING  
B BORING  
C REAMING  
D BURNISHING  
E THREADING  
X SPECIALS



### Solid Carbide Thread Mills

- Available with coolant through options
- Cover a wide range of thread forms
- Provide optimal solutions for both high production projects and short-run applications
- Products
  - AccuThread™ 856
  - AccuThread™ T3
  - ThreadMills USA™



### Indexable Insert Thread Mills

- Three insert lengths are available that cover a wide range of thread forms
- Holders can utilize inserts with different pitches and thread forms
- Repeatability is achieved by both the bolt-in style and the pin style locking systems
- Increase tool life by 25 - 50% with Allied Machine's AM210® coating
- Products
  - AccuThread™ 856: Bolt-in Style
  - AccuThread™ 856: Pin Style

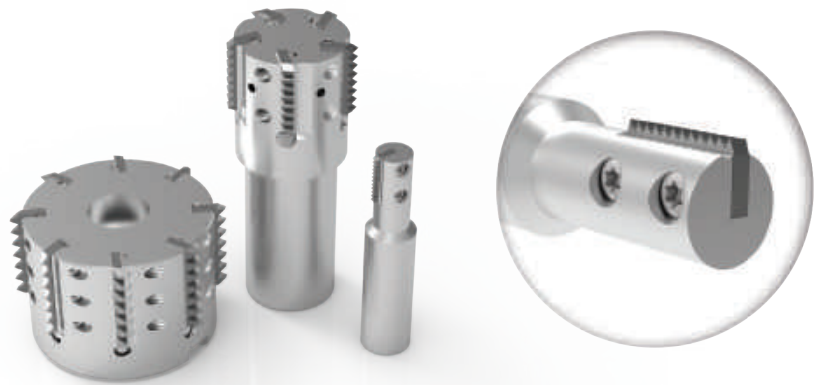

## SPECIAL CAPABILITIES

When it comes to designing and developing special solutions for customers, Allied Machine is the top choice. If your application requires special tooling, give us a call. Our engineered specials are developed by the brightest engineers in the industry. Most of our standard tooling can be altered as specials, or we can create entirely new concepts for particularly unique applications.

One special tooling solution is Insta-Quote®, the online system that allows you to design your own special tooling 24/7. Receive a quote and drawings within minutes just by following the steps.

And with the addition of Superior® technology and capabilities, we can customize made-to-order solid carbide tools to achieve optimal results for your applications.

Whatever your application, Allied Machine has the answer.



Insta-Quote® 



 SUPERION®



## Customer Support

### Support You Can Count On

Allied Machine has many lines of support to ensure we're available to assist you at all times. It's important to establish relationships with new customers, but we also know it's equally important to strengthen and support relationships with existing customers. Whether you need help with an order or you need someone to come assist you at the spindle, we have the right people to get you what you need.



1

#### Inside Sales Support

Our Inside Sales team is trained to handle your account information and general inquiries. We are happy to assist you and find the answers to your questions.

- ☎ 1.330.343.4283 ext. 8610
- ☎ 1.800.321.5537 (toll free United States and Canada)
- ✉ insidesales@alliedmachine.com

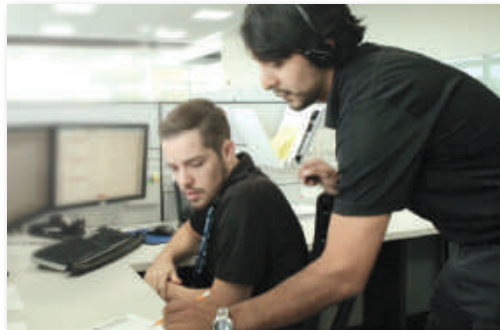

2

#### Engineering Support

Our highly trained and skilled Application Engineers (AEs) are here to assist you. If you are experiencing technical difficulties, our engineers will recommend the best solutions to the problem. Speeds and feeds, coolant pressure, and other machining components all affect the performance of our tooling. Our AEs are experienced in working with difficult materials in many different environments. Give us a call and put our knowledge to the test.

- ☎ 1.330.343.4283 ext. 7611
- ☎ 1.800.321.5537 (toll free United States and Canada)
- ✉ appeng@alliedmachine.com

3

#### Field Support

Allied Machine provides local engineering support all over the world. Our Field Sales Engineers (FSEs) spend months training in-house before going to the field. This support line allows us to provide assistance to our customers right at the spindle. They are available to visit your facility, run demos and tests, and work hand-in-hand with machine operators and engineers to find the best possible tooling solutions.

NOTE: If you do not know your local FSE, please contact us

- ☎ 1.330.343.4283
- ☎ 1.800.321.5537 (toll free United States and Canada)
- ✉ info@alliedmachine.com



A DRILLING  
B BORING  
C REAMING  
D BURNISHING  
E THREADING  
X SPECIALS

## Customer Training

### An Opportunity You Don't Want to Miss

Allied Machine's Technical Education Seminar (TES) puts the attendees in front of the machines. When you attend TES, you'll gain first-hand experience in real-life application situations. Test and experiment with different speeds and feeds, observe the results, and discover the best solution.

The training is conducted by Allied's skilled engineers, giving you the opportunity to work alongside the people who have the answers for all your application problems. You will also take guided tours of Allied Machine's two manufacturing facilities in Dover, Ohio.

# TES

Technical Education Seminar



Register online today:

[www.alliedmachine.com/TES](http://www.alliedmachine.com/TES)



### Training Lab

- In-depth training at the spindle allows you to choose the speeds and feeds
- Test the products the way you need to in order to discover the potential and the limitations in various applications
- Work side-by-side with Allied Machine's training technicians and engineers
- Witness the action of your tests and see the results up close

### Learning Lab

- Quick, brief sessions in Allied Machine's learning lab provide basic knowledge to get you acclimated with the products
- Interact with Application Engineers and discuss specific issues you're experiencing in your applications
- Gain confidence and take your Allied Machine product knowledge to the next level with TES sessions in the training lab



### Facility Tours

- Take guided tours of Allied Machine's two manufacturing facilities located in Dover, Ohio
- Follow the path of production and see the different steps and processes involved in the manufacturing of Allied Machine products
- See the magnitude of our capabilities and learn what's in store for the future



Allied Machine  
Training Facility  
485 West 3rd Street  
Dover, OH 44622

# Navigating the Catalog

A DRILLING  
B BORING  
C REAMING  
D BURNISHING  
E THREADING  
X SPECIALS

## Category Identifier

This indicates the specific category within the section. For example, T-A® products are broken into series from Y to 8, so the Category Identifier will indicate which series you are viewing.

## Application Identifier

The tabs along the side will help guide you to products designed for different application processes.

## Imperial / Metric Identifier

These symbols will appear in the tables when it is necessary to distinguish between imperial items and metric items (most commonly noted on holders).

## Safety Warnings

The safety warnings/indicators (in the table below) will appear throughout the catalog to help protect you from operations that can potentially be harmful if not performed correctly.

For items that classify as deep hole applicable, a warning is displayed to inform the user of the potential risk and direct them to the deep hole drilling guidelines for that item.

## Navigation Icons

These icons will direct you to other relevant parts of the section/book. The icon reference list for each section is located on the contents page of each section.

## Section Identifier and Page Number

The letter (or letter/number combination) before the page number indicates which section you are in.

**NOTE:** Page numbers begin at 1 in each section.

1 DRILLING | T-A® Replaceable Insert Drilling System

DRILLING

### T-A Drill Insert Holders

1 Series | Straight Shank | ER Collet

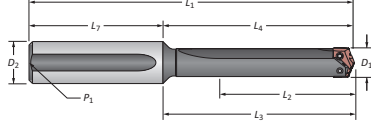
BORING

Series	Length	Body					Shank			Part No.
		D <sub>1</sub>	L <sub>2</sub>	L <sub>4</sub>	L <sub>3</sub>	L <sub>1</sub>	D <sub>2</sub>	L <sub>7</sub>	P <sub>1</sub>	
1	Short	45/64 - 15/16	2-5/8	3-7/8	4-1/64	6-7/8	3/4	3	1/8	22010S-075L
	Intermediate	45/64 - 15/16	4-5/8	5-7/8	6-1/64	8-7/8	1	3	1/8	23010S-100L
	Standard	45/64 - 15/16	6-5/8	7-7/8	8-1/64	10-7/8	3/4	3	1/8	24010S-075L
	Standard	45/64 - 15/16	6-5/8	7-7/8	8-1/64	10-7/8	1	3	1/8	24010S-100L
	Extended	45/64 - 15/16	10-5/8	11-7/8	12-1/64	14-7/8	1	3	1/8	25010S-100L
1.5	XL	45/64 - 15/16	18	19-1/4	19-25/64	22-1/4	1	3	1/8	27010S-100L
	3XL	45/64 - 15/16	22-1/4	23-1/2	23-41/64	26-1/2	1	3	1/8	29010S-100L
	Short	55/64 - 15/16	2-5/8	3-7/8	4-1/64	6-7/8	3/4	3	1/8*	22015S-075L
	Short	55/64 - 15/16	2-5/8	3-7/8	4-1/64	6-7/8	1	3	1/8*	22015S-100L
	Intermediate	55/64 - 15/16	4-5/8	5-7/8	6-1/64	8-7/8	1	3	1/8*	23015S-100L
Standard	Standard	55/64 - 15/16	6-5/8	7-7/8	8-1/64	10-7/8	3/4	3	1/8*	24015S-075L
	Standard	55/64 - 15/16	6-5/8	7-7/8	8-1/64	10-7/8	1	3	1/8*	24015S-100L
	Extended	55/64 - 15/16	10-5/8	11-7/8	12-1/64	14-7/8	1	3	1/8*	25015S-100L

REAMING

Series	Insert Screws	Nylon Locking Screws	Insert Driver	Preset Torque Hand Driver	Replacement Tips	Admissible Tightening Torque*
1	735-IP9-1	7375N-IP9-1	8IP-9	8IP-9TL	8IP-9B	27.0 in-lbs (300 N-cm)
1.5	739-IP9-1	739N-IP9-1	8IP-9	8IP-9TL	8IP-9B	27.0 in-lbs (300 N-cm)

BURNISHING

THREADING

SPECIALS

A30: 44-51    A30: 57 & 111



X

A30: 56

SPECIALS

SPECIALS

www.alliedmachine.com | 1.330.343.4283

**WARNING:** Refer to Speed and Feed charts for recommended adjustments to speeds and feeds. Refer to page A30: 350 for deep hole drilling guidelines in this section of the catalog. Visit [www.alliedmachine.com/deepholeguidelines.aspx](http://www.alliedmachine.com/deepholeguidelines.aspx) for the most up-to-date information and procedures. Factory technical assistance is available for your specific applications through our Application Engineering Team.

SPECIALS

Imperial (in)  
Metric (mm)

Screws sold in quantities of 10

## Safety Information

Your safety and the safety of others is very important. This catalog contains important safety messages. Always read and follow all safety precautions.



This triangle is a safety hazard symbol. It alerts you to potential safety hazards that can cause tool failure and serious injury.

When you see this symbol in the catalog, look for a related safety message that may be near this triangle or referred to in the nearby text.

There are safety signal words also used in the catalog. Safety messages follow these words.



**WARNING** (shown above) means that failure to follow the precautions in this message could result in tool failure and serious injury.

**NOTICE** means that failure to follow the precautions in this message could result in damage to the tool or machine but not result in personal injury.

**NOTE** and **IMPORTANT** are also used. These are important that you read and follow but are not safety-related.

Visit [www.alliedmachine.com](http://www.alliedmachine.com) for the most up-to-date information and procedures.

## Patent Information

Allied Machine & Engineering patent information can be found at [www.alliedmachine.com/patents](http://www.alliedmachine.com/patents)





**48 DRILLING | Revolution Drill® Large Diameter Replaceable IC Insert Drilling System**

**Revolution Drill Holders**  
48 Series | Diameter Range: 3.000" - 3.200" (76.2mm - 81.3mm)

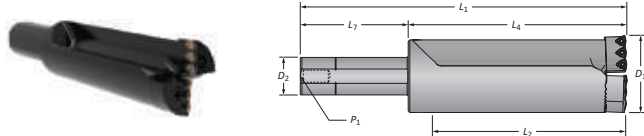

**Straight Shank**

Style	Length	D <sub>1</sub> Range	Holder			Shank			Part No.	Cartridges
			L <sub>2</sub>	L <sub>4</sub>	L <sub>1</sub>	D <sub>2</sub>	L <sub>3</sub>	P <sub>1</sub>		
Standard	1.0xD	3.000 - 3.200	3-5/32	4-33/64	9-1/64	2	4-1/2	1/4	R48X10-200L	C48...
Standard	2.5xD	3.000 - 3.200	7-29/32	9-17/64	13-49/64	2	4-1/2	1/4	R48X25-200L	C48...
Stacked Plate	1.0xD	3.000 - 3.200	3-15/64	4-19/32	9-3/32	2	4-1/2	1/4	SP48X10-200L	C48SP...
Stacked Plate	2.5xD	3.000 - 3.200	7-63/64	9-11/32	13-27/32	2	4-1/2	1/4	SP48X25-200L	C48SP...

**CV50 Shank**

Style	Length	D <sub>1</sub> Range	Holder		Shank	Part No.	Cartridges
			L <sub>2</sub>	L <sub>4</sub>			
Standard	1.0xD	76.2 - 81.3	80.2	114.5	50	R48X10-CV50M	C48...
Standard	2.5xD	76.2 - 81.3	200.9	235.2	50	R48X25-CV50M	C48...
Stacked Plate	1.0xD	76.2 - 81.3	82.2	116.5	50	SP48X10-CV50M	C48SP...
Stacked Plate	2.5xD	76.2 - 81.3	202.9	237.2	50	SP48X25-CV50M	C48SP...

**Cartridges**

Holder Part No.	Replacement Cartridges	Qty.	Inserts Needed	Mounting Screw	Adjusting Screw	Carbide Grade	Geometry	AM300®	AM200®	TIN	Insert Screws
R48...	C48-FIX	3	MS-21M-1	AS-18T9-1		CS (P35)	Standard	OP-05T308-P	OP-05T308-H	OP-05T308-T	IS-10-1
R48...	C48-ADJ	3	MS-21M-1	AS-18T9-1		C1 (K35)	Standard	OP-05T308-1P	OP-05T308-1H	OP-05T308-1T	IS-10-1
SP48...	C48SP-FIX	3	MS-21M-1	AS-18T9-1		C2 (K25)	Standard	OP-05T308-2P	OP-05T308-2H		IS-10-1
SP48...	C48SP-ADJ	3	MS-21M-1	AS-18T9-1		CS (P35)	High Rate	OP-05T308-PHR	OP-05T308-HHR		IS-10-1

**IC Inserts**

Mounting screws sold in multiples of 4 | Adjusting screws sold in multiples of 4  
IC inserts sold in multiples of 10 | Insert screws sold in multiples of 10  
⊕ = Imperial (in) ⊖ = Metric (mm)

www.alliedmachine.com | 1.330.343.4283

**Keeping Like Things Together**

The sections in this catalog have been organized to keep related items together. For example, Revolution Drill® holders, cartridges, inserts, assembly screws, and accessories are all listed together by series. Therefore, you won't need to flip back and forth between pages to find all the parts needed to build a complete tool.

However, there are some instances where like items are separated. For example, T-A® inserts are grouped together by series, immediately followed by the holders and accessories for the same series. In this situation, you will need to flip between inserts and holders, but all items will still be grouped together by series.

This is when the Navigation Icons come in handy.

48 Series Holders

48 Series Cartridges and Screws

Inserts and Screws

**You Can Find Your Item in the Index**

If you have an item number and you're looking for that item in the catalog, you can use the index located in the back of the catalog.















Index entries will reference the first part of the item number, which will direct you to the page where your item is listed.

**Example:** Your item number is R48X10-CV50. In the index, you will find "R48X10..." listed on page A60: 16, which is where items beginning with R48X10 can be found.

R44X35...	A60: 14
R46X22...	A60: 15
R46X35...	A60: 15
R48X10...	A60: 16
R48X25...	A60: 16
R52X10...	A60: 17
R52X25...	A60: 17

## Product Selection Guide

### Drilling

Product	Diameter Range (inch / mm)											
	0 - 0.5 0 - 12.7	0.5 - 1 12.7 - 25.4	1 - 1.5 25.4 - 38.1	1.5 - 2 38.1 - 50.8	2 - 2.5 50.8 - 63.5	2.5 - 3 63.5 - 76.2	3 - 3.5 76.2 - 88.9	3.5 - 4 88.9 - 101.6	4 - 4.5 101.6 - 114.3	4.5 - 5 114.3 - 127	5 - 5.5 127 - 139.7	5.5 - 6 + 139.7 - 152.4 +
ASC 320® 	0.1250 - 0.7874 (3.00 - 20.00)											
GEN3SYS® XT Pro 		0.4331 - 1.3780 (11.00 - 35.00)										
GEN3SYS® XT 		0.4331 - 1.3780 (11.00 - 35.00)										
T-A® GEN2 					0.3740 - 4.500 (9.50 - 114.30)							
T-A® 					0.3740 - 4.500 (9.50 - 114.30)							
High Performance 			0.9688 - 5.000 (24.60 - 127.00)									
Universal 			0.9688 - 8.500 (24.60 - 215.90)									
APX Drill 				1.4961 - 4.000 (38.00 - 101.6.30)								
Revolution Drill® 				1.8750 - 4.0000 (47.60 - 101.60)								
Opening Drill® 				2.0000 - 5.6200 (50.80 - 142.80)								
Structural Steel: GEN3SYS® XT Pro 		0.4331 - 1.3780 (11.00 - 35.00)										
Structural Steel: T-A® 			0.5110 - 1.8820 (12.98 - 47.80)									
AccuPort 432® 		0.3860 - 2.4210 (9.80 - 61.50)										
BT-A Drill 		0.5100 - 1.8820 (12.95 - 47.80)										

▶ Any product line with a black arrow indicates that larger non-standard diameters can be ordered by contacting Application Engineering:  
 ☎ 1.330.343.4283 ext. 7611 ☎ 1.800.321.5537 (toll free United States and Canada) ✉ appeng@alliedmachine.com



### Online Product Selector

Have an application in your sights? You can utilize our Product Selector online to find the right tool for the job. Product Selector will provide run time parameters along with detailed information about the item(s) you need. Visit [www.alliedmachine.com/ProductSelector](http://www.alliedmachine.com/ProductSelector) to get started.

Length to Diameter Ratio	Machining Application					Material						Section
	General Purpose	High Penetration	Deep Hole	Large Diameter	Industry Specific	P	S	M	H	K	N	
3.5xD, 6xD, 9xD	●	●	○			●	●	●		●	●	A10
Stub, 3xD, 5xD, 7xD, 10xD	●	●	●			●				●	●	A20
Stub, 3xD, 5xD, 7xD	●	●				●	●	●	○	●	●	A20
1xD to 28xD	●	○	●	●		●	●	●		●	●	A30
1xD to 28xD	●	○	●	●		●	●	●	●	●	●	A30
	●		●	●		●	○	●		○	●	A40
	●		●	●		○	○	○		○	○	A40
3xD, 5xD, 8xD, 10xD	●		●	●		●	○	●		●	●	A50
1xD, 2.2xD, 2.5xD, 3.5xD, 4.5xD,	○	●		●		●		●	○	●	●	A60
	○	●		●		●		●	○	●	●	A70
3xD, 5xD, 7xD		○	●		●	●						A91
2xD, 4xD, 5xD, 6xD	○				●	●						A91
					●	●		○		●	●	A92
		●	●		●	●	○	○		●	●	A93

● Best   ● Better   ○ Good

A DRILLING  
B BORING  
C REAMING  
D BURNISHING  
E THREADING  
X SPECIALS



**Increase the production and success of your applications today.**

- Direct access to 2D drawings and 3D models
- Assemble and view tool images in your browser
- Download drawings for use in most machining software programs
- Browse products, search item numbers, and save assemblies for future use

[toolmd.com](http://toolmd.com)

## WOHLHAUPTER® Tool-Architect

**Find the right Wohlhaupter™ solution for your application.**

- Configure your complete tool assembly
- Compile an order list to be quoted
- Search and quickly find components using various criteria
- Adjust your language and measurement preferences



[tool-architect.com](http://tool-architect.com)

## WOHLHAUPTER® Boring Insert Selector

**Find the best insert for your application.**

- Generate the correct boring insert for your job in just six easy steps
- Choose type, shape, substrate, insert form, nose radius, and material
- Easily order by adding the item to your cart



[alliedmachine.com/bis](http://alliedmachine.com/bis)

## Product Selector

**Use the product selector to find the right tool for your application.**

- Follow guided you through steps to generate the right tool for your application
- Learn about your recommended tool and how to maximize its performance



[alliedmachine.com/productselector](http://alliedmachine.com/productselector)

A DRILLING  
B BORING  
C REAMING  
D BURNISHING  
E THREADING  
X SPECIALS

# Insta-Code®

**Eliminate the wait. Get your program now.**

- Choose the best thread mill for your application
- Create program code for your machine
- Available as a PC download app (that can be used offline)
- Website app available 24/7



Insta-Code also has a **Cycle Time Calculator**

[alliedmachine.com/InstaCode](http://alliedmachine.com/InstaCode)

# Insta-Quote®

**Design your custom tooling and receive a drawing and quote...all within minutes.**

- Design and quote your own tooling
- Generate the solution you need in just a few steps
- Features the following products
  - T-A® Inserts
  - T-A® Holders
  - GEN3SYS® XT Holders
  - ALVAN® Reamers

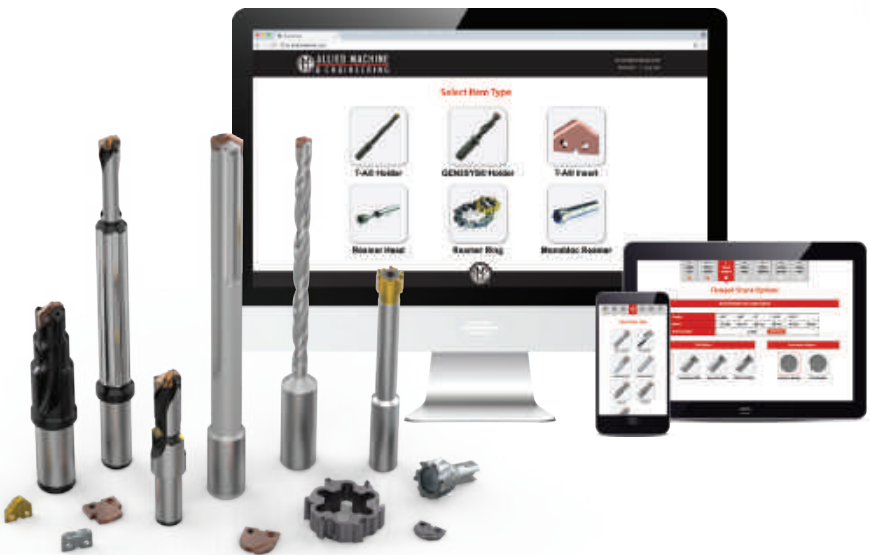

[iq.alliedmachine.com](http://iq.alliedmachine.com)

## Solution Hub App

**All Allied all the time.**

- Quickly look up product information
- Links to our free online tools
- Locate distributors
- Stay up to date on news and events



## Machinist Tool App

**Quickly convert cutting tool parameters for the machine inputs you need.**

- Input data to calculate the RPM and speed and feed rates
- Use the Boring Insert Selector
- Access product literature right at your fingertips





SECTION

---

# A10

---

ASC 320®

# ASC 320®

## High Penetration Solid Carbide Drilling System

▶ **Diameter Range:** 0.1181" - 0.7874" (3.00mm - 20.00mm)



### Beyond the Cutting Edge

The ASC 320 range of solid carbide high penetration drills has been specifically engineered to deliver high productivity in difficult-to-machine materials, including stainless steels, Inconel, Hastelloy, and Titanium.

The unique combination of cutting edge geometry and high performance coatings provides excellent chip control, hole quality, and extended tool life, making ASC 320 ideal for use in a wide range of challenging applications and market sectors.

Extended tool life	3.5xD, 6xD, and 9xD	Excellent chip control
--------------------	---------------------	------------------------

### Applicable Industries



Aerospace



Agriculture



Automotive



Firearms



General  
Machining



Oil & Gas



Renewable  
Energy

Your safety and the safety of others is very important. This catalog contains important safety messages. Always read and follow all safety precautions.



This triangle is a safety hazard symbol. It alerts you to potential safety hazards that can cause tool failure and serious injury.

When you see this symbol in the catalog, look for a related safety message that may be near this triangle or referred to in the nearby text.

There are safety signal words also used in the catalog. Safety messages follow these words.

#### **WARNING**

**WARNING** (shown above) means that failure to follow the precautions in this message could result in tool failure and serious injury.

**NOTICE** means that failure to follow the precautions in this message could result in damage to the tool or machine but not result in personal injury.

**NOTE** and **IMPORTANT** are also used. These are important that you read and follow but are not safety-related.

Visit [www.alliedmachine.com](http://www.alliedmachine.com) for the most up-to-date information and procedures.



## Reference Icons

The following icons will appear throughout the catalog to help you navigate between products.



### Setup / Assembly Information

Detailed instructions and information regarding the corresponding part(s)

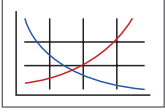

### Recommended Cutting Data

Speed and feed recommendations for optimum and safe drilling

## Introduction Information

Product Overview . . . . .	2
Item Number Nomenclature . . . . .	3

## Drill Length

3.5xD . . . . .	4 - 5
6xD . . . . .	6 - 9
9xD . . . . .	10 - 11

## Recommended Cutting Data

Imperial (inch) . . . . .	12
Metric (mm) . . . . .	13
Coolant Recommendations . . . . .	14

Product Overview

The Advantages

- ✓ **Ideal for a wide variety of applications**  
with the unique geometry and coating combination
- ✓ **Increased stability**  
with the reinforced shank
- ✓ **Increased tool life**
- ✓ **Excellent chip control**
- ✓ **Through coolant design**
- ✓ **Available in 3.5xD, 6xD, and 9xD lengths**

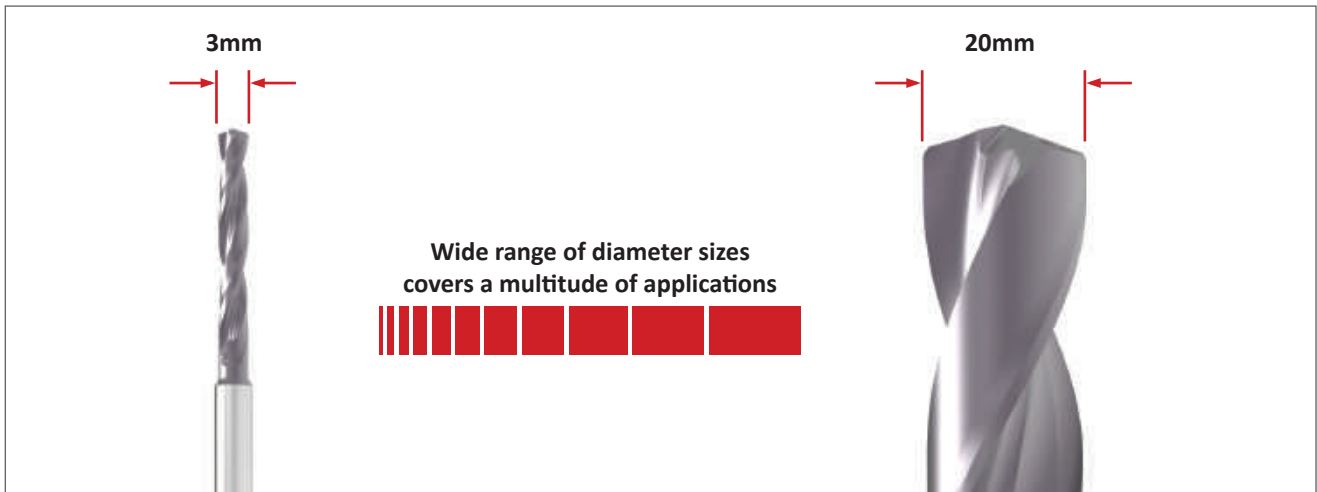

<b>P</b> Steel N/mm <sup>2</sup> <1365	<b>S</b> High Temp Materials N/mm <sup>2</sup> <1365	<b>M</b> Stainless Steel N/mm <sup>2</sup> <940	<b>H</b> Hardened Materials N/mm <sup>2</sup> <1365	<b>K</b> Cast and Ductile Iron N/mm <sup>2</sup> <1020	<b>N</b> Non-Ferrous Materials N/mm <sup>2</sup> <855
◆	◆	◆	❖	❖	❖

◆ First choice  
❖ Second choice

A DRILLING B BORING C REAMING D BURNISHING E THREADING X SPECIALS

## Product Nomenclature

### ASC 320 Solid Carbide Drills

<b>3</b>	<b>60</b>	<b>M</b>	<b>07500</b>	<b>A21</b>	<b>M</b>
1	2	3	4	5	6

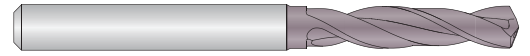

1. ASC 320®	2. Length	3. Style	4. Diameter	5. Substrate Geometry	6. Multi-Layer Coating
<b>3</b> = Solid carbide	<b>35</b> = 3.5xD <b>60</b> = 6xD <b>90</b> = 9xD	<b>E</b> = English (Imperial)  <b>M</b> = Metric	<b>07500</b> = 0.7500"	<b>A21</b> = Standard	<b>M</b> = TiAlN

#### Regrind and Recoating

The ASC 320 drills are ground and recoated by Allied Machine to maintain the high level of performance achieved with these tools. Using our services assures the best tool performance is maintained in your production process.

#### Reference Key

Symbol	Attribute
$D_1$	Drill diameter
$D_2$	Shank diameter
$L_1$	Overall length
$L_2$	Drill depth
$L_7$	Shank length

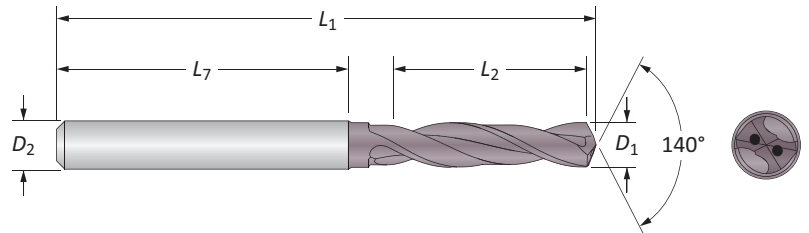

A

DRILLING

B

BORING

C

REAMING

D

BURNISHING

E

THREADING

X

SPECIALS

Solid Carbide Drills

3.5xD | Diameter Range: 0.1181" - 0.7874" (3.00mm - 20.00mm)

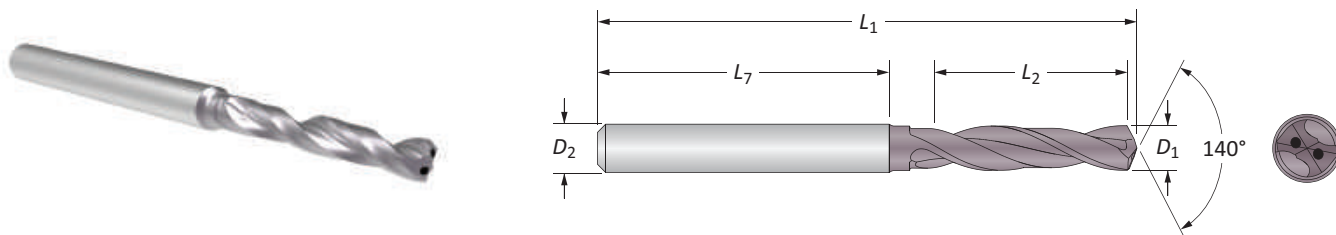

Fractional Equivalent	D <sub>1</sub>		Tap Size*	Body				Shank		Part No.
	inch	mm		L <sub>2</sub> inch	L <sub>2</sub> mm	L <sub>1</sub> inch	L <sub>1</sub> mm	L <sub>7</sub> mm	D <sub>2</sub> mm	
1/8	0.1250	3.17	-	0.551	14	2.47	62.7	36	4	335E01250A21M
-	0.1575	4.00	-	0.551	14	2.47	62.7	36	4	335M04000A21M
-	0.1654	4.20	M5x0.8	0.827	21	2.64	67.1	36	6	335M04200A21M
11/64	0.1719	4.37	-	0.827	21	2.64	67.1	36	6	335E01719A21M
#16	0.1772	4.50	#12-24	0.827	21	2.64	67.1	36	6	335M04500A21M
-	0.1811	4.60	#12-28	0.827	21	2.64	67.1	36	6	335M04600A21M
3/16	0.1875	4.76	-	0.827	21	2.64	67.1	36	6	335E01875A21M
-	0.1969	5.00	M6x1	0.827	21	2.64	67.1	36	6	335M05000A21M
13/64	0.2031	5.16	-	0.827	21	2.64	67.1	36	6	335E02031A21M
7/32	0.2188	5.56	-	0.827	21	2.64	67.1	36	6	335E02188A21M
#1	0.2280	5.79	-	0.827	21	2.64	67.1	36	6	335E02280A21M
15/64	0.2344	5.95	-	0.827	21	2.64	67.1	36	6	335E02344A21M
-	0.2362	6.00	M7x1	0.827	21	2.64	67.1	36	6	335M06000A21M
1/4	0.2500	6.35	-	1.102	28	3.13	79.4	36	8	335E02500A21M
-	0.2559	6.50	-	1.102	28	3.13	79.4	36	8	335M06500A21M
17/64	0.2656	6.75	M8x1.25	1.102	28	3.13	79.4	36	8	335E02656A21M
-	0.2756	7.00	M8x1	1.102	28	3.13	79.4	36	8	335M07000A21M
9/32	0.2812	7.14	-	1.102	28	3.13	79.4	36	8	335E02812A21M
-	0.2874	7.30	-	1.102	28	3.13	79.4	36	8	335M07300A21M
-	0.2953	7.50	-	1.102	28	3.13	79.4	36	8	335M07500A21M
19/64	0.2969	7.54	-	1.102	28	3.13	79.4	36	8	335E02969A21M
-	0.3071	7.80	-	1.102	28	3.13	79.4	36	8	335M07800A21M
5/16	0.3125	7.94	3/8-16	1.102	28	3.13	79.4	36	8	335E03125A21M
-	0.3150	8.00	-	1.102	28	3.13	79.4	36	8	335M08000A21M
21/64	0.3281	8.33	-	1.378	35	3.57	90.7	40	10	335E03281A21M
Q	0.3320	8.43	3/8-24	1.378	35	3.57	90.7	40	10	335E03320A21M
-	0.3346	8.50	M10.1.5	1.378	35	3.57	90.7	40	10	335M08500A21M
11/32	0.3438	8.73	-	1.378	35	3.57	90.7	40	10	335E03438A21M
-	0.3465	8.80	-	1.378	35	3.57	90.7	40	10	335M08800A21M
-	0.3543	9.00	-	1.378	35	3.57	90.7	40	10	335M09000A21M
23/64	0.3594	9.13	-	1.378	35	3.57	90.7	40	10	335E03594A21M
U	0.3680	9.35	7/16-14	1.378	35	3.57	90.7	40	10	335E03680A21M
-	0.3740	9.50	-	1.378	35	3.57	90.7	40	10	335M09500A21M
3/8	0.3750	9.53	-	1.378	35	3.57	90.7	40	10	335E03750A21M
-	0.3858	9.80	-	1.378	35	3.57	90.7	40	10	335E03858A21M
25/64	0.3906	9.92	7/16-20	1.378	35	3.57	90.7	40	10	335E03906A21M
-	0.3937	10.00	-	1.378	35	3.57	90.7	40	10	335M10000A21M

\*Tap drill diameters allow approximately 75% of full thread to be produced

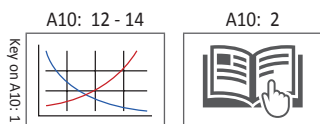

Sizes not shown are available as non-stocked standards. When ordering, please follow the examples shown below:

<b>Inch</b>	Diameter needed = 0.3450"	Part No. = 335E03450A21M
<b>Metric</b>	Diameter needed = 7.250mm	Part No. = 335M07250A21M

Solid Carbide Drills

3.5xD | Diameter Range: 0.1181" - 0.7874" (3.00mm - 20.00mm)

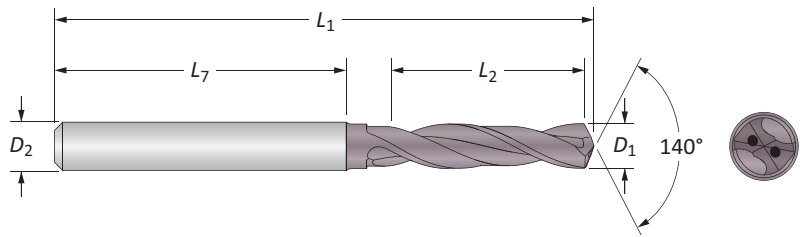

Fractional Equivalent	D <sub>1</sub>		Tap Size*	Body				Shank		Part No.
	inch	mm		L <sub>2</sub> inch	L <sub>2</sub> mm	L <sub>1</sub> inch	L <sub>1</sub> mm	L <sub>7</sub> mm	D <sub>2</sub> mm	
-	0.4016	10.20	M12x1.75	1.654	42	4.18	106.1	45	12	335M10200A21M
13/32	0.4062	10.32	-	1.378	42	4.18	106.1	45	12	335E04062A21M
-	0.4134	10.50	-	1.378	42	4.18	106.1	45	12	335M10500A21M
27/64	0.4219	10.72	1/2-13	1.654	42	4.18	106.1	45	12	335E04219A21M
-	0.4331	11.00	-	1.654	42	4.18	106.1	45	12	335M11000A21M
7/16	0.4375	11.11	-	1.654	42	4.18	106.1	45	12	335E04375A21M
-	0.4528	11.50	-	1.654	42	4.18	106.1	45	12	335M11500A21M
29/64	0.4531	11.51	1/2-20	1.654	42	4.18	106.1	45	12	335E04531A21M
15/32	0.4688	11.91	-	1.654	42	4.18	106.1	45	12	335E04688A21M
-	0.4724	12.00	M14x2	1.654	42	4.18	106.1	45	12	335M12000A21M
31/64	0.4844	12.30	9/16-12	1.929	49	4.55	115.6	45	14	335E04844A21M
-	0.4921	12.50	M14x1.5	1.929	49	4.55	115.6	45	14	335M12500A21M
1/2	0.5000	12.70	-	1.929	49	4.55	115.6	45	14	335E05000A21M
-	0.5118	13.00	-	1.929	49	4.55	115.6	45	14	335M13000A21M
33/64	0.5156	13.10	9/16-18	1.929	49	4.55	115.6	45	14	335E05156A21M
17/32	0.5312	13.49	5/8-11	1.929	49	4.55	115.6	45	14	335E05312A21M
-	0.5315	13.50	-	1.929	49	4.55	115.6	45	14	335M13500A21M
-	0.5394	13.70	-	1.929	49	4.55	115.6	45	14	335M13700A21M
35/64	0.5469	13.89	5/8-12	1.929	49	4.55	115.6	45	14	335E05469A21M
-	0.5512	14.00	M16x2	1.929	49	4.55	115.6	45	14	335M14000A21M
9/16	0.5625	14.29	-	2.205	56	5.07	128.8	48	16	335E05625A21M
-	0.5709	14.50	M16x1.5	2.205	56	5.07	128.8	48	16	335M14500A21M
37/64	0.5781	14.68	5/8-18	2.205	56	5.07	128.8	48	16	335E05781A21M
-	0.5906	15.00	-	2.205	56	5.07	128.8	48	16	335M15000A21M
19/32	0.5938	15.08	-	2.205	56	5.07	128.8	48	16	335E05938A21M
39/64	0.6094	15.48	11/16-12	2.205	56	5.07	128.8	48	16	335E06094A21M
-	0.6102	15.50	M18x2.5	2.205	56	5.07	128.8	48	16	335M15500A21M
5/8	0.6250	15.88	-	2.205	56	5.07	128.8	48	16	335E06250A21M
-	0.6299	16.00	-	2.205	56	5.07	128.8	48	16	335M16000A21M
-	0.6496	16.50	M18x1.5	2.480	63	5.44	138.2	48	18	335M16500A21M
21/32	0.6563	16.67	3/4-10	2.480	63	5.44	138.2	48	18	335E06563A21M
-	0.6693	17.00	-	2.480	63	5.44	138.2	48	18	335M17000A21M
43/64	0.6719	17.07	3/4-12	2.480	63	5.44	138.2	48	18	335E06719A21M
11/16	0.6875	17.46	3/4-16	2.480	63	5.44	138.2	48	18	335E06875A21M
-	0.6890	17.50	M20x2.5	2.480	63	5.44	138.2	48	18	335M17500A21M
45/64	0.7031	17.86	-	2.480	63	5.44	138.2	48	18	335E07031A21M
-	0.7087	18.00	-	2.480	63	5.44	138.2	48	18	335M18000A21M
-	0.7283	18.50	M20x1.5	2.756	70	5.89	149.5	50	20	335M18500A21M
47/64	0.7344	18.65	-	2.756	70	5.89	149.5	50	20	335E07344A21M
-	0.7480	19.00	-	2.756	70	5.89	149.5	50	20	335M19000A21M
-	0.7580	19.25	-	2.756	70	5.89	149.5	50	20	335E07580A21M
-	0.7677	19.50	M22x2.5	2.756	70	5.89	149.5	50	20	335M19500A21M
25/32	0.7813	19.84	-	2.756	70	5.89	149.5	50	20	335E07813A21M
-	0.7874	20.00	-	2.756	70	5.89	149.5	50	20	335M20000A21M

\*Tap drill diameters allow approximately 75% of full thread to be produced

Sizes not shown are available as non-stocked standards. When ordering, please follow the examples shown below:

Inch	Diameter needed = 0.3450"	Part No. = 335E03450A21M
Metric	Diameter needed = 7.250mm	Part No. = 335M07250A21M

A10: 12 - 14

A10: 2

A DRILLING  
B BORING  
C REAMING  
D BURNISHING  
E THREADING  
X SPECIALS

## Solid Carbide Drills

6xD | Diameter Range: 0.1181" - 0.7874" (3.00mm - 20.00mm)

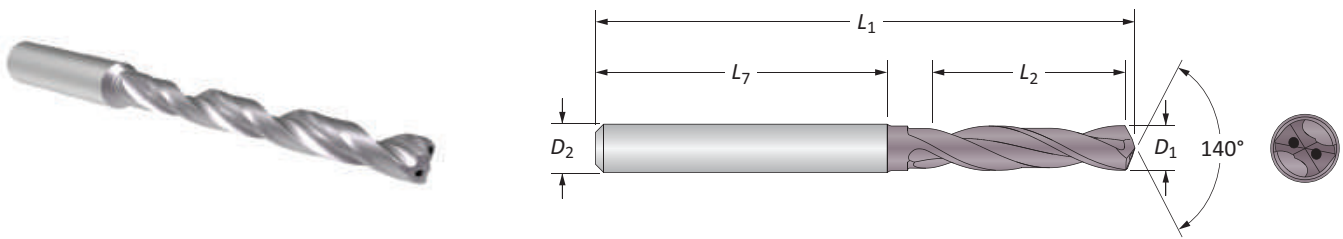

Fractional Equivalent	D <sub>1</sub>		Tap Size*	Body				Shank		Part No.
	inch	mm		L <sub>2</sub> inch	L <sub>2</sub> mm	L <sub>1</sub> inch	L <sub>1</sub> mm	L <sub>7</sub> mm	D <sub>2</sub> mm	
-	0.1181	3.00	-	0.9450	24	2.86	72.7	36	4	360M03000A21M
1/8	0.1250	3.18	-	0.9450	24	2.86	72.7	36	4	360E01250A21M
-	0.1260	3.20	-	0.9450	24	2.86	72.7	36	4	360M03200A21M
-	0.1299	3.30	M4x0.7	0.9450	24	2.86	72.7	36	4	360M03300A21M
-	0.1378	3.50	-	0.9450	24	2.86	72.7	36	4	360M03500A21M
9/64	0.1406	3.57	-	0.9450	24	2.86	72.7	36	4	360E01406A21M
#25	0.1496	3.80	#10-24	0.9450	24	2.86	72.7	36	4	360M03800A21M
5/32	0.1563	3.97	-	0.9450	24	2.86	72.7	36	4	360E01563A21M
-	0.1575	4.00	-	0.9450	24	2.86	72.7	36	4	360M04000A21M
-	0.1654	4.20	M5x0.8	1.1417	36	3.27	83.1	36	6	360M04200A21M
11/64	0.1719	4.37	-	1.1417	36	3.27	83.1	36	6	360E01719A21M
#16	0.1772	4.50	#12-24	1.1417	36	3.27	83.1	36	6	360M04500A21M
-	0.1811	4.60	#12-28	1.1417	36	3.27	83.1	36	6	360M04600A21M
-	0.1831	4.65	-	1.1417	36	3.27	83.1	36	6	360M04650A21M
3/16	0.1875	4.76	-	1.1417	36	3.27	83.1	36	6	360E01875A21M
-	0.1950	4.95	-	1.1417	36	3.27	83.1	36	6	360M04950A21M
-	0.1969	5.00	M6x1	1.1417	36	3.27	83.1	36	6	360M05000A21M
#8	0.1990	5.05	-	1.1417	36	3.27	83.1	36	6	360E01990A21M
#7	0.2010	5.11	1/4-20	1.1417	36	3.27	83.1	36	6	360E02010A21M
13/64	0.2031	5.16	-	1.1417	36	3.27	83.1	36	6	360E02031A21M
-	0.2098	5.33	-	1.1417	36	3.27	83.1	36	6	360M05330A21M
#3	0.2130	5.41	1/4-28	1.1417	36	3.27	83.1	36	6	360E02130A21M
-	0.2165	5.50	-	1.1417	36	3.27	83.1	36	6	360M05500A21M
7/32	0.2188	5.56	-	1.1417	36	3.27	83.1	36	6	360E02188A21M
#1	0.2280	5.79	-	1.1417	36	3.27	83.1	36	6	360E02280A21M
-	0.2299	5.84	-	1.1417	36	3.27	83.1	36	6	360M05840A21M
15/64	0.2344	5.95	-	1.1417	36	3.27	83.1	36	6	360E02344A21M
-	0.2362	6.00	M7x1	1.1417	36	3.27	83.1	36	6	360M06000A21M

\*Tap drill diameters allow approximately 75% of full thread to be produced

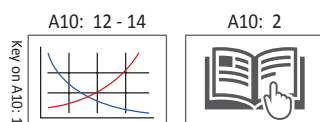

Sizes not shown are available as non-stocked standards.

When ordering, please follow the examples shown below:

<b>Inch</b>	Diameter needed = 0.3450"	Part No. = 335E <b>03450</b> A21M
<b>Metric</b>	Diameter needed = 7.250mm	Part No. = 335M <b>07250</b> A21M

Solid Carbide Drills

6xD | Diameter Range: 0.1181" - 0.7874" (3.00mm - 20.00mm)

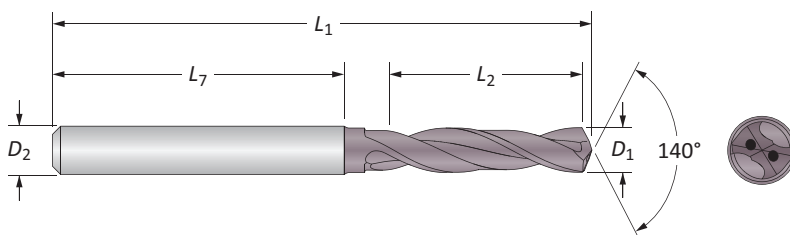

Fractional Equivalent	D <sub>1</sub>		Tap Size*	Body				Shank		Part No.
	inch	mm		L <sub>2</sub> inch	L <sub>2</sub> mm	L <sub>1</sub> inch	L <sub>1</sub> mm	L <sub>7</sub> mm	D <sub>2</sub> mm	
-	0.2398	6.09	-	1.8900	48	4.31	109.4	36	8	360M06090A21M
D	0.2460	6.25	-	1.8900	48	4.31	109.4	36	8	360E02460A21M
1/4	0.2500	6.35	-	1.8900	48	4.31	109.4	36	8	360E02500A21M
-	0.2559	6.50	-	1.8900	48	4.31	109.4	36	8	360M06500A21M
F	0.2570	6.53	5/16-18	1.8900	48	4.31	109.4	36	8	360E02570A21M
17/64	0.2656	6.75	M8x1.25	1.8900	48	4.31	109.4	36	8	360E02656A21M
-	0.2677	6.80	-	1.8900	48	4.31	109.4	36	8	360M06800A21M
I	0.2720	6.91	5/16-24	1.8900	48	4.31	109.4	36	8	360E02720A21M
-	0.2756	7.00	M8x1	1.8900	48	4.31	109.4	36	8	360M07000A21M
-	0.2795	7.10	-	1.8900	48	4.31	109.4	36	8	360M07100A21M
9/32	0.2812	7.14	-	1.8900	48	4.31	109.4	36	8	360E02812A21M
-	0.2874	7.30	-	1.8900	48	4.31	109.4	36	8	360M07300A21M
-	0.2913	7.40	-	1.8900	48	4.31	109.4	36	8	360M07400A21M
-	0.2953	7.50	-	1.890	48	4.31	109.4	36	8	360M07500A21M
19/64	0.2969	7.54	-	1.890	48	4.31	109.4	36	8	360E02969A21M
5/16	0.3125	7.94	3/8-16	1.890	48	4.31	109.4	36	8	360E03125A21M
-	0.3150	8.00	-	1.890	48	4.31	109.4	36	8	360M08000A21M
21/64	0.3281	8.33	-	2.362	60	4.56	115.4	40	10	360E03281A21M
Q	0.3320	8.43	3/8-24	2.362	60	4.56	115.4	40	10	360M08430A21M
-	0.3346	8.50	M10x1.5	2.362	60	4.56	115.4	40	10	360M08500A21M
-	0.3386	8.60	-	2.362	60	4.56	115.4	40	10	360M08600A21M
11/32	0.3438	8.73	-	2.362	60	4.56	115.4	40	10	360E03438A21M
-	0.3465	8.80	-	2.362	60	4.56	115.4	40	10	360M08800A21M
-	0.3543	9.00	-	2.362	60	4.56	115.4	40	10	360M09000A21M
23/64	0.3594	9.13	-	2.362	60	4.56	115.4	40	10	360E03594A21M
-	0.3622	9.20	-	2.362	60	4.56	115.4	40	10	360M09200A21M
U	0.3680	9.35	7/16-14	2.362	60	4.56	115.4	40	10	360E03680A21M
-	0.3730	9.47	-	2.362	60	4.56	115.4	40	10	360M09470A21M
-	0.3740	9.50	-	2.362	60	4.56	115.4	40	10	360M09500A21M
3/8	0.3750	9.53	-	2.362	60	4.56	115.4	40	10	360E03750A21M
-	0.3780	9.60	-	2.362	60	4.56	115.4	40	10	360M09600A21M
-	0.3820	9.70	-	2.362	60	4.56	115.4	40	10	360M09700A21M
25/64	0.3906	9.92	7/16-20	2.362	60	4.56	115.4	40	10	360E03906A21M
-	0.3937	10.00	-	2.362	60	4.56	115.4	40	10	360M10000A21M

\*Tap drill diameters allow approximately 75% of full thread to be produced

A

DRILLING

B

BORING

C

REAMING

D

BURNISHING

E

THREADING

X

SPECIALS

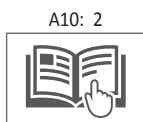
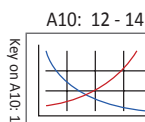

Sizes not shown are available as non-stocked standards. When ordering, please follow the examples shown below:

Inch	Diameter needed = 0.3450"	Part No. = 335E03450A21M
Metric	Diameter needed = 7.250mm	Part No. = 335M07250A21M

## Solid Carbide Drills

6xD | Diameter Range: 0.1181" - 0.7874" (3.00mm - 20.00mm)

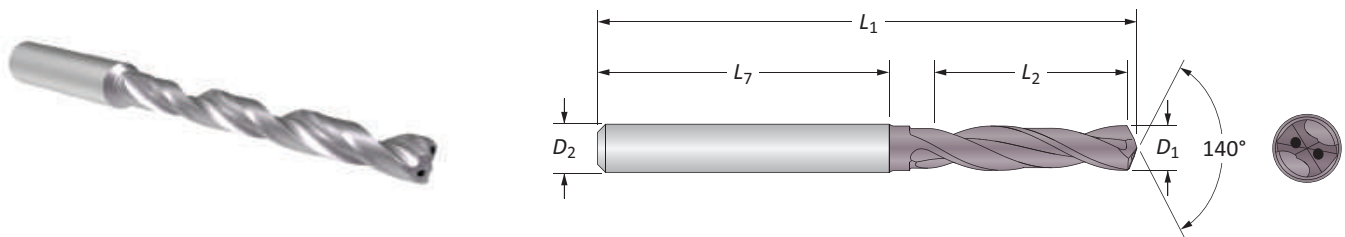

Fractional Equivalent	D <sub>1</sub>		Tap Size*	Body				Shank		Part No.
	inch	mm		L <sub>2</sub> inch	L <sub>2</sub> mm	L <sub>1</sub> inch	L <sub>1</sub> mm	L <sub>7</sub> mm	D <sub>2</sub> mm	
-	0.4016	10.20	M12x1.75	2.835	72	5.36	136.2	45	12	360M10200A21M
Y	0.4040	10.31	-	2.835	72	5.36	136.2	45	12	360E04040A21M
13/32	0.4062	10.32	-	2.835	72	5.36	136.2	45	12	360E04062A21M
-	0.4134	10.50	-	2.835	72	5.36	136.2	45	12	360M10500A21M
27/64	0.4219	10.72	1/2-13	2.835	72	5.36	136.2	45	12	360E04219A21M
-	0.4252	10.80	M12x4.25	2.835	72	5.36	136.2	45	12	360M10800A21M
-	0.4290	10.90	-	2.835	72	5.36	136.2	45	12	360M10900A21M
-	0.4331	11.00	-	2.835	72	5.36	136.2	45	12	360M11000A21M
7/16	0.4375	11.11	-	2.835	72	5.36	136.2	45	12	360E04375A21M
-	0.4409	11.20	-	2.835	72	5.36	136.2	45	12	360M11200A21M
-	0.4528	11.50	-	2.835	72	5.36	136.2	45	12	360M11500A21M
29/64	0.4531	11.51	1/2-20	2.835	72	5.36	136.2	45	12	360E04531A21M
-	0.4646	11.80	-	2.835	72	5.36	136.2	45	12	360M11800A21M
15/32	0.4688	11.91	-	2.835	72	5.36	136.2	45	12	360E04688A21M
-	0.4724	12.00	M14x2	2.835	72	5.36	136.2	45	12	360M12000A21M
31/64	0.4844	12.30	9/16-12	3.307	84	5.93	150.5	45	14	360E04844A21M
-	0.4921	12.50	M14x1.5	3.307	84	5.93	150.5	45	14	360M12500A21M
1/2	0.5000	12.70	-	3.307	84	5.93	150.5	45	14	360E05000A21M
-	0.5100	12.95	-	3.307	84	5.93	150.5	45	14	360M12950A21M
-	0.5118	13.00	-	3.307	84	5.93	150.5	45	14	360M13000A21M
33/64	0.5156	13.10	9/16-18	3.307	84	5.93	150.5	45	14	360E05156A21M
-	0.5197	13.20	-	3.307	84	5.93	150.5	45	14	360M13200A21M
17/32	0.5312	13.49	5/8-11	3.307	84	5.93	150.5	45	14	360E05312A21M
-	0.5315	13.50	-	3.307	84	5.93	150.5	45	14	360M13500A21M
-	0.5433	13.80	-	3.307	84	5.93	150.5	45	14	360M13800A21M
35/64	0.5469	13.89	5/8-12	3.307	84	5.93	150.5	45	14	360E05469A21M
-	0.5512	14.00	M16x2	3.307	84	5.93	150.5	45	14	360M14000A21M
9/16	0.5625	14.29	-	3.780	96	6.65	168.9	48	16	360E05625A21M
-	0.5709	14.50	M16x1.5	3.780	96	6.65	168.9	48	16	360M14500A21M
37/64	0.5781	14.68	5/8-18	3.780	96	6.65	168.9	48	16	360E05781A21M
-	0.5906	15.00	-	3.780	96	6.65	168.9	48	16	360M15000A21M
19/32	0.5938	15.08	-	3.780	96	6.65	168.9	48	16	360E05938A21M
39/64	0.6094	15.48	11/16-12	3.780	96	6.65	168.9	48	16	360E06094A21M
-	0.6102	15.50	M18x2.5	3.780	96	6.65	168.9	48	16	360M15500A21M
5/8	0.6250	15.88	-	3.780	96	6.65	168.9	48	16	360E06250A21M
-	0.6299	16.00	-	3.780	96	6.65	168.9	48	16	360M16000A21M

\*Tap drill diameters allow approximately 75% of full thread to be produced

A10: 12 - 14

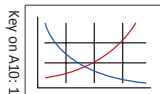

A10: 2



Sizes not shown are available as non-stocked standards.

When ordering, please follow the examples shown below:

<b>Inch</b>	Diameter needed = 0.3450"	Part No. = 335E03450A21M
<b>Metric</b>	Diameter needed = 7.250mm	Part No. = 335M07250A21M



Solid Carbide Drills

6xD | Diameter Range: 0.1181" - 0.7874" (3.00mm - 20.00mm)

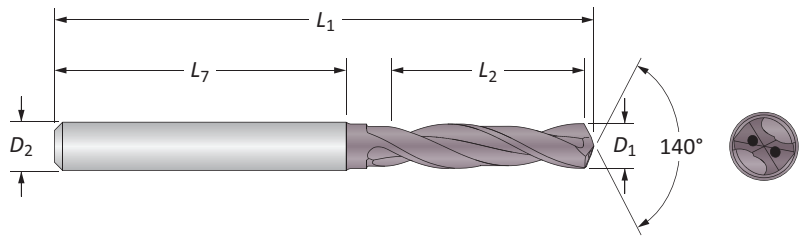

Fractional Equivalent	D <sub>1</sub>		Tap Size*	Body				Shank		Part No.
	inch	mm		L <sub>2</sub> inch	L <sub>2</sub> mm	L <sub>1</sub> inch	L <sub>1</sub> mm	L <sub>7</sub> mm	D <sub>2</sub> mm	
-	0.6307	16.02	-	4.252	108	7.22	183.3	48	18	360M16020A21M
-	0.6331	16.08	-	4.252	108	7.22	183.3	48	18	360M16080A21M
-	0.6378	16.20	-	4.252	108	7.22	183.3	48	18	360M16200A21M
41/64	0.6406	16.27	-	4.252	108	7.22	183.3	48	18	360E06406A21M
-	0.6496	16.50	M18x1.5	4.252	108	7.22	183.3	48	18	360M16500A21M
21/32	0.6563	16.67	3/4-10	4.252	108	7.22	183.3	48	18	360E06563A21M
-	0.6693	17.00	-	4.252	108	7.22	183.3	48	18	360M17000A21M
43/64	0.6719	17.07	3/4-12	4.252	108	7.22	183.3	48	18	360E06719A21M
11/16	0.6875	17.46	3/4-16	4.252	108	7.22	183.3	48	18	360E06875A21M
-	0.6890	17.50	M20x2.5	4.252	108	7.22	183.3	48	18	360M17500A21M
45/64	0.7031	17.86	-	4.252	108	7.22	183.3	48	18	360E07031A21M
-	0.7087	18.00	-	4.252	108	7.22	183.3	48	18	360M18000A21M
-	0.7098	18.03	-	4.724	120	7.86	199.6	50	20	360M18030A21M
23/32	0.7188	18.26	-	4.724	120	7.86	199.6	50	20	360E07188A21M
-	0.7283	18.50	M20x1.5	4.724	120	7.86	199.6	50	20	360M18500A21M
47/64	0.7344	18.65	-	4.724	120	7.86	199.6	50	20	360E07344A21M
-	0.7480	19.00	-	4.724	120	7.86	199.6	50	20	360M19000A21M
3/4	0.7500	19.05	-	4.724	120	7.86	199.6	50	20	360E07500A21M
-	0.7520	19.10	-	4.724	120	7.86	199.6	50	20	360M19100A21M
-	0.7535	19.14	-	4.724	120	7.86	199.6	50	20	360M19140A21M
-	0.7543	19.16	-	4.724	120	7.86	199.6	50	20	360M19160A21M
-	0.7559	19.20	-	4.724	120	7.86	199.6	50	20	360M19200A21M
-	0.7580	19.25	-	4.724	120	7.86	199.6	50	20	360E07580A21M
-	0.7598	19.30	-	4.724	120	7.86	199.6	50	20	360M19300A21M
49/64	0.7656	19.45	7/8-9	4.724	120	7.86	199.6	50	20	360E07656A21M
-	0.7677	19.50	M22x2.5	4.724	120	7.86	199.6	50	20	360M19500A21M
25/32	0.7813	19.84	-	4.724	120	7.86	199.6	50	20	360E07813A21M
-	0.7874	20.00	-	4.724	120	7.86	199.6	50	20	360M20000A21M

\*Tap drill diameters allow approximately 75% of full thread to be produced

A10: 12 - 14 A10: 2

Sizes not shown are available as non-stocked standards. When ordering, please follow the examples shown below:

Inch	Diameter needed = 0.3450"	Part No. = 335E03450A21M
Metric	Diameter needed = 7.250mm	Part No. = 335M07250A21M

A DRILLING  
B BORING  
C REAMING  
D BURNISHING  
E THREADING  
X SPECIALS

## Solid Carbide Drills

9xD | Diameter Range: 0.1181" - 0.7874" (3.00mm - 20.00mm)

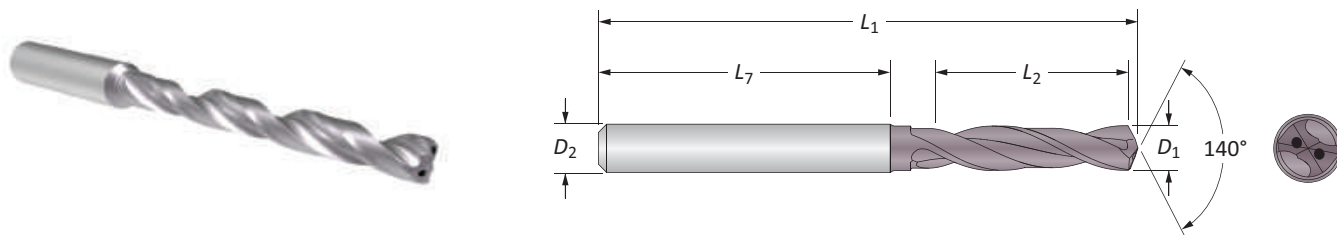

Fractional Equivalent	D <sub>1</sub>		Tap Size*	Body				Shank		Part No.
	inch	mm		L <sub>2</sub> inch	L <sub>2</sub> mm	L <sub>1</sub> inch	L <sub>1</sub> mm	L <sub>7</sub> mm	D <sub>2</sub> mm	
-	0.1969	5.00	M6x1	2.126	54	3.98	101.1	36	6	390M05000A21M
-	0.2362	6.00	M7x1	2.126	54	3.98	101.1	36	6	390M06000A21M
D	0.2461	6.25	-	2.835	72	4.86	123.4	36	8	390E02461A21M
1/4	0.2500	6.35	-	2.835	72	4.86	123.4	36	8	390E02500A21M
-	0.2559	6.50	-	2.835	72	4.86	123.4	36	8	390M06500A21M
17/64	0.2656	6.75	M8x1.25	2.835	72	4.86	123.4	36	8	390E02656A21M
I	0.2720	6.91	5/16-24	2.835	72	4.86	123.4	36	8	390E02720A21M
-	0.2756	7.00	M8x1	2.835	72	4.86	123.4	36	8	390M07000A21M
-	0.2953	7.50	-	2.835	72	4.86	123.4	36	8	390M07500A21M
19/64	0.2969	7.54	-	2.835	72	4.86	123.4	36	8	390E02969A21M
5/16	0.3125	7.94	3/8-16	2.835	72	4.86	123.4	36	8	390E03125A21M
-	0.3150	8.00	-	2.835	72	4.86	123.4	36	8	390M08000A21M
21/64	0.3281	8.33	-	3.543	90	5.74	145.8	40	10	390E03281A21M
Q	0.3319	8.43	3/8-24	3.543	90	5.74	145.8	40	10	390M08430A21M
-	0.3346	8.50	M10x1.5	3.543	90	5.74	145.8	40	10	390M08500A21M
-	0.3386	8.60	-	3.543	90	5.74	145.8	40	10	390M08600A21M
11/32	0.3438	8.73	-	3.543	90	5.74	145.8	40	10	390E03438A21M
-	0.3465	8.80	-	3.543	90	5.74	145.8	40	10	390M08800A21M
-	0.3543	9.00	-	3.543	90	5.74	145.8	40	10	390M09000A21M
23/64	0.3594	9.13	-	3.543	90	5.74	145.8	40	10	390E03594A21M
U	0.3680	9.35	7/16-14	3.543	90	5.74	145.8	40	10	390E03680A21M
-	0.3740	9.50	-	3.543	90	5.74	145.8	40	10	390M09500A21M
3/8	0.3750	9.53	-	3.543	90	5.74	145.8	40	10	390E03750A21M
-	0.3780	9.60	-	3.543	90	5.74	145.8	40	10	390M09600A21M
25/64	0.3906	9.92	7/16-20	3.543	90	5.74	145.8	40	10	390E03906A21M
-	0.3937	10.00	-	3.543	90	5.74	145.8	40	10	390M10000A21M
-	0.4016	10.20	M12x1.75	4.252	108	6.78	172.2	45	12	390M10200A21M
-	0.4040	10.26	-	4.252	108	6.78	172.2	45	12	390E04040A21M
13/32	0.4062	10.32	-	4.252	108	6.78	172.2	45	12	390E04062A21M
-	0.4134	10.50	-	4.252	108	6.78	172.2	45	12	390M10500A21M
27/64	0.4219	10.72	1/2-13	4.252	108	6.78	172.2	45	12	390E04219A21M
-	0.4331	11.00	-	4.252	108	6.78	172.2	45	12	390M11000A21M
7/16	0.4375	11.11	-	4.252	108	6.78	172.2	45	12	390E04375A21M
-	0.4528	11.50	-	4.252	108	6.78	172.2	45	12	390M11500A21M
29/64	0.4531	11.51	1/2-20	4.252	108	6.78	172.2	45	12	390E04531A21M
15/32	0.4688	11.91	-	4.252	108	6.78	172.2	45	12	390E04688A21M
-	0.4724	12.00	M14x2	4.252	108	6.78	172.2	45	12	390M12000A21M

\*Tap drill diameters allow approximately 75% of full thread to be produced

A10: 12 - 14

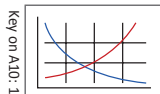

A10: 2



Sizes not shown are available as non-stocked standards.

When ordering, please follow the examples shown below:

<b>Inch</b>	Diameter needed = 0.3450"	Part No. = 335E03450A21M
<b>Metric</b>	Diameter needed = 7.250mm	Part No. = 335M07250A21M

**Solid Carbide Drills**

9xD | Diameter Range: 0.1181" - 0.7874" (3.00mm - 20.00mm)

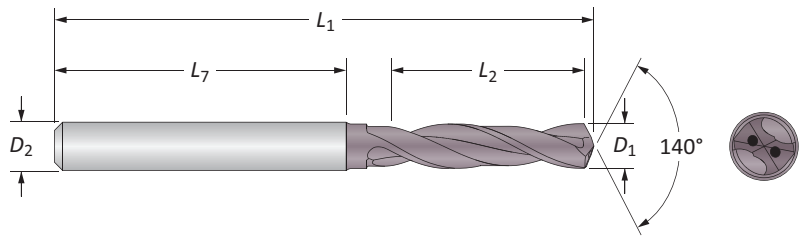

Fractional Equivalent	D <sub>1</sub>		Tap Size*	Body				Shank		Part No.
	inch	mm		L <sub>2</sub> inch	L <sub>2</sub> mm	L <sub>1</sub> inch	L <sub>1</sub> mm	L <sub>7</sub> mm	D <sub>2</sub> mm	
31/64	0.4844	12.30	9/16-12	4.961	126	7.58	192.5	45	14	390E04844A21M
-	0.4921	12.50	M14x1.5	4.961	126	7.58	192.5	45	14	390M12500A21M
1/2	0.5000	12.70	-	4.961	126	7.58	192.5	45	14	390E05000A21M
-	0.5118	13.00	-	4.961	126	7.58	192.5	45	14	390M13000A21M
33/64	0.5156	13.10	9/16-18	4.961	126	7.58	192.5	45	14	390E05156A21M
17/32	0.5312	13.49	5/8-11	4.961	126	7.58	192.5	45	14	390E05312A21M
-	0.5315	13.50	-	4.961	126	7.58	192.5	45	14	390M13500A21M
35/64	0.5469	13.89	5/8-12	4.961	126	7.58	192.5	45	14	390E05469A21M
-	0.5512	14.00	M16x2	4.961	126	7.58	192.5	45	14	390M14000A21M
9/16	0.5625	14.29	-	5.669	144	8.54	216.9	48	16	390E05625A21M
-	0.5709	14.50	M16x1.5	5.669	144	8.54	216.9	48	16	390M14500A21M
37/64	0.5781	14.68	5/8-18	5.669	144	8.54	216.9	48	16	390E05781A21M
-	0.5906	15.00	-	5.669	144	8.54	216.9	48	16	390M15000A21M
19/32	0.5938	15.08	-	5.669	144	8.54	216.9	48	16	390E05938A21M
39/64	0.6094	15.48	11/16-12	5.669	144	8.54	216.9	48	16	390E06094A21M
-	0.6102	15.50	M18x2.5	5.669	144	8.54	216.9	48	16	390M15500A21M
5/8	0.6250	15.88	-	5.669	144	8.54	216.9	48	16	390E06250A21M
-	0.6299	16.00	-	5.669	144	8.54	216.9	48	16	390M16000A21M
41/64	0.6406	16.27	-	6.378	162	9.34	237.3	48	18	390E06406A21M
-	0.6496	16.50	M18x1.5	6.378	162	9.34	237.3	48	18	390M16500A21M
21/32	0.6563	16.67	3/4-10	6.378	162	9.34	237.3	48	18	390E06563A21M
-	0.6693	17.00	-	6.378	162	9.34	237.3	48	18	390M17000A21M
43/64	0.6719	17.07	3/4-12	6.378	162	9.34	237.3	48	18	390E06719A21M
11/16	0.6875	17.46	3/4-16	6.378	162	9.34	237.3	48	18	390E06875A21M
-	0.6890	17.50	M20x2.5	6.378	162	9.34	237.3	48	18	390M17500A21M
45/64	0.7031	17.86	-	6.378	162	9.34	237.3	48	18	390E07031A21M
-	0.7087	18.00	-	6.378	162	9.34	237.3	48	18	390M18000A21M
23/32	0.7188	18.26	-	7.087	180	10.22	259.6	50	20	390E07188A21M
-	0.7283	18.50	M20x1.5	7.087	180	10.22	259.6	50	20	390M18500A21M
47/64	0.7344	18.65	-	7.087	180	10.22	259.6	50	20	390E07344A21M
-	0.7480	19.00	-	7.087	180	10.22	259.6	50	20	390M19000A21M
3/4	0.7500	19.05	-	7.087	180	10.22	259.6	50	20	390E07500A21M
49/64	0.7656	19.45	7/8-09	7.087	180	10.22	259.6	50	20	390E07656A21M
-	0.7677	19.50	M22x2.5	7.087	180	10.22	259.6	50	20	390M19500A21M
25/32	0.7813	19.84	-	7.087	180	10.22	259.6	50	20	390E07813A21M
-	0.7874	20.00	-	7.087	180	10.22	259.6	50	20	390M20000A21M

\*Tap drill diameters allow approximately 75% of full thread to be produced

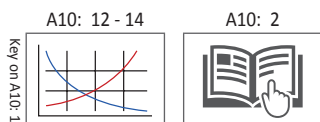

Sizes not shown are available as non-stocked standards. When ordering, please follow the examples shown below:

<b>Inch</b>	Diameter needed = 0.3450"	Part No. = 335E03450A21M
<b>Metric</b>	Diameter needed = 7.250mm	Part No. = 335M07250A21M

A  
DRILLING  
B  
BORING  
C  
REAMING  
D  
BURNISHING  
E  
THREADING  
X  
SPECIALS

## Recommended Drilling Data | Imperial (inch)

ISO	Material	Hardness (BHN)	Speed (SFM)	Feed Rate (IPR) by Diameter								
				0.118 - 0.157	0.161 - 0.236	0.240 - 0.315	0.319 - 0.394	0.398 - 0.472	0.476 - 0.551	0.555 - 0.630	0.634 - 0.709	0.713 - 0.787
P	Free Machining Steel 1118, 1215, 12L14, etc.	100 - 150	450	0.007	0.009	0.011	0.013	0.014	0.016	0.018	0.020	0.022
		150 - 200	400	0.005	0.008	0.009	0.011	0.012	0.014	0.016	0.018	0.020
		200 - 250	375	0.004	0.006	0.007	0.009	0.010	0.012	0.014	0.016	0.018
	Low Carbon Steel 1010, 1020, 1025, 1522, 1144, etc.	85 - 125	425	0.007	0.009	0.011	0.013	0.015	0.017	0.019	0.019	0.021
		125 - 175	390	0.006	0.008	0.010	0.012	0.014	0.016	0.018	0.018	0.020
		175 - 225	360	0.005	0.008	0.010	0.011	0.013	0.015	0.017	0.017	0.019
	Medium Carbon Steel 1030, 1040, 1050, 1527, 1140, 1151, etc.	225 - 275	330	0.004	0.007	0.009	0.010	0.012	0.014	0.016	0.016	0.018
		125 - 175	390	0.006	0.008	0.010	0.012	0.013	0.014	0.016	0.018	0.020
		175 - 225	360	0.005	0.007	0.010	0.012	0.012	0.013	0.015	0.017	0.019
	Alloy Steel 4140, 5140, 8640, etc.	225 - 275	320	0.004	0.006	0.009	0.011	0.011	0.012	0.014	0.016	0.018
		275 - 325	285	0.003	0.006	0.008	0.010	0.010	0.011	0.013	0.015	0.017
		175 - 225	375	0.006	0.008	0.010	0.012	0.013	0.014	0.016	0.018	0.020
High Strength Alloy 4340, 4330V, 300M, etc.	225 - 275	340	0.005	0.007	0.009	0.011	0.012	0.013	0.015	0.017	0.019	
	275 - 325	300	0.004	0.006	0.008	0.010	0.011	0.012	0.013	0.016	0.018	
	325 - 375	275	0.003	0.005	0.007	0.009	0.010	0.010	0.012	0.014	0.016	
Structural Steel A36, A285, A516, etc.	225 - 300	260	0.005	0.007	0.008	0.011	0.011	0.012	0.013	0.014	0.016	
	300 - 350	210	0.004	0.006	0.007	0.009	0.010	0.011	0.012	0.013	0.015	
	350 - 400	160	0.003	0.005	0.006	0.008	0.009	0.010	0.011	0.012	0.013	
Tool Steel H-13, H-21, A-4, O-2, S-3, etc.	100 - 150	360	0.005	0.008	0.009	0.011	0.012	0.013	0.014	0.016	0.018	
	150 - 250	320	0.004	0.007	0.008	0.010	0.011	0.012	0.013	0.015	0.017	
	250 - 350	270	0.003	0.005	0.007	0.008	0.009	0.010	0.011	0.013	0.015	
S	High Temp Alloy Hastelloy B, Inconel 600, etc.	150 - 200	260	0.003	0.004	0.005	0.006	0.007	0.008	0.009	0.010	0.011
		200 - 250	220	0.002	0.003	0.004	0.005	0.006	0.007	0.008	0.009	0.010
M	Stainless Steel 300 Series 304, 316, 17-4PH, etc.	140 - 220	120	0.003	0.004	0.005	0.006	0.007	0.008	0.009	0.010	0.011
		220 - 310	90	0.002	0.003	0.003	0.004	0.005	0.006	0.007	0.008	0.009
K	Nodular, Grey, Ductile Cast Iron	135 - 185	200	0.004	0.005	0.006	0.007	0.008	0.009	0.011	0.012	0.013
		185 - 275	140	0.003	0.004	0.004	0.005	0.006	0.007	0.009	0.010	0.011
		120 - 150	550	0.008	0.010	0.012	0.014	0.016	0.018	0.020	0.022	0.024
		150 - 200	500	0.008	0.010	0.012	0.014	0.016	0.018	0.020	0.022	0.024
		200 - 220	475	0.007	0.009	0.011	0.013	0.015	0.017	0.019	0.021	0.023
N	Cast Aluminum	220 - 260	430	0.007	0.009	0.011	0.013	0.015	0.017	0.019	0.021	0.023
		260 - 320	400	0.006	0.008	0.010	0.012	0.014	0.016	0.018	0.020	0.022
		30	1500	0.008	0.010	0.013	0.015	0.017	0.020	0.022	0.024	0.026
Wrought Aluminum	180	1000	0.006	0.008	0.011	0.013	0.015	0.018	0.020	0.022	0.024	
	30	1500	0.008	0.010	0.013	0.015	0.017	0.020	0.022	0.024	0.026	
		180	1000	0.006	0.008	0.011	0.013	0.015	0.018	0.020	0.022	0.024

### Speed and Feed Adjustment

3.5xD	6xD	9xD
See above chart	0.90	0.75

### Recommended Speed and Feed Example

If the recommended speed and feed is 300 SFM and 0.010 IPR, then reduce to 225 SFM and 0.0075 IPR when using a 9xD tool	
$300 \cdot 0.75 = 225 \text{ SFM}$	$0.010 \cdot 0.75 = 0.0075 \text{ IPR}$

### Calculations

Value	Formula
IPM	$\text{RPM} \cdot \text{IPR}$
SFM	$\text{RPM} \cdot 0.262 \cdot \text{DIA}$
RPM	$(\text{SFM} \cdot 3.82) / \text{DIA}$

**IMPORTANT:** The speeds and feeds listed above are a general starting point for all applications. Refer to the Coolant Recommendation charts for coolant requirements to run at the recommended speeds and feeds. Factory technical assistance is available through our Application Engineering department.

**Recommended Drilling Data | Metric (mm)**

ISO	Material	Hardness (BHN)	Speed (M/min)	Feed Rate (mm/rev) by Diameter								
				3.00 - 4.00	4.01 - 6.00	6.01 - 8.00	8.01 - 10.00	10.01 - 12.00	12.01 - 14.00	14.01 - 16.00	16.01 - 18.00	18.01 - 20.00
P	Free Machining Steel 1118, 1215, 12L14, etc.	100 - 150	137	0.18	0.23	0.28	0.33	0.36	0.41	0.46	0.51	0.56
		150 - 200	122	0.13	0.20	0.23	0.28	0.30	0.36	0.41	0.46	0.51
		200 - 250	114	0.10	0.15	0.18	0.23	0.25	0.30	0.36	0.41	0.46
	Low Carbon Steel 1010, 1020, 1025, 1522, 1144, etc.	85 - 125	130	0.18	0.23	0.28	0.33	0.38	0.43	0.48	0.48	0.53
		125 - 175	119	0.15	0.20	0.25	0.30	0.36	0.41	0.46	0.46	0.51
		175 - 225	110	0.13	0.20	0.25	0.28	0.33	0.38	0.43	0.43	0.48
	Medium Carbon Steel 1030, 1040, 1050, 1527, 1140, 1151, etc.	225 - 275	101	0.10	0.18	0.23	0.25	0.30	0.36	0.41	0.41	0.46
		125 - 175	119	0.15	0.20	0.25	0.30	0.33	0.36	0.41	0.46	0.51
		175 - 225	110	0.13	0.18	0.25	0.30	0.30	0.33	0.38	0.43	0.48
	Alloy Steel 4140, 5140, 8640, etc.	225 - 275	98	0.10	0.15	0.23	0.28	0.28	0.30	0.36	0.41	0.48
		275 - 325	87	0.08	0.15	0.20	0.25	0.25	0.28	0.33	0.38	0.43
		275 - 325	91	0.10	0.15	0.20	0.25	0.28	0.30	0.33	0.41	0.46
	High Strength Alloy 4340, 4330V, 300M, etc.	325 - 375	84	0.08	0.13	0.18	0.23	0.25	0.25	0.30	0.36	0.41
		225 - 300	79	0.13	0.18	0.20	0.28	0.28	0.30	0.33	0.36	0.41
		300 - 350	64	0.10	0.15	0.18	0.23	0.25	0.28	0.30	0.33	0.38
	Structural Steel A36, A285, A516, etc.	350 - 400	49	0.08	0.13	0.15	0.20	0.23	0.25	0.28	0.30	0.33
		100 - 150	110	0.13	0.20	0.23	0.28	0.30	0.33	0.36	0.41	0.46
		150 - 250	98	0.10	0.18	0.20	0.25	0.28	0.30	0.33	0.38	0.43
Tool Steel H-13, H-21, A-4, O-2, S-3, etc.	250 - 350	82	0.08	0.13	0.18	0.20	0.23	0.25	0.28	0.33	0.38	
	150 - 200	79	0.08	0.10	0.13	0.15	0.18	0.20	0.23	0.25	0.28	
S	High Temp Alloy Hastelloy B, Inconel 600, etc.	200 - 250	67	0.05	0.08	0.10	0.13	0.15	0.18	0.20	0.23	0.25
		140 - 220	37	0.08	0.10	0.13	0.15	0.18	0.20	0.23	0.25	0.28
M	Stainless Steel 300 Series 304, 316, 17-4PH, etc.	220 - 310	27	0.05	0.08	0.08	0.10	0.13	0.15	0.18	0.20	0.23
		135 - 185	61	0.10	0.13	0.15	0.18	0.20	0.23	0.28	0.30	0.33
K	Nodular, Grey, Ductile Cast Iron	185 - 275	43	0.08	0.10	0.10	0.13	0.15	0.18	0.23	0.25	0.28
		120 - 150	168	0.20	0.25	0.30	0.36	0.41	0.46	0.51	0.56	0.61
		150 - 200	152	0.20	0.25	0.30	0.36	0.41	0.46	0.51	0.56	0.61
		200 - 220	145	0.18	0.23	0.28	0.33	0.38	0.43	0.48	0.53	0.58
		220 - 260	131	0.18	0.23	0.28	0.33	0.38	0.43	0.48	0.53	0.58
N	Cast Aluminum	260 - 320	122	0.15	0.20	0.25	0.30	0.36	0.41	0.46	0.51	0.56
		30	457	0.20	0.25	0.33	0.38	0.43	0.51	0.56	0.61	0.66
	Wrought Aluminum	180	305	0.15	0.20	0.28	0.33	0.38	0.46	0.51	0.56	0.61
		30	457	0.20	0.25	0.33	0.38	0.43	0.51	0.56	0.61	0.66
		180	305	0.15	0.20	0.28	0.33	0.38	0.46	0.51	0.56	0.61

**Speed and Feed Adjustment**

3.5xD	6xD	9xD
See above chart	0.90	0.75

**Recommended Speed and Feed Example**

If the recommended speed and feed is 91 M/min and 0.25 mm/rev, then reduce to 68 M/min and 0.19 mm/rev when using a 9xD tool	
$91 \cdot 0.75 = 68 \text{ M/min}$	$0.25 \cdot 0.75 = 0.19 \text{ mm/rev}$

**Calculations**

Value	Formula
mm/min	$\text{RPM} \cdot \text{mm/rev}$
M/min	$\text{RPM} \cdot 0.003 \cdot \text{DIA}$
RPM	$(\text{M/min} \cdot 318.47) / \text{DIA}$

**IMPORTANT:** The speeds and feeds listed above are a general starting point for all applications. Refer to the Coolant Recommendation charts for coolant requirements to run at the recommended speeds and feeds. Factory technical assistance is available through our Application Engineering department.

A  
DRILLING  
B  
BORING  
C  
REAMING  
D  
BURNISHING  
E  
THREADING  
X  
SPECIALS

## Coolant Recommendations

### Imperial (PSI)

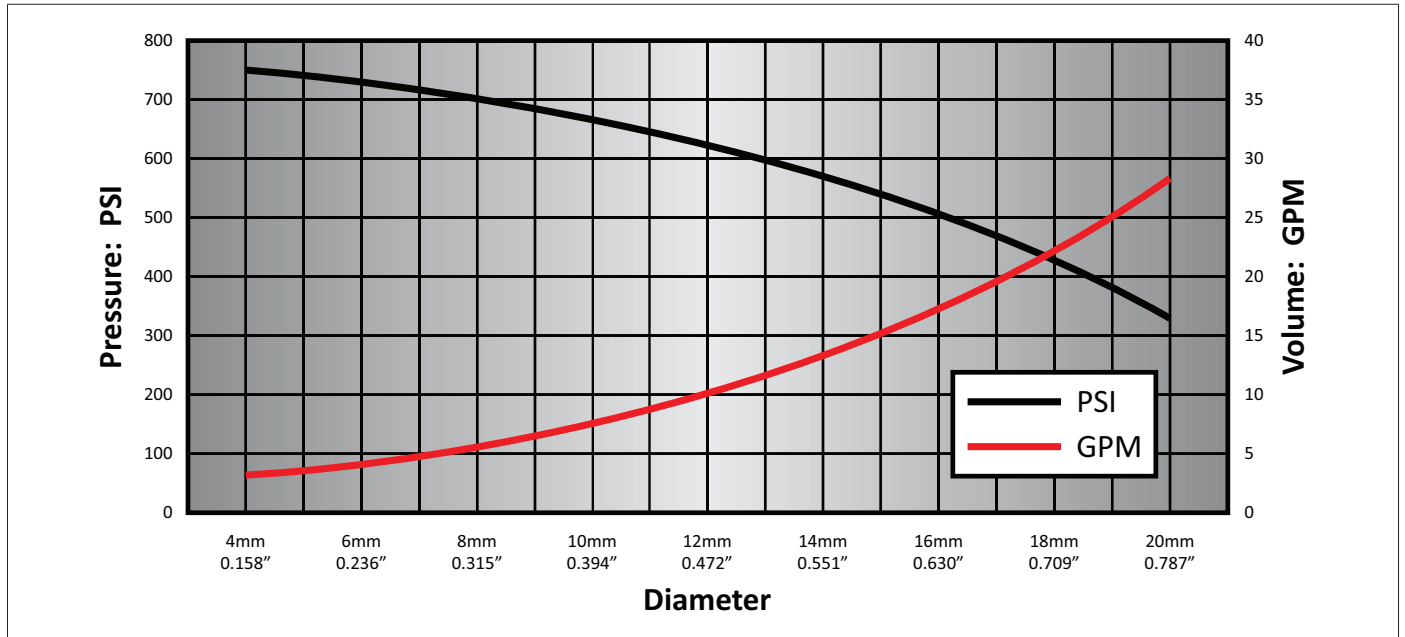

### Metric (bar)

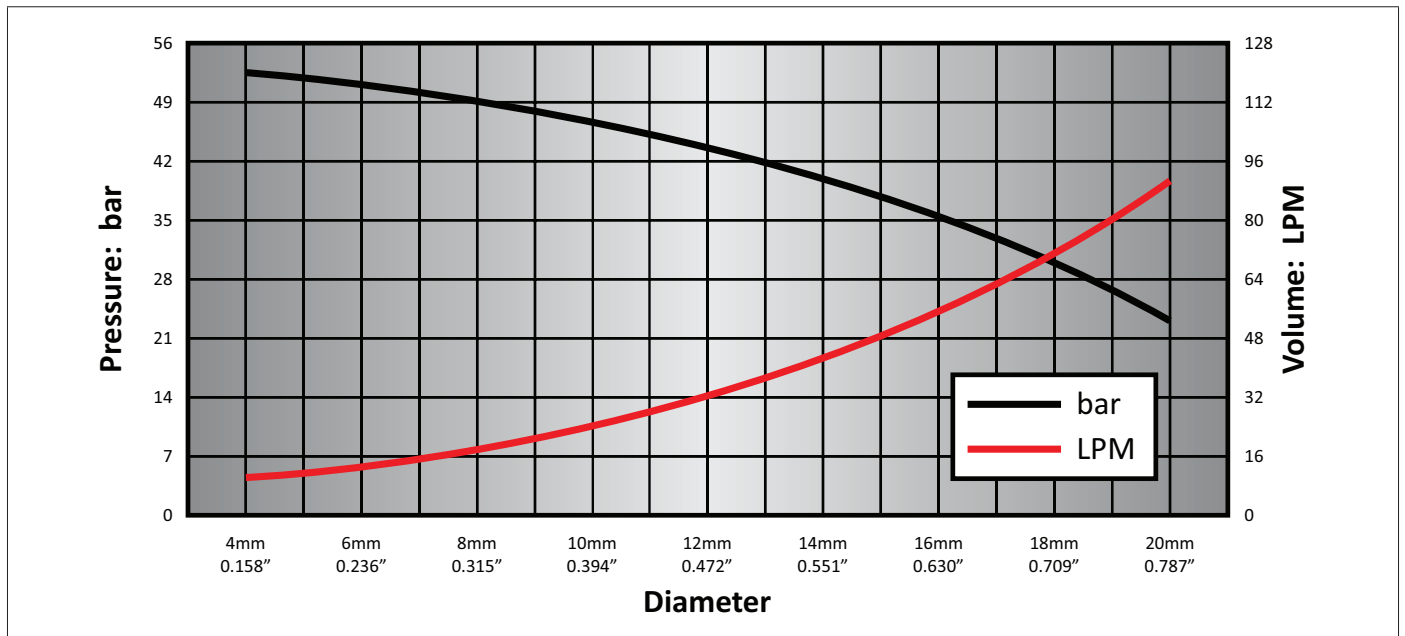

### Coolant Adjustment

Drill Length	Pressure and Flow
3.5xD	See above chart
6xD	1.5
9xD	2.0

### Coolant Recommendation Example

If the recommended coolant pressure and flow is 600 PSI and 12 GPM for a 3xD tool, the adjusted pressure and flow for a 9xD tool would be:

$600 \cdot 2 = 1200 \text{ PSI}$	$12 \cdot 2 = 24 \text{ GPM}$
----------------------------------	-------------------------------

**IMPORTANT:** The coolant pressure and flow rate recommendations above represent a good approximation to obtain optimum tool life and chip evacuation at Allied recommended speeds and feeds. If lower coolant capabilities exist in a drilling application, the ASC 320 drilling system will still function at reduced penetration rates. Contact our Application Engineering Department for a more specific recommendation of coolant requirements and/or speeds and feeds.







SECTION

---

# A20

---

GEN3SYS® XT & XT Pro

# GEN3SYS® XT and XT Pro

High Penetration Replaceable Insert Drilling System | GEN3SYS XT | GEN3SYS XT Pro

► Diameter Range: 0.4331" - 1.3780" (11.00mm - 35.00mm)



## The Next Generation of Drilling

The GEN3SYS XT and XT Pro replaceable insert high penetration drilling system has been designed to provide high speed production machining beyond the capabilities of the T-A® drilling system. The product offering consists of various grades, geometries, and coatings available to suit the most demanding applications.

Conceived from the outset as the ultimate high performance drilling solution, the GEN3SYS XT drill range is incredibly versatile. Incorporating both straight and helical fluted tool holder options across the range, as well as through coolant for maximum material removal, GEN3SYS XT not only gives outstanding performance from day one, but it can also be reground for extended life and economy.

Excellent chip control	Improves hole quality and surface finish	Provides maximum durability and stability
------------------------	--	---

## Applicable Industries



Aerospace



Agriculture



Automotive



Firearms



General Machining



Oil & Gas



Renewable Energy

Your safety and the safety of others is very important. This catalog contains important safety messages. Always read and follow all safety precautions.



This triangle is a safety hazard symbol. It alerts you to potential safety hazards that can cause tool failure and serious injury.

When you see this symbol in the catalog, look for a related safety message that may be near this triangle or referred to in the nearby text.

There are safety signal words also used in the catalog. Safety messages follow these words.

### **WARNING**

**WARNING** (shown above) means that failure to follow the precautions in this message could result in tool failure and serious injury.

**NOTICE** means that failure to follow the precautions in this message could result in damage to the tool or machine but not result in personal injury.

**NOTE** and **IMPORTANT** are also used. These are important that you read and follow but are not safety-related.

Visit [www.alliedmachine.com](http://www.alliedmachine.com) for the most up-to-date information and procedures.

# GEN3SYS® XT and XT Pro Drilling System Contents

## Reference Icons

The following icons will appear throughout the catalog to help you navigate between products.



### Setup / Assembly Information

Detailed instructions and information regarding the corresponding part(s)

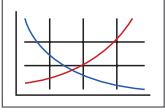

### Recommended Cutting Data

Speed and feed recommendations for optimum and safe boring

Series	Diameter Range	
	Imperial (inch)	Metric (mm)
11	0.4331 - 0.4723	11.00 - 11.99
12	0.4724 - 0.5117	12.00 - 12.99
13	0.5118 - 0.5511	13.00 - 13.99
14	0.5512 - 0.5905	14.00 - 14.99
15	0.5906 - 0.6298	15.00 - 15.99
16	0.6299 - 0.6692	16.00 - 16.99
17	0.6693 - 0.7086	17.00 - 17.99
18	0.7087 - 0.7873	18.00 - 19.99
20	0.7874 - 0.8660	20.00 - 21.99
22	0.8661 - 0.9448	22.00 - 23.99
24	0.9449 - 1.0235	24.00 - 25.99
26	1.0236 - 1.1416	26.00 - 28.99
29	1.1417 - 1.2597	29.00 - 31.99
32	1.2598 - 1.3780	32.00 - 35.00

## Introduction Information

Why You Should Use the Pro . . . . .	2 - 3
Test Results and Case Study . . . . .	4 - 5
GEN3SYS XT Pro Inserts . . . . .	6
GEN3SYS XT Inserts . . . . .	7
Insert Comparison and Assembly Details . . . . .	8
Holder Comparison and Overview . . . . .	9
Product Nomenclature . . . . .	10 - 11

## Drill Series

11 Series . . . . .	12 - 15
12 Series . . . . .	16 - 19
13 Series . . . . .	20 - 23
14 Series . . . . .	24 - 27
15 Series . . . . .	28 - 31
16 Series . . . . .	32 - 35
17 Series . . . . .	36 - 39
18 Series . . . . .	40 - 43
20 Series . . . . .	44 - 47
22 Series . . . . .	48 - 51
24 Series . . . . .	52 - 55
26 Series . . . . .	56 - 59
29 Series . . . . .	60 - 63
32 Series . . . . .	64 - 67

## Recommended Cutting Data

Imperial (inch)	[	GEN3SYS XT Pro . . . . .	68 - 71
		GEN3SYS XT . . . . .	72 - 75
Metric (mm)	[	GEN3SYS XT Pro . . . . .	76 - 79
		GEN3SYS XT . . . . .	80 - 83
Tap Drill Conversions . . . . .			84 - 85
Deep Hole Drilling Guidelines . . . . .			86
Troubleshooting Guide . . . . .			87

A DRILLING  
B BORING  
C REAMING  
D BURNISHING  
E THREADING  
X SPECIALS

# Why should you GO WITH THE PRO?

## GEN3SYS® XT Pro

- ✓ **Up to 40% more tool life**  
with the new design for steel applications
- ✓ **Increase your penetration rates**  
with the new insert technology
- ✓ **Simplify your tooling selection**  
with new specific geometry and coating combinations
- ✓ **Increased heat resistance**  
with new AM420 coating on steel inserts
- ✓ **Increased abrasion resistance**  
with new AM440 coating on cast iron inserts
- ✓ **Improved chip evacuation**  
with enhanced flute design on new XT Pro holders
- ✓ **Increased coolant flow to the cutting zone**  
with new coolant configuration on XT Pro holders



**INCREASED**  
penetration rate by  
**67%**

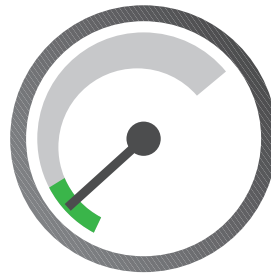

Competitor Insert Penetration Rate



XT Pro Insert Penetration Rate

**Project Profile:** 7075 Aluminum

**Tooling Solution:** GEN3SYS XT Pro: N (Non-Ferrous) Geometry

**The Problem:**  
Previously, the customer was using a competitor drill running at the following parameters:

- 30 IPM (762 mm/min)
- Tool life = 15,000" (381 m)

**The Solution:**  
Allied Machine recommended the GEN3SYS XT Pro with N (Non-Ferrous) geometry.

- **Insert** = XTN24-25.00

The tool ran at the following parameters:

- 50 IPM (1270 mm/min)
- Tool life = 26,000" (660.4 m)

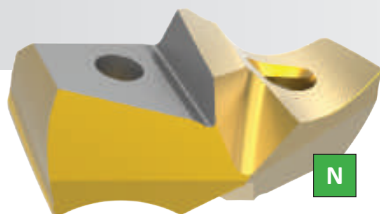

**The Advantage:**  
The GEN3SYS XT Pro increased the penetration rate from 30 IPM to 50 IPM, while *drastically increasing the tool life*.

**Bottom Line:** **67% increase in penetration rate** | **73% increase in tool life**

**Project Profile:** Forged 8640  
**Tooling Solution:** GEN3SYS XT Pro: P (Steel) Geometry

**The Problem:**  
Previously, the customer was using a competitor drill running at the following parameters:

- 415 SFM (127 M/min)
- 0.009 IPR (0.23 mm/rev)
- The tool drilled a 17.25mm diameter hole to a 20mm depth
- Tool life = **1,000 holes**

**The Solution:**  
Allied Machine recommended the GEN3SYS XT Pro with P (Steel) geometry.

- **Insert** = XTP17-17.25

The tool ran at the following parameters:

- 415 SFM (127 M/min)
- 0.009 IPR (0.23 mm/rev)
- The tool drilled a 17.25mm diameter hole to a 20mm depth
- Tool life = **2,100 holes**

**The Advantage:**  
The GEN3SYS XT Pro increased the tool life from 1,000 holes to 2,100 holes.  
**Bottom Line:** *Doubled the tool life*

# The PROOF is in the NUMBERS

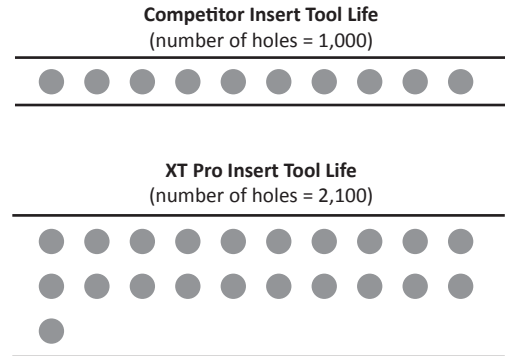

**INCREASE** in  
**2x** tool life

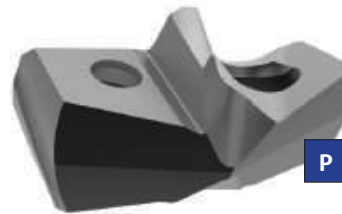

## NEW HOLDER DESIGN

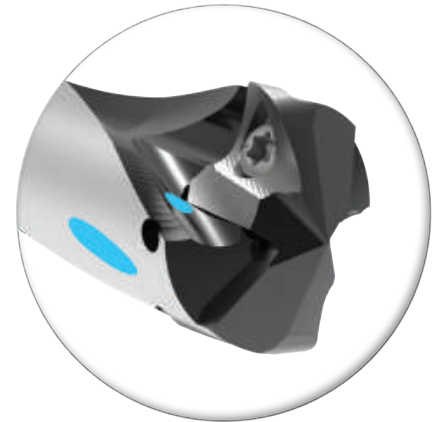

### Drill deeper holes

The new XT Pro holders are now available in 10xD.  
▶ **This lets you take advantage of the XT Pro insert benefits in deep hole applications.**

### Increase your tool life

The new coolant configuration increases coolant flow and directs additional coolant to the cutting zone.  
▶ **This increases tool life with all XT Pro inserts.**

That's why you should  
**GO WITH THE PRO**

Competitive Test Results

A  
DRILLING  
B  
BORING  
C  
REAMING  
D  
BURNISHING  
E  
THREADING  
X  
SPECIALS

# TEST RESULTS

**Project Profile:** Competitive Testing in 4150 Steel  
**Tooling Solution:** GEN3SYS XT Pro: Steel (P) Geometry with XT Pro Holder

**The Parameters:**

- Hole Diameter = 0.748" (19mm)
- Depth of Cut = 1-1/2" (38.1mm)
- Coolant = 300 PSI
- Speed = 1583 RPM
- Feed = 22.16 inch/min (563 mm/min)

**The Results:**  
 When run at the listed parameters, here is how the 3 different tooling solutions performed:

**Competitor 1** = 2478 total linear inches  
**Competitor 2** = 3317 total linear inches  
**GEN3SYS XT Pro** = 4224 total linear inches

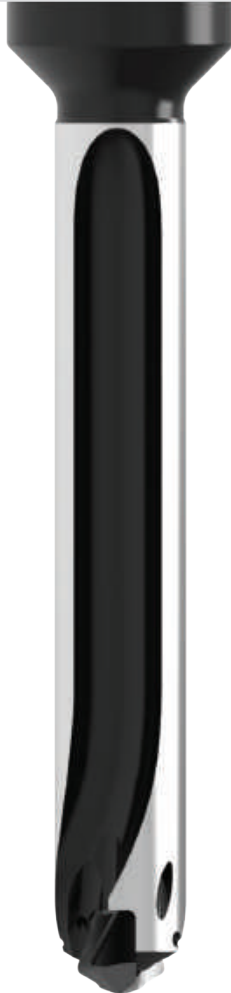

**Average Tool Life**  
 Test Results Drilling in 4150 Steel

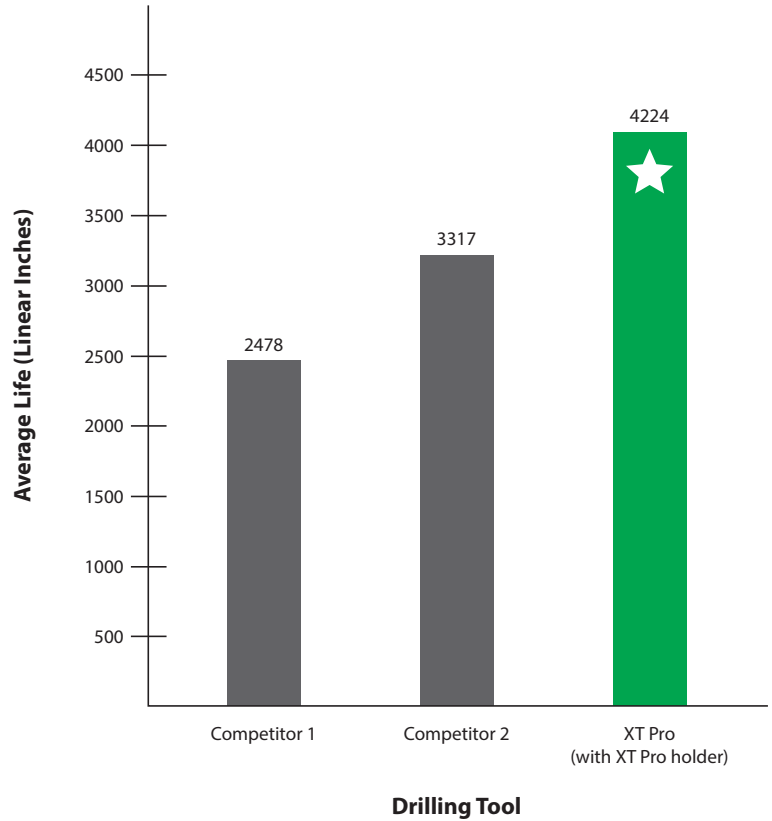

Case Study Example

# CASE STUDY

**Project Profile:** Ductile/Nodular Iron  
**Tooling Solution:** GEN3SYS XT Pro: K (Cast Iron) Geometry

**The Problem:**  
 Previously, the customer was using a competitor drill:  
 • Solid carbide drill  
 • Tool life = **65 holes**

**The Solution:**  
 Allied Machine recommended the GEN3SYS XT Pro with K (Cast Iron) geometry.  
 The tool ran at the following parameters:  
 • Hole Diameter = 9/16"  
 • Coolant = None  
 • Speed = 390 SFM (117 M/min)  
 • Feed = 0.008 IPR (0.20 mm/rev)  
 • Tool life = **390 holes**

**The Advantage:**  
 The GEN3SYS XT Pro increased the tool life from 65 holes to 390 holes.  
**Bottom Line:** *6x the tool life*

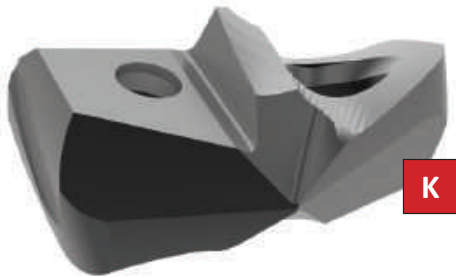

## The PROOF is in the NUMBERS

**Competitor Tool Life**  
 (number of holes = 65)



**XT Pro Tool Life**  
 (number of holes = 390)

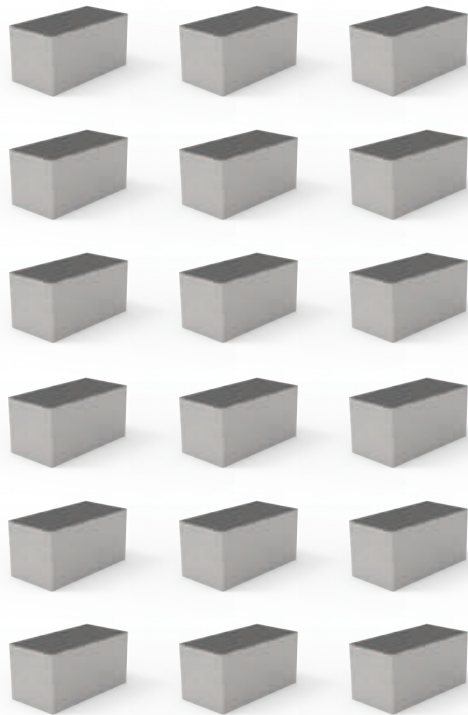

### There's More to the Advantage than Tool Life

The XT Pro replaceable tip system provides other benefits in addition to the increase in tool life over the solid carbide drill:

- Because only the insert needs changed when it reaches the end of its life, the XT Pro eliminates the need to re-establish tool lengths, which reduces set-up times.
- Further benefit in set-up is also seen as the tool only needs changed one time for every six of the customer's current method.
- Without the need for regrinds, the customer's stock of tooling is reduced by eliminating the need for float inventory to cover regrind lead time.

**INCREASE** in  
**6x** tool life

## GEN3SYS XT Pro Drilling System Information

A DRILLING  
B BORING  
C REAMING  
D BURISHING  
E THREADING  
X SPECIALS

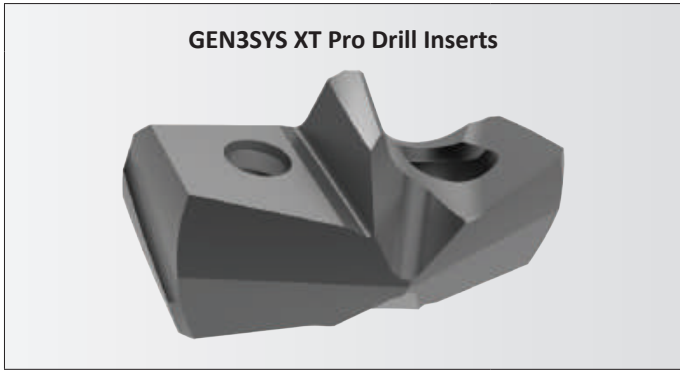

### Advanced Design Capabilities

The advanced XT Pro insert combines a coating and geometry specifically designed to achieve optimal results in ISO material drilling applications. With quick connectivity to existing GEN3SYS drill insert holders, the XT Pro insert can be interchanged with previous XT inserts with ease, resulting in minimal set-up times so you can immediately increase your productivity.

#### XT Pro Inserts Connect with:



XT Pro holders

GEN3SYS holders

#### P - Steels

- Designed to provide increased penetration rates and tool life in steel applications
- Superior geometry and edge provides excellent chip control
- Allied's multi-layer AM420 coating increases heat resistance and improves tool life

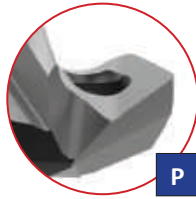

P

#### N - Non-ferrous Materials

- Designed for applications in aluminum, brass, and copper
- The geometry yields excellent chip control in these softer materials
- TiN coating gives the versatility to run in a variety of materials while reducing build up

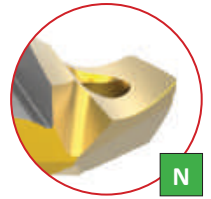

N

#### K - Cast Irons

- Uniquely designed for cast/nodular iron applications
- Geometry includes a corner radius for improved hole finish and heat dispersion
- Allied's multi-layer AM440 coating provides increased abrasion resistance and tool life



K

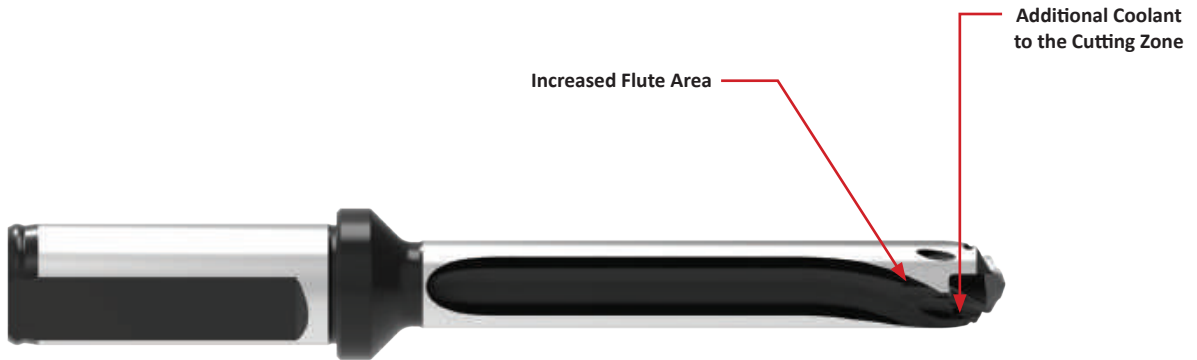

### XT Pro Drill Holders

			<p><b>3xD, 5xD, 7xD, 10xD</b></p>
<p>Straight flutes</p>	<p>Enhanced coolant inlets improve the coolant flow</p>	<p>Provides increased insert life</p>	<p>Available in 3xD, 5xD, 7xD, and 10xD</p>



## GEN3SYS XT Drilling System Information

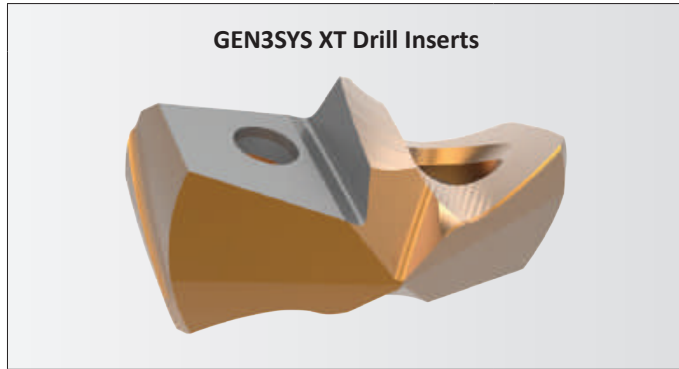

### High Penetration Drilling Solutions

The unique geometry of the XT inserts provides excellent chip control. They are designed to increase hole quality, surface finish, and true position when compared to other competitive products. The helical margin design provides maximum durability and stability.

#### XT Inserts Connect with:



#### Standard Geometry

- Designed with corner and cutting edge enhancements to deliver more reliability, durability, and productivity
- Increases penetration rates and tool life
- Available in C1 or C2 carbide

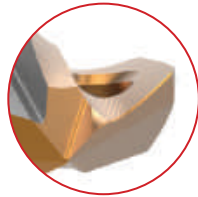

#### LR - Low Rake Geometry

- The toughest XT geometry available
- Designed for harder steels and less than ideal machining applications
- Available in C1 or C2 carbide

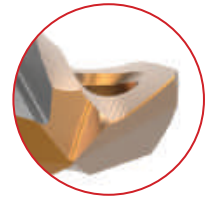

#### CI - Cast Iron Geometry

- Increases durability and tool life in ductile, nodular, and grey cast irons
- Available in C2 carbide



#### AS - Stainless Steel Geometry

- Designed with a specific geometry to provide unmatched chip control and tool life in austenitic and PH stainless steels, as well as high temperature alloys such as Inconel, Hastelloy, and Titanium alloys
- Available in C2 carbide

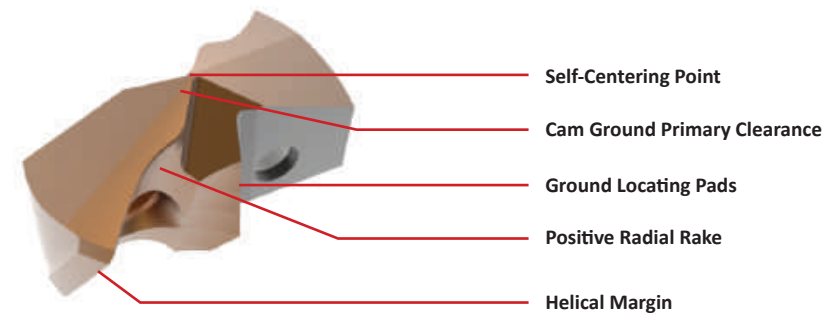
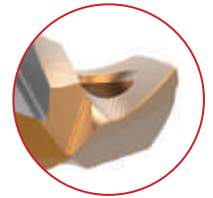

Coating	Features / Benefits
AM300®	<ul style="list-style-type: none"> <li>• Increased heat resistance over AM200® coating</li> <li>• Up to 20% increased tool life over AM200 coating</li> <li>• Provides superior tool life at high penetration rates</li> </ul>



### GEN3SYS Holders

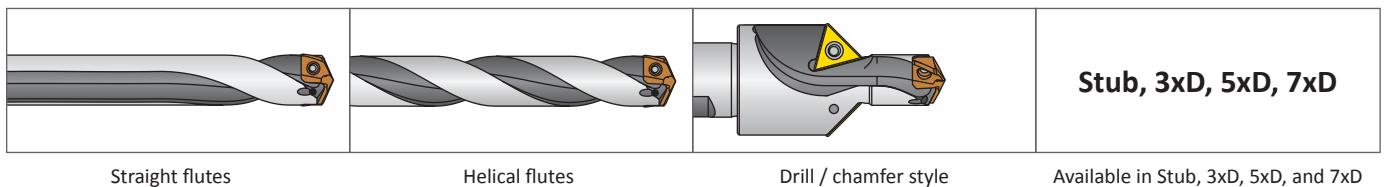





Straight flutes

Helical flutes

Drill / chamfer style

Available in Stub, 3xD, 5xD, and 7xD

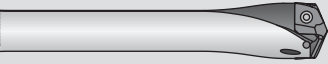
## Insert Comparison and Assembly Information

		XT Pro Inserts	XT Inserts
B BORING	Recommended for increased productivity		<input checked="" type="checkbox"/>
	ISO specific geometry/coating combination		<input checked="" type="checkbox"/>
	Connects with XT Pro holders		<input checked="" type="checkbox"/>
C REAMING	Connects with GEN3SYS holders		<input checked="" type="checkbox"/>



**Step 1:**  
Align the flats on the GEN3SYS XT insert with the flats on the ears of the holder.







**Step 2:**  
Slide the insert into the precision ground locating pocket on the holder. The insert should not be turned, rotated, or twisted for locking purposes. The holder pocket and locating pads on the insert assure optimum fit and repeatability.

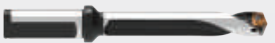

**Step 3:**  
Apply a generous amount of E-Z Break® (provided in the packaging) onto the supplied TORX® Plus screws.

Tighten the TORX Plus screws to the recommended torque value specified in the catalog by series. A preset torx driver is available to assure that the proper torque is applied.

## Holder Comparison and Overview

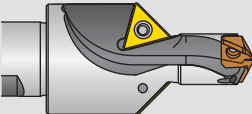
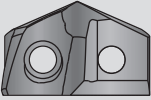
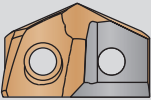
		 XT Pro Holders	 GEN3SYS Holders
Recommended for increased productivity		<input checked="" type="checkbox"/>	
Straight flute		<input checked="" type="checkbox"/>	<input checked="" type="checkbox"/>
Helical flute			<input checked="" type="checkbox"/>
Drill/chamfer option			<input checked="" type="checkbox"/>
Available in 10xD length	<b>10XD</b>	<input checked="" type="checkbox"/>	
Connects with XT Pro inserts		<input checked="" type="checkbox"/>	<input checked="" type="checkbox"/>
Connects with XT inserts		<input checked="" type="checkbox"/>	<input checked="" type="checkbox"/>

### XT Pro Holders



Straight Flute

### GEN3SYS Holders



Straight Flute



Helical Flute



Drill/Chamfer

## Product Nomenclature

### GEN3SYS XT Pro Drill Inserts

<b>XT</b>	<b>P</b>	<b>11</b>	–	<b>11.00</b>
1	2	3		4

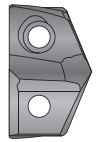

1. XT Pro Drill Insert	2. ISO Material / Geometry	3. Series	4. Diameter (mm)
XT = XT Pro insert	P = Steel K = Cast iron N = Non-ferrous	11 = 11 series      18 = 18 series 12 = 12 series      20 = 20 series 13 = 13 series      22 = 22 series 14 = 14 series      24 = 24 series 15 = 15 series      26 = 26 series 16 = 16 series      29 = 29 series 17 = 17 series      32 = 32 series	For complete list of diameter ranges by series, see contents page.

### GEN3SYS XT Drill Inserts

<b>7</b>	<b>C2</b>	<b>12</b>	<b>P</b>	–	<b>.484</b>	<b>CI</b>
1	2	3	4		5	6

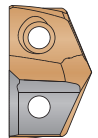

1. XT Drill Insert	2. Insert Material	3. Series	4. Coating
7 = XT insert	C1 = C1 (K35) carbide C2 = C2 (K20) carbide	11 = 11 series      18 = 18 series 12 = 12 series      20 = 20 series 13 = 13 series      22 = 22 series 14 = 14 series      24 = 24 series 15 = 15 series      26 = 26 series 16 = 16 series      29 = 29 series 17 = 17 series      32 = 32 series	P = AM300®

5. Diameter	6. Geometry
0017 = Inch .515 = Decimal 13 = Metric	CI = Cast iron LR = Low rake AS = Stainless steel

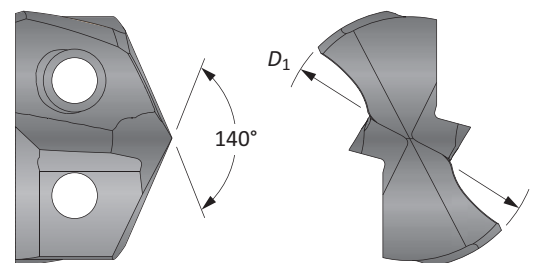

### Regrinding and Recoating

The GEN3SYS XT and XT Pro drilling system is so cost efficient that it eliminates the need for regrinding and recoating. However, if you choose to have your drill inserts reground, it is critical that it be done by Allied Machine. Any slight deviation in performance due to an improperly reground drill insert will more than offset any benefit from regrinding. Using our service ensures that the best tool performance is maintained in your production process. When returning tools for regrinding, please package tools carefully to avoid damage during shipment. Returning drill inserts for regrinding in their original packaging will help avoid damage during shipment. Drill inserts reground by Allied Machine are repackaged and clearly identified as "Allied Regrind" to avoid any confusion with new tools.

### Reference Key

Symbol	Attribute
$D_1$	Insert diameter

A DRILLING  
B BORING  
C REAMING  
D BURNISHING  
E THREADING  
X SPECIALS

## Product Nomenclature

### GEN3SYS and XT Pro Drill Holders

<b>HXT</b>	<b>03</b>	<b>12</b>	<b>S</b>	-	<b>20</b>	<b>FM</b>
1	2	3	4		5	6



<b>1. Holder</b> 6 = GEN3SYS holder HXT = XT Pro holder	<b>2. Length</b> 01 = Stub Length (standard only) 03 = 3x Diameter 05 = 5x Diameter 07 = 7x Diameter 10 = 10x Diameter (Pro only)	<b>3. Series</b> 11 = 11 series      18 = 18 series 12 = 12 series      20 = 20 series 13 = 13 series      22 = 22 series 14 = 14 series      24 = 24 series 15 = 15 series      26 = 26 series 16 = 16 series      29 = 29 series 17 = 17 series      32 = 32 series	<b>4. Flute</b> S = Straight H = Helical C45 = Drill/Chamfer (both helical and drill/chamfer options available for GEN3SYS only)										
<b>5. Shank Diameter</b> <table border="1"> <thead> <tr> <th>Imperial (inch)</th> <th>Metric (mm)</th> </tr> </thead> <tbody> <tr> <td>063 = 5/8"</td> <td>16 = 16mm</td> </tr> <tr> <td>075 = 3/4"</td> <td>20 = 20mm</td> </tr> <tr> <td>100 = 1"</td> <td>25 = 25mm</td> </tr> <tr> <td>125 = 1-1/4"</td> <td>32 = 32mm</td> </tr> <tr> <td>150 = 1-1/2"</td> <td>40 = 40mm</td> </tr> </tbody> </table>	Imperial (inch)	Metric (mm)	063 = 5/8"	16 = 16mm	075 = 3/4"	20 = 20mm	100 = 1"	25 = 25mm	125 = 1-1/4"	32 = 32mm	150 = 1-1/2"	40 = 40mm	<b>6. Shank Style</b> F = Flanged with flat FM = Flanged metric with flat C = Cylindrical (no flat) CM = Cylindrical metric (no flat)
Imperial (inch)	Metric (mm)												
063 = 5/8"	16 = 16mm												
075 = 3/4"	20 = 20mm												
100 = 1"	25 = 25mm												
125 = 1-1/4"	32 = 32mm												
150 = 1-1/2"	40 = 40mm												

#### Holder Ordering Information

The series designator (11 series, 12 series, etc.) in the top corner of each page is for your reference when ordering. Please refer to these series designators when placing an order. For example, a 12 series drill insert only fits into a 12 series holder.

#### Reference Key

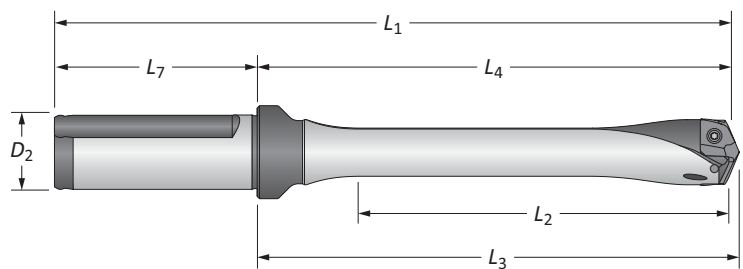

Symbol	Attribute
$D_2$	Shank diameter
$D_5$	Step diameter (drill/chamfer)
$L_1$	Overall length
$L_2$	Drill depth
$L_3$	Holder reference length
$L_4$	Holder body length
$L_5$	Step length (drill/chamfer)
$L_7$	Shank length
$P_1$	Rear pipe tap (GEN3SYS)

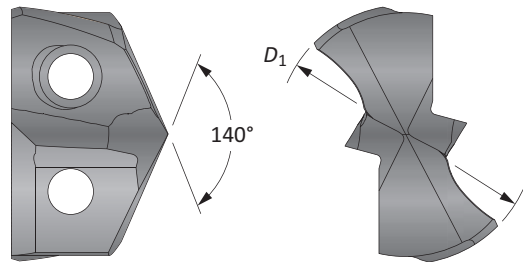
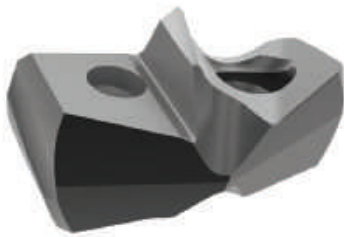

## GEN3SYS XT Pro Drill Inserts

11 Series | Diameter Range: 0.4331" - 0.4723" (11.00mm - 11.99mm)



Fractional Equivalent	Insert				
	$D_1$ inch	$D_1$ mm	Part No. <b>P</b>	Part No. <b>K</b>	Part No. <b>N</b>
-	0.4331	11.00	XTP11-11.00	XTK11-11.00	XTN11-11.00
7/16	0.4375	11.11	XTP11-11.11	XTK11-11.11	XTN11-11.11
-	0.4409	11.20	XTP11-11.20	XTK11-11.20	XTN11-11.20
-	0.4449	11.30	XTP11-11.30	XTK11-11.30	XTN11-11.30
-	0.4488	11.40	XTP11-11.40	XTK11-11.40	XTN11-11.40
-	0.4528	11.50	XTP11-11.50	XTK11-11.50	XTN11-11.50
29/64	0.4531	11.51	XTP11-11.51	XTK11-11.51	XTN11-11.51
-	0.4567	11.60	XTP11-11.60	XTK11-11.60	XTN11-11.60
-	0.4606	11.70	XTP11-11.70	XTK11-11.70	XTN11-11.70
-	0.4646	11.80	XTP11-11.80	XTK11-11.80	XTN11-11.80
15/32	0.4688	11.91	XTP11-11.91	XTK11-11.91	XTN11-11.91

Inserts sold in multiples of 1

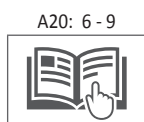
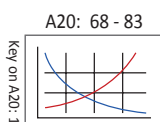

Sizes not shown are available upon request. When ordering, please follow the example below:	
<b>Imperial:</b>	0.5180", Steel, 13 series = use Part No. <b>XTP13-13.16</b>
<b>Metric:</b>	13.16mm, Steel, 13 series = use Part No. <b>XTP13-13.16</b>

### GEN3SYS XT Pro Drill Insert Holders

11 Series | Diameter Range: 0.4331" - 0.4723" (11.00mm - 11.99mm)

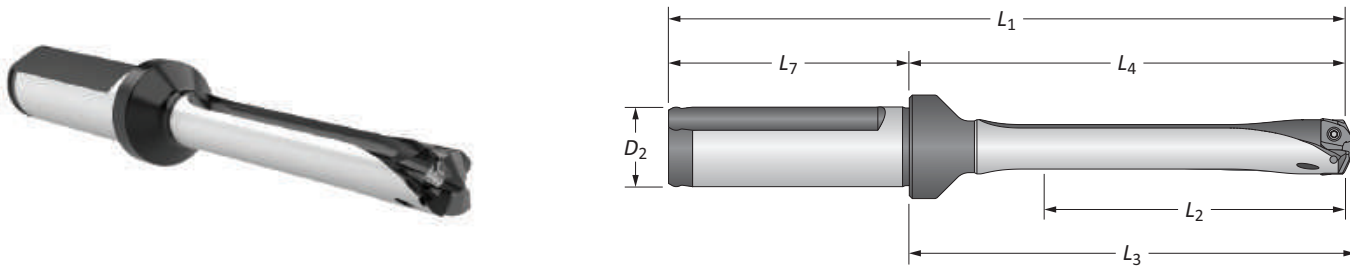

Flute	Body					Shank			Part No.
	Length	L <sub>2</sub>	L <sub>4</sub>	L <sub>3</sub>	L <sub>1</sub>	L <sub>7</sub>	D <sub>2</sub>	Flat	
i Straight 	3xD	1-27/64	2-29/64	2-17/32	4-21/64	1-7/8	5/8	YES	HXT0311S-063F
	3xD	1-27/64	2-29/64	2-17/32	4-21/64	1-7/8	5/8	NO	HXT0311S-063C
	5xD	2-23/64	3-13/32	3-31/64	5-9/32	1-7/8	5/8	YES	HXT0511S-063F
	5xD	2-23/64	3-13/32	3-31/64	5-9/32	1-7/8	5/8	NO	HXT0511S-063C
	7xD	3-19/64	4-11/32	4-27/64	6-7/32	1-7/8	5/8	YES	HXT0711S-063F
	7xD	3-19/64	4-11/32	4-27/64	6-7/32	1-7/8	5/8	NO	HXT0711S-063C
	10xD	4-23/32	5-49/64	5-27/32	7-41/64	1-7/8	5/8	YES	HXT1011S-063F
10xD	4-23/32	5-49/64	5-27/32	7-41/64	1-7/8	5/8	NO	HXT1011S-063C	
iii Straight 	3xD	36.0	62.6	64.4	110.6	48.0	16.0	YES	HXT0311S-16FM
	3xD	36.0	62.6	64.4	110.6	48.0	16.0	NO	HXT0311S-16CM
	5xD	60.0	86.6	88.4	134.6	48.0	16.0	YES	HXT0511S-16FM
	5xD	60.0	86.6	88.4	134.6	48.0	16.0	NO	HXT0511S-16CM
	7xD	83.7	110.6	112.4	158.6	48.0	16.0	YES	HXT0711S-16FM
	7xD	83.7	110.6	112.4	158.6	48.0	16.0	NO	HXT0711S-16CM
	10xD	119.9	146.6	148.4	194.6	48.0	16.0	YES	HXT1011S-16FM
	10xD	119.9	146.6	148.4	194.6	48.0	16.0	NO	HXT1011S-16CM

#### Connection Accessories

				<b>Admissible Tightening Torque*</b>
71843-IP6-1	8IP-6	8IP-6TL	8IP-6B	4.4 in-lbs (50 N-cm)

\*Tightening torques are calculated with a friction coefficient of  $\mu = 0.14$  and develop 90% of ultimate yield strength

**⚠ WARNING** Refer to Speed and Feed charts for recommended adjustments to speeds and feeds. Refer to page A20: 86 for deep hole drilling guidelines in this section of the catalog. Visit [www.alliedmachine.com/DeepHoleGuidelines](http://www.alliedmachine.com/DeepHoleGuidelines) for the most up-to-date information and procedures. Factory technical assistance is available for your specific applications through our Application Engineering Team.

i = Imperial (in)  
iii = Metric (mm)





Screws sold in multiples of 10

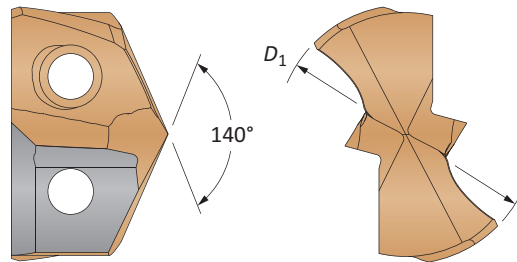
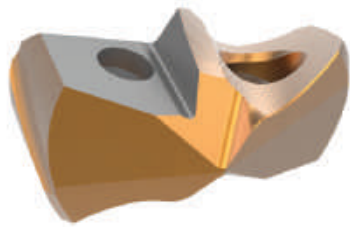

## GEN3SYS XT Drill Inserts

11 Series | Diameter Range: 0.4331" - 0.4723" (11.00mm - 11.99mm)



Carbide Substrate	Insert			 Standard Part No.	 Low Rake Part No.	 Cast Iron Part No.	 Stainless Part No.
	Fractional Equivalent	D <sub>1</sub> inch	D <sub>1</sub> mm				
C1 (K35)	-	0.4331	11.00	<b>7C111P-11</b>	<b>7C111P-11LR</b>	-	-
	7/16	0.4375	11.11	<b>7C111P-0014</b>	<b>7C111P-0014LR</b>	-	-
	-	0.4528	11.50	<b>7C111P-11.5</b>	<b>7C111P-11.5LR</b>	-	-
	29/64	0.4531	11.51	<b>7C111P-.453</b>	<b>7C111P-.453LR</b>	-	-
	15/32	0.4688	11.91	<b>7C111P-0015</b>	<b>7C111P-0015LR</b>	-	-
C2 (K20)	-	0.4331	11.00	<b>7C211P-11</b>	<b>7C211P-11LR</b>	<b>7C211P-11CI</b>	<b>7C211P-11AS</b>
	7/16	0.4375	11.11	<b>7C211P-0014</b>	<b>7C211P-0014LR</b>	<b>7C211P-0014CI</b>	<b>7C211P-0014AS</b>
	-	0.4528	11.50	<b>7C211P-11.5</b>	<b>7C211P-11.5LR</b>	<b>7C211P-11.5CI</b>	<b>7C211P-11.5AS</b>
	29/64	0.4531	11.51	<b>7C211P-.453</b>	<b>7C211P-.453LR</b>	<b>7C211P-.453CI</b>	<b>7C211P-.453AS</b>
	15/32	0.4688	11.91	<b>7C211P-0015</b>	<b>7C211P-0015LR</b>	<b>7C211P-0015CI</b>	<b>7C211P-0015AS</b>

Inserts sold in multiples of 1

A20: 68 - 83

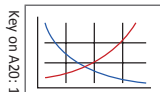

A20: 6 - 9



Sizes not shown are available upon request.

When ordering, please follow the example below:

<b>Imperial:</b>	0.5200", 13 series, C2 = use Part No. <b>7C213P-.5200</b>
<b>Metric:</b>	13.20mm, 13 series, C2 = use Part No. <b>7C213P-13.20</b>



## GEN3SYS Drill Insert Holders

11 Series | Diameter Range: 0.4331" - 0.4723" (11.00mm - 11.99mm)

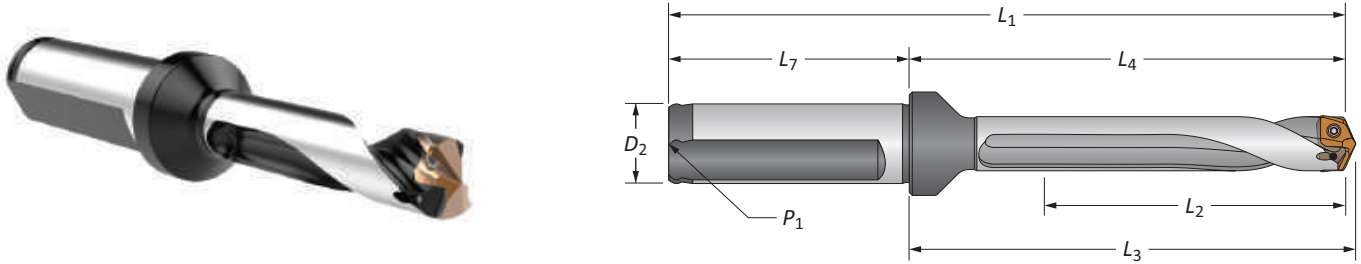

### Straight and Helical

Flute	Length	Body				Shank				Flat	Part No.
		L <sub>2</sub>	L <sub>4</sub>	L <sub>3</sub>	L <sub>1</sub>	L <sub>7</sub>	D <sub>2</sub>	P <sub>1</sub>			
	3xD	1-27/64	2-29/64	2-17/32	4-21/64	1-7/8	5/8	1/16	YES	<b>60311S-063F</b>	
	5xD	2-23/64	3-13/32	3-31/64	5-9/32	1-7/8	5/8	1/16	YES	<b>60511S-063F</b>	
	7xD	3-19/64	4-11/32	4-27/64	6-7/32	1-7/8	5/8	1/16	YES	<b>60711S-063F</b>	
	Stub	5/8	1-43/64	1-3/4	3-35/64	1-7/8	5/8	1/16	YES	<b>60111H-063F</b>	
	3xD	1-27/64	2-29/64	2-17/32	4-21/64	1-7/8	5/8	1/16	YES	<b>60311H-063F</b>	
	3xD	1-27/64	2-29/64	2-17/32	4-21/64	1-7/8	5/8	1/16	NO	<b>60311H-063C</b>	
	5xD	2-23/64	3-13/32	3-31/64	5-9/32	1-7/8	5/8	1/16	YES	<b>60511H-063F</b>	
	5xD	2-23/64	3-13/32	3-31/64	5-9/32	1-7/8	5/8	1/16	NO	<b>60511H-063C</b>	
	7xD	3-19/64	4-11/32	4-27/64	6-7/32	1-7/8	5/8	1/16	YES	<b>60711H-063F</b>	
	7xD	3-19/64	4-11/32	4-27/64	6-7/32	1-7/8	5/8	1/16	NO	<b>60711H-063C</b>	
	3xD	36.0	62.6	64.4	110.6	48.0	16.0	1/16*	YES	<b>60311S-16FM</b>	
	5xD	60.0	86.6	88.4	134.6	48.0	16.0	1/16*	YES	<b>60511S-16FM</b>	
	7xD	83.7	110.6	112.4	158.6	48.0	16.0	1/16*	YES	<b>60711S-16FM</b>	
	Stub	16.0	42.6	44.7	90.6	48.0	16.0	1/16*	YES	<b>60111H-16FM</b>	
	3xD	36.0	62.6	64.4	110.6	48.0	16.0	1/16*	YES	<b>60311H-16FM</b>	
	3xD	36.0	62.6	64.4	110.6	48.0	16.0	1/16*	NO	<b>60311H-16CM</b>	
	5xD	60.0	86.6	88.4	134.6	48.0	16.0	1/16*	YES	<b>60511H-16FM</b>	
	5xD	60.0	86.6	88.4	134.6	48.0	16.0	1/16*	NO	<b>60511H-16CM</b>	
	7xD	83.7	110.6	112.4	158.6	48.0	16.0	1/16*	YES	<b>60711H-16FM</b>	
	7xD	83.7	110.6	112.4	158.6	48.0	16.0	1/16*	NO	<b>60711H-16CM</b>	

\*Thread to BSP and ISO 7-1

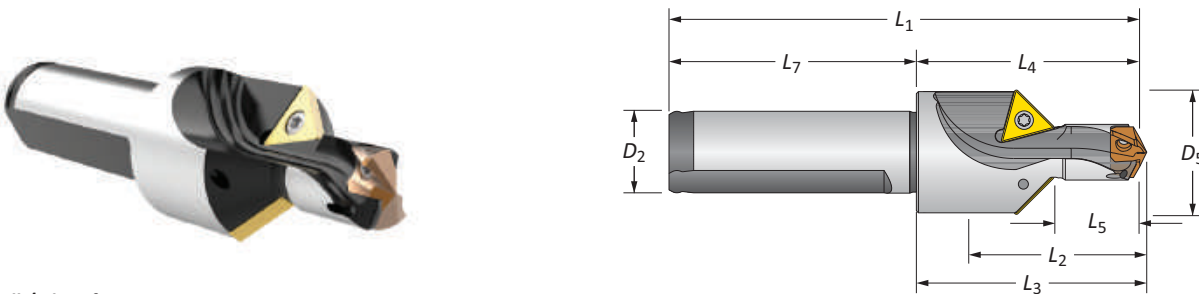

### Drill / Chamfer

	Step		Body				Shank		Part No.	Chamfer Insert
	D <sub>5</sub>	L <sub>5</sub>	L <sub>2</sub>	L <sub>4</sub>	L <sub>3</sub>	L <sub>1</sub>	L <sub>7</sub>	D <sub>2</sub>		
<b>i</b>	61/64	21/32	15/16	1-43/64	1-3/4	3-35/64	1-7/8	5/8	<b>60111C45-063F</b>	TCMT-110204
<b>m</b>	24.1	16.5	23.8	42.2	44.3	90.2	48.0	16.0	<b>60111C45-16FM</b>	TCMT-110204

### Connection Accessories

Insert Screws	Insert Driver	Preset Torque Hand Driver	Replacement Tips	Admissible Tightening Torque*
71843-IP6-1	8IP-6	8IP-6TL	8IP-6B	4.4 in-lbs (50 N-cm)

\*Tightening torques are calculated with a friction coefficient of  $\mu = 0.14$  and develop 90% of ultimate yield strength



Chamfer inserts sold separately in multiples of 10 | Screws sold in multiples of 10

**i** = Imperial (in)  
**m** = Metric (mm)

## GEN3SYS XT Pro Drill Inserts

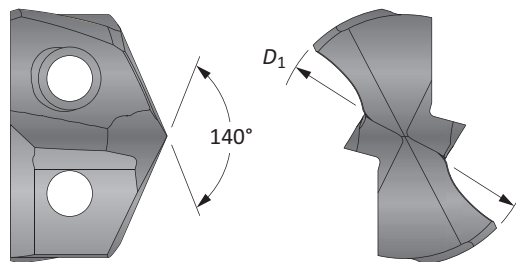
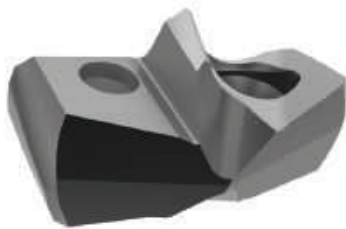
12 Series | Diameter Range: 0.4724" - 0.5117" (12.00mm - 12.99mm)



Fractional Equivalent	Insert				
	$D_1$ inch	$D_1$ mm	Part No. <b>P</b>	Part No. <b>K</b>	Part No. <b>N</b>
-	0.4724	12.00	XTP12-12.00	XTK12-12.00	XTN12-12.00
-	0.4764	12.10	XTP12-12.10	XTK12-12.10	XTN12-12.10
-	0.4803	12.20	XTP12-12.20	XTK12-12.20	XTN12-12.20
31/64	0.4844	12.30	XTP12-12.30	XTK12-12.30	XTN12-12.30
-	0.4882	12.40	XTP12-12.40	XTK12-12.40	XTN12-12.40
-	0.4921	12.50	XTP12-12.50	XTK12-12.50	XTN12-12.50
-	0.4961	12.60	XTP12-12.60	XTK12-12.60	XTN12-12.60
1/2	0.5000	12.70	XTP12-12.70	XTK12-12.70	XTN12-12.70
-	0.5039	12.80	XTP12-12.80	XTK12-12.80	XTN12-12.80
-	0.5079	12.90	XTP12-12.90	XTK12-12.90	XTN12-12.90

Inserts sold in multiples of 1

A20: 68 - 83

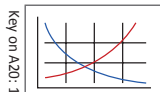

Key on A20: 1

A20: 6 - 9



Sizes not shown are available upon request.  
When ordering, please follow the example below:

<b>Imperial:</b>	0.5180", Steel, 13 series = use Part No. <b>XTP13-13.16</b>
<b>Metric:</b>	13.16mm, Steel, 13 series = use Part No. <b>XTP13-13.16</b>

### GEN3SYS XT Pro Drill Insert Holders

12 Series | Diameter Range: 0.4724" - 0.5117" (12.00mm - 12.99mm)

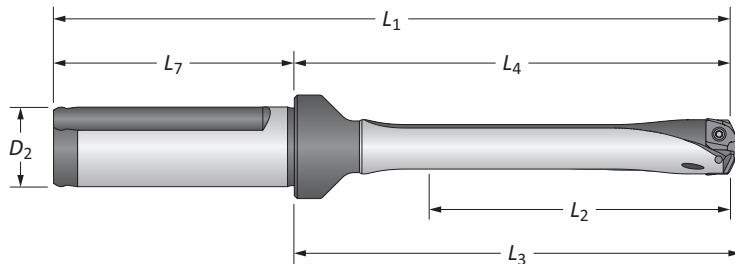

Flute	Body					Shank			Part No.
	Length	L <sub>2</sub>	L <sub>4</sub>	L <sub>3</sub>	L <sub>1</sub>	L <sub>7</sub>	D <sub>2</sub>	Flat	
i Straight	3xD	1-17/32	2-5/8	2-45/64	4-21/32	2-1/32	3/4	YES	HXT0312S-075F
	3xD	1-17/32	2-5/8	2-45/64	4-21/32	2-1/32	3/4	NO	HXT0312S-075C
	5xD	2-9/16	3-41/64	3-47/64	5-43/64	2-1/32	3/4	YES	HXT0512S-075F
	5xD	2-9/16	3-41/64	3-47/64	5-43/64	2-1/32	3/4	NO	HXT0512S-075C
	7xD	3-37/64	4-21/32	4-3/4	6-11/16	2-1/32	3/4	YES	HXT0712S-075F
	7xD	3-37/64	4-21/32	4-3/4	6-11/16	2-1/32	3/4	NO	HXT0712S-075C
	10xD	5-7/64	6-13/64	6-9/32	8-15/64	2-1/32	3/4	YES	HXT1012S-075F
10xD	5-7/64	6-13/64	6-9/32	8-15/64	2-1/32	3/4	NO	HXT1012S-075C	
m Straight	3xD	39.0	66.6	68.7	116.6	50.0	20.0	YES	HXT0312S-20FM
	3xD	39.0	66.6	68.7	116.6	50.0	20.0	NO	HXT0312S-20CM
	5xD	65.0	92.5	94.7	142.5	50.0	20.0	YES	HXT0512S-20FM
	5xD	65.0	92.5	94.7	142.5	50.0	20.0	NO	HXT0512S-20CM
	7xD	90.9	118.3	120.7	168.3	50.0	20.0	YES	HXT0712S-20FM
	7xD	90.9	118.3	120.7	168.3	50.0	20.0	NO	HXT0712S-20CM
	10xD	129.9	157.5	159.7	207.5	50.0	20.0	YES	HXT1012S-20FM
10xD	129.9	157.5	159.7	207.5	50.0	20.0	NO	HXT1012S-20CM	

#### Connection Accessories

					<b>Admissible Tightening Torque*</b>
7247-IP7-1	7247N-IP7-1	8IP-7	8IP-7TL	8IP-7B	7.4 in-lbs (84 N-cm)

\*Tightening torques are calculated with a friction coefficient of  $\mu = 0.14$  and develop 90% of ultimate yield strength

**⚠ WARNING** Refer to Speed and Feed charts for recommended adjustments to speeds and feeds. Refer to page A20: 86 for deep hole drilling guidelines in this section of the catalog. Visit [www.alliedmachine.com/DeepHoleGuidelines](http://www.alliedmachine.com/DeepHoleGuidelines) for the most up-to-date information and procedures. Factory technical assistance is available for your specific applications through our Application Engineering Team.

i = Imperial (in)  
m = Metric (mm)





Screws sold in multiples of 10

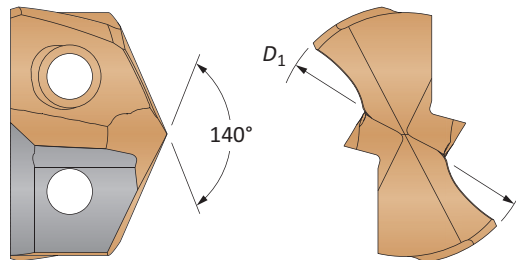
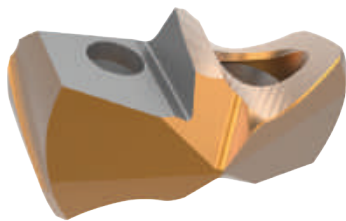

## GEN3SYS XT Drill Inserts

12 Series | Diameter Range: 0.4724" - 0.5117" (12.00mm - 12.99mm)



Carbide Substrate	Insert			 Standard Part No.	 Low Rake Part No.	 Cast Iron Part No.	 Stainless Part No.
	Fractional Equivalent	D <sub>1</sub> inch	D <sub>1</sub> mm				
C1 (K35)	-	0.4724	12.00	<b>7C112P-12</b>	<b>7C112P-12LR</b>	-	-
	31/64	0.4844	12.30	<b>7C112P-.484</b>	<b>7C112P-.484LR</b>	-	-
	-	0.4921	12.50	<b>7C112P-12.5</b>	<b>7C112P-12.5LR</b>	-	-
	1/2	0.5000	12.70	<b>7C112P-0016</b>	<b>7C112P-0016LR</b>	-	-
C2 (K20)	-	0.4724	12.00	<b>7C212P-12</b>	<b>7C212P-12LR</b>	<b>7C212P-12CI</b>	<b>7C212P-12AS</b>
	31/64	0.4844	12.30	<b>7C212P-.484</b>	<b>7C212P-.484LR</b>	<b>7C212P-.484CI</b>	<b>7C212P-.484AS</b>
	-	0.4921	12.50	<b>7C212P-12.5</b>	<b>7C212P-12.5LR</b>	<b>7C212P-12.5CI</b>	<b>7C212P-12.5AS</b>
	1/2	0.5000	12.70	<b>7C212P-0016</b>	<b>7C212P-0016LR</b>	<b>7C212P-0016CI</b>	<b>7C212P-0016AS</b>

Inserts sold in multiples of 1

A20: 68 - 83

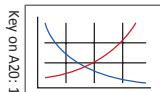

A20: 6 - 9



Sizes not shown are available upon request.  
When ordering, please follow the example below:

<b>Imperial:</b>	0.5200", 13 series, C2 = use Part No. <b>7C213P-.5200</b>
<b>Metric:</b>	13.20mm, 13 series, C2 = use Part No. <b>7C213P-13.20</b>

## GEN3SYS Drill Insert Holders

12 Series | Diameter Range: 0.4724" - 0.5117" (12.00mm - 12.99mm)

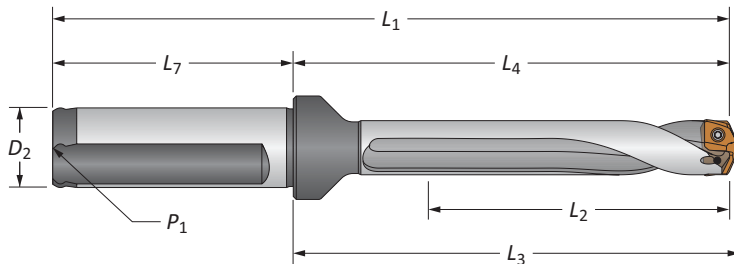

### Straight and Helical

Flute	Length	Body				Shank				Flat	Part No.
		L <sub>2</sub>	L <sub>4</sub>	L <sub>3</sub>	L <sub>1</sub>	L <sub>7</sub>	D <sub>2</sub>	P <sub>1</sub>			
	3xD	1-17/32	2-5/8	2-45/64	4-21/32	2-1/32	3/4	1/8	YES	<b>60312S-075F</b>	
	5xD	2-9/16	3-41/64	3-47/64	5-43/64	2-1/32	3/4	1/8	YES	<b>60512S-075F</b>	
	7xD	3-37/64	4-21/32	4-3/4	6-11/16	2-1/32	3/4	1/8	YES	<b>60712S-075F</b>	
	Stub	5/8	1-45/64	1-25/32	3-47/64	2-1/32	3/4	1/8	YES	<b>60112H-075F</b>	
	3xD	1-17/32	2-5/8	2-45/64	4-21/32	2-1/32	3/4	1/8	YES	<b>60312H-075F</b>	
	3xD	1-17/32	2-5/8	2-45/64	4-21/32	2-1/32	3/4	1/8	NO	<b>60312H-075C</b>	
	5xD	2-9/16	3-41/64	3-47/64	5-43/64	2-1/32	3/4	1/8	YES	<b>60512H-075F</b>	
	5xD	2-9/16	3-41/64	3-47/64	5-43/64	2-1/32	3/4	1/8	NO	<b>60512H-075C</b>	
	7xD	3-37/64	4-21/32	4-3/4	6-11/16	2-1/32	3/4	1/8	YES	<b>60712H-075F</b>	
	7xD	3-37/64	4-21/32	4-3/4	6-11/16	2-1/32	3/4	1/8	NO	<b>60712H-075C</b>	
	3xD	39.0	66.6	68.7	116.6	50.0	20.0	1/8*	YES	<b>60312S-20FM</b>	
	5xD	65.0	92.5	94.7	142.5	50.0	20.0	1/8*	YES	<b>60512S-20FM</b>	
	7xD	90.9	118.3	120.7	168.3	50.0	20.0	1/8*	YES	<b>60712S-20FM</b>	
	Stub	16.0	43.2	45.4	93.2	50.0	20.0	1/8*	YES	<b>60112H-20FM</b>	
	3xD	39.0	66.6	68.7	116.6	50.0	20.0	1/8*	YES	<b>60312H-20FM</b>	
	3xD	39.0	66.6	68.7	116.6	50.0	20.0	1/8*	NO	<b>60312H-20CM</b>	
	5xD	65.0	92.5	94.7	142.5	50.0	20.0	1/8*	YES	<b>60512H-20FM</b>	
	5xD	65.0	92.5	94.7	142.5	50.0	20.0	1/8*	NO	<b>60512H-20CM</b>	
	7xD	90.9	118.3	120.7	168.3	50.0	20.0	1/8*	YES	<b>60712H-20FM</b>	
	7xD	90.9	118.3	120.7	168.3	50.0	20.0	1/8*	NO	<b>60712H-20CM</b>	

\*Thread to BSP and ISO 7-1

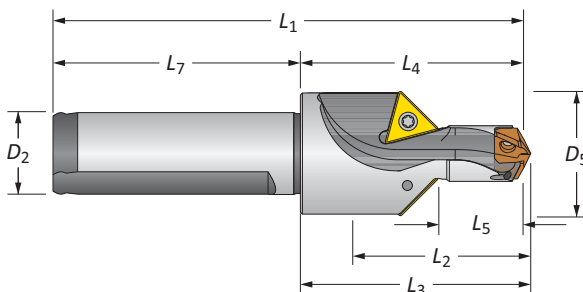

### Drill / Chamfer

	Step		Body				Shank		Part No.	Chamfer Insert
	D <sub>5</sub>	L <sub>5</sub>	L <sub>2</sub>	L <sub>4</sub>	L <sub>3</sub>	L <sub>1</sub>	L <sub>7</sub>	D <sub>2</sub>		
<b>i</b>	31/32	45/64	63/64	1-45/64	1-25/32	3-47/64	2-1/32	3/4	<b>60112C45-075F</b>	TCMT-110204
<b>m</b>	24.8	18.0	35.2	43.2	45.4	93.2	50.0	20.0	<b>60112C45-20FM</b>	TCMT-110204

### Connection Accessories

Insert Screws	Nylon Locking Screws	Insert Driver	Preset Torque Hand Driver	Replacement Tips	Admissible Tightening Torque*
7247-IP7-1	7247N-IP7-1	8IP-7	8IP-7TL	8IP-7B	7.4 in-lbs (84 N-cm)

\*Tightening torques are calculated with a friction coefficient of  $\mu = 0.14$  and develop 90% of ultimate yield strength



Chamfer inserts sold separately in multiples of 10 | Screws sold in multiples of 10

**i** = Imperial (in)  
**m** = Metric (mm)

## GEN3SYS XT Pro Drill Inserts

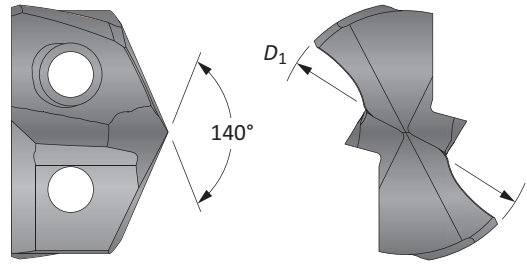
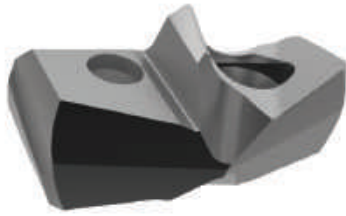
13 Series | Diameter Range: 0.5118" - 0.5511" (13.00mm - 13.99mm)



Fractional Equivalent	Insert				
	$D_1$ inch	$D_1$ mm	Part No. <b>P</b>	Part No. <b>K</b>	Part No. <b>N</b>
-	0.5118	13.00	XTP13-13.00	XTK13-13.00	XTN13-13.00
33/64	0.5156	13.10	XTP13-13.10	XTK13-13.10	XTN13-13.10
-	0.5197	13.20	XTP13-13.20	XTK13-13.20	XTN13-13.20
-	0.5236	13.30	XTP13-13.30	XTK13-13.30	XTN13-13.30
-	0.5276	13.40	XTP13-13.40	XTK13-13.40	XTN13-13.40
17/32	0.5313	13.49	XTP13-13.49	XTK13-13.49	XTN13-13.49
-	0.5315	13.50	XTP13-13.50	XTK13-13.50	XTN13-13.50
-	0.5354	13.60	XTP13-13.60	XTK13-13.60	XTN13-13.60
-	0.5394	13.70	XTP13-13.70	XTK13-13.70	XTN13-13.70
-	0.5433	13.80	XTP13-13.80	XTK13-13.80	XTN13-13.80
35/64	0.5469	13.89	XTP13-13.89	XTK13-13.89	XTN13-13.89

Inserts sold in multiples of 1

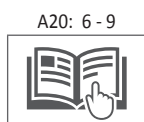
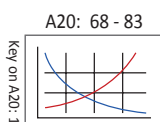

Sizes not shown are available upon request. When ordering, please follow the example below:	
<b>Imperial:</b>	0.5180", Steel, 13 series = use Part No. <b>XTP13-13.16</b>
<b>Metric:</b>	13.16mm, Steel, 13 series = use Part No. <b>XTP13-13.16</b>

GEN3SYS XT Pro Drill Insert Holders

13 Series | Diameter Range: 0.5118" - 0.5511" (13.00mm - 13.99mm)

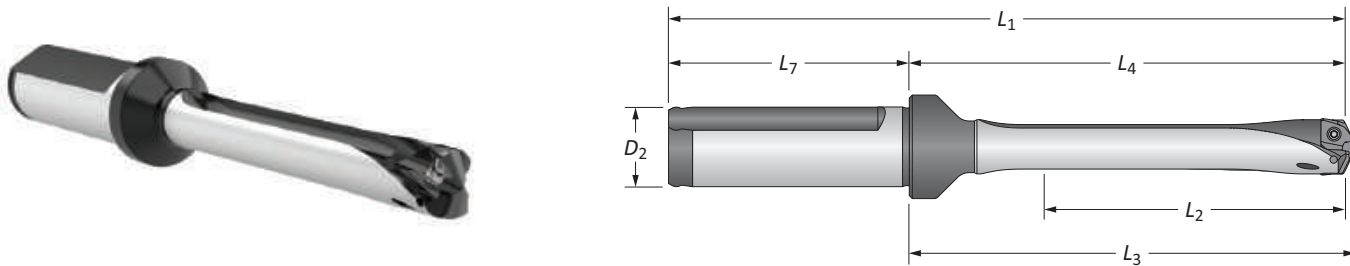

Flute	Body					Shank			Part No.
	Length	L <sub>2</sub>	L <sub>4</sub>	L <sub>3</sub>	L <sub>1</sub>	L <sub>7</sub>	D <sub>2</sub>	Flat	
i Straight	3xD	1-21/32	2-23/32	2-13/16	4-3/4	2-1/32	3/4	YES	HXT0313S-075F
	3xD	1-21/32	2-23/32	2-13/16	4-3/4	2-1/32	3/4	NO	HXT0313S-075C
	5xD	2-3/4	3-13/16	3-29/32	5-27/32	2-1/32	3/4	YES	HXT0513S-075F
	5xD	2-3/4	3-13/16	3-29/32	5-27/32	2-1/32	3/4	NO	HXT0513S-075C
	7xD	3-55/64	4-59/64	5-1/64	6-61/64	2-1/32	3/4	YES	HXT0713S-075F
	7xD	3-55/64	4-59/64	5-1/64	6-61/64	2-1/32	3/4	NO	HXT0713S-075C
	10xD	5-33/64	6-37/64	6-43/64	8-39/64	2-1/32	3/4	YES	HXT1013S-075F
10xD	5-33/64	6-37/64	6-43/64	8-39/64	2-1/32	3/4	NO	HXT1013S-075C	
ii Straight	3xD	42.0	69.0	71.4	119.0	50.0	20.0	YES	HXT0313S-20FM
	3xD	42.0	69.0	71.4	119.0	50.0	20.0	NO	HXT0313S-20CM
	5xD	69.9	96.8	99.2	146.8	50.0	20.0	YES	HXT0513S-20FM
	5xD	69.9	96.8	99.2	146.8	50.0	20.0	NO	HXT0513S-20CM
	7xD	98.0	125.0	127.4	175.0	50.0	20.0	YES	HXT0713S-20FM
	7xD	98.0	125.0	127.4	175.0	50.0	20.0	NO	HXT0713S-20CM
	10xD	140.0	167.0	169.4	217.0	50.0	20.0	YES	HXT1013S-20FM
	10xD	140.0	167.0	169.4	217.0	50.0	20.0	NO	HXT1013S-20CM

Connection Accessories

					Admissible Tightening Torque*
7247-IP7-1	7247N-IP7-1	8IP-7	8IP-7TL	8IP-7B	7.4 in-lbs (84 N-cm)

\*Tightening torques are calculated with a friction coefficient of  $\mu = 0.14$  and develop 90% of ultimate yield strength

**⚠ WARNING** Refer to Speed and Feed charts for recommended adjustments to speeds and feeds. Refer to page A20: 86 for deep hole drilling guidelines in this section of the catalog. Visit [www.alliedmachine.com/DeepHoleGuidelines](http://www.alliedmachine.com/DeepHoleGuidelines) for the most up-to-date information and procedures. Factory technical assistance is available for your specific applications through our Application Engineering Team.

i = Imperial (in)  
ii = Metric (mm)

Screws sold in multiples of 10



## GEN3SYS XT Drill Inserts

13 Series | Diameter Range: 0.5118" - 0.5511" (13.00mm - 13.99mm)

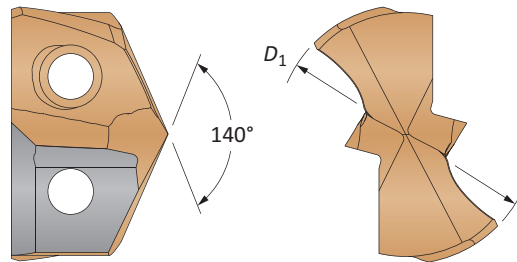
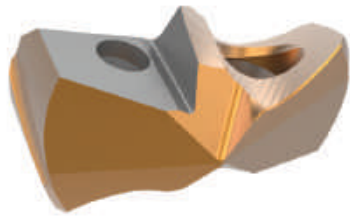

Carbide Substrate	Insert			Standard Part No.	Low Rake Part No.	Cast Iron Part No.	Stainless Part No.
	Fractional Equivalent	D <sub>1</sub> inch	D <sub>1</sub> mm				
C1 (K35)	-	0.5118	13.00	<b>7C113P-13</b>	<b>7C113P-13LR</b>	-	-
	33/64	0.5156	13.08	<b>7C113P-.515</b>	<b>7C113P-.515LR</b>	-	-
	17/32	0.5312	13.49	<b>7C113P-0017</b>	<b>7C113P-0017LR</b>	-	-
	-	0.5315	13.50	<b>7C113P-13.5</b>	<b>7C113P-13.5LR</b>	-	-
	35/64	0.5469	13.89	<b>7C113P-.546</b>	<b>7C113P-.546LR</b>	-	-
C2 (K20)	-	0.5118	13.00	<b>7C213P-13</b>	<b>7C213P-13LR</b>	<b>7C213P-13CI</b>	<b>7C213P-13AS</b>
	33/64	0.5156	13.08	<b>7C213P-.515</b>	<b>7C213P-.515LR</b>	<b>7C213P-.515CI</b>	<b>7C213P-.515AS</b>
	17/32	0.5312	13.49	<b>7C213P-0017</b>	<b>7C213P-0017LR</b>	<b>7C213P-0017CI</b>	<b>7C213P-0017AS</b>
	-	0.5315	13.50	<b>7C213P-13.5</b>	<b>7C213P-13.5LR</b>	<b>7C213P-13.5CI</b>	<b>7C213P-13.5AS</b>
	35/64	0.5469	13.89	<b>7C213P-.546</b>	<b>7C213P-.546LR</b>	<b>7C213P-.546CI</b>	<b>7C213P-.546AS</b>

Inserts sold in multiples of 1

A20: 68 - 83

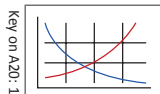

A20: 6 - 9



Sizes not shown are available upon request.

When ordering, please follow the example below:

<b>Imperial:</b>	0.5200", 13 series, C2 = use Part No. <b>7C213P-.5200</b>
<b>Metric:</b>	13.20mm, 13 series, C2 = use Part No. <b>7C213P-13.20</b>



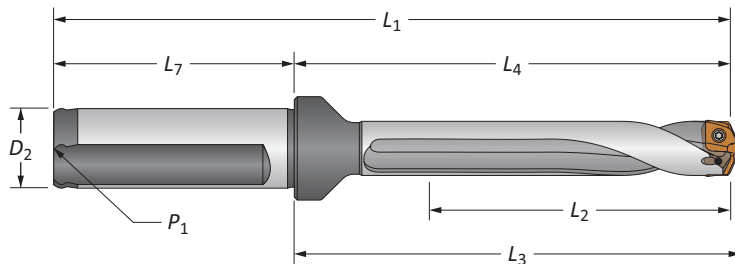

## GEN3SYS Drill Insert Holders

13 Series | Diameter Range: 0.5118" - 0.5511" (13.00mm - 13.99mm)



### Straight and Helical

Flute	Length	Body				Shank				Flat	Part No.
		L <sub>2</sub>	L <sub>4</sub>	L <sub>3</sub>	L <sub>1</sub>	L <sub>7</sub>	D <sub>2</sub>	P <sub>1</sub>			
	3xD	1-21/32	2-23/32	2-13/16	4-3/4	2-1/32	3/4	1/8	YES	<b>60313S-075F</b>	
	5xD	2-3/4	3-13/16	3-29/32	5-27/32	2-1/32	3/4	1/8	YES	<b>60513S-075F</b>	
	7xD	3-55/64	4-59/64	5-1/64	6-61/64	2-1/32	3/4	1/8	YES	<b>60713S-075F</b>	
	Stub	5/8	1-11/16	1-25/32	3-23/32	2-1/32	3/4	1/8	YES	<b>60113H-075F</b>	
	3xD	1-21/32	2-23/32	2-13/16	4-3/4	2-1/32	3/4	1/8	YES	<b>60313H-075F</b>	
	3xD	1-21/32	2-23/32	2-13/16	4-3/4	2-1/32	3/4	1/8	NO	<b>60313H-075C</b>	
	5xD	2-3/4	3-13/16	3-29/32	5-27/32	2-1/32	3/4	1/8	YES	<b>60513H-075F</b>	
	5xD	2-3/4	3-13/16	3-29/32	5-27/32	2-1/32	3/4	1/8	NO	<b>60513H-075C</b>	
	7xD	3-55/64	4-59/64	5-1/64	6-61/64	2-1/32	3/4	1/8	YES	<b>60713H-075F</b>	
	7xD	3-55/64	4-59/64	5-1/64	6-61/64	2-1/32	3/4	1/8	NO	<b>60713H-075C</b>	
	3xD	42.0	69.0	71.4	119.0	50.0	20.0	1/8*	YES	<b>60313S-20FM</b>	
	5xD	69.9	96.8	99.2	146.8	50.0	20.0	1/8*	YES	<b>60513S-20FM</b>	
	7xD	98.0	125.0	127.4	175.0	50.0	20.0	1/8*	YES	<b>60713S-20FM</b>	
	Stub	16.0	43.0	45.2	93.0	50.0	20.0	1/8*	YES	<b>60113H-20FM</b>	
	3xD	42.0	69.0	71.4	119.0	50.0	20.0	1/8*	YES	<b>60313H-20FM</b>	
	3xD	42.0	69.0	71.4	119.0	50.0	20.0	1/8*	NO	<b>60313H-20CM</b>	
	5xD	69.9	96.8	99.2	146.8	50.0	20.0	1/8*	YES	<b>60513H-20FM</b>	
	5xD	69.9	96.8	99.2	146.8	50.0	20.0	1/8*	NO	<b>60513H-20CM</b>	
	7xD	98.0	125.0	127.4	175.0	50.0	20.0	1/8*	YES	<b>60713H-20FM</b>	
	7xD	98.0	125.0	127.4	175.0	50.0	20.0	1/8*	NO	<b>60713H-20CM</b>	



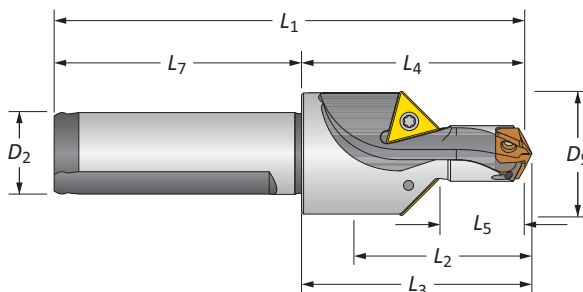

\*Thread to BSP and ISO 7-1



### Drill / Chamfer

	Step		Body				Shank		Part No.	 Chamfer Insert
	D <sub>5</sub>	L <sub>5</sub>	L <sub>2</sub>	L <sub>4</sub>	L <sub>3</sub>	L <sub>1</sub>	L <sub>7</sub>	D <sub>2</sub>		
<b>i</b>	1-1/64	49/64	1	1-11/16	1-25/32	3-23/32	2-1/32	3/4	<b>60113C45-075F</b>	TCMT-110204
<b>m</b>	25.8	19.5	25.4	43.0	45.2	93.0	50.0	20.0	<b>60113C45-20FM</b>	TCMT-110204

### Connection Accessories

 Insert Screws	 Nylon Locking Screws	 Insert Driver	 Preset Torque Hand Driver	 Replacement Tips	Admissible Tightening Torque*
7247-IP7-1	7247N-IP7-1	8IP-7	8IP-7TL	8IP-7B	7.4 in-lbs (84 N-cm)

\*Tightening torques are calculated with a friction coefficient of  $\mu = 0.14$  and develop 90% of ultimate yield strength



Chamfer inserts sold separately in multiples of 10 | Screws sold in multiples of 10

**i** = Imperial (in)  
**m** = Metric (mm)

## GEN3SYS XT Pro Drill Inserts

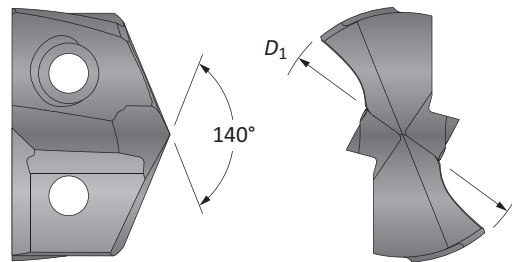
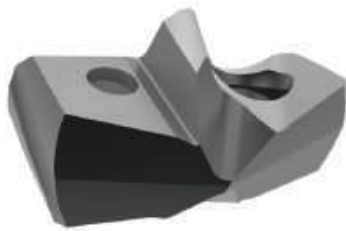
14 Series | Diameter Range: 0.5512" - 0.5905" (14.00mm - 14.99mm)



Fractional Equivalent	Insert				
	$D_1$ inch	$D_1$ mm	Part No. <b>P</b>	Part No. <b>K</b>	Part No. <b>N</b>
-	0.5512	14.00	XTP14-14.00	XTK14-14.00	XTN14-14.00
-	0.5551	14.10	XTP14-14.10	XTK14-14.10	XTN14-14.10
-	0.5591	14.20	XTP14-14.20	XTK14-14.20	XTN14-14.20
9/16	0.5625	14.29	XTP14-14.29	XTK14-14.29	XTN14-14.29
-	0.5669	14.40	XTP14-14.40	XTK14-14.40	XTN14-14.40
-	0.5709	14.50	XTP14-14.50	XTK14-14.50	XTN14-14.50
-	0.5748	14.60	XTP14-14.60	XTK14-14.60	XTN14-14.60
37/64	0.5781	14.68	XTP14-14.68	XTK14-14.68	XTN14-14.68
-	0.5827	14.80	XTP14-14.80	XTK14-14.80	XTN14-14.80
-	0.5866	14.90	XTP14-14.90	XTK14-14.90	XTN14-14.90

Inserts sold in multiples of 1

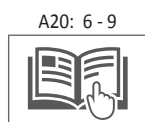
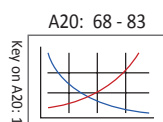

Sizes not shown are available upon request.	
When ordering, please follow the example below:	
<b>Imperial:</b>	0.5180", Steel, 13 series = use Part No. <b>XTP13-13.16</b>
<b>Metric:</b>	13.16mm, Steel, 13 series = use Part No. <b>XTP13-13.16</b>

### GEN3SYS XT Pro Drill Insert Holders

14 Series | Diameter Range: 0.5512" - 0.5905" (14.00mm - 14.99mm)

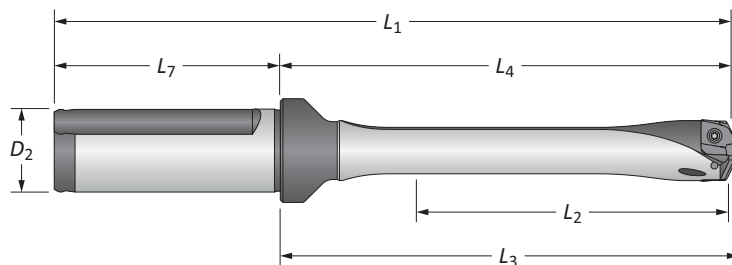

Flute	Body					Shank			Part No.
	Length	L <sub>2</sub>	L <sub>4</sub>	L <sub>3</sub>	L <sub>1</sub>	L <sub>7</sub>	D <sub>2</sub>	Flat	
i Straight 	3xD	1-49/64	2-27/32	2-61/64	4-7/8	2-1/32	3/4	YES	HXT0314S-075F
	3xD	1-49/64	2-27/32	2-61/64	4-7/8	2-1/32	3/4	NO	HXT0314S-075C
	5xD	2-61/64	4-1/32	4-1/8	6-1/16	2-1/32	3/4	YES	HXT0514S-075F
	5xD	2-61/64	4-1/32	4-1/8	6-1/16	2-1/32	3/4	NO	HXT0514S-075C
	7xD	4-1/8	5-13/64	5-5/16	7-15/64	2-1/32	3/4	YES	HXT0714S-075F
	7xD	4-1/8	5-13/64	5-5/16	7-15/64	2-1/32	3/4	NO	HXT0714S-075C
	10xD	5-29/32	6-63/64	7-5/64	9-1/64	2-1/32	3/4	YES	⚠ HXT1014S-075F
10xD	5-29/32	6-63/64	7-5/64	9-1/64	2-1/32	3/4	NO	⚠ HXT1014S-075C	
iii Straight 	3xD	44.8	72.2	74.9	122.2	50.0	20.0	YES	HXT0314S-20FM
	3xD	44.8	72.2	74.9	122.2	50.0	20.0	NO	HXT0314S-20CM
	5xD	75.0	102.4	104.9	152.4	50.0	20.0	YES	HXT0514S-20FM
	5xD	75.0	102.4	104.9	152.4	50.0	20.0	NO	HXT0514S-20CM
	7xD	104.8	132.2	134.8	182.2	50.0	20.0	YES	HXT0714S-20FM
	7xD	104.8	132.2	134.8	182.2	50.0	20.0	NO	HXT0714S-20CM
	10xD	149.9	177.4	179.8	227.4	50.0	20.0	YES	⚠ HXT1014S-20FM
	10xD	149.9	177.4	179.8	227.4	50.0	20.0	NO	⚠ HXT1014S-20CM

#### Connection Accessories

					<b>Admissible Tightening Torque*</b>
7247-IP7-1	7247N-IP7-1	8IP-7	8IP-7TL	8IP-7B	7.4 in-lbs (84 N-cm)

\*Tightening torques are calculated with a friction coefficient of  $\mu = 0.14$  and develop 90% of ultimate yield strength

**⚠ WARNING** Refer to Speed and Feed charts for recommended adjustments to speeds and feeds. Refer to page A20: 86 for deep hole drilling guidelines in this section of the catalog. Visit [www.alliedmachine.com/DeepHoleGuidelines](http://www.alliedmachine.com/DeepHoleGuidelines) for the most up-to-date information and procedures. Factory technical assistance is available for your specific applications through our Application Engineering Team.

i = Imperial (in)  
iii = Metric (mm)

Screws sold in multiples of 10



## GEN3SYS XT Drill Inserts

14 Series | Diameter Range: 0.5512" - 0.5905" (14.00mm - 14.99mm)

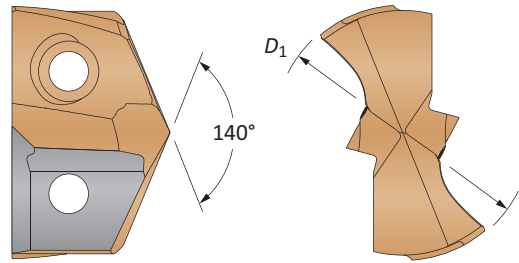
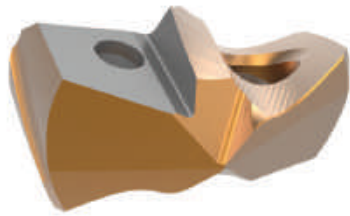

Carbide Substrate	Insert			Standard Part No.	Low Rake Part No.	Cast Iron Part No.	Stainless Part No.
	Fractional Equivalent	$D_1$ inch	$D_1$ mm				
C1 (K35)	-	0.5512	14.00	<b>7C114P-14</b>	<b>7C114P-14LR</b>	-	-
	9/16	0.5625	14.29	<b>7C114P-0018</b>	<b>7C114P-0018LR</b>	-	-
	-	0.5709	14.50	<b>7C114P-14.5</b>	<b>7C114P-14.5LR</b>	-	-
	37/64	0.5781	14.68	<b>7C114P-.578</b>	<b>7C114P-.578LR</b>	-	-
	-	0.5827	14.80	<b>7C114P-14.8</b>	<b>7C114P-14.8LR</b>	-	-
C2 (K20)	-	0.5512	14.00	<b>7C214P-14</b>	<b>7C214P-14LR</b>	<b>7C214P-14CI</b>	<b>7C214P-14AS</b>
	9/16	0.5625	14.29	<b>7C214P-0018</b>	<b>7C214P-0018LR</b>	<b>7C214P-0018CI</b>	<b>7C214P-0018AS</b>
	-	0.5709	14.50	<b>7C214P-14.5</b>	<b>7C214P-14.5LR</b>	<b>7C214P-14.5CI</b>	<b>7C214P-14.5AS</b>
	37/64	0.5781	14.68	<b>7C214P-.578</b>	<b>7C214P-.578LR</b>	<b>7C214P-.578CI</b>	<b>7C214P-.578AS</b>
	-	0.5827	14.80	<b>7C214P-14.8</b>	<b>7C214P-14.8LR</b>	<b>7C214P-14.8CI</b>	<b>7C214P-14.8AS</b>

Inserts sold in multiples of 1

A20: 68 - 83

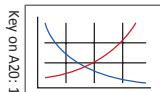

A20: 6 - 9



Sizes not shown are available upon request.  
When ordering, please follow the example below:

<b>Imperial:</b>	0.5200", 13 series, C2 = use Part No. <b>7C213P-.5200</b>
<b>Metric:</b>	13.20mm, 13 series, C2 = use Part No. <b>7C213P-13.20</b>

### GEN3SYS Drill Insert Holders

14 Series | Diameter Range: 0.5512" - 0.5905" (14.00mm - 14.99mm)

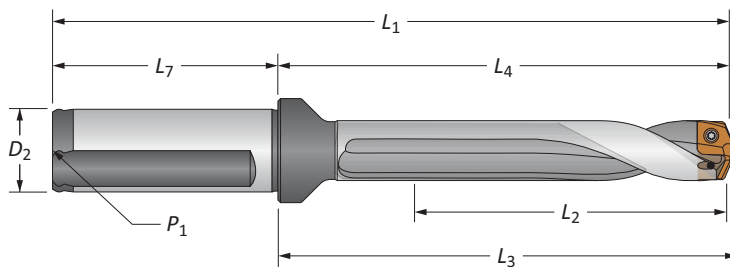

#### Straight and Helical

Flute	Length	Body				Shank				Flat	Part No.
		L <sub>2</sub>	L <sub>4</sub>	L <sub>3</sub>	L <sub>1</sub>	L <sub>7</sub>	D <sub>2</sub>	P <sub>1</sub>			
	3xD	1-49/64	2-27/32	2-61/64	4-7/8	2-1/32	3/4	1/8	YES	<b>60314S-075F</b>	
	5xD	2-61/64	4-1/32	4-1/8	6-1/16	2-1/32	3/4	1/8	YES	<b>60514S-075F</b>	
	7xD	4-1/8	5-13/64	5-5/16	7-15/64	2-1/32	3/4	1/8	YES	<b>60714S-075F</b>	
	Stub	11/16	1-3/4	1-55/64	3-25/32	2-1/32	3/4	1/8	YES	<b>60114H-075F</b>	
	3xD	1-49/64	2-27/32	2-61/64	4-7/8	2-1/32	3/4	1/8	YES	<b>60314H-075F</b>	
	3xD	1-49/64	2-27/32	2-61/64	4-7/8	2-1/32	3/4	1/8	NO	<b>60314H-075C</b>	
	5xD	2-61/64	4-1/32	4-1/8	6-1/16	2-1/32	3/4	1/8	YES	<b>60514H-075F</b>	
	5xD	2-61/64	4-1/32	4-1/8	6-1/16	2-1/32	3/4	1/8	NO	<b>60514H-075C</b>	
	7xD	4-1/8	5-13/64	5-5/16	7-15/64	2-1/32	3/4	1/8	YES	<b>60714H-075F</b>	
	7xD	4-1/8	5-13/64	5-5/16	7-15/64	2-1/32	3/4	1/8	NO	<b>60714H-075C</b>	
		3xD	44.8	72.2	74.9	122.2	50.0	20.0	1/8*	YES	<b>60314S-20FM</b>
5xD		75.0	102.4	104.9	152.4	50.0	20.0	1/8*	YES	<b>60514S-20FM</b>	
7xD		104.8	132.2	134.8	182.2	50.0	20.0	1/8*	YES	<b>60714S-20FM</b>	
Stub		17.5	44.5	47.2	94.5	50.0	20.0	1/8*	YES	<b>60114H-20FM</b>	
3xD		44.8	72.2	74.9	122.2	50.0	20.0	1/8*	YES	<b>60314H-20FM</b>	
3xD		44.8	72.2	74.9	122.2	50.0	20.0	1/8*	NO	<b>60314H-20CM</b>	
5xD		75.0	102.4	104.9	152.4	50.0	20.0	1/8*	YES	<b>60514H-20FM</b>	
5xD		75.0	102.4	104.9	152.4	50.0	20.0	1/8*	NO	<b>60514H-20CM</b>	
7xD		104.8	132.2	134.8	182.2	50.0	20.0	1/8*	YES	<b>60714H-20FM</b>	
7xD		104.8	132.2	134.8	182.2	50.0	20.0	1/8*	NO	<b>60714H-20CM</b>	

\*Thread to BSP and ISO 7-1

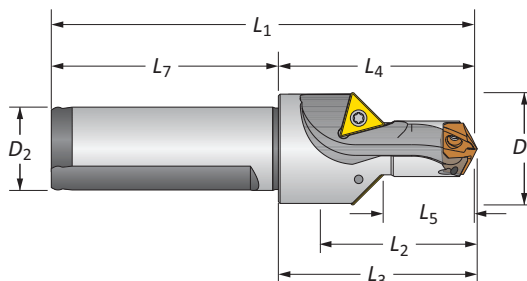

#### Drill / Chamfer

	Step		Body				Shank		Part No.	Chamfer Insert
	D <sub>5</sub>	L <sub>5</sub>	L <sub>2</sub>	L <sub>4</sub>	L <sub>3</sub>	L <sub>1</sub>	L <sub>7</sub>	D <sub>2</sub>		
	1-3/64	53/64	1-3/64	1-3/4	1-55/64	3-25/32	2-1/32	3/4	<b>60114C45-075F</b>	TCMT-110204
	26.7	21.0	26.8	44.6	47.2	94.6	50.0	20.0	<b>60114C45-20FM</b>	TCMT-110204

#### Connection Accessories

Insert Screws	Nylon Locking Screws	Insert Driver	Preset Torque Hand Driver	Replacement Tips	Admissible Tightening Torque*
7247-IP7-1	7247N-IP7-1	8IP-7	8IP-7TL	8IP-7B	7.4 in-lbs (84 N-cm)

\*Tightening torques are calculated with a friction coefficient of  $\mu = 0.14$  and develop 90% of ultimate yield strength



Chamfer inserts sold separately in multiples of 10 | Screws sold in multiples of 10

= Imperial (in)  
 = Metric (mm)

## GEN3SYS XT Pro Drill Inserts

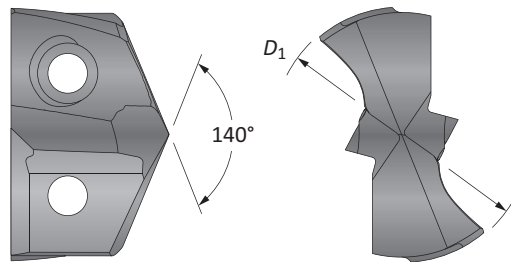
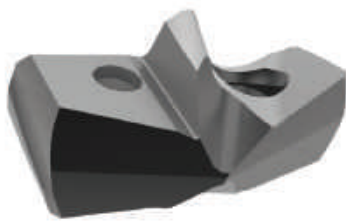
15 Series | Diameter Range: 0.5906" - 0.6298" (15.00mm - 15.99mm)



Fractional Equivalent	Insert				
	$D_1$ inch	$D_1$ mm	Part No. <b>P</b>	Part No. <b>K</b>	Part No. <b>N</b>
-	0.5906	15.00	XTP15-15.00	XTK15-15.00	XTN15-15.00
19/32	0.5938	15.08	XTP15-15.08	XTK15-15.08	XTN15-15.08
-	0.5984	15.20	XTP15-15.20	XTK15-15.20	XTN15-15.20
-	0.6024	15.30	XTP15-15.30	XTK15-15.30	XTN15-15.30
-	0.6063	15.40	XTP15-15.40	XTK15-15.40	XTN15-15.40
39/64	0.6094	15.48	XTP15-15.48	XTK15-15.48	XTN15-15.48
-	0.6102	15.50	XTP15-15.50	XTK15-15.50	XTN15-15.50
-	0.6142	15.60	XTP15-15.60	XTK15-15.60	XTN15-15.60
-	0.6181	15.70	XTP15-15.70	XTK15-15.70	XTN15-15.70
-	0.6220	15.80	XTP15-15.80	XTK15-15.80	XTN15-15.80
5/8	0.6250	15.88	XTP15-15.88	XTK15-15.88	XTN15-15.88

Inserts sold in multiples of 1

A20: 68 - 83

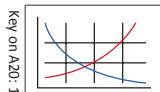

A20: 6 - 9



Sizes not shown are available upon request.  
When ordering, please follow the example below:

<b>Imperial:</b>	0.5180", Steel, 13 series = use Part No. <b>XTP13-13.16</b>
<b>Metric:</b>	13.16mm, Steel, 13 series = use Part No. <b>XTP13-13.16</b>

### GEN3SYS XT Pro Drill Insert Holders

15 Series | Diameter Range: 0.5906" - 0.6298" (15.00mm - 15.99mm)

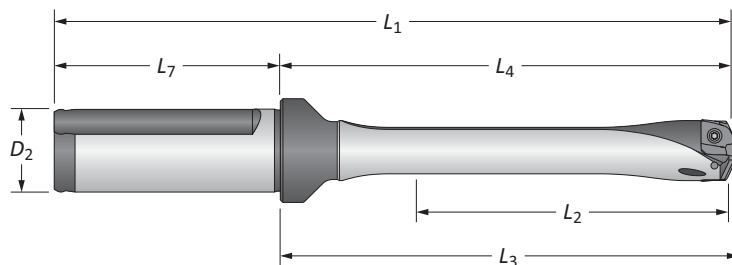

Flute	Body					Shank			Part No.
	Length	L <sub>2</sub>	L <sub>4</sub>	L <sub>3</sub>	L <sub>1</sub>	L <sub>7</sub>	D <sub>2</sub>	Flat	
i Straight 	3xD	1-57/64	2-61/64	3-3/64	4-63/64	2-1/32	3/4	YES	HXT0315S-075F
	3xD	1-57/64	2-61/64	3-3/64	4-63/64	2-1/32	3/4	NO	HXT0315S-075C
	5xD	3-9/64	4-13/64	4-5/16	6-15/64	2-1/32	3/4	YES	HXT0515S-075F
	5xD	3-9/64	4-13/64	4-5/16	6-15/64	2-1/32	3/4	NO	HXT0515S-075C
	7xD	4-13/32	5-15/32	5-37/64	7-1/2	2-1/32	3/4	YES	HXT0715S-075F
	7xD	4-13/32	5-15/32	5-37/64	7-1/2	2-1/32	3/4	NO	HXT0715S-075C
	10xD	6-19/64	7-23/64	7-29/64	9-25/64	2-1/32	3/4	YES	HXT1015S-075F
10xD	6-19/64	7-23/64	7-29/64	9-25/64	2-1/32	3/4	NO	HXT1015S-075C	
ii Straight 	3xD	48.0	75.0	77.5	125.0	50.0	20.0	YES	HXT0315S-20FM
	3xD	48.0	75.0	77.5	125.0	50.0	20.0	NO	HXT0315S-20CM
	5xD	79.8	106.8	109.5	156.8	50.0	20.0	YES	HXT0515S-20FM
	5xD	79.8	106.8	109.5	156.8	50.0	20.0	NO	HXT0515S-20CM
	7xD	111.9	138.9	141.5	188.9	50.0	20.0	YES	HXT0715S-20FM
	7xD	111.9	138.9	141.5	188.9	50.0	20.0	NO	HXT0715S-20CM
	10xD	159.9	186.9	189.5	236.9	50.0	20.0	YES	HXT1015S-20FM
	10xD	159.9	186.9	189.5	236.9	50.0	20.0	NO	HXT1015S-20CM

#### Connection Accessories

					<b>Admissible Tightening Torque*</b>
7247-IP7-1	7247N-IP7-1	8IP-7	8IP-7TL	8IP-7B	7.4 in-lbs (84 N-cm)

\*Tightening torques are calculated with a friction coefficient of  $\mu = 0.14$  and develop 90% of ultimate yield strength

**⚠ WARNING** Refer to Speed and Feed charts for recommended adjustments to speeds and feeds. Refer to page A20: 86 for deep hole drilling guidelines in this section of the catalog. Visit [www.alliedmachine.com/DeepHoleGuidelines](http://www.alliedmachine.com/DeepHoleGuidelines) for the most up-to-date information and procedures. Factory technical assistance is available for your specific applications through our Application Engineering Team.

i = Imperial (in)  
ii = Metric (mm)

Screws sold in multiples of 10



## GEN3SYS XT Drill Inserts

15 Series | Diameter Range: 0.5906" - 0.6298" (15.00mm - 15.99mm)

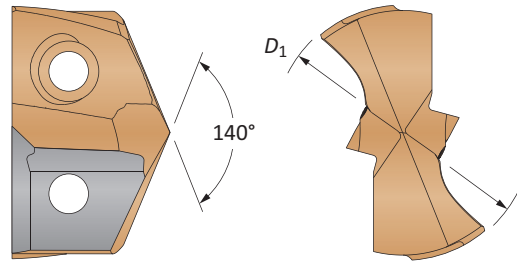
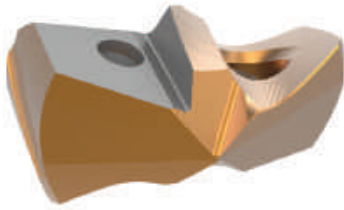

Carbide Substrate	Insert			Standard Part No.	Low Rake Part No.	Cast Iron Part No.	Stainless Part No.
	Fractional Equivalent	$D_1$ inch	$D_1$ mm				
C1 (K35)	-	0.5906	15.00	<b>7C115P-15</b>	<b>7C115P-15LR</b>	-	-
	19/32	0.5938	15.08	<b>7C115P-0019</b>	<b>7C115P-0019LR</b>	-	-
	-	0.6004	15.25	<b>7C115P-15.25</b>	<b>7C115P-15.25LR</b>	-	-
	39/64	0.6094	15.48	<b>7C115P-.609</b>	<b>7C115P-.609LR</b>	-	-
	-	0.6103	15.50	<b>7C115P-15.5</b>	<b>7C115P-15.5LR</b>	-	-
	-	0.6181	15.70	<b>7C115P-.618</b>	<b>7C115P-.618LR</b>	-	-
	5/8	0.6250	15.88	<b>7C115P-0020</b>	<b>7C115P-0020LR</b>	-	-
C2 (K20)	-	0.5906	15.00	<b>7C215P-15</b>	<b>7C215P-15LR</b>	<b>7C215P-15CI</b>	<b>7C215P-15AS</b>
	19/32	0.5938	15.08	<b>7C215P-0019</b>	<b>7C215P-0019LR</b>	<b>7C215P-0019CI</b>	<b>7C215P-0019AS</b>
	-	0.6004	15.25	<b>7C215P-15.25</b>	<b>7C215P-15.25LR</b>	<b>7C215P-15.25CI</b>	<b>7C215P-15.25AS</b>
	39/64	0.6094	15.48	<b>7C215P-.609</b>	<b>7C215P-.609LR</b>	<b>7C215P-.609CI</b>	<b>7C215P-.609AS</b>
	-	0.6103	15.50	<b>7C215P-15.5</b>	<b>7C215P-15.5LR</b>	<b>7C215P-15.5CI</b>	<b>7C215P-15.5AS</b>
	-	0.6181	15.70	<b>7C215P-.618</b>	<b>7C215P-.618LR</b>	<b>7C215P-.618CI</b>	<b>7C215P-.618AS</b>
	5/8	0.6250	15.88	<b>7C215P-0020</b>	<b>7C215P-0020LR</b>	<b>7C215P-0020CI</b>	<b>7C215P-0020AS</b>

Inserts sold in multiples of 1

A20: 68 - 83

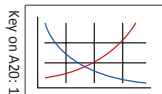

A20: 6 - 9



Key on A20: 1

Sizes not shown are available upon request.  
When ordering, please follow the example below:

<b>Imperial:</b>	0.5200", 13 series, C2 = use Part No. <b>7C213P-.5200</b>
<b>Metric:</b>	13.20mm, 13 series, C2 = use Part No. <b>7C213P-13.20</b>



**GEN3SYS Drill Insert Holders**

15 Series | Diameter Range: 0.5906" - 0.6298" (15.00mm - 15.99mm)

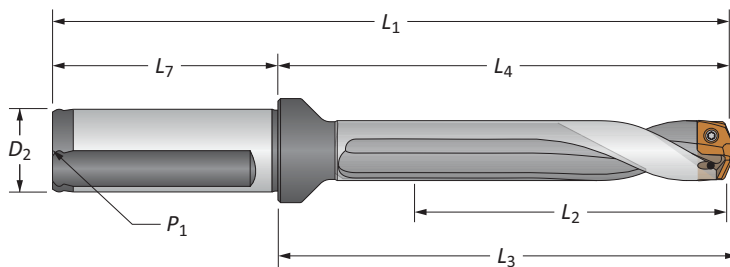

**Straight and Helical**

Flute	Length	Body				Shank				Flat	Part No.
		L <sub>2</sub>	L <sub>4</sub>	L <sub>3</sub>	L <sub>1</sub>	L <sub>7</sub>	D <sub>2</sub>	P <sub>1</sub>			
	3xD	1-57/64	2-61/64	3-3/64	4-63/64	2-1/32	3/4	1/8	YES	<b>60315S-075F</b>	
	5xD	3-9/64	4-13/64	4-5/16	6-15/64	2-1/32	3/4	1/8	YES	<b>60515S-075F</b>	
	7xD	4-13/32	5-15/32	5-37/64	7-1/2	2-1/32	3/4	1/8	YES	<b>60715S-075F</b>	
	Stub	11/16	1-3/4	1-27/32	3-25/32	2-1/32	3/4	1/8	YES	<b>60115H-075F</b>	
	3xD	1-57/64	2-61/64	3-3/64	4-63/64	2-1/32	3/4	1/8	YES	<b>60315H-075F</b>	
	3xD	1-57/64	2-61/64	3-3/64	4-63/64	2-1/32	3/4	1/8	NO	<b>60315H-075C</b>	
	5xD	3-9/64	4-13/64	4-5/16	6-15/64	2-1/32	3/4	1/8	YES	<b>60515H-075F</b>	
	5xD	3-9/64	4-13/64	4-5/16	6-15/64	2-1/32	3/4	1/8	NO	<b>60515H-075C</b>	
	7xD	4-13/32	5-15/32	5-37/64	7-1/2	2-1/32	3/4	1/8	YES	<b>60715H-075F</b>	
	7xD	4-13/32	5-15/32	5-37/64	7-1/2	2-1/32	3/4	1/8	NO	<b>60715H-075C</b>	
	Straight	3xD	48.0	75.0	77.5	125.0	50.0	20.0	1/8*	YES	<b>60315S-20FM</b>
		5xD	79.8	106.8	109.5	156.8	50.0	20.0	1/8*	YES	<b>60515S-20FM</b>
		7xD	111.9	138.9	141.5	188.9	50.0	20.0	1/8*	YES	<b>60715S-20FM</b>
	Helical	Stub	17.5	44.5	46.8	94.5	50.0	20.0	1/8*	YES	<b>60115H-20FM</b>
		3xD	48.0	75.0	77.5	125.0	50.0	20.0	1/8*	YES	<b>60315H-20FM</b>
		3xD	48.0	75.0	77.5	125.0	50.0	20.0	1/8*	NO	<b>60315H-20CM</b>
		5xD	79.8	106.8	109.5	156.8	50.0	20.0	1/8*	YES	<b>60515H-20FM</b>
		5xD	79.8	106.8	109.5	156.8	50.0	20.0	1/8*	NO	<b>60515H-20CM</b>
		7xD	111.9	138.9	141.5	188.9	50.0	20.0	1/8*	YES	<b>60715H-20FM</b>
		7xD	111.9	138.9	141.5	188.9	50.0	20.0	1/8*	NO	<b>60715H-20CM</b>

\*Thread to BSP and ISO 7-1

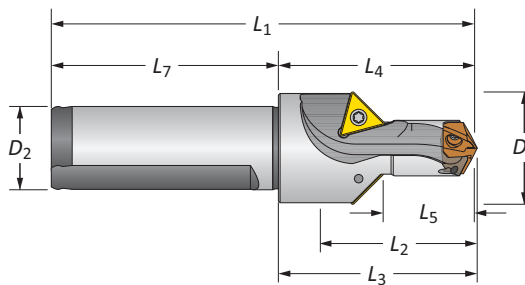

**Drill / Chamfer**

	Step		Body				Shank		Part No.	Chamfer Insert
	D <sub>5</sub>	L <sub>5</sub>	L <sub>2</sub>	L <sub>4</sub>	L <sub>3</sub>	L <sub>1</sub>	L <sub>7</sub>	D <sub>2</sub>		
	1-1/16	57/64	1-1/16	1-47/64	1-27/32	3-49/64	2-1/32	3/4	<b>60115C45-075F</b>	TCMT-110204
	27.0	22.5	26.9	44.3	46.8	94.3	50.0	20.0	<b>60115C45-20FM</b>	TCMT-110204

**Connection Accessories**

					Admissible Tightening Torque*
7247-IP7-1	7247N-IP7-1	8IP-7	8IP-7TL	8IP-7B	7.4 in-lbs (84 N-cm)

\*Tightening torques are calculated with a friction coefficient of  $\mu = 0.14$  and develop 90% of ultimate yield strength



Chamfer inserts sold separately in multiples of 10 | Screws sold in multiples of 10

= Imperial (in)  
 = Metric (mm)

## GEN3SYS XT Pro Drill Inserts

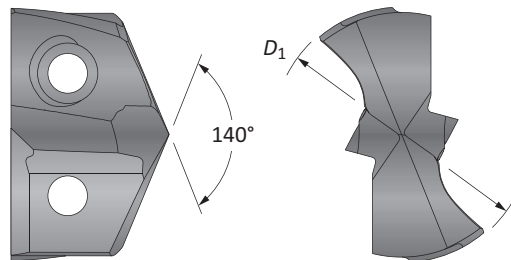
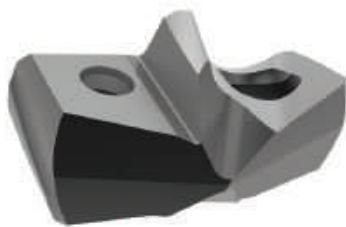
16 Series | Diameter Range: 0.6299" - 0.6692" (16.00mm - 16.99mm)



Fractional Equivalent	Insert				
	$D_1$ inch	$D_1$ mm	Part No. <b>P</b>	Part No. <b>K</b>	Part No. <b>N</b>
-	0.6299	16.00	XTP16-16.00	XTK16-16.00	XTN16-16.00
-	0.6331	16.08	XTP16-16.08	XTK16-16.08	XTN16-16.08
-	0.6378	16.20	XTP16-16.20	XTK16-16.20	XTN16-16.20
41/64	0.6406	16.27	XTP16-16.27	XTK16-16.27	XTN16-16.27
-	0.6457	16.40	XTP16-16.40	XTK16-16.40	XTN16-16.40
-	0.6496	16.50	XTP16-16.50	XTK16-16.50	XTN16-16.50
-	0.6535	16.60	XTP16-16.60	XTK16-16.60	XTN16-16.60
21/32	0.6563	16.67	XTP16-16.67	XTK16-16.67	XTN16-16.67
-	0.6614	16.80	XTP16-16.80	XTK16-16.80	XTN16-16.80
-	0.6654	16.90	XTP16-16.90	XTK16-16.90	XTN16-16.90

Inserts sold in multiples of 1

A20: 68 - 83

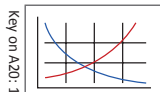

A20: 6 - 9



Sizes not shown are available upon request.



When ordering, please follow the example below:

<b>Imperial:</b>	0.5180", Steel, 13 series = use Part No. <b>XTP13-13.16</b>
<b>Metric:</b>	13.16mm, Steel, 13 series = use Part No. <b>XTP13-13.16</b>



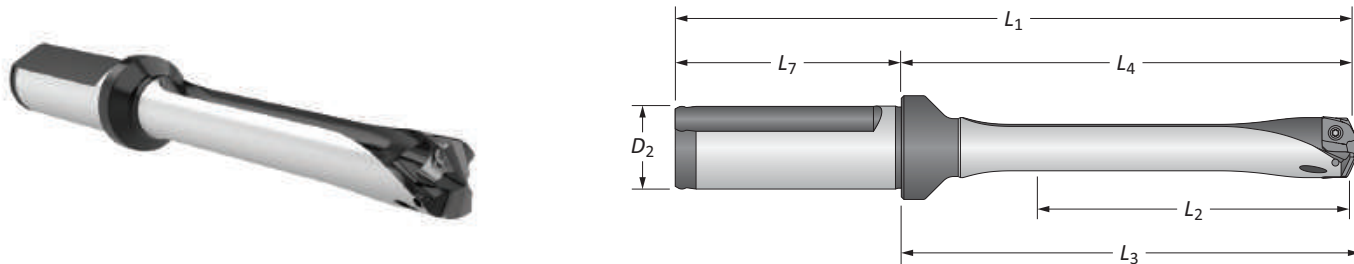

### GEN3SYS XT Pro Drill Insert Holders

16 Series | Diameter Range: 0.6299" - 0.6692" (16.00mm - 16.99mm)

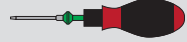

Flute	Body					Shank			Part No.
	Length	L <sub>2</sub>	L <sub>4</sub>	L <sub>3</sub>	L <sub>1</sub>	L <sub>7</sub>	D <sub>2</sub>	Flat	
i Straight 	3xD	2	3-13/64	3-5/16	5-15/64	2-1/32	3/4	YES	HXT0316S-075F
	3xD	2	3-13/64	3-5/16	5-15/64	2-1/32	3/4	NO	HXT0316S-075C
	5xD	3-11/32	4-17/32	4-21/32	6-9/16	2-1/32	3/4	YES	HXT0516S-075F
	5xD	3-11/32	4-17/32	4-21/32	6-9/16	2-1/32	3/4	NO	HXT0516S-075C
	7xD	4-11/16	5-7/8	5-63/64	7-29/32	2-1/32	3/4	YES	HXT0716S-075F
	7xD	4-11/16	5-7/8	5-63/64	7-29/32	2-1/32	3/4	NO	HXT0716S-075C
	10xD	6-11/16	7-7/8	8	9-29/32	2-1/32	3/4	YES	HXT1016S-075F
10xD	6-11/16	7-7/8	8	9-29/32	2-1/32	3/4	NO	HXT1016S-075C	
ii Straight 	3xD	50.8	81.3	84.2	131.3	50.0	20.0	YES	HXT0316S-20FM
	3xD	50.8	81.3	84.2	131.3	50.0	20.0	NO	HXT0316S-20CM
	5xD	85.0	115.1	118.2	165.1	50.0	20.0	YES	HXT0516S-20FM
	5xD	85.0	115.1	118.2	165.1	50.0	20.0	NO	HXT0516S-20CM
	7xD	119.0	149.2	152.0	199.2	50.0	20.0	YES	HXT0716S-20FM
	7xD	119.0	149.2	152.0	199.2	50.0	20.0	NO	HXT0716S-20CM
	10xD	169.9	200.0	203.2	250.0	50.0	20.0	YES	HXT1016S-20FM
	10xD	169.9	200.0	203.2	250.0	50.0	20.0	NO	HXT1016S-20CM

#### Connection Accessories

					<b>Admissible Tightening Torque*</b>
72556-IP8-1	72556N-IP8-1	8IP-8	8IP-8TL	8IP-8B	15.5 in-lbs (175 N-cm)

\*Tightening torques are calculated with a friction coefficient of  $\mu = 0.14$  and develop 90% of ultimate yield strength

**WARNING** Refer to Speed and Feed charts for recommended adjustments to speeds and feeds. Refer to page A20: 86 for deep hole drilling guidelines in this section of the catalog. Visit [www.alliedmachine.com/DeepHoleGuidelines](http://www.alliedmachine.com/DeepHoleGuidelines) for the most up-to-date information and procedures. Factory technical assistance is available for your specific applications through our Application Engineering Team.

i = Imperial (in)  
 ii = Metric (mm)

Screws sold in multiples of 10

**GEN3SYS XT Drill Inserts**

16 Series | Diameter Range: 0.6299" - 0.6692" (16.00mm - 16.99mm)

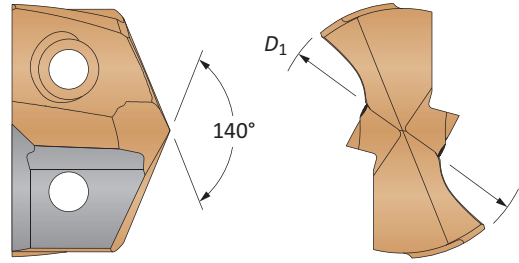
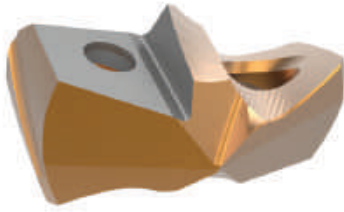

Carbide Substrate	Insert			Standard Part No.	Low Rake Part No.	Cast Iron Part No.	Stainless Part No.
	Fractional Equivalent	D <sub>1</sub> inch	D <sub>1</sub> mm				
C1 (K35)	-	0.6299	16.00	<b>7C116P-16</b>	<b>7C116P-16LR</b>	-	-
	-	0.6331	16.08	<b>7C116P-16.08</b>	<b>7C116P-16.08LR</b>	-	-
	41/64	0.6406	16.27	<b>7C116P-.640</b>	<b>7C116P-.640LR</b>	-	-
	-	0.6496	16.50	<b>7C116P-16.5</b>	<b>7C116P-16.5LR</b>	-	-
	21/32	0.6563	16.67	<b>7C116P-0021</b>	<b>7C116P-0021LR</b>	-	-
C2 (K20)	-	0.6299	16.00	<b>7C216P-16</b>	<b>7C216P-16LR</b>	<b>7C216P-16CI</b>	<b>7C216P-16AS</b>
	-	0.6331	16.08	<b>7C216P-16.08</b>	<b>7C216P-16.08LR</b>	<b>7C216P-16.08CI</b>	<b>7C216P-16.08AS</b>
	41/64	0.6406	16.27	<b>7C216P-.640</b>	<b>7C216P-.640LR</b>	<b>7C216P-.640CI</b>	<b>7C216P-.640AS</b>
	-	0.6496	16.50	<b>7C216P-16.5</b>	<b>7C216P-16.5LR</b>	<b>7C216P-16.5CI</b>	<b>7C216P-16.5AS</b>
	21/32	0.6563	16.67	<b>7C216P-0021</b>	<b>7C216P-0021LR</b>	<b>7C216P-0021CI</b>	<b>7C216P-0021AS</b>

Inserts sold in multiples of 1

A  
DRILLING

B  
BORING

C  
REAMING

D  
BURNISHING

E  
THREADING

X  
SPECIALS

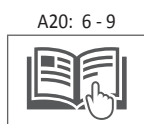
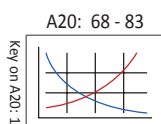

Sizes not shown are available upon request.	
When ordering, please follow the example below:	
<b>Imperial:</b>	0.5200", 13 series, C2 = use Part No. <b>7C213P-.5200</b>
<b>Metric:</b>	13.20mm, 13 series, C2 = use Part No. <b>7C213P-13.20</b>

### GEN3SYS Drill Insert Holders

16 Series | Diameter Range: 0.6299" - 0.6692" (16.00mm - 16.99mm)

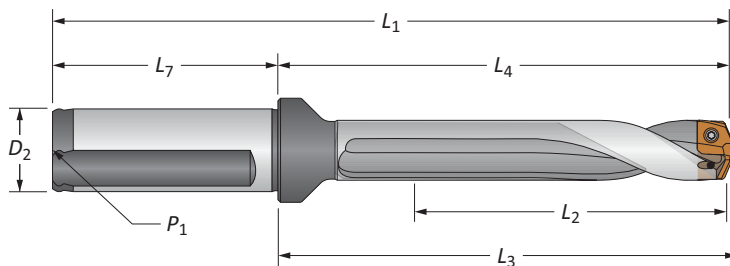

#### Straight and Helical

Flute	Length	Body				Shank				Flat	Part No.
		L <sub>2</sub>	L <sub>4</sub>	L <sub>3</sub>	L <sub>1</sub>	L <sub>7</sub>	D <sub>2</sub>	P <sub>1</sub>			
	3xD	2	3-13/64	3-5/16	5-15/64	2-1/32	3/4	1/8	YES	<b>60316S-075F</b>	
	5xD	3-11/32	4-17/32	4-21/32	6-9/16	2-1/32	3/4	1/8	YES	<b>60516S-075F</b>	
	7xD	4-11/16	5-7/8	5-63/64	7-29/32	2-1/32	3/4	1/8	YES	<b>60716S-075F</b>	
	Stub	13/16	2	2-7/64	4-1/32	2-1/32	3/4	1/8	YES	<b>60116H-075F</b>	
	3xD	2	3-13/64	3-5/16	5-15/64	2-1/32	3/4	1/8	YES	<b>60316H-075F</b>	
	3xD	2	3-13/64	3-5/16	5-15/64	2-1/32	3/4	1/8	NO	<b>60316H-075C</b>	
	5xD	3-11/32	4-17/32	4-21/32	6-9/16	2-1/32	3/4	1/8	YES	<b>60516H-075F</b>	
	5xD	3-11/32	4-17/32	4-21/32	6-9/16	2-1/32	3/4	1/8	NO	<b>60516H-075C</b>	
	7xD	4-11/16	5-7/8	5-63/64	7-29/32	2-1/32	3/4	1/8	YES	<b>60716H-075F</b>	
	7xD	4-11/16	5-7/8	5-63/64	7-29/32	2-1/32	3/4	1/8	NO	<b>60716H-075C</b>	
		3xD	50.8	81.3	84.2	131.3	50.0	20.0	1/8*	YES	<b>60316S-20FM</b>
5xD		85.0	115.1	118.2	165.1	50.0	20.0	1/8*	YES	<b>60516S-20FM</b>	
7xD		119.0	149.2	152.0	199.2	50.0	20.0	1/8*	YES	<b>60716S-20FM</b>	
Stub		21.0	50.8	53.7	100.8	50.0	20.0	1/8*	YES	<b>60116H-20FM</b>	
3xD		50.8	81.3	84.2	131.3	50.0	20.0	1/8*	YES	<b>60316H-20FM</b>	
3xD		50.8	81.3	84.2	131.3	50.0	20.0	1/8*	NO	<b>60316H-20CM</b>	
5xD		85.0	115.1	118.2	165.1	50.0	20.0	1/8*	YES	<b>60516H-20FM</b>	
5xD		85.0	115.1	118.2	165.1	50.0	20.0	1/8*	NO	<b>60516H-20CM</b>	
7xD		119.0	149.2	152.0	199.2	50.0	20.0	1/8*	YES	<b>60716H-20FM</b>	
7xD		119.0	149.2	152.0	199.2	50.0	20.0	1/8*	NO	<b>60716H-20CM</b>	

\*Thread to BSP and ISO 7-1

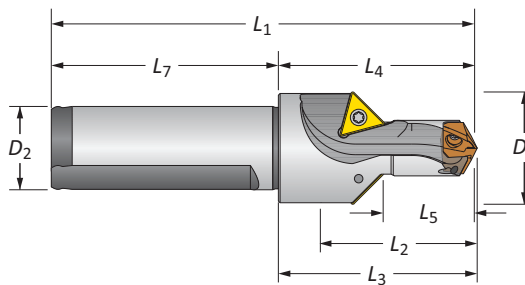

#### Drill / Chamfer

	Step		Body				Shank		Part No.	Chamfer Insert
	D <sub>5</sub>	L <sub>5</sub>	L <sub>2</sub>	L <sub>4</sub>	L <sub>3</sub>	L <sub>1</sub>	L <sub>7</sub>	D <sub>2</sub>		
<b>i</b>	1-1/16	61/64	1-19/64	2	2-7/64	4-1/32	2-1/32	3/4	<b>60116C45-075F</b>	TCMT-110204
<b>m</b>	27.0	24.0	33.1	50.8	53.7	100.8	50.0	20.0	<b>60116C45-20FM</b>	TCMT-110204

#### Connection Accessories

					Admissible Tightening Torque*
72556-IP8-1	72556N-IP8-1	8IP-8	8IP-8TL	8IP-8B	15.5 in-lbs (175 N-cm)

\*Tightening torques are calculated with a friction coefficient of  $\mu = 0.14$  and develop 90% of ultimate yield strength



Chamfer inserts sold separately in multiples of 10 | Screws sold in multiples of 10

**i** = Imperial (in)  
**m** = Metric (mm)

## GEN3SYS XT Pro Drill Inserts

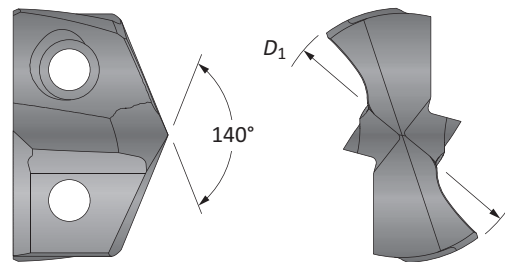
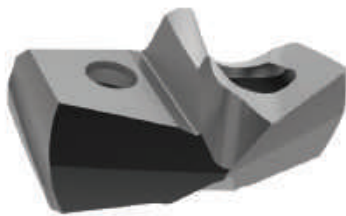
17 Series | Diameter Range: 0.6693" - 0.7086" (17.00mm - 17.99mm)



Fractional Equivalent	Insert				
	$D_1$ inch	$D_1$ mm	Part No. <b>P</b>	Part No. <b>K</b>	Part No. <b>N</b>
-	0.6693	17.00	XTP17-17.00	XTK17-17.00	XTN17-17.00
43/64	0.6719	17.07	XTP17-17.07	XTK17-17.07	XTN17-17.07
-	0.6732	17.10	XTP17-17.10	XTK17-17.10	XTN17-17.10
-	0.6772	17.20	XTP17-17.20	XTK17-17.20	XTN17-17.20
-	0.6811	17.30	XTP17-17.30	XTK17-17.30	XTN17-17.30
-	0.6850	17.40	XTP17-17.40	XTK17-17.40	XTN17-17.40
11/16	0.6875	17.46	XTP17-17.46	XTK17-17.46	XTN17-17.46
-	0.6890	17.50	XTP17-17.50	XTK17-17.50	XTN17-17.50
-	0.6929	17.60	XTP17-17.60	XTK17-17.60	XTN17-17.60
-	0.6969	17.70	XTP17-17.70	XTK17-17.70	XTN17-17.70
-	0.7008	17.80	XTP17-17.80	XTK17-17.80	XTN17-17.80
45/64	0.7031	17.86	XTP17-17.86	XTK17-17.86	XTN17-17.86
-	0.7047	17.90	XTP17-17.90	XTK17-17.90	XTN17-17.90

Inserts sold in multiples of 1

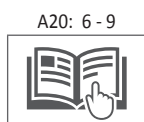
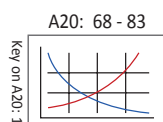



Sizes not shown are available upon request.	
When ordering, please follow the example below:	
<b>Imperial:</b>	0.5180", Steel, 13 series = use Part No. <b>XTP13-13.16</b>
<b>Metric:</b>	13.16mm, Steel, 13 series = use Part No. <b>XTP13-13.16</b>

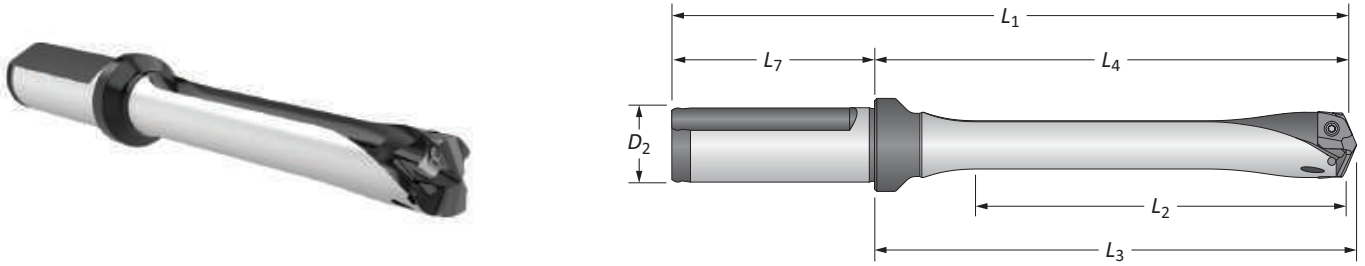

## GEN3SYS XT Pro Drill Insert Holders

17 Series | Diameter Range: 0.6693" - 0.7086" (17.00mm - 17.99mm)



Flute	Body					Shank			Flat	Part No.
	Length	L <sub>2</sub>	L <sub>4</sub>	L <sub>3</sub>	L <sub>1</sub>	L <sub>7</sub>	D <sub>2</sub>			
i Straight 	3xD	2-1/8	3-19/64	3-27/64	5-21/64	2-1/32	3/4	YES	HXT0317S-075F	
	3xD	2-1/8	3-19/64	3-27/64	5-21/64	2-1/32	3/4	NO	HXT0317S-075C	
	5xD	3-35/64	4-23/32	4-27/32	6-3/4	2-1/32	3/4	YES	HXT0517S-075F	
	5xD	3-35/64	4-23/32	4-27/32	6-3/4	2-1/32	3/4	NO	HXT0517S-075C	
	7xD	4-61/64	6-9/64	6-1/4	8-11/64	2-1/32	3/4	YES	HXT0717S-075F	
	7xD	4-61/64	6-9/64	6-1/4	8-11/64	2-1/32	3/4	NO	HXT0717S-075C	
	10xD	7-5/64	8-17/64	8-3/8	10-19/64	2-1/32	3/4	YES	HXT1017S-075F	
10xD	7-5/64	8-17/64	8-3/8	10-19/64	2-1/32	3/4	NO	HXT1017S-075C		
ii Straight 	3xD	54.0	83.8	86.9	133.8	50.0	20.0	YES	HXT0317S-20FM	
	3xD	54.0	83.8	86.9	133.8	50.0	20.0	NO	HXT0317S-20CM	
	5xD	90.0	119.8	122.9	169.8	50.0	20.0	YES	HXT0517S-20FM	
	5xD	90.0	119.8	122.9	169.8	50.0	20.0	NO	HXT0517S-20CM	
	7xD	125.8	156.0	158.9	206.0	50.0	20.0	YES	HXT0717S-20FM	
	7xD	125.8	156.0	158.9	206.0	50.0	20.0	NO	HXT0717S-20CM	
	10xD	179.8	209.9	212.8	259.9	50.0	20.0	YES	HXT1017S-20FM	
	10xD	179.8	209.9	212.8	259.9	50.0	20.0	NO	HXT1017S-20CM	

### Connection Accessories

Insert Screws	Nylon Locking Screws	Insert Driver	Preset Torque Hand Driver	Replacement Tips	Admissible Tightening Torque*
72567-IP8-1	72567N-IP8-1	8IP-8	8IP-8TL	8IP-8B	15.5 in-lbs (175 N-cm)

\*Tightening torques are calculated with a friction coefficient of  $\mu = 0.14$  and develop 90% of ultimate yield strength

**⚠ WARNING** Refer to Speed and Feed charts for recommended adjustments to speeds and feeds. Refer to page A20: 86 for deep hole drilling guidelines in this section of the catalog. Visit [www.alliedmachine.com/DeepHoleGuidelines](http://www.alliedmachine.com/DeepHoleGuidelines) for the most up-to-date information and procedures. Factory technical assistance is available for your specific applications through our Application Engineering Team.

i = Imperial (in)  
 ii = Metric (mm)

Screws sold in multiples of 10





A DRILLING  
 B BORING  
 C REAMING  
 D BURNISHING  
 E THREADING  
 X SPECIALS

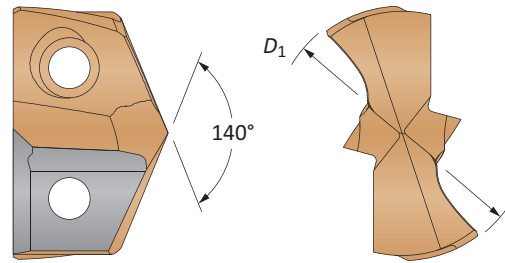
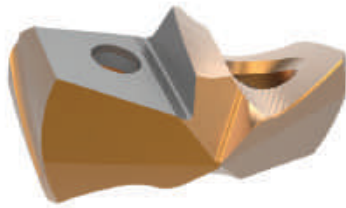

## GEN3SYS XT Drill Inserts

17 Series | Diameter Range: 0.6693" - 0.7086" (17.00mm - 17.99mm)



Carbide Substrate	Insert						
	Fractional Equivalent	$D_1$ inch					$D_1$ mm
C1 (K35)		0.6693	17.00	<b>7C117P-17</b>	<b>7C117P-17LR</b>	-	-
	43/64	0.6719	17.07	<b>7C117P-.671</b>	<b>7C117P-.671LR</b>	-	-
		0.6732	17.10	<b>7C117P-17.1</b>	<b>7C117P-17.1LR</b>	-	-
		0.6772	17.20	<b>7C117P-17.2</b>	<b>7C117P-17.2LR</b>	-	-
	11/16	0.6875	17.46	<b>7C117P-0022</b>	<b>7C117P-0022LR</b>	-	-
		0.6890	17.50	<b>7C117P-17.5</b>	<b>7C117P-17.5LR</b>	-	-
	45/64	0.7031	17.86	<b>7C117P-.703</b>	<b>7C117P-.703LR</b>	-	-
C2 (K20)		0.6693	17.00	<b>7C217P-17</b>	<b>7C217P-17LR</b>	<b>7C217P-17CI</b>	<b>7C217P-17AS</b>
	43/64	0.6719	17.07	<b>7C217P-.671</b>	<b>7C217P-.671LR</b>	<b>7C217P-.671CI</b>	<b>7C217P-.671AS</b>
		0.6732	17.10	<b>7C217P-17.1</b>	<b>7C217P-17.1LR</b>	<b>7C217P-17.1CI</b>	<b>7C217P-17.1AS</b>
		0.6772	17.20	<b>7C217P-17.2</b>	<b>7C217P-17.2LR</b>	<b>7C217P-17.2CI</b>	<b>7C217P-17.2AS</b>
	11/16	0.6875	17.46	<b>7C217P-0022</b>	<b>7C217P-0022LR</b>	<b>7C217P-0022CI</b>	<b>7C217P-0022AS</b>
		0.6890	17.50	<b>7C217P-17.5</b>	<b>7C217P-17.5LR</b>	<b>7C217P-17.5CI</b>	<b>7C217P-17.5AS</b>
	45/64	0.7031	17.86	<b>7C217P-.703</b>	<b>7C217P-.703LR</b>	<b>7C217P-.703CI</b>	<b>7C217P-.703AS</b>

Inserts sold in multiples of 1

A20: 68 - 83

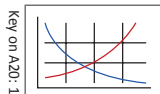

A20: 6 - 9



Sizes not shown are available upon request.  
When ordering, please follow the example below:

<b>Imperial:</b>	0.5200", 13 series, C2 = use Part No. <b>7C213P-.5200</b>
<b>Metric:</b>	13.20mm, 13 series, C2 = use Part No. <b>7C213P-13.20</b>



**GEN3SYS Drill Insert Holders**

17 Series | Diameter Range: 0.6693" - 0.7086" (17.00mm - 17.99mm)

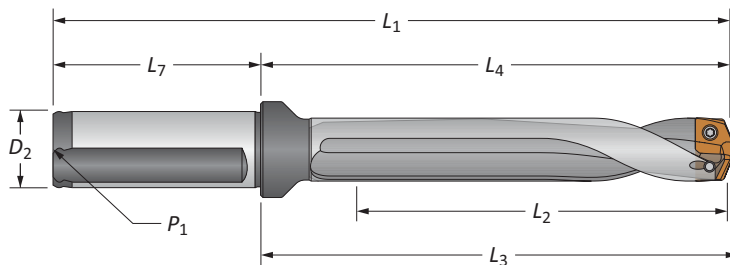

**Straight and Helical**

Flute	Length	Body				Shank				Flat	Part No.
		L <sub>2</sub>	L <sub>4</sub>	L <sub>3</sub>	L <sub>1</sub>	L <sub>7</sub>	D <sub>2</sub>	P <sub>1</sub>			
Straight	3xD	2-1/8	3-19/64	3-27/64	5-21/64	2-1/32	3/4	1/8	YES	<b>60317S-075F</b>	
	5xD	3-35/64	4-23/32	4-27/32	6-3/4	2-1/32	3/4	1/8	YES	<b>60517S-075F</b>	
	7xD	4-61/64	6-9/64	6-1/4	8-11/64	2-1/32	3/4	1/8	YES	<b>60717S-075F</b>	
Helical	Stub	1-63/64	1-63/64	2-7/64	4-1/64	2-1/32	3/4	1/8	YES	<b>60117H-075F</b>	
	3xD	2-1/8	3-19/64	3-27/64	5-21/64	2-1/32	3/4	1/8	YES	<b>60317H-075F</b>	
	3xD	2-1/8	3-19/64	3-27/64	5-21/64	2-1/32	3/4	1/8	NO	<b>60317H-075C</b>	
	5xD	3-35/64	4-23/32	4-27/32	6-3/4	2-1/32	3/4	1/8	YES	<b>60517H-075F</b>	
	5xD	3-35/64	4-23/32	4-27/32	6-3/4	2-1/32	3/4	1/8	NO	<b>60517H-075C</b>	
	7xD	4-61/64	6-9/64	6-1/4	8-11/64	2-1/32	3/4	1/8	YES	<b>60717H-075F</b>	
	7xD	4-61/64	6-9/64	6-1/4	8-11/64	2-1/32	3/4	1/8	NO	<b>60717H-075C</b>	
	7xD	4-61/64	6-9/64	6-1/4	8-11/64	2-1/32	3/4	1/8	NO	<b>60717H-075C</b>	
Straight	3xD	54.0	83.8	86.9	133.8	50.0	20.0	1/8*	YES	<b>60317S-20FM</b>	
	5xD	90.0	119.8	122.9	169.8	50.0	20.0	1/8*	YES	<b>60517S-20FM</b>	
	7xD	125.8	156.0	158.9	206.0	50.0	20.0	1/8*	YES	<b>60717S-20FM</b>	
	Stub	20.6	50.5	53.5	100.5	50.0	20.0	1/8*	YES	<b>60117H-20FM</b>	
	3xD	54.0	83.8	86.9	133.8	50.0	20.0	1/8*	YES	<b>60317H-20FM</b>	
	3xD	54.0	83.8	86.9	133.8	50.0	20.0	1/8*	NO	<b>60317H-20CM</b>	
	5xD	90.0	119.8	122.9	169.8	50.0	20.0	1/8*	YES	<b>60517H-20FM</b>	
	5xD	90.0	119.8	122.9	169.8	50.0	20.0	1/8*	NO	<b>60517H-20CM</b>	
	7xD	125.8	156.0	158.9	206.0	50.0	20.0	1/8*	YES	<b>60717H-20FM</b>	
	7xD	125.8	156.0	158.9	206.0	50.0	20.0	1/8*	NO	<b>60717H-20CM</b>	

\*Thread to BSP and ISO 7-1

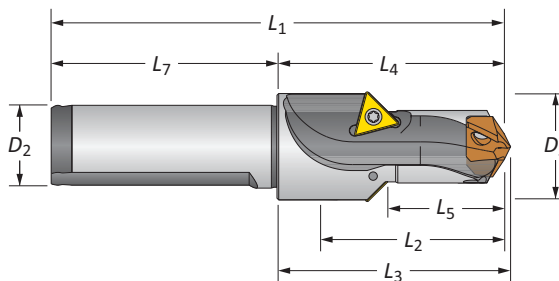

**Drill / Chamfer**

Step	Body				Shank			Part No.	Chamfer Insert
	D <sub>5</sub>	L <sub>5</sub>	L <sub>2</sub>	L <sub>4</sub>	L <sub>3</sub>	L <sub>1</sub>	L <sub>7</sub>		
<b>i</b> 1	1	1-5/16	1-63/64	2-7/64	4-1/64	2-1/32	3/4	<b>60117C45-075F</b>	TCMT-110204
<b>m</b> 25.4	25.5	33.3	50.5	53.4	100.5	50.0	20.0	<b>60117C45-20FM</b>	TCMT-110204

**Connection Accessories**

Insert Screws	Nylon Locking Screws	Insert Driver	Preset Torque Hand Driver	Replacement Tips	Admissible Tightening Torque*
72567-IP8-1	72567N-IP8-1	8IP-8	8IP-8TL	8IP-8B	15.5 in-lbs (175 N-cm)

\*Tightening torques are calculated with a friction coefficient of  $\mu = 0.14$  and develop 90% of ultimate yield strength

Chamfer inserts sold separately in multiples of 10 | Screws sold in multiples of 10



**i** = Imperial (in)  
**m** = Metric (mm)

A  
DRILLING  
B  
BORING  
C  
REAMING  
D  
BURNISHING  
E  
THREADING  
X  
SPECIALS

## GEN3SYS XT Pro Drill Inserts

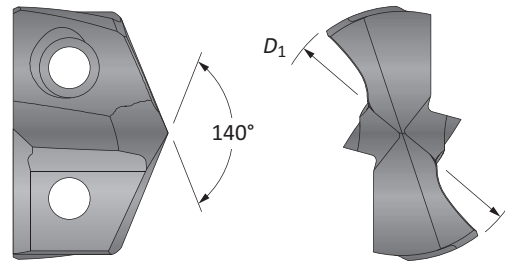
18 Series | Diameter Range: 0.7087" - 0.7873" (18.00mm - 19.99mm)



Fractional Equivalent	Insert				
	$D_1$ inch	$D_1$ mm	Part No. <b>P</b>	Part No. <b>K</b>	Part No. <b>N</b>
-	0.7087	18.00	XTP18-18.00	XTK18-18.00	XTN18-18.00
-	0.7126	18.10	XTP18-18.10	XTK18-18.10	XTN18-18.10
-	0.7165	18.20	XTP18-18.20	XTK18-18.20	XTN18-18.20
23/32	0.7188	18.26	XTP18-18.26	XTK18-18.26	XTN18-18.26
-	0.7205	18.30	XTP18-18.30	XTK18-18.30	XTN18-18.30
-	0.7244	18.40	XTP18-18.40	XTK18-18.40	XTN18-18.40
-	0.7283	18.50	XTP18-18.50	XTK18-18.50	XTN18-18.50
-	0.7323	18.60	XTP18-18.60	XTK18-18.60	XTN18-18.60
47/64	0.7344	18.65	XTP18-18.65	XTK18-18.65	XTN18-18.65
-	0.7362	18.70	XTP18-18.70	XTK18-18.70	XTN18-18.70
-	0.7402	18.80	XTP18-18.80	XTK18-18.80	XTN18-18.80
-	0.7441	18.90	XTP18-18.90	XTK18-18.90	XTN18-18.90
-	0.7480	19.00	XTP18-19.00	XTK18-19.00	XTN18-19.00
3/4	0.7500	19.05	XTP18-19.05	XTK18-19.05	XTN18-19.05
-	0.7520	19.10	XTP18-19.10	XTK18-19.10	XTN18-19.10
-	0.7559	19.20	XTP18-19.20	XTK18-19.20	XTN18-19.20
-	0.7580	19.25	XTP18-19.25	XTK18-19.25	XTN18-19.25
-	0.7598	19.30	XTP18-19.30	XTK18-19.30	XTN18-19.30
-	0.7638	19.40	XTP18-19.40	XTK18-19.40	XTN18-19.40
49/64	0.7656	19.45	XTP18-19.45	XTK18-19.45	XTN18-19.45
-	0.7677	19.50	XTP18-19.50	XTK18-19.50	XTN18-19.50
-	0.7717	19.60	XTP18-19.60	XTK18-19.60	XTN18-19.60
-	0.7756	19.70	XTP18-19.70	XTK18-19.70	XTN18-19.70
-	0.7795	19.80	XTP18-19.80	XTK18-19.80	XTN18-19.80
25/32	0.7813	19.84	XTP18-19.84	XTK18-19.84	XTN18-19.84
-	0.7835	19.90	XTP18-19.90	XTK18-19.90	XTN18-19.90

Inserts sold in multiples of 1

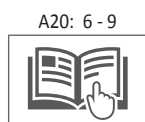
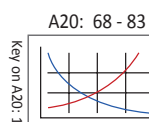

Sizes not shown are available upon request.	
When ordering, please follow the example below:	
<b>Imperial:</b>	0.5180", Steel, 13 series = use Part No. <b>XTP13-13.16</b>
<b>Metric:</b>	13.16mm, Steel, 13 series = use Part No. <b>XTP13-13.16</b>

**GEN3SYS XT Pro Drill Insert Holders**

18 Series | Diameter Range: 0.7087" - 0.7873" (18.00mm - 19.99mm)

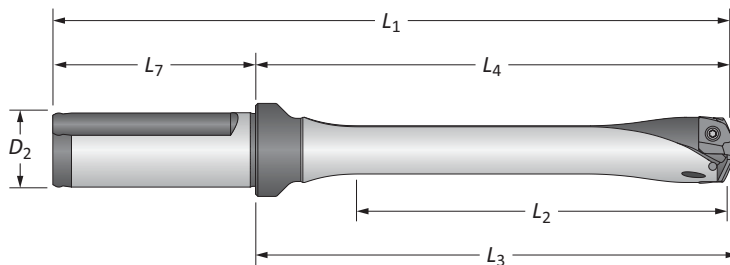

Flute	Body					Shank			Part No.
	Length	L <sub>2</sub>	L <sub>4</sub>	L <sub>3</sub>	L <sub>1</sub>	L <sub>7</sub>	D <sub>2</sub>	Flat	
i Straight 	3xD	2-23/64	3-45/64	3-13/16	5-63/64	2-9/32	1	YES	HXT0318S-100F
	3xD	2-23/64	3-45/64	3-13/16	5-63/64	2-9/32	1	NO	HXT0318S-100C
	5xD	3-15/16	5-17/64	5-25/64	7-35/64	2-9/32	1	YES	HXT0518S-100F
	5xD	3-15/16	5-17/64	5-25/64	7-35/64	2-9/32	1	NO	HXT0518S-100C
	7xD	5-33/64	6-27/32	6-61/64	9-1/8	2-9/32	1	YES	HXT0718S-100F
	7xD	5-33/64	6-27/32	6-61/64	9-1/8	2-9/32	1	NO	HXT0718S-100C
	10xD	7-7/8	9-7/32	9-5/16	11-31/64	2-9/32	1	YES	HXT1018S-100F
10xD	7-7/8	9-7/32	9-5/16	11-31/64	2-9/32	1	NO	HXT1018S-100C	
ii Straight 	3xD	60.0	94.0	96.8	150.0	56.0	25.0	YES	HXT0318S-25FM
	3xD	60.0	94.0	96.8	150.0	56.0	25.0	NO	HXT0318S-25CM
	5xD	100.0	133.7	136.8	189.7	56.0	25.0	YES	HXT0518S-25FM
	5xD	100.0	133.7	136.8	189.7	56.0	25.0	NO	HXT0518S-25CM
	7xD	140.0	173.4	176.8	229.4	56.0	25.0	YES	HXT0718S-25FM
	7xD	140.0	173.4	176.8	229.4	56.0	25.0	NO	HXT0718S-25CM
	10xD	199.9	234.1	236.7	290.1	56.0	25.0	YES	HXT1018S-25FM
	10xD	199.9	234.1	236.7	290.1	56.0	25.0	NO	HXT1018S-25CM

**Connection Accessories**

					<b>Admissible Tightening Torque*</b>
7375-IP9-1	7375N-IP9-1	8IP-9	8IP-9TL	8IP-9B	27.0 in-lbs (305 N-cm)

\*Tightening torques are calculated with a friction coefficient of  $\mu = 0.14$  and develop 90% of ultimate yield strength

**⚠ WARNING** Refer to Speed and Feed charts for recommended adjustments to speeds and feeds. Refer to page A20: 86 for deep hole drilling guidelines in this section of the catalog. Visit [www.alliedmachine.com/DeepHoleGuidelines](http://www.alliedmachine.com/DeepHoleGuidelines) for the most up-to-date information and procedures. Factory technical assistance is available for your specific applications through our Application Engineering Team.

i = Imperial (in)  
ii = Metric (mm)

Screws sold in multiples of 10

A DRILLING  
B BORING  
C REAMING  
D BURNISHING  
E THREADING  
X SPECIALS



## GEN3SYS XT Drill Inserts

18 Series | Diameter Range: 0.7087" - 0.7873" (18.00mm - 19.99mm)

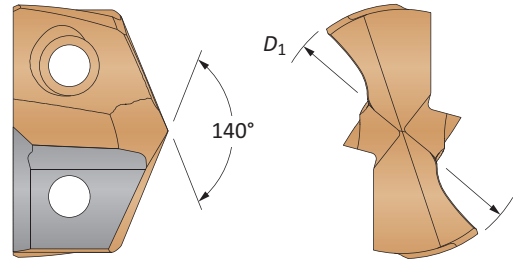
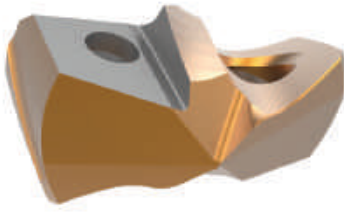

Carbide Substrate	Insert			Standard Part No.	Low Rate Part No.	Cast Iron Part No.	Stainless Part No.
	Fractional Equivalent	$D_1$ inch	$D_1$ mm				
C1 (K35)	-	0.7087	18.00	7C118P-18	7C118P-18LR	-	-
	23/32	0.7188	18.26	7C118P-0023	7C118P-0023LR	-	-
	-	0.7283	18.50	7C118P-18.5	7C118P-18.5LR	-	-
	47/64	0.7344	18.65	7C118P-.734	7C118P-.734LR	-	-
	-	0.7480	19.00	7C118P-19	7C118P-19LR	-	-
	3/4	0.7500	19.05	7C118P-0024	7C118P-0024LR	-	-
	-	0.7580	19.25	7C118P-.758	7C118P-.758LR	-	-
	49/64	0.7656	19.45	7C118P-.765	7C118P-.765LR	-	-
	-	0.7677	19.50	7C118P-19.5	7C118P-19.5LR	-	-
	-	0.7795	19.80	7C118P-19.8	7C118P-19.8LR	-	-
-	0.7813	19.85	7C118P-0025	7C118P-0025LR	-	-	
C2 (K20)	-	0.7087	18.00	7C218P-18	7C218P-18LR	7C218P-18CI	7C218P-18AS
	23/32	0.7188	18.26	7C218P-0023	7C218P-0023LR	7C218P-0023CI	7C218P-0023AS
	-	0.7283	18.50	7C218P-18.5	7C218P-18.5LR	7C218P-18.5CI	7C218P-18.5AS
	47/64	0.7344	18.65	7C218P-.734	7C218P-.734LR	7C218P-.734CI	7C218P-.734AS
	-	0.7480	19.00	7C218P-19	7C218P-19LR	7C218P-19CI	7C218P-19AS
	3/4	0.7500	19.05	7C218P-0024	7C218P-0024LR	7C218P-0024CI	7C218P-0024AS
	-	0.7580	19.25	7C218P-.758	7C218P-.758LR	7C218P-.758CI	7C218P-.758AS
	49/64	0.7656	19.45	7C218P-.765	7C218P-.765LR	7C218P-.765CI	7C218P-.765AS
	-	0.7677	19.50	7C218P-19.5	7C218P-19.5LR	7C218P-19.5CI	7C218P-19.5AS
	-	0.7795	19.80	7C218P-19.8	7C218P-19.8LR	7C218P-19.8CI	7C218P-19.8AS
-	0.7813	19.85	7C218P-0025	7C218P-0025LR	7C218P-0025CI	7C218P-0025AS	

Inserts sold in multiples of 1

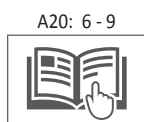
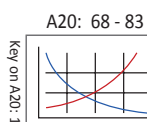

Sizes not shown are available upon request.  
When ordering, please follow the example below:

<b>Imperial:</b>	0.5200", 13 series, C2 = use Part No. <b>7C213P-.5200</b>
<b>Metric:</b>	13.20mm, 13 series, C2 = use Part No. <b>7C213P-13.20</b>

**GEN3SYS Drill Insert Holders**

18 Series | Diameter Range: 0.7087" - 0.7873" (18.00mm - 19.99mm)

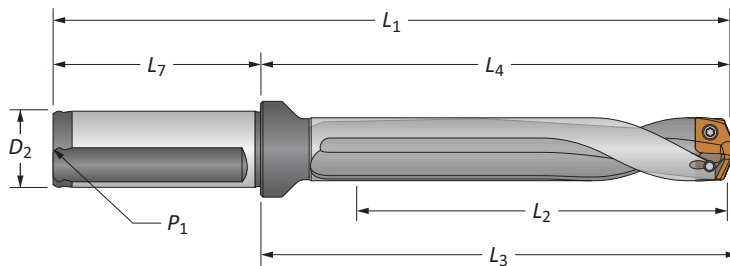

**Straight and Helical**

Flute	Length	Body					Shank				Part No.
		L <sub>2</sub>	L <sub>4</sub>	L <sub>3</sub>	L <sub>1</sub>	L <sub>7</sub>	D <sub>2</sub>	P <sub>1</sub>	Flat		
Straight	3xD	2-23/64	3-45/64	3-13/16	5-63/64	2-9/32	1	1/8	YES	<b>60318S-100F</b>	
	5xD	3-15/16	5-17/64	5-25/64	7-35/64	2-9/32	1	1/8	YES	<b>60518S-100F</b>	
	7xD	5-33/64	6-27/32	6-61/64	9-1/8	2-9/32	1	1/8	YES	<b>60718S-100F</b>	
Helical	Stub	7/8	2-13/64	2-5/16	4-31/64	2-9/32	1	1/8	YES	<b>60118H-100F</b>	
	3xD	2-23/64	3-45/64	3-13/16	5-63/64	2-9/32	1	1/8	YES	<b>60318H-100F</b>	
	3xD	2-23/64	3-45/64	3-13/16	5-63/64	2-9/32	1	1/8	NO	<b>60318H-100C</b>	
	5xD	3-15/16	5-17/64	5-25/64	7-35/64	2-9/32	1	1/8	YES	<b>60518H-100F</b>	
	5xD	3-15/16	5-17/64	5-25/64	7-35/64	2-9/32	1	1/8	NO	<b>60518H-100C</b>	
	7xD	5-33/64	6-27/32	6-61/64	9-1/8	2-9/32	1	1/8	YES	<b>60718H-100F</b>	
	7xD	5-33/64	6-27/32	6-61/64	9-1/8	2-9/32	1	1/8	NO	<b>60718H-100C</b>	
Metric	Straight	3xD	60.0	94.0	96.8	150.0	56.0	25.0	1/8*	YES	<b>60318S-25FM</b>
		5xD	100.0	133.7	136.8	189.7	56.0	25.0	1/8*	YES	<b>60518S-25FM</b>
		7xD	140.0	173.4	176.8	229.4	56.0	25.0	1/8*	YES	<b>60718S-25FM</b>
	Helical	Stub	22.0	56.0	58.8	112.0	56.0	25.0	1/8*	YES	<b>60118H-25FM</b>
		3xD	60.0	94.0	96.8	150.0	56.0	25.0	1/8*	YES	<b>60318H-25FM</b>
		3xD	60.0	94.0	96.8	150.0	56.0	25.0	1/8*	NO	<b>60318H-25CM</b>
		5xD	100.0	133.7	136.8	189.7	56.0	25.0	1/8*	YES	<b>60518H-25FM</b>
		5xD	100.0	133.7	136.8	189.7	56.0	25.0	1/8*	NO	<b>60518H-25CM</b>
		7xD	140.0	173.4	176.8	229.4	56.0	25.0	1/8*	YES	<b>60718H-25FM</b>
		7xD	140.0	173.4	176.8	229.4	56.0	25.0	1/8*	NO	<b>60718H-25CM</b>

\*Thread to BSP and ISO 7-1

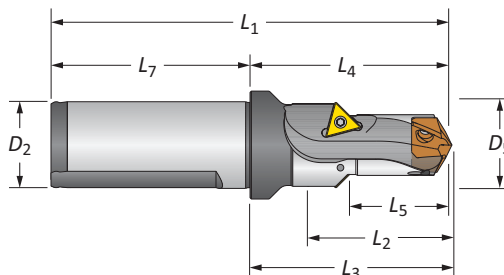

**Drill / Chamfer**

Step	Body					Shank			Part No.	Chamfer Insert
	D <sub>5</sub>	L <sub>5</sub>	L <sub>2</sub>	L <sub>4</sub>	L <sub>3</sub>	L <sub>1</sub>	L <sub>7</sub>	D <sub>2</sub>		
63/64	1-1/16	1-25/64	2-13/64	2-5/16	4-31/64	2-9/32	1	<b>60118C45-100F</b>	TCMT-110204	
25.1	27	35.2	56.0	58.8	112.0	56.0	25.0	<b>60118C45-25FM</b>	TCMT-110204	

**Connection Accessories**

Insert Screws	Nylon Locking Screws	Insert Driver	Preset Torque Hand Driver	Replacement Tips	Admissible Tightening Torque*
7375-IP9-1	7375N-IP9-1	8IP-9	8IP-9TL	8IP-9B	27.0 in-lbs (305 N-cm)

\*Tightening torques are calculated with a friction coefficient of  $\mu = 0.14$  and develop 90% of ultimate yield strength

Chamfer inserts sold separately in multiples of 10 | Screws sold in multiples of 10

= Imperial (in)  
 = Metric (mm)



A DRILLING  
B BORING  
C REAMING  
D BURNISHING  
E THREADING  
X SPECIALS

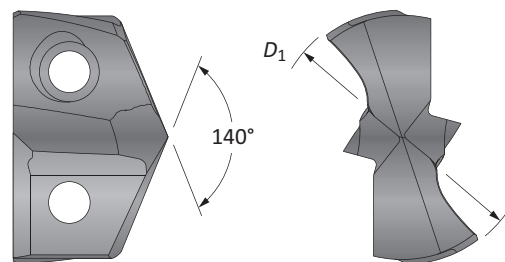

## GEN3SYS XT Pro Drill Inserts

20 Series | Diameter Range: 0.7874" - 0.8660" (20.00mm - 21.99mm)



Fractional Equivalent	Insert				
	$D_1$ inch	$D_1$ mm	Part No. P	Part No. K	Part No. N
-	0.7874	20.00	XTP20-20.00	XTK20-20.00	XTN20-20.00
-	0.7913	20.10	XTP20-20.10	XTK20-20.10	XTN20-20.10
-	0.7953	20.20	XTP20-20.20	XTK20-20.20	XTN20-20.20
51/64	0.7969	20.24	XTP20-20.24	XTK20-20.24	XTN20-20.24
-	0.7992	20.30	XTP20-20.30	XTK20-20.30	XTN20-20.30
-	0.8031	20.40	XTP20-20.40	XTK20-20.40	XTN20-20.40
-	0.8071	20.50	XTP20-20.50	XTK20-20.50	XTN20-20.50
-	0.8110	20.60	XTP20-20.60	XTK20-20.60	XTN20-20.60
13/16	0.8125	20.64	XTP20-20.64	XTK20-20.64	XTN20-20.64
-	0.8150	20.70	XTP20-20.70	XTK20-20.70	XTN20-20.70
-	0.8189	20.80	XTP20-20.80	XTK20-20.80	XTN20-20.80
-	0.8228	20.90	XTP20-20.90	XTK20-20.90	XTN20-20.90
-	0.8268	21.00	XTP20-21.00	XTK20-21.00	XTN20-21.00
-	0.8307	21.10	XTP20-21.10	XTK20-21.10	XTN20-21.10
-	0.8346	21.20	XTP20-21.20	XTK20-21.20	XTN20-21.20
-	0.8386	21.30	XTP20-21.30	XTK20-21.30	XTN20-21.30
-	0.8425	21.40	XTP20-21.40	XTK20-21.40	XTN20-21.40
27/32	0.8438	21.43	XTP20-21.43	XTK20-21.43	XTN20-21.43
-	0.8465	21.50	XTP20-21.50	XTK20-21.50	XTN20-21.50
-	0.8504	21.60	XTP20-21.60	XTK20-21.60	XTN20-21.60
-	0.8543	21.70	XTP20-21.70	XTK20-21.70	XTN20-21.70
-	0.8583	21.80	XTP20-21.80	XTK20-21.80	XTN20-21.80
55/64	0.8594	21.83	XTP20-21.83	XTK20-21.83	XTN20-21.83
-	0.8622	21.90	XTP20-21.90	XTK20-21.90	XTN20-21.90

Inserts sold in multiples of 1

A

DRILLING

B

BORING

C

REAMING

D

BURNISHING

E

THREADING

X

SPECIALS

A20: 68 - 83

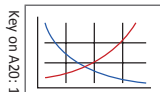

A20: 6 - 9



Sizes not shown are available upon request.

When ordering, please follow the example below:

<b>Imperial:</b>	0.5180", Steel, 13 series = use Part No. <b>XTP13-13.16</b>
<b>Metric:</b>	13.16mm, Steel, 13 series = use Part No. <b>XTP13-13.16</b>

### GEN3SYS XT Pro Drill Insert Holders

20 Series | Diameter Range: 0.7874" - 0.8660" (20.00mm - 21.99mm)

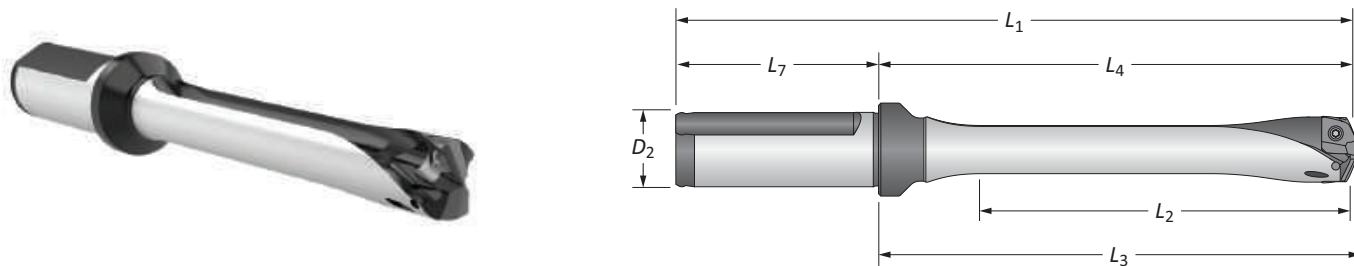

Flute	Body					Shank			Part No.
	Length	L <sub>2</sub>	L <sub>4</sub>	L <sub>3</sub>	L <sub>1</sub>	L <sub>7</sub>	D <sub>2</sub>	Flat	
i Straight	3xD	2-19/32	3-15/16	4-3/64	6-7/32	2-9/32	1	YES	HXT0320S-100F
	3xD	2-19/32	3-15/16	4-3/64	6-7/32	2-9/32	1	NO	HXT0320S-100C
	5xD	4-21/64	5-43/64	5-25/32	7-61/64	2-9/32	1	YES	HXT0520S-100F
	5xD	4-21/64	5-43/64	5-25/32	7-61/64	2-9/32	1	NO	HXT0520S-100C
	7xD	6-1/16	7-13/32	7-33/64	9-11/16	2-9/32	1	YES	HXT0720S-100F
	7xD	6-1/16	7-13/32	7-33/64	9-11/16	2-9/32	1	NO	HXT0720S-100C
	10xD	8-21/32	10	10-7/64	12-9/32	2-9/32	1	YES	HXT1020S-100F
10xD	8-21/32	10	10-7/64	12-9/32	2-9/32	1	NO	HXT1020S-100C	
ii Straight	3xD	66.0	100.0	102.9	156.0	56.0	25.0	YES	HXT0320S-25FM
	3xD	66.0	100.0	102.9	156.0	56.0	25.0	NO	HXT0320S-25CM
	5xD	110.0	144.0	146.9	200.0	56.0	25.0	YES	HXT0520S-25FM
	5xD	110.0	144.0	146.9	200.0	56.0	25.0	NO	HXT0520S-25CM
	7xD	153.9	187.0	190.9	243.0	56.0	25.0	YES	HXT0720S-25FM
	7xD	153.9	187.0	190.9	243.0	56.0	25.0	NO	HXT0720S-25CM
	10xD	219.9	254.0	256.8	310.0	56.0	25.0	YES	HXT1020S-25FM
	10xD	219.9	254.0	256.8	310.0	56.0	25.0	NO	HXT1020S-25CM

#### Connection Accessories

					Admissible Tightening Torque*
7375-IP9-1	7375N-IP9-1	8IP-9	8IP-9TL	8IP-9B	27.0 in-lbs (305 N-cm)

\*Tightening torques are calculated with a friction coefficient of  $\mu = 0.14$  and develop 90% of ultimate yield strength

**⚠ WARNING** Refer to Speed and Feed charts for recommended adjustments to speeds and feeds. Refer to page A20: 86 for deep hole drilling guidelines in this section of the catalog. Visit [www.alliedmachine.com/DeepHoleGuidelines](http://www.alliedmachine.com/DeepHoleGuidelines) for the most up-to-date information and procedures. Factory technical assistance is available for your specific applications through our Application Engineering Team.

i = Imperial (in)  
ii = Metric (mm)

Screws sold in multiples of 10



## GEN3SYS XT Drill Inserts

20 Series | Diameter Range: 0.7874" - 0.8660" (20.00mm - 21.99mm)

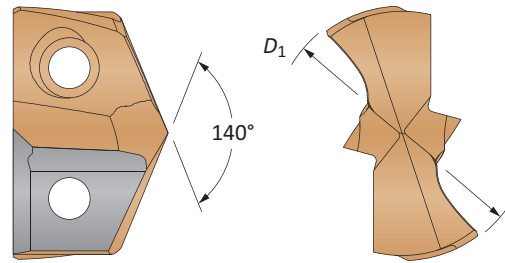
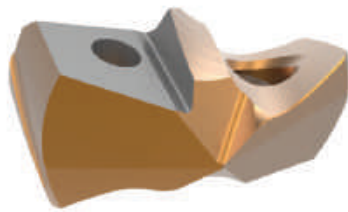

Carbide Substrate	Insert			Standard Part No.	Low Rake Part No.	Cast Iron Part No.	Stainless Part No.
	Fractional Equivalent	D <sub>1</sub> inch	D <sub>1</sub> mm				
C1 (K35)	-	0.7874	20.00	7C120P-20	7C120P-20LR	-	-
	51/64	0.7969	20.24	7C120P-.796	7C120P-.796LR	-	-
	-	0.8071	20.50	7C120P-20.5	7C120P-20.5LR	-	-
	13/16	0.8125	20.64	7C120P-0026	7C120P-0026LR	-	-
	-	0.8268	21.00	7C120P-21	7C120P-21LR	-	-
	27/32	0.8438	21.43	7C120P-0027	7C120P-0027LR	-	-
	-	0.8465	21.50	7C120P-21.5	7C120P-21.5LR	-	-
	55/64	0.8594	21.83	7C120P-.859	7C120P-.859LR	-	-
C2 (K20)	-	0.7874	20.00	7C220P-20	7C220P-20LR	7C220P-20CI	7C220P-20AS
	51/64	0.7969	20.24	7C220P-.796	7C220P-.796LR	7C220P-.796CI	7C220P-.796AS
	-	0.8071	20.50	7C220P-20.5	7C220P-20.5LR	7C220P-20.5CI	7C220P-20.5AS
	13/16	0.8125	20.64	7C220P-0026	7C220P-0026LR	7C220P-0026CI	7C220P-0026AS
	-	0.8268	21.00	7C220P-21	7C220P-21LR	7C220P-21CI	7C220P-21AS
	27/32	0.8438	21.43	7C220P-0027	7C220P-0027LR	7C220P-0027CI	7C220P-0027AS
	-	0.8465	21.50	7C220P-21.5	7C220P-21.5LR	7C220P-21.5CI	7C220P-21.5AS
	55/64	0.8594	21.83	7C220P-.859	7C220P-.859LR	7C220P-.859CI	7C220P-.859AS

Inserts sold in multiples of 1

A20: 68 - 83

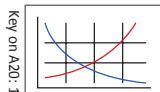

A20: 6 - 9



Sizes not shown are available upon request.  
When ordering, please follow the example below:

<b>Imperial:</b>	0.5200", 13 series, C2 = use Part No. <b>7C213P-.5200</b>
<b>Metric:</b>	13.20mm, 13 series, C2 = use Part No. <b>7C213P-13.20</b>



## GEN3SYS Drill Insert Holders

20 Series | Diameter Range: 0.7874" - 0.8660" (20.00mm - 21.99mm)

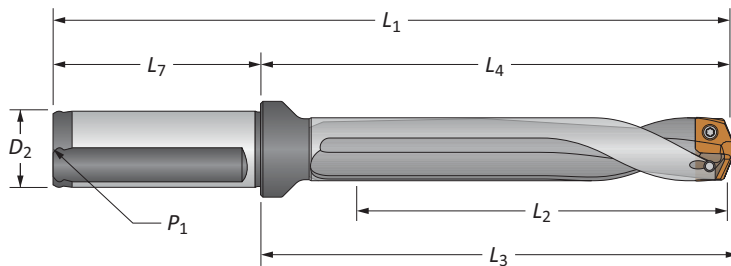

### Straight and Helical

Flute	Length	Body				Shank				Flat	Part No.
		L <sub>2</sub>	L <sub>4</sub>	L <sub>3</sub>	L <sub>1</sub>	L <sub>7</sub>	D <sub>2</sub>	P <sub>1</sub>			
Straight	3xD	2-19/32	3-15/16	4-3/64	6-7/32	2-9/32	1	1/8	YES	<b>60320S-100F</b>	
	5xD	4-21/64	5-43/64	5-25/32	7-61/64	2-9/32	1	1/8	YES	<b>60520S-100F</b>	
	7xD	6-1/16	7-13/32	7-33/64	9-11/16	2-9/32	1	1/8	YES	<b>60720S-100F</b>	
Helical	Stub	15/16	2-17/64	2-3/8	4-35/64	2-9/32	1	1/8	YES	<b>60120H-100F</b>	
	3xD	2-19/32	3-15/16	4-3/64	6-7/32	2-9/32	1	1/8	YES	<b>60320H-100F</b>	
	3xD	2-19/32	3-15/16	4-3/64	6-7/32	2-9/32	1	1/8	NO	<b>60320H-100C</b>	
	5xD	4-21/64	5-43/64	5-25/32	7-61/64	2-9/32	1	1/8	YES	<b>60520H-100F</b>	
	5xD	4-21/64	5-43/64	5-25/32	7-61/64	2-9/32	1	1/8	NO	<b>60520H-100C</b>	
	7xD	6-1/16	7-13/32	7-33/64	9-11/16	2-9/32	1	1/8	YES	<b>60720H-100F</b>	
	7xD	6-1/16	7-13/32	7-33/64	9-11/16	2-9/32	1	1/8	NO	<b>60720H-100C</b>	
	Straight	3xD	66.0	100.0	102.9	156.0	56.0	25.0	1/8*	YES	<b>60320S-25FM</b>
5xD		110.0	144.0	146.9	200.0	56.0	25.0	1/8*	YES	<b>60520S-25FM</b>	
7xD		153.9	187.0	190.9	243.0	56.0	25.0	1/8*	YES	<b>60720S-25FM</b>	
Stub		24.0	57.6	60.4	113.6	56.0	25.0	1/8*	YES	<b>60120H-25FM</b>	
3xD		66.0	100.0	102.9	156.0	56.0	25.0	1/8*	YES	<b>60320H-25FM</b>	
3xD		66.0	100.0	102.9	156.0	56.0	25.0	1/8*	NO	<b>60320H-25CM</b>	
5xD		110.0	144.0	146.9	200.0	56.0	25.0	1/8*	YES	<b>60520H-25FM</b>	
5xD		110.0	144.0	146.9	200.0	56.0	25.0	1/8*	NO	<b>60520H-25CM</b>	
7xD		153.9	187.0	190.9	243.0	56.0	25.0	1/8*	YES	<b>60720H-25FM</b>	
7xD		153.9	187.0	190.9	243.0	56.0	25.0	1/8*	NO	<b>60720H-25CM</b>	

\*Thread to BSP and ISO 7-1

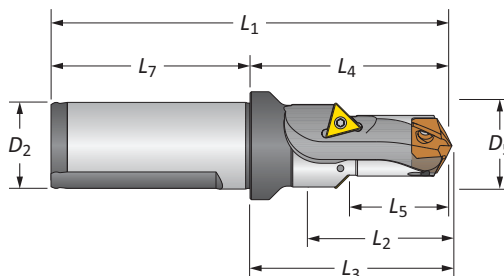

### Drill / Chamfer

Step	Body				Shank			Part No.	Chamfer Insert
	D <sub>5</sub>	L <sub>5</sub>	L <sub>2</sub>	L <sub>4</sub>	L <sub>3</sub>	L <sub>1</sub>	L <sub>7</sub>		
1-5/64	1-3/16	1-29/64	2-17/64	2-3/8	4-35/64	2-9/32	1	<b>60120C45-100F</b>	TCMT-110204
27.2	30.0	37.1	57.6	60.4	113.6	56.0	25.0	<b>60120C45-25FM</b>	TCMT-110204

### Connection Accessories

Insert Screws	Nylon Locking Screws	Insert Driver	Preset Torque Hand Driver	Replacement Tips	Admissible Tightening Torque*
7375-IP9-1	7375N-IP9-1	8IP-9	8IP-9TL	8IP-9B	27.0 in-lbs (305 N-cm)

\*Tightening torques are calculated with a friction coefficient of  $\mu = 0.14$  and develop 90% of ultimate yield strength



Chamfer inserts sold separately in multiples of 10 | Screws sold in multiples of 10

= Imperial (in)  
 = Metric (mm)

## GEN3SYS XT Pro Drill Inserts

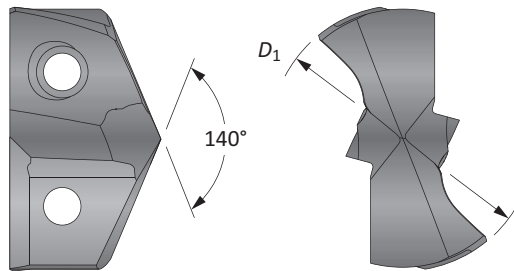
22 Series | Diameter Range: 0.8661" - 0.9448" (22.00mm - 23.99mm)



Fractional Equivalent	Insert				
	$D_1$ inch	$D_1$ mm	Part No. <b>P</b>	Part No. <b>K</b>	Part No. <b>N</b>
-	0.8661	22.00	XTP22-22.00	XTK22-22.00	XTN22-22.00
-	0.8701	22.10	XTP22-22.10	XTK22-22.10	XTN22-22.10
-	0.8740	22.20	XTP22-22.20	XTK22-22.20	XTN22-22.20
7/8	0.8750	22.23	XTP22-22.23	XTK22-22.23	XTN22-22.23
-	0.8780	22.30	XTP22-22.30	XTK22-22.30	XTN22-22.30
-	0.8819	22.40	XTP22-22.40	XTK22-22.40	XTN22-22.40
-	0.8858	22.50	XTP22-22.50	XTK22-22.50	XTN22-22.50
57/64	0.8906	22.62	XTP22-22.62	XTK22-22.62	XTN22-22.62
-	0.8937	22.70	XTP22-22.70	XTK22-22.70	XTN22-22.70
-	0.8976	22.80	XTP22-22.80	XTK22-22.80	XTN22-22.80
-	0.9016	22.90	XTP22-22.90	XTK22-22.90	XTN22-22.90
-	0.9055	23.00	XTP22-23.00	XTK22-23.00	XTN22-23.00
29/32	0.9063	23.02	XTP22-23.02	XTK22-23.02	XTN22-23.02
-	0.9094	23.10	XTP22-23.10	XTK22-23.10	XTN22-23.10
-	0.9134	23.20	XTP22-23.20	XTK22-23.20	XTN22-23.20
-	0.9173	23.30	XTP22-23.30	XTK22-23.30	XTN22-23.30
59/64	0.9219	23.42	XTP22-23.42	XTK22-23.42	XTN22-23.42
-	0.9252	23.50	XTP22-23.50	XTK22-23.50	XTN22-23.50
-	0.9291	23.60	XTP22-23.60	XTK22-23.60	XTN22-23.60
-	0.9331	23.70	XTP22-23.70	XTK22-23.70	XTN22-23.70
15/16	0.9375	23.81	XTP22-23.81	XTK22-23.81	XTN22-23.81
-	0.9409	23.90	XTP22-23.90	XTK22-23.90	XTN22-23.90

Inserts sold in multiples of 1

A20: 68 - 83

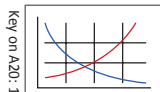

A20: 6 - 9



Key on A20: 1

Sizes not shown are available upon request.  
When ordering, please follow the example below:

<b>Imperial:</b>	0.5180", Steel, 13 series = use Part No. <b>XTP13-13.16</b>
<b>Metric:</b>	13.16mm, Steel, 13 series = use Part No. <b>XTP13-13.16</b>

**GEN3SYS XT Pro Drill Insert Holders**

22 Series | Diameter Range: 0.8661" - 0.9448" (22.00mm - 23.99mm)

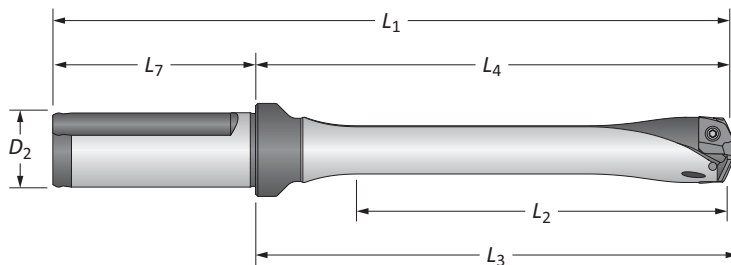

Flute	Body					Shank			Part No.
	Length	L <sub>2</sub>	L <sub>4</sub>	L <sub>3</sub>	L <sub>1</sub>	L <sub>7</sub>	D <sub>2</sub>	Flat	
i Straight 	3xD	2-53/64	4-9/64	4-17/64	6-27/64	2-9/32	1	YES	HXT0322S-100F
	3xD	2-53/64	4-9/64	4-17/64	6-27/64	2-9/32	1	NO	HXT0322S-100C
	5xD	4-23/32	6-1/32	6-5/32	8-5/16	2-9/32	1	YES	HXT0522S-100F
	5xD	4-23/32	6-1/32	6-5/32	8-5/16	2-9/32	1	NO	HXT0522S-100C
	7xD	6-39/64	7-59/64	8-3/64	10-13/64	2-9/32	1	YES	HXT0722S-100F
	7xD	6-39/64	7-59/64	8-3/64	10-13/64	2-9/32	1	NO	HXT0722S-100C
	10xD	9-7/16	10-3/4	10-7/8	13-1/32	2-9/32	1	YES	HXT1022S-100F
10xD	9-7/16	10-3/4	10-7/8	13-1/32	2-9/32	1	NO	HXT1022S-100C	
ii Straight 	3xD	72.0	105.1	108.3	161.1	56.0	25.0	YES	HXT0322S-25FM
	3xD	72.0	105.1	108.3	161.1	56.0	25.0	NO	HXT0322S-25CM
	5xD	120.0	153.2	156.2	209.2	56.0	25.0	YES	HXT0522S-25FM
	5xD	120.0	153.2	156.2	209.2	56.0	25.0	NO	HXT0522S-25CM
	7xD	167.9	201.2	204.2	257.2	56.0	25.0	YES	HXT0722S-25FM
	7xD	167.9	201.2	204.2	257.2	56.0	25.0	NO	HXT0722S-25CM
	10xD	239.9	273.0	276.2	329.0	56.0	25.0	YES	HXT1022S-25FM
	10xD	239.9	273.0	276.2	329.0	56.0	25.0	NO	HXT1022S-25CM

**Connection Accessories**

					<b>Admissible Tightening Torque*</b>
739-IP9-1	739N-IP9-1	8IP-9	8IP-9TL	8IP-9B	27.0 in-lbs (305 N-cm)

\*Tightening torques are calculated with a friction coefficient of  $\mu = 0.14$  and develop 90% of ultimate yield strength

**⚠ WARNING** Refer to Speed and Feed charts for recommended adjustments to speeds and feeds. Refer to page A20: 86 for deep hole drilling guidelines in this section of the catalog. Visit [www.alliedmachine.com/DeepHoleGuidelines](http://www.alliedmachine.com/DeepHoleGuidelines) for the most up-to-date information and procedures. Factory technical assistance is available for your specific applications through our Application Engineering Team.

i = Imperial (in)  
ii = Metric (mm)

Screws sold in multiples of 10

## GEN3SYS XT Drill Inserts

22 Series | Diameter Range: 0.8661" - 0.9448" (22.00mm - 23.99mm)

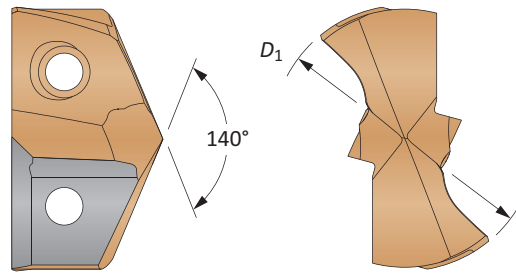

Carbide Substrate	Insert			Standard Part No.	Low Rake Part No.	Cast Iron Part No.	Stainless Part No.
	Fractional Equivalent	$D_1$ inch	$D_1$ mm				
C1 (K35)		0.8661	22.00	<b>7C122P-22</b>	<b>7C122P-22LR</b>	-	-
	7/8	0.8750	22.23	<b>7C122P-0028</b>	<b>7C122P-0028LR</b>	-	-
	57/64	0.8906	22.61	<b>7C122P-.890</b>	<b>7C122P-.890LR</b>	-	-
		0.9055	23.00	<b>7C122P-23</b>	<b>7C122P-23LR</b>	-	-
	29/32	0.9063	23.02	<b>7C122P-0029</b>	<b>7C122P-0029LR</b>	-	-
	59/64	0.9219	23.42	<b>7C122P-.921</b>	<b>7C122P-.921LR</b>	-	-
	15/16	0.9375	23.81	<b>7C122P-0030</b>	<b>7C122P-0030LR</b>	-	-
C2 (K20)		0.8661	22.00	<b>7C222P-22</b>	<b>7C222P-22LR</b>	<b>7C222P-22CI</b>	<b>7C222P-22AS</b>
	7/8	0.8750	22.23	<b>7C222P-0028</b>	<b>7C222P-0028LR</b>	<b>7C222P-0028CI</b>	<b>7C222P-0028AS</b>
	57/64	0.8906	22.61	<b>7C222P-.890</b>	<b>7C222P-.890LR</b>	<b>7C222P-.890CI</b>	<b>7C222P-.890AS</b>
		0.9055	23.00	<b>7C222P-23</b>	<b>7C222P-23LR</b>	<b>7C222P-23CI</b>	<b>7C222P-23AS</b>
	29/32	0.9063	23.02	<b>7C222P-0029</b>	<b>7C222P-0029LR</b>	<b>7C222P-0029CI</b>	<b>7C222P-0029AS</b>
	59/64	0.9219	23.42	<b>7C222P-.921</b>	<b>7C222P-.921LR</b>	<b>7C222P-.921CI</b>	<b>7C222P-.921AS</b>
	15/16	0.9375	23.81	<b>7C222P-0030</b>	<b>7C222P-0030LR</b>	<b>7C222P-0030CI</b>	<b>7C222P-0030AS</b>

Inserts sold in multiples of 1

A20: 68 - 83

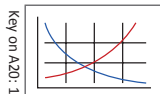

A20: 6 - 9



Sizes not shown are available upon request.  
When ordering, please follow the example below:

<b>Imperial:</b>	0.5200", 13 series, C2 = use Part No. <b>7C213P-.5200</b>
<b>Metric:</b>	13.20mm, 13 series, C2 = use Part No. <b>7C213P-13.20</b>



## GEN3SYS Drill Insert Holders

22 Series | Diameter Range: 0.8661" - 0.9448" (22.00mm - 23.99mm)

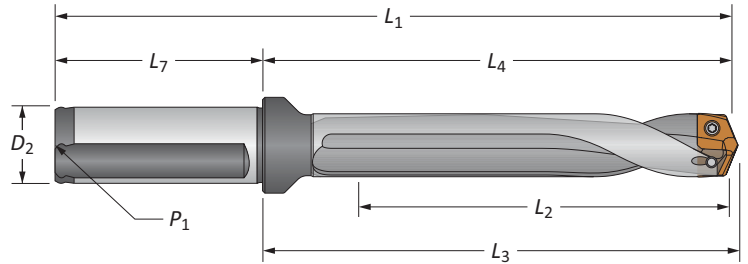

### Straight and Helical

Flute	Length	Body				Shank				Flat	Part No.
		L <sub>2</sub>	L <sub>4</sub>	L <sub>3</sub>	L <sub>1</sub>	L <sub>7</sub>	D <sub>2</sub>	P <sub>1</sub>			
	3xD	2-53/64	4-9/64	4-17/64	6-27/64	2-9/32	1	1/8	YES	<b>60322S-100F</b>	
	5xD	4-23/32	6-1/32	6-5/32	8-5/16	2-9/32	1	1/8	YES	<b>60522S-100F</b>	
	7xD	6-39/64	7-59/64	8-3/64	10-13/64	2-9/32	1	1/8	YES	<b>60722S-100F</b>	
	Stub	1-1/16	2-23/64	2-31/64	4-41/64	2-9/32	1	1/8	YES	<b>60122H-100F</b>	
	3xD	2-53/64	4-9/64	4-17/64	6-27/64	2-9/32	1	1/8	YES	<b>60322H-100F</b>	
	3xD	2-53/64	4-9/64	4-17/64	6-27/64	2-9/32	1	1/8	NO	<b>60322H-100C</b>	
	5xD	4-23/32	6-1/32	6-5/32	8-5/16	2-9/32	1	1/8	YES	<b>60522H-100F</b>	
	5xD	4-23/32	6-1/32	6-5/32	8-5/16	2-9/32	1	1/8	NO	<b>60522H-100C</b>	
	7xD	6-39/64	7-59/64	8-3/64	10-13/64	2-9/32	1	1/8	YES	<b>60722H-100F</b>	
	7xD	6-39/64	7-59/64	8-3/64	10-13/64	2-9/32	1	1/8	NO	<b>60722H-100C</b>	
	3xD	72.0	105.1	108.3	161.1	56.0	25.0	1/8*	YES	<b>60322S-25FM</b>	
	5xD	120.0	153.2	156.2	209.2	56.0	25.0	1/8*	YES	<b>60522S-25FM</b>	
	7xD	167.9	201.2	204.2	257.2	56.0	25.0	1/8*	YES	<b>60722S-25FM</b>	
	Stub	27.0	60.1	63.0	116.1	56.0	25.0	1/8*	YES	<b>60122H-25FM</b>	
	3xD	72.0	105.1	108.3	161.1	56.0	25.0	1/8*	YES	<b>60322H-25FM</b>	
	3xD	72.0	105.1	108.3	161.1	56.0	25.0	1/8*	NO	<b>60322H-25CM</b>	
	5xD	120.0	153.2	156.2	209.2	56.0	25.0	1/8*	YES	<b>60522H-25FM</b>	
	5xD	120.0	153.2	156.2	209.2	56.0	25.0	1/8*	NO	<b>60522H-25CM</b>	
	7xD	167.9	201.2	204.2	257.2	56.0	25.0	1/8*	YES	<b>60722H-25FM</b>	
	7xD	167.9	201.2	204.2	257.2	56.0	25.0	1/8*	NO	<b>60722H-25CM</b>	

\*Thread to BSP and ISO 7-1

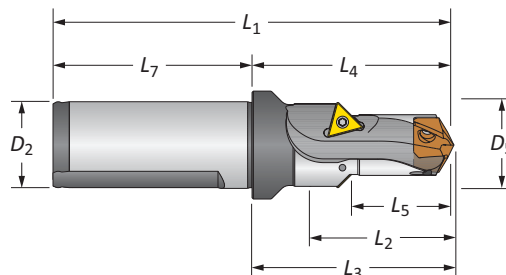

### Drill / Chamfer

Step	Body				Shank		Part No.	Chamfer Insert		
	D <sub>5</sub>	L <sub>5</sub>	L <sub>2</sub>	L <sub>4</sub>	L <sub>3</sub>	L <sub>1</sub>			L <sub>7</sub>	D <sub>2</sub>
	1-9/64	1-19/64	1-19/32	2-23/64	2-31/64	4-41/64	2-9/32	1	<b>60122C45-100F</b>	TCMT-110204
	29.0	33.0	40.5	60.0	63.0	116.0	56.0	25.0	<b>60122C45-25FM</b>	TCMT-110204

### Connection Accessories

Insert Screws	Nylon Locking Screws	Insert Driver	Preset Torque Hand Driver	Replacement Tips	Admissible Tightening Torque*
739-IP9-1	739N-IP9-1	8IP-9	8IP-9TL	8IP-9B	27.0 in-lbs (305 N-cm)

\*Tightening torques are calculated with a friction coefficient of  $\mu = 0.14$  and develop 90% of ultimate yield strength



Chamfer inserts sold separately in multiples of 10 | Screws sold in multiples of 10

= Imperial (in)  
 = Metric (mm)

## GEN3SYS XT Pro Drill Inserts

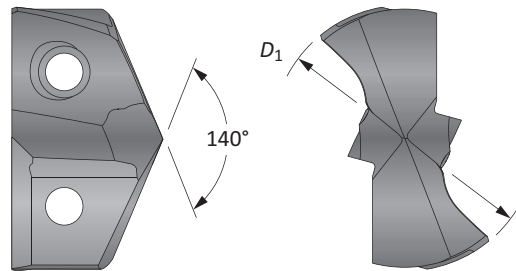
24 Series | Diameter Range: 0.9449" - 1.0235" (24.00mm - 25.99mm)



Fractional Equivalent	Insert				
	$D_1$ inch	$D_1$ mm	Part No. <b>P</b>	Part No. <b>K</b>	Part No. <b>N</b>
-	0.9449	24.00	XTP24-24.00	XTK24-24.00	XTN24-24.00
-	0.9488	24.10	XTP24-24.10	XTK24-24.10	XTN24-24.10
-	0.9528	24.20	XTP24-24.20	XTK24-24.20	XTN24-24.20
-	0.9567	24.30	XTP24-24.30	XTK24-24.30	XTN24-24.30
-	0.9606	24.40	XTP24-24.40	XTK24-24.40	XTN24-24.40
-	0.9646	24.50	XTP24-24.50	XTK24-24.50	XTN24-24.50
31/32	0.9688	24.61	XTP24-24.61	XTK24-24.61	XTN24-24.61
-	0.9724	24.70	XTP24-24.70	XTK24-24.70	XTN24-24.70
-	0.9764	24.80	XTP24-24.80	XTK24-24.80	XTN24-24.80
-	0.9803	24.90	XTP24-24.90	XTK24-24.90	XTN24-24.90
63/64	0.9843	25.00	XTP24-25.00	XTK24-25.00	XTN24-25.00
-	0.9882	25.10	XTP24-25.10	XTK24-25.10	XTN24-25.10
-	0.9921	25.20	XTP24-25.20	XTK24-25.20	XTN24-25.20
-	0.9961	25.30	XTP24-25.30	XTK24-25.30	XTN24-25.30
1	1.0000	25.40	XTP24-25.40	XTK24-25.40	XTN24-25.40
-	1.0039	25.50	XTP24-25.50	XTK24-25.50	XTN24-25.50
-	1.0080	25.60	XTP24-25.60	XTK24-25.60	XTN24-25.60
-	1.0118	25.70	XTP24-25.70	XTK24-25.70	XTN24-25.70
1-1/64	1.0150	25.78	XTP24-25.78	XTK24-25.78	XTN24-25.78
-	1.0197	25.90	XTP24-25.90	XTK24-25.90	XTN24-25.90

Inserts sold in multiples of 1

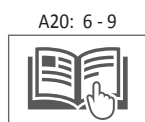
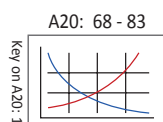

Sizes not shown are available upon request.	
When ordering, please follow the example below:	
<b>Imperial:</b>	0.5180", Steel, 13 series = use Part No. <b>XTP13-13.16</b>
<b>Metric:</b>	13.16mm, Steel, 13 series = use Part No. <b>XTP13-13.16</b>

### GEN3SYS XT Pro Drill Insert Holders

24 Series | Diameter Range: 0.9449" - 1.0235" (24.00mm - 25.99mm)

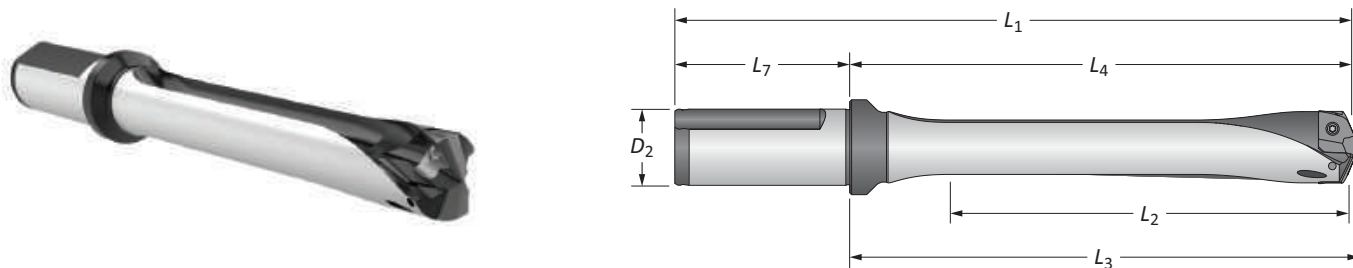

Flute	Body					Shank			Part No.
	Length	L <sub>2</sub>	L <sub>4</sub>	L <sub>3</sub>	L <sub>1</sub>	L <sub>7</sub>	D <sub>2</sub>	Flat	
i Straight	3xD	3-1/16	4-31/64	4-19/32	6-49/64	2-9/32	1	YES	HXT0324S-100F
	3xD	3-1/16	4-31/64	4-19/32	6-49/64	2-9/32	1	NO	HXT0324S-100C
	5xD	5-7/64	6-17/32	6-41/64	8-13/16	2-9/32	1	YES	HXT0524S-100F
	5xD	5-7/64	6-17/32	6-41/64	8-13/16	2-9/32	1	NO	HXT0524S-100C
	7xD	7-5/32	8-37/64	8-11/16	10-55/64	2-9/32	1	YES	HXT0724S-100F
	7xD	7-5/32	8-37/64	8-11/16	10-55/64	2-9/32	1	NO	HXT0724S-100C
	10xD	10-15/64	11-41/64	11-49/64	13-59/64	2-9/32	1	YES	HXT1024S-100F
10xD	10-15/64	11-41/64	11-49/64	13-59/64	2-9/32	1	NO	HXT1024S-100C	
ii Straight	3xD	78.0	113.9	116.8	169.9	56.0	25.0	YES	HXT0324S-25FM
	3xD	78.0	113.9	116.8	169.9	56.0	25.0	NO	HXT0324S-25CM
	5xD	130.0	165.9	168.7	221.9	56.0	25.0	YES	HXT0524S-25FM
	5xD	130.0	165.9	168.7	221.9	56.0	25.0	NO	HXT0524S-25CM
	7xD	181.9	217.9	220.7	273.9	56.0	25.0	YES	HXT0724S-25FM
	7xD	181.9	217.9	220.7	273.9	56.0	25.0	NO	HXT0724S-25CM
	10xD	259.9	295.7	298.7	351.7	56.0	25.0	YES	HXT1024S-25FM
	10xD	259.9	295.7	298.7	351.7	56.0	25.0	NO	HXT1024S-25CM

#### Connection Accessories

					Admissible Tightening Torque*
739-IP9-1	739N-IP9-1	8IP-9	8IP-9TL	8IP-9B	27.0 in-lbs (305 N-cm)

\*Tightening torques are calculated with a friction coefficient of  $\mu = 0.14$  and develop 90% of ultimate yield strength

**⚠ WARNING** Refer to Speed and Feed charts for recommended adjustments to speeds and feeds. Refer to page A20: 86 for deep hole drilling guidelines in this section of the catalog. Visit [www.alliedmachine.com/DeepHoleGuidelines](http://www.alliedmachine.com/DeepHoleGuidelines) for the most up-to-date information and procedures. Factory technical assistance is available for your specific applications through our Application Engineering Team.

i = Imperial (in)  
m = Metric (mm)

Screws sold in multiples of 10



## GEN3SYS XT Drill Inserts

24 Series | Diameter Range: 0.9449" - 1.0235" (24.00mm - 25.99mm)

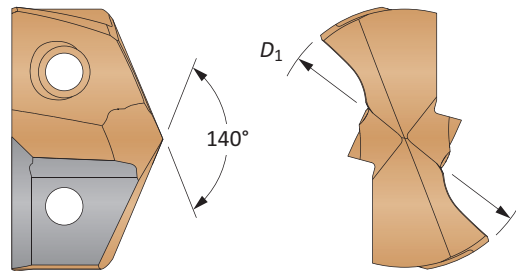
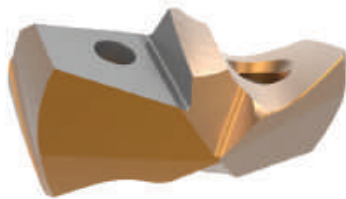

Carbide Substrate	Insert			Standard Part No.	Low Rake Part No.	Cast Iron Part No.	Stainless Part No.
	Fractional Equivalent	$D_1$ inch	$D_1$ mm				
C1 (K35)	-	0.9449	24.00	<b>7C124P-24</b>	<b>7C124P-24LR</b>	-	-
	31/32	0.9688	24.61	<b>7C124P-0031</b>	<b>7C124P-0031LR</b>	-	-
	63/64	0.9843	25.00	<b>7C124P-25</b>	<b>7C124P-25LR</b>	-	-
	1	1.0000	25.40	<b>7C124P-0100</b>	<b>7C124P-0100LR</b>	-	-
	-	1.0080	25.60	<b>7C124P-1.008</b>	<b>7C124P-1.008LR</b>	-	-
	1-1/64	1.0156	25.78	<b>7C124P-1.015</b>	<b>7C124P-1.015LR</b>	-	-
C2 (K20)	-	0.9449	24.00	<b>7C224P-24</b>	<b>7C224P-24LR</b>	<b>7C224P-24CI</b>	<b>7C224P-24AS</b>
	31/32	0.9688	24.61	<b>7C224P-0031</b>	<b>7C224P-0031LR</b>	<b>7C224P-0031CI</b>	<b>7C224P-0031AS</b>
	63/64	0.9843	25.00	<b>7C224P-25</b>	<b>7C224P-25LR</b>	<b>7C224P-25CI</b>	<b>7C224P-25AS</b>
	1	1.0000	25.40	<b>7C224P-0100</b>	<b>7C224P-0100LR</b>	<b>7C224P-0100CI</b>	<b>7C224P-0100AS</b>
	-	1.0080	25.60	<b>7C224P-1.008</b>	<b>7C224P-1.008LR</b>	<b>7C224P-1.008CI</b>	<b>7C224P-1.008AS</b>
	1-1/64	1.0156	25.78	<b>7C224P-1.015</b>	<b>7C224P-1.015LR</b>	<b>7C224P-1.015CI</b>	<b>7C224P-1.015AS</b>

Inserts sold in multiples of 1

A20: 68 - 83

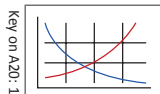

A20: 6 - 9



Key on A20: 1

Sizes not shown are available upon request.  
When ordering, please follow the example below:

<b>Imperial:</b>	0.5200", 13 series, C2 = use Part No. <b>7C213P-.5200</b>
<b>Metric:</b>	13.20mm, 13 series, C2 = use Part No. <b>7C213P-13.20</b>





## GEN3SYS Drill Insert Holders

24 Series | Diameter Range: 0.9449" - 1.0235" (24.00mm - 25.99mm)

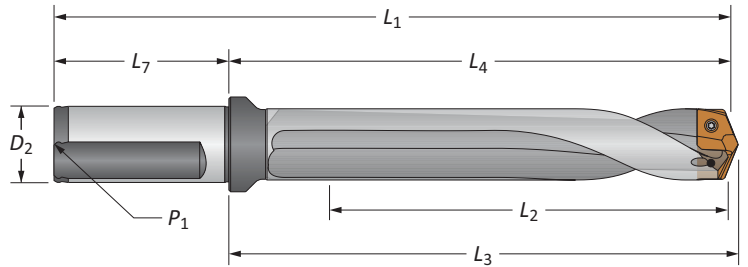

### Straight and Helical

Flute	Length	Body				Shank				Flat	Part No.
		L <sub>2</sub>	L <sub>4</sub>	L <sub>3</sub>	L <sub>1</sub>	L <sub>7</sub>	D <sub>2</sub>	P <sub>1</sub>			
Straight	3xD	3-1/16	4-31/64	4-19/32	6-49/64	2-9/32	1	1/8	YES	<b>60324S-100F</b>	
	5xD	5-7/64	6-17/32	6-41/64	8-13/16	2-9/32	1	1/8	YES	<b>60524S-100F</b>	
	7xD	7-5/32	8-37/64	8-11/16	10-55/64	2-9/32	1	1/8	YES	<b>60724S-100F</b>	
Helical	Stub	1-1/8	2-17/32	2-41/64	4-13/16	2-9/32	1	1/8	YES	<b>60124H-100F</b>	
	3xD	3-1/16	4-31/64	4-19/32	6-49/64	2-9/32	1	1/8	YES	<b>60324H-100F</b>	
	3xD	3-1/16	4-31/64	4-19/32	6-49/64	2-9/32	1	1/8	NO	<b>60324H-100C</b>	
	5xD	5-7/64	6-17/32	6-41/64	8-13/16	2-9/32	1	1/8	YES	<b>60524H-100F</b>	
	5xD	5-7/64	6-17/32	6-41/64	8-13/16	2-9/32	1	1/8	NO	<b>60524H-100C</b>	
	7xD	7-5/32	8-37/64	8-11/16	10-55/64	2-9/32	1	1/8	YES	<b>60724H-100F</b>	
	7xD	7-5/32	8-37/64	8-11/16	10-55/64	2-9/32	1	1/8	NO	<b>60724H-100C</b>	
Straight	3xD	78.0	113.9	116.8	169.9	56.0	25.0	1/8*	YES	<b>60324S-25FM</b>	
	5xD	130.0	165.9	168.7	221.9	56.0	25.0	1/8*	YES	<b>60524S-25FM</b>	
	7xD	181.9	217.9	220.7	273.9	56.0	25.0	1/8*	YES	<b>60724S-25FM</b>	
	Stub	28.5	64.2	67.1	120.1	56.0	25.0	1/8*	YES	<b>60124H-25FM</b>	
	Helical	3xD	78.0	113.9	116.8	169.9	56.0	25.0	1/8*	YES	<b>60324H-25FM</b>
		3xD	78.0	113.9	116.8	169.9	56.0	25.0	1/8*	NO	<b>60324H-25CM</b>
		5xD	130.0	165.9	168.7	221.9	56.0	25.0	1/8*	YES	<b>60524H-25FM</b>
		5xD	130.0	165.9	168.7	221.9	56.0	25.0	1/8*	NO	<b>60524H-25CM</b>
		7xD	181.9	217.9	220.7	273.9	56.0	25.0	1/8*	YES	<b>60724H-25FM</b>
		7xD	181.9	217.9	220.7	273.9	56.0	25.0	1/8*	NO	<b>60724H-25CM</b>

\*Thread to BSP and ISO 7-1

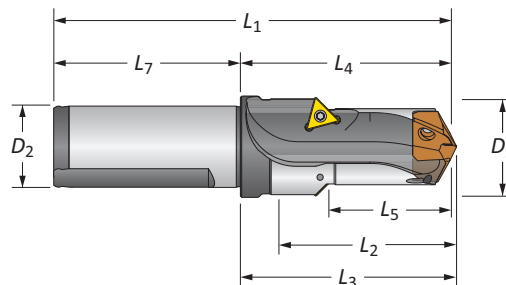

### Drill / Chamfer

Step	Body					Shank		Part No.	Chamfer Insert
	D <sub>5</sub>	L <sub>5</sub>	L <sub>2</sub>	L <sub>4</sub>	L <sub>3</sub>	L <sub>1</sub>	L <sub>7</sub>		
1-7/32	1-27/64	1-51/64	2-17/32	2-41/64	4-13/16	2-9/32	1	<b>60124C45-100F</b>	TCMT-110204
31.0	36.0	45.5	64.2	67.1	120.2	56.0	25.0	<b>60124C45-25FM</b>	TCMT-110204

### Connection Accessories

Insert Screws	Nylon Locking Screws	Insert Driver	Preset Torque Hand Driver	Replacement Tips	Admissible Tightening Torque*
739-IP9-1	739N-IP9-1	8IP-9	8IP-9TL	8IP-9B	27.0 in-lbs (305 N-cm)

\*Tightening torques are calculated with a friction coefficient of  $\mu = 0.14$  and develop 90% of ultimate yield strength



Chamfer inserts sold separately in multiples of 10 | Screws sold in multiples of 10

= Imperial (in)  
 = Metric (mm)

**GEN3SYS XT Pro Drill Inserts**

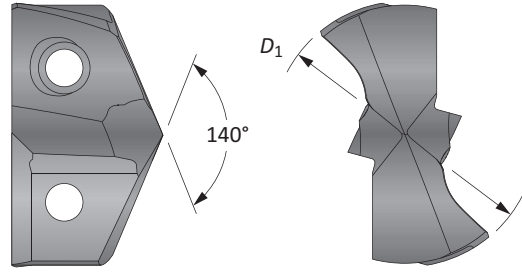
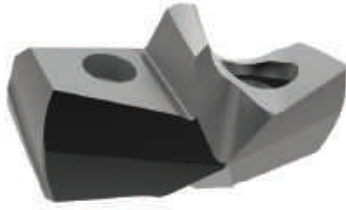
26 Series | Diameter Range: 1.0236" - 1.1416" (26.00mm - 28.99mm)



Fractional Equivalent	Insert				
	D <sub>1</sub> inch	D <sub>1</sub> mm	Part No. <b>P</b>	Part No. <b>K</b>	Part No. <b>N</b>
-	1.0236	26.00	XTP26-26.00	XTK26-26.00	XTN26-26.00
-	1.0276	26.10	XTP26-26.10	XTK26-26.10	XTN26-26.10
1-1/32	1.0313	26.20	XTP26-26.20	XTK26-26.20	XTN26-26.20
-	1.0354	26.30	XTP26-26.30	XTK26-26.30	XTN26-26.30
-	1.0394	26.40	XTP26-26.40	XTK26-26.40	XTN26-26.40
-	1.0433	26.50	XTP26-26.50	XTK26-26.50	XTN26-26.50
1-3/64	1.0469	26.59	XTP26-26.59	XTK26-26.59	XTN26-26.59
-	1.0472	26.60	XTP26-26.60	XTK26-26.60	XTN26-26.60
-	1.0512	26.70	XTP26-26.70	XTK26-26.70	XTN26-26.70
-	1.0551	26.80	XTP26-26.80	XTK26-26.80	XTN26-26.80
-	1.0591	26.90	XTP26-26.90	XTK26-26.90	XTN26-26.90
1-1/16	1.0625	26.99	XTP26-26.99	XTK26-26.99	XTN26-26.99
-	1.0630	27.00	XTP26-27.00	XTK26-27.00	XTN26-27.00
-	1.0669	27.10	XTP26-27.10	XTK26-27.10	XTN26-27.10
-	1.0709	27.20	XTP26-27.20	XTK26-27.20	XTN26-27.20
-	1.0748	27.30	XTP26-27.30	XTK26-27.30	XTN26-27.30
-	1.0787	27.40	XTP26-27.40	XTK26-27.40	XTN26-27.40
-	1.0827	27.50	XTP26-27.50	XTK26-27.50	XTN26-27.50
-	1.0866	27.60	XTP26-27.60	XTK26-27.60	XTN26-27.60
-	1.0906	27.70	XTP26-27.70	XTK26-27.70	XTN26-27.70
1-3/32	1.0938	27.78	XTP26-27.78	XTK26-27.78	XTN26-27.78
-	1.0984	27.90	XTP26-27.90	XTK26-27.90	XTN26-27.90
-	1.1024	28.00	XTP26-28.00	XTK26-28.00	XTN26-28.00
-	1.1063	28.10	XTP26-28.10	XTK26-28.10	XTN26-28.10
1-7/64	1.1090	28.17	XTP26-28.17	XTK26-28.17	XTN26-28.17
-	1.1102	28.20	XTP26-28.20	XTK26-28.20	XTN26-28.20
-	1.1142	28.30	XTP26-28.30	XTK26-28.30	XTN26-28.30
-	1.1181	28.40	XTP26-28.40	XTK26-28.40	XTN26-28.40
-	1.1220	28.50	XTP26-28.50	XTK26-28.50	XTN26-28.50
1-1/8	1.1250	28.58	XTP26-28.58	XTK26-28.58	XTN26-28.58
-	1.1299	28.70	XTP26-28.70	XTK26-28.70	XTN26-28.70
-	1.1339	28.80	XTP26-28.80	XTK26-28.80	XTN26-28.80
-	1.1378	28.90	XTP26-28.90	XTK26-28.90	XTN26-28.90

Inserts sold in multiples of 1

A20: 68 - 83

A20: 6 - 9

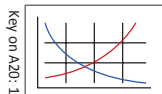



Sizes not shown are available upon request. When ordering, please follow the example below:	
<b>Imperial:</b>	0.5180", Steel, 13 series = use Part No. <b>XTP13-13.16</b>
<b>Metric:</b>	13.16mm, Steel, 13 series = use Part No. <b>XTP13-13.16</b>

**GEN3SYS XT Pro Drill Insert Holders**

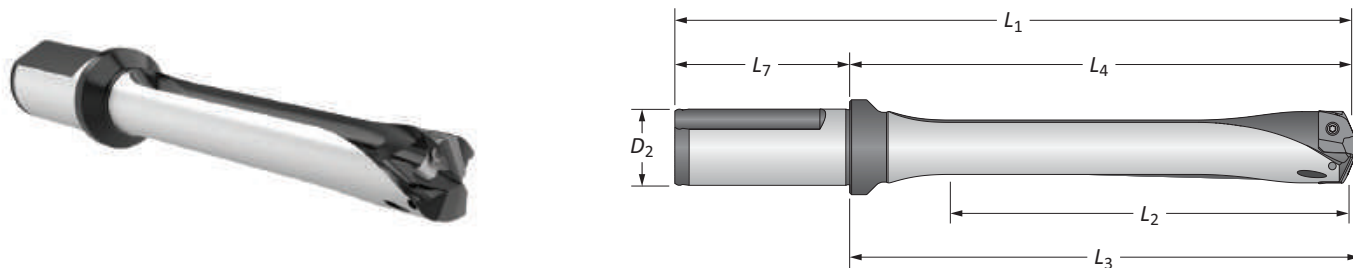
26 Series | Diameter Range: 1.0236" - 1.1416" (26.00mm - 28.99mm)



Flute	Body					Shank			Part No.
	Length	L <sub>2</sub>	L <sub>4</sub>	L <sub>3</sub>	L <sub>1</sub>	L <sub>7</sub>	D <sub>2</sub>	Flat	
i Straight 	3xD	3-27/64	5-1/16	5-11/64	7-11/32	2-9/32	1-1/4	YES	HXT0326S-125F
	3xD	3-27/64	5-1/16	5-11/64	7-11/32	2-9/32	1-1/4	NO	HXT0326S-125C
	5xD	5-45/64	7-11/32	7-29/64	9-5/8	2-9/32	1-1/4	YES	HXT0526S-125F
	5xD	5-45/64	7-11/32	7-29/64	9-5/8	2-9/32	1-1/4	NO	HXT0526S-125C
	7xD	7-63/64	9-5/8	9-47/64	11-29/32	2-9/32	1-1/4	YES	HXT0726S-125F
	7xD	7-63/64	9-5/8	9-47/64	11-29/32	2-9/32	1-1/4	NO	HXT0726S-125C
	10xD	11-13/32	13-3/64	13-11/64	15-21/64	2-9/32	1-1/4	YES	HXT1026S-125F
10xD	11-13/32	13-3/64	13-11/64	15-21/64	2-9/32	1-1/4	NO	HXT1026S-125C	
ii Straight 	3xD	87.0	128.6	131.4	188.6	60.0	32.0	YES	HXT0326S-32FM
	3xD	87.0	128.6	131.4	188.6	60.0	32.0	NO	HXT0326S-32CM
	5xD	145.0	186.5	189.4	246.5	60.0	32.0	YES	HXT0526S-32FM
	5xD	145.0	186.5	189.4	246.5	60.0	32.0	NO	HXT0526S-32CM
	7xD	202.9	244.5	247.4	304.5	60.0	32.0	YES	HXT0726S-32FM
	7xD	202.9	244.5	247.4	304.5	60.0	32.0	NO	HXT0726S-32CM
	10xD	289.9	331.4	334.4	391.4	60.0	32.0	YES	HXT1026S-32FM
	10xD	289.9	331.4	334.4	391.4	60.0	32.0	NO	HXT1026S-32CM

**Connection Accessories**

Insert Screws	Nylon Locking Screws	Insert Driver	Preset Torque Hand Driver	Replacement Tips	Admissible Tightening Torque*
7495-IP15-1	7495N-IP15-1	8IP-15	8IP-15TL	8IP-15B	61.0 in-lbs (690 N-cm)

\*Tightening torques are calculated with a friction coefficient of  $\mu = 0.14$  and develop 90% of ultimate yield strength

**WARNING** Refer to Speed and Feed charts for recommended adjustments to speeds and feeds. Refer to page A20: 86 for deep hole drilling guidelines in this section of the catalog. Visit [www.alliedmachine.com/DeepHoleGuidelines](http://www.alliedmachine.com/DeepHoleGuidelines) for the most up-to-date information and procedures. Factory technical assistance is available for your specific applications through our Application Engineering Team.

i = Imperial (in)  
 ii = Metric (mm)

Screws sold in multiples of 10



## GEN3SYS XT Drill Inserts

26 Series | Diameter Range: 1.0236" - 1.1416" (26.00mm - 28.99mm)

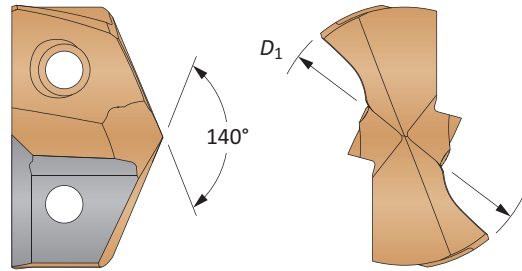
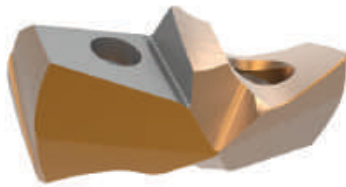

Carbide Substrate	Insert		Standard Part No.	Low Rake Part No.	Cast Iron Part No.	Stainless Part No.	
	Fractional Equivalent	D <sub>1</sub> inch					D <sub>1</sub> mm
C1 (K35)		1.0236	26.00	7C126P-26	7C126P-26LR	-	-
	1-1/32	1.0313	26.20	7C126P-0101	7C126P-0101LR	-	-
	1-3/64	1.0469	26.59	7C126P-1.046	7C126P-1.046LR	-	-
	1-1/16	1.0625	26.99	7C126P-0102	7C126P-0102LR	-	-
		1.0630	27.00	7C126P-27	7C126P-27LR	-	-
	1-3/32	1.0938	27.78	7C126P-0103	7C126P-0103LR	-	-
		1.1024	28.00	7C126P-28	7C126P-28LR	-	-
	1-7/64	1.1094	28.17	7C126P-1.109	7C126P-1.109LR	-	-
	1.1250	28.58	7C126P-0104	7C126P-0104LR	-	-	
C2 (K20)		1.0236	26.00	7C226P-26	7C226P-26LR	7C226P-26CI	7C226P-26AS
	1-1/32	1.0313	26.20	7C226P-0101	7C226P-0101LR	7C226P-0101CI	7C226P-0101AS
	1-3/64	1.0469	26.59	7C226P-1.046	7C226P-1.046LR	7C226P-1.046CI	7C226P-1.046AS
	1-1/16	1.0625	26.99	7C226P-0102	7C226P-0102LR	7C226P-0102CI	7C226P-0102AS
		1.0630	27.00	7C226P-27	7C226P-27LR	7C226P-27CI	7C226P-27AS
	1-3/32	1.0938	27.78	7C226P-0103	7C226P-0103LR	7C226P-0103CI	7C226P-0103AS
		1.1024	28.00	7C226P-28	7C226P-28LR	7C226P-28CI	7C226P-28AS
	1-7/64	1.1094	28.17	7C226P-1.109	7C226P-1.109LR	7C226P-1.109CI	7C226P-1.109AS
	1.1250	28.58	7C226P-0104	7C226P-0104LR	7C226P-0104CI	7C226P-0104AS	

Inserts sold in multiples of 1

A20: 68 - 83

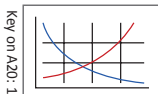

A20: 6 - 9



Sizes not shown are available upon request.  
When ordering, please follow the example below:



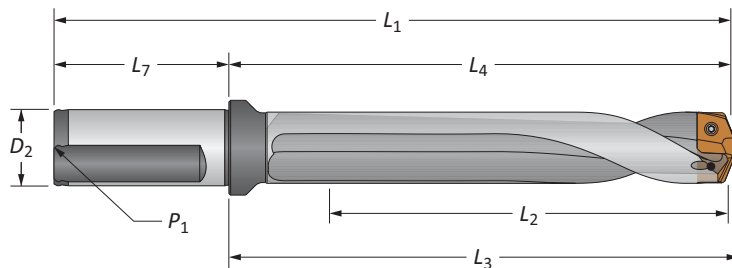

<b>Imperial:</b>	0.5200", 13 series, C2 = use Part No. <b>7C213P-.5200</b>
<b>Metric:</b>	13.20mm, 13 series, C2 = use Part No. <b>7C213P-13.20</b>

## GEN3SYS Drill Insert Holders

26 Series | Diameter Range: 1.0236" - 1.1416" (26.00mm - 28.99mm)





### Straight and Helical

Flute	Length	Body				Shank				Flat	Part No.
		L <sub>2</sub>	L <sub>4</sub>	L <sub>3</sub>	L <sub>1</sub>	L <sub>7</sub>	D <sub>2</sub>	P <sub>1</sub>			
	3xD	3-27/64	5-1/16	5-11/64	7-11/32	2-9/32	1-1/4	1/8	YES	<b>60326S-125F</b>	
	5xD	5-45/64	7-11/32	7-29/64	9-5/8	2-9/32	1-1/4	1/8	YES	<b>60526S-125F</b>	
	7xD	7-63/64	9-5/8	9-47/64	11-29/32	2-9/32	1-1/4	1/8	YES	<b>60726S-125F</b>	
	Stub	1-1/4	2-7/8	2-63/64	5-5/32	2-9/32	1-1/4	1/8	YES	<b>60126H-125F</b>	
	3xD	3-27/64	5-1/16	5-11/64	7-11/32	2-9/32	1-1/4	1/8	YES	<b>60326H-125F</b>	
	3xD	3-27/64	5-1/16	5-11/64	7-11/32	2-9/32	1-1/4	1/8	NO	<b>60326H-125C</b>	
	5xD	5-45/64	7-11/32	7-29/64	9-5/8	2-9/32	1-1/4	1/8	YES	<b>60526H-125F</b>	
	5xD	5-45/64	7-11/32	7-29/64	9-5/8	2-9/32	1-1/4	1/8	NO	<b>60526H-125C</b>	
	7xD	7-63/64	9-5/8	9-47/64	11-29/32	2-9/32	1-1/4	1/8	YES	<b>60726H-125F</b>	
	7xD	7-63/64	9-5/8	9-47/64	11-29/32	2-9/32	1-1/4	1/8	NO	<b>60726H-125C</b>	
	3xD	87.0	128.6	131.4	188.6	60.0	32.0	1/8*	YES	<b>60326S-32FM</b>	
	5xD	145.0	186.5	189.4	246.5	60.0	32.0	1/8*	YES	<b>60526S-32FM</b>	
	7xD	202.9	244.5	247.4	304.5	60.0	32.0	1/8*	YES	<b>60726S-32FM</b>	
	Stub	32.0	72.9	75.7	132.9	60.0	32.0	1/8*	YES	<b>60126H-32FM</b>	
		3xD	87.0	128.6	131.4	188.6	60.0	32.0	1/8*	YES	<b>60326H-32FM</b>
		3xD	87.0	128.6	131.4	188.6	60.0	32.0	1/8*	NO	<b>60326H-32CM</b>
		5xD	145.0	186.5	189.4	246.5	60.0	32.0	1/8*	YES	<b>60526H-32FM</b>
		5xD	145.0	186.5	189.4	246.5	60.0	32.0	1/8*	NO	<b>60526H-32CM</b>
		7xD	202.9	244.5	247.4	304.5	60.0	32.0	1/8*	YES	<b>60726H-32FM</b>
		7xD	202.9	244.5	247.4	304.5	60.0	32.0	1/8*	NO	<b>60726H-32CM</b>

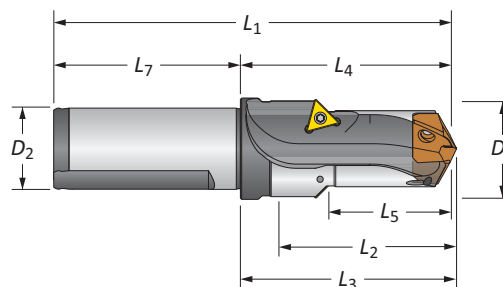



\*Thread to BSP and ISO 7-1



### Drill / Chamfer

Step	Body				Shank			Part No.	 Chamfer Insert	
	D <sub>5</sub>	L <sub>5</sub>	L <sub>2</sub>	L <sub>4</sub>	L <sub>3</sub>	L <sub>1</sub>	L <sub>7</sub>			D <sub>2</sub>
	1-11/32	1-17/32	2-3/64	2-7/8	2-63/64	5-5/32	2-9/32	1-1/4	<b>60126C45-125F</b>	TCMT-110204
	34.0	39.0	52.1	72.9	75.7	132.9	60.0	32.0	<b>60126C45-32FM</b>	TCMT-110204

### Connection Accessories

 Insert Screws	 Nylon Locking Screws	 Insert Driver	 Preset Torque Hand Driver	 Replacement Tips	Admissible Tightening Torque*
7495-IP15-1	7495N-IP15-1	8IP-15	8IP-15TL	8IP-15B	61.0 in-lbs (690 N-cm)

\*Tightening torques are calculated with a friction coefficient of  $\mu = 0.14$  and develop 90% of ultimate yield strength



Chamfer inserts sold separately in multiples of 10 | Screws sold in multiples of 10

 = Imperial (in)  
 = Metric (mm)

**GEN3SYS XT Pro Drill Inserts**

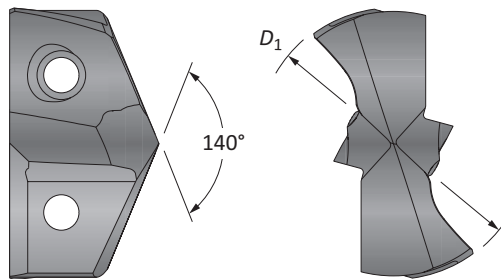
29 Series | Diameter Range: 1.1417" - 1.2597" (29.00mm - 31.99mm)



Fractional Equivalent	Insert				
	D <sub>1</sub> inch	D <sub>1</sub> mm	P	K	N
-	1.1417	29.00	XTP29-29.00	XTK29-29.00	XTN29-29.00
-	1.1457	29.10	XTP29-29.10	XTK29-29.10	XTN29-29.10
-	1.1496	29.20	XTP29-29.20	XTK29-29.20	XTN29-29.20
-	1.1535	29.30	XTP29-29.30	XTK29-29.30	XTN29-29.30
1-5/32	1.1563	29.37	XTP29-29.37	XTK29-29.37	XTN29-29.37
-	1.1575	29.40	XTP29-29.40	XTK29-29.40	XTN29-29.40
-	1.1614	29.50	XTP29-29.50	XTK29-29.50	XTN29-29.50
-	1.1654	29.60	XTP29-29.60	XTK29-29.60	XTN29-29.60
-	1.1693	29.70	XTP29-29.70	XTK29-29.70	XTN29-29.70
-	1.1732	29.80	XTP29-29.80	XTK29-29.80	XTN29-29.80
-	1.1772	29.90	XTP29-29.90	XTK29-29.90	XTN29-29.90
-	1.1811	30.00	XTP29-30.00	XTK29-30.00	XTN29-30.00
-	1.1850	30.10	XTP29-30.10	XTK29-30.10	XTN29-30.10
1-3/16	1.1875	30.16	XTP29-30.16	XTK29-30.16	XTN29-30.16
-	1.1890	30.20	XTP29-30.20	XTK29-30.20	XTN29-30.20
-	1.1929	30.30	XTP29-30.30	XTK29-30.30	XTN29-30.30
-	1.1969	30.40	XTP29-30.40	XTK29-30.40	XTN29-30.40
-	1.2008	30.50	XTP29-30.50	XTK29-30.50	XTN29-30.50
-	1.2047	30.60	XTP29-30.60	XTK29-30.60	XTN29-30.60
-	1.2087	30.70	XTP29-30.70	XTK29-30.70	XTN29-30.70
-	1.2126	30.80	XTP29-30.80	XTK29-30.80	XTN29-30.80
-	1.2165	30.90	XTP29-30.90	XTK29-30.90	XTN29-30.90
1-7/32	1.2188	30.96	XTP29-30.96	XTK29-30.96	XTN29-30.96
-	1.2205	31.00	XTP29-31.00	XTK29-31.00	XTN29-31.00
-	1.2244	31.10	XTP29-31.10	XTK29-31.10	XTN29-31.10
-	1.2283	31.20	XTP29-31.20	XTK29-31.20	XTN29-31.20
-	1.2323	31.30	XTP29-31.30	XTK29-31.30	XTN29-31.30
-	1.2362	31.40	XTP29-31.40	XTK29-31.40	XTN29-31.40
-	1.2402	31.50	XTP29-31.50	XTK29-31.50	XTN29-31.50
-	1.2441	31.60	XTP29-31.60	XTK29-31.60	XTN29-31.60
-	1.2480	31.70	XTP29-31.70	XTK29-31.70	XTN29-31.70
1-1/4	1.2500	31.75	XTP29-31.75	XTK29-31.75	XTN29-31.75
-	1.2520	31.80	XTP29-31.80	XTK29-31.80	XTN29-31.80
-	1.2559	31.90	XTP29-31.90	XTK29-31.90	XTN29-31.90

Inserts sold in multiples of 1

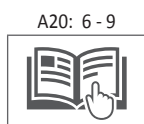
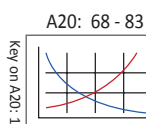



Sizes not shown are available upon request.	
When ordering, please follow the example below:	
<b>Imperial:</b>	0.5180", Steel, 13 series = use Part No. <b>XTP13-13.16</b>
<b>Metric:</b>	13.16mm, Steel, 13 series = use Part No. <b>XTP13-13.16</b>

GEN3SYS XT Pro Drill Insert Holders

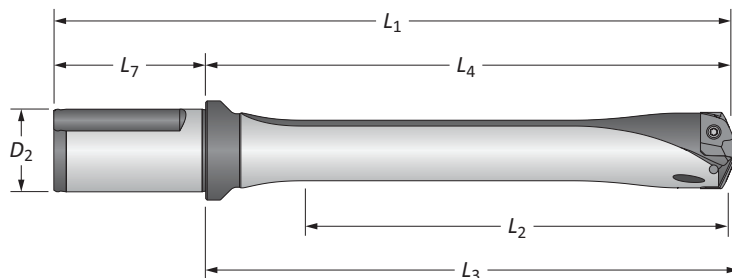
29 Series | Diameter Range: 1.1417" - 1.2597" (29.00mm - 31.99mm)



Flute	Body					Shank			Part No.
	Length	L <sub>2</sub>	L <sub>4</sub>	L <sub>3</sub>	L <sub>1</sub>	L <sub>7</sub>	D <sub>2</sub>	Flat	
i Straight 	3xD	3-25/32	5-3/8	5-1/2	7-21/32	2-9/32	1-1/4	YES	HXT0329S-125F
	3xD	3-25/32	5-3/8	5-1/2	7-21/32	2-9/32	1-1/4	NO	HXT0329S-125C
	5xD	6-19/64	7-29/32	8-1/64	10-3/16	2-9/32	1-1/4	YES	HXT0529S-125F
	5xD	6-19/64	7-29/32	8-1/64	10-3/16	2-9/32	1-1/4	NO	HXT0529S-125C
	7xD	8-13/16	10-27/64	10-17/64	12-45/64	2-9/32	1-1/4	YES	HXT0729S-125F
	7xD	8-13/16	10-27/64	10-17/64	12-45/64	2-9/32	1-1/4	NO	HXT0729S-125C
	10xD	12-19/32	14-3/16	14-5/16	16-15/32	2-9/32	1-1/4	YES	HXT1029S-125F
10xD	12-19/32	14-3/16	14-5/16	16-15/32	2-9/32	1-1/4	NO	HXT1029S-125C	
ii Straight 	3xD	96.0	136.5	139.7	196.5	60.0	32.0	YES	HXT0329S-32FM
	3xD	96.0	136.5	139.7	196.5	60.0	32.0	NO	HXT0329S-32CM
	5xD	160.0	200.8	203.7	260.8	60.0	32.0	YES	HXT0529S-32FM
	5xD	160.0	200.8	203.7	260.8	60.0	32.0	NO	HXT0529S-32CM
	7xD	223.9	264.7	267.6	324.7	60.0	32.0	YES	HXT0729S-32FM
	7xD	223.9	264.7	267.6	324.7	60.0	32.0	NO	HXT0729S-32CM
	10xD	319.9	360.4	363.6	420.4	60.0	32.0	YES	HXT1029S-32FM
	10xD	319.9	360.4	363.6	420.4	60.0	32.0	NO	HXT1029S-32CM

Connection Accessories

Insert Screws	Nylon Locking Screws	Insert Driver	Preset Torque Hand Driver	Replacement Tips	Admissible Tightening Torque*
7495-IP15-1	7495N-IP15-1	8IP-15	8IP-15TL	8IP-15B	61.0 in-lbs (690 N-cm)

\*Tightening torques are calculated with a friction coefficient of  $\mu = 0.14$  and develop 90% of ultimate yield strength

**⚠ WARNING** Refer to Speed and Feed charts for recommended adjustments to speeds and feeds. Refer to page A20: 86 for deep hole drilling guidelines in this section of the catalog. Visit [www.alliedmachine.com/DeepHoleGuidelines](http://www.alliedmachine.com/DeepHoleGuidelines) for the most up-to-date information and procedures. Factory technical assistance is available for your specific applications through our Application Engineering Team.

i = Imperial (in)  
 ii = Metric (mm)

Screws sold in multiples of 10

**GEN3SYS XT Drill Inserts**

29 Series | Diameter Range: 1.1417" - 1.2597" (29.00mm - 31.99mm)

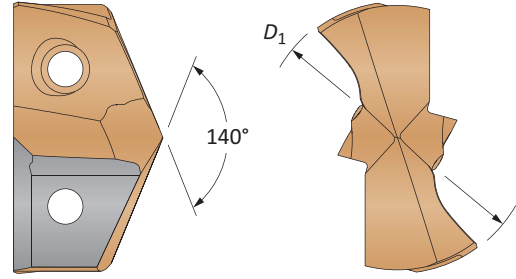
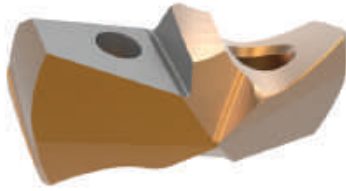

Carbide Substrate	Insert			Standard Part No.	Low Rake Part No.	Cast Iron Part No.	Stainless Part No.
	Fractional Equivalent	D <sub>1</sub> inch	D <sub>1</sub> mm				
C1 (K35)	-	1.1417	29.00	7C129P-29	7C129P-29LR	-	-
	1-5/32	1.1563	29.37	7C129P-0105	7C129P-0105LR	-	-
	-	1.1811	30.00	7C129P-30	7C129P-30LR	-	-
	1-3/16	1.1875	30.16	7C129P-0106	7C129P-0106LR	-	-
	-	1.2008	30.50	7C129P-30.5	7C129P-30.5LR	-	-
	1-7/32	1.2188	30.96	7C129P-0107	7C129P-0107LR	-	-
	-	1.2205	31.00	7C129P-31	7C129P-31LR	-	-
	1-1/4	1.2500	31.75	7C129P-0108	7C129P-0108LR	-	-
C2 (K20)	-	1.1417	29.00	7C229P-29	7C229P-29LR	7C229P-29CI	7C229P-29AS
	1-5/32	1.1563	29.37	7C229P-0105	7C229P-0105LR	7C229P-0105CI	7C229P-0105AS
	-	1.1811	30.00	7C229P-30	7C229P-30LR	7C229P-30CI	7C229P-30AS
	1-3/16	1.1875	30.16	7C229P-0106	7C229P-0106LR	7C229P-0106CI	7C229P-0106AS
	-	1.2008	30.50	7C229P-30.5	7C229P-30.5LR	7C229P-30.5CI	7C229P-30.5AS
	1-7/32	1.2188	30.96	7C229P-0107	7C229P-0107LR	7C229P-0107CI	7C229P-0107AS
	-	1.2205	31.00	7C229P-31	7C229P-31LR	7C229P-31CI	7C229P-31AS
	1-1/4	1.2500	31.75	7C229P-0108	7C229P-0108LR	7C229P-0108CI	7C229P-0108AS

Inserts sold in multiples of 1

A DRILLING

B

BORING

C

REAMING

D

BURNISHING

F

THREADING

X

SPECIALS

A20: 68 - 83

A20: 6 - 9

Sizes not shown are available upon request. When ordering, please follow the example below:	
<b>Imperial:</b>	0.5200", 13 series, C2 = use Part No. <b>7C213P-5200</b>
<b>Metric:</b>	13.20mm, 13 series, C2 = use Part No. <b>7C213P-13.20</b>



**GEN3SYS Drill Insert Holders**

29 Series | Diameter Range: 1.1417" - 1.2597" (29.00mm - 31.99mm)

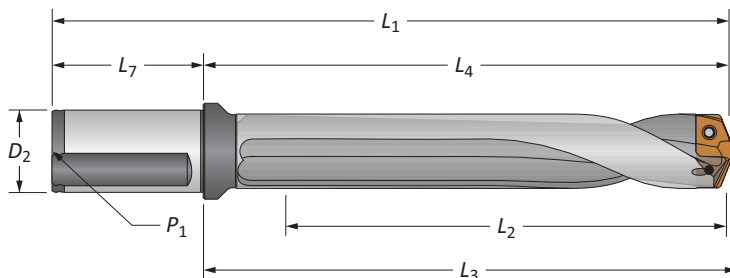

**Straight and Helical**

Flute	Length	Body				Shank				Flat	Part No.
		L <sub>2</sub>	L <sub>4</sub>	L <sub>3</sub>	L <sub>1</sub>	L <sub>7</sub>	D <sub>2</sub>	P <sub>1</sub>			
Straight	3xD	3-25/32	5-3/8	5-1/2	7-21/32	2-9/32	1-1/4	1/4	YES	<b>60329S-125F</b>	
	5xD	6-19/64	7-29/32	8-1/64	10-3/16	2-9/32	1-1/4	1/4	YES	<b>60529S-125F</b>	
	7xD	8-13/16	10-27/64	10-17/64	12-45/64	2-9/32	1-1/4	1/4	YES	<b>60729S-125F</b>	
Helical	Stub	1-3/8	2-31/32	3-5/64	5-1/4	2-9/32	1-1/4	1/4	YES	<b>60129H-125F</b>	
	3xD	3-25/32	5-3/8	5-1/2	7-21/32	2-9/32	1-1/4	1/4	YES	<b>60329H-125F</b>	
	3xD	3-25/32	5-3/8	5-1/2	7-21/32	2-9/32	1-1/4	1/4	NO	<b>60329H-125C</b>	
	5xD	6-19/64	7-29/32	8-1/64	10-3/16	2-9/32	1-1/4	1/4	YES	<b>60529H-125F</b>	
	5xD	6-19/64	7-29/32	8-1/64	10-3/16	2-9/32	1-1/4	1/4	NO	<b>60529H-125C</b>	
	7xD	8-13/16	10-27/64	10-17/64	12-45/64	2-9/32	1-1/4	1/4	YES	<b>60729H-125F</b>	
	7xD	8-13/16	10-27/64	10-17/64	12-45/64	2-9/32	1-1/4	1/4	NO	<b>60729H-125C</b>	
Straight	3xD	96.0	136.5	139.7	196.5	60.0	32.0	1/4*	YES	<b>60329S-32FM</b>	
	5xD	160.0	200.8	203.7	260.8	60.0	32.0	1/4*	YES	<b>60529S-32FM</b>	
	7xD	223.9	264.7	267.6	324.7	60.0	32.0	1/4*	YES	<b>60729S-32FM</b>	
	Stub	35.0	75.2	78.2	135.2	60.0	32.0	1/4*	YES	<b>60129H-32FM</b>	
	Helical	3xD	96.0	136.5	139.7	196.5	60.0	32.0	1/4*	YES	<b>60329H-32FM</b>
		3xD	96.0	136.5	139.7	196.5	60.0	32.0	1/4*	NO	<b>60329H-32CM</b>
		5xD	160.0	200.8	203.7	260.8	60.0	32.0	1/4*	YES	<b>60529H-32FM</b>
		5xD	160.0	200.8	203.7	260.8	60.0	32.0	1/4*	NO	<b>60529H-32CM</b>
		7xD	223.9	264.7	267.6	324.7	60.0	32.0	1/4*	YES	<b>60729H-32FM</b>
		7xD	223.9	264.7	267.6	324.7	60.0	32.0	1/4*	NO	<b>60729H-32CM</b>

\*Thread to BSP and ISO 7-1

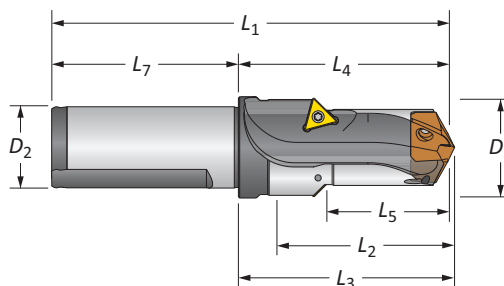

**Drill / Chamfer**

Step	Body				Shank			Part No.	Chamfer Insert
	D <sub>5</sub>	L <sub>5</sub>	L <sub>2</sub>	L <sub>4</sub>	L <sub>3</sub>	L <sub>1</sub>	L <sub>7</sub>		
1-29/64	1-23/32	2-13/64	2-31/32	3-5/64	5-1/4	2-9/32	1-1/4	<b>60129C45-125F</b>	TCMT-16T304
37.1	43.5	55.9	75.2	78.2	135.2	60.0	32.0	<b>60129C45-32FM</b>	TCMT-16T304

**Connection Accessories**

Insert Screws	Nylon Locking Screws	Insert Driver	Preset Torque Hand Driver	Replacement Tips	Admissible Tightening Torque*
7495-IP15-1	7495N-IP15-1	8IP-15	8IP-15TL	8IP-15B	61.0 in-lbs (690 N-cm)

\*Tightening torques are calculated with a friction coefficient of  $\mu = 0.14$  and develop 90% of ultimate yield strength



Chamfer inserts sold separately in multiples of 10 | Screws sold in multiples of 10

= Imperial (in)  
 = Metric (mm)

GEN3SYS XT Pro Drill Inserts

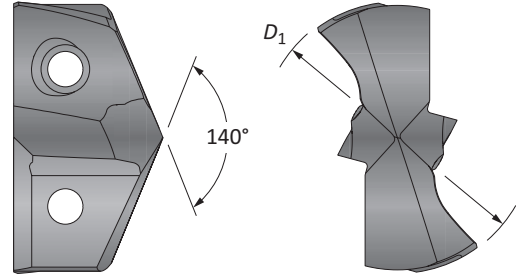
32 Series | Diameter Range: 1.2598" - 1.3780" (32.00mm - 35.00mm)



Fractional Equivalent	Insert				
	D <sub>1</sub> inch	D <sub>1</sub> mm	Part No. P	Part No. K	Part No. N
-	1.2598	32.00	XTP32-32.00	XTK32-32.00	XTN32-32.00
-	1.2638	32.10	XTP32-32.10	XTK32-32.10	XTN32-32.10
1-17/64	1.2657	32.15	XTP32-32.15	XTK32-32.15	XTN32-32.15
-	1.2677	32.20	XTP32-32.20	XTK32-32.20	XTN32-32.20
-	1.2717	32.30	XTP32-32.30	XTK32-32.30	XTN32-32.30
-	1.2756	32.40	XTP32-32.40	XTK32-32.40	XTN32-32.40
-	1.2795	32.50	XTP32-32.50	XTK32-32.50	XTN32-32.50
1-9/32	1.2813	32.55	XTP32-32.55	XTK32-32.55	XTN32-32.55
-	1.2835	32.60	XTP32-32.60	XTK32-32.60	XTN32-32.60
-	1.2874	32.70	XTP32-32.70	XTK32-32.70	XTN32-32.70
-	1.2913	32.80	XTP32-32.80	XTK32-32.80	XTN32-32.80
-	1.2953	32.90	XTP32-32.90	XTK32-32.90	XTN32-32.90
-	1.2992	33.00	XTP32-33.00	XTK32-33.00	XTN32-33.00
-	1.3031	33.10	XTP32-33.10	XTK32-33.10	XTN32-33.10
-	1.3071	33.20	XTP32-33.20	XTK32-33.20	XTN32-33.20
-	1.3110	33.30	XTP32-33.30	XTK32-33.30	XTN32-33.30
1-5/16	1.3125	33.34	XTP32-33.34	XTK32-33.34	XTN32-33.34
-	1.3150	33.40	XTP32-33.40	XTK32-33.40	XTN32-33.40
-	1.3189	33.50	XTP32-33.50	XTK32-33.50	XTN32-33.50
-	1.3228	33.60	XTP32-33.60	XTK32-33.60	XTN32-33.60
-	1.3268	33.70	XTP32-33.70	XTK32-33.70	XTN32-33.70
-	1.3307	33.80	XTP32-33.80	XTK32-33.80	XTN32-33.80
-	1.3346	33.90	XTP32-33.90	XTK32-33.90	XTN32-33.90
-	1.3386	34.00	XTP32-34.00	XTK32-34.00	XTN32-34.00
-	1.3425	34.10	XTP32-34.10	XTK32-34.10	XTN32-34.10
1-11/32	1.3438	34.13	XTP32-34.13	XTK32-34.13	XTN32-34.13
-	1.3465	34.20	XTP32-34.20	XTK32-34.20	XTN32-34.20
-	1.3504	34.30	XTP32-34.30	XTK32-34.30	XTN32-34.30
-	1.3543	34.40	XTP32-34.40	XTK32-34.40	XTN32-34.40
-	1.3583	34.50	XTP32-34.50	XTK32-34.50	XTN32-34.50
-	1.3622	34.60	XTP32-34.60	XTK32-34.60	XTN32-34.60
-	1.3661	34.70	XTP32-34.70	XTK32-34.70	XTN32-34.70
-	1.3701	34.80	XTP32-34.80	XTK32-34.80	XTN32-34.80
-	1.3740	34.90	XTP32-34.90	XTK32-34.90	XTN32-34.90
1-3/8	1.3750	34.93	XTP32-34.93	XTK32-34.93	XTN32-34.93
-	1.3780	35.00	XTP32-35.00	XTK32-35.00	XTN32-35.00

Inserts sold in multiples of 1

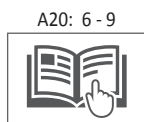
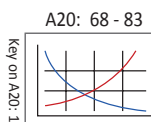

Sizes not shown are available upon request.	
When ordering, please follow the example below:	
<b>Imperial:</b>	0.5180", Steel, 13 series = use Part No. XTP13-13.16
<b>Metric:</b>	13.16mm, Steel, 13 series = use Part No. XTP13-13.16

**GEN3SYS XT Pro Drill Insert Holders**

32 Series | Diameter Range: 1.2598" - 1.3780" (32.00mm - 35.00mm)

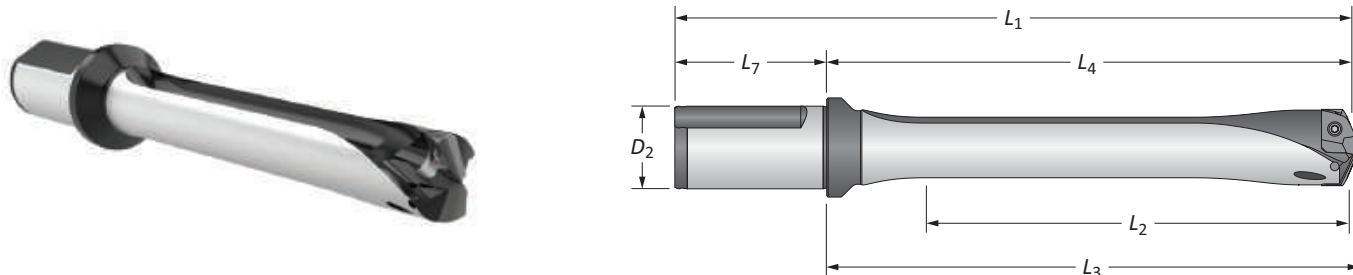

Flute	Body					Shank			Part No.
	Length	L <sub>2</sub>	L <sub>4</sub>	L <sub>3</sub>	L <sub>1</sub>	L <sub>7</sub>	D <sub>2</sub>	Flat	
i Straight	3xD	4-9/64	6-7/32	6-23/64	8-29/32	2-11/16	1-1/2	YES	HXT0332S-150F
	3xD	4-9/64	6-7/32	6-23/64	8-29/32	2-11/16	1-1/2	NO	HXT0332S-150C
	5xD	6-57/64	8-31/32	9-7/64	11-21/32	2-11/16	1-1/2	YES	HXT0532S-150F
	5xD	6-57/64	8-31/32	9-7/64	11-21/32	2-11/16	1-1/2	NO	HXT0532S-150C
	7xD	9-41/64	11-23/32	11-55/64	14-13/32	2-11/16	1-1/2	YES	HXT0732S-150F
	7xD	9-41/64	11-23/32	11-55/64	14-13/32	2-11/16	1-1/2	NO	HXT0732S-150C
	10xD	13-25/32	15-55/64	16	18-35/64	2-11/16	1-1/2	YES	HXT1032S-150F
10xD	13-25/32	15-55/64	16	18-35/64	2-11/16	1-1/2	NO	HXT1032S-150C	
ii Straight	3xD	105.0	150.7	154.3	210.7	60.0	32.0	YES	HXT0332S-32FM
	3xD	105.0	150.7	154.3	210.7	60.0	32.0	NO	HXT0332S-32CM
	5xD	175.0	220.7	224.3	280.7	60.0	32.0	YES	HXT0532S-32FM
	5xD	175.0	220.7	224.3	280.7	60.0	32.0	NO	HXT0532S-32CM
	7xD	245.0	290.7	294.3	350.7	60.0	32.0	YES	HXT0732S-32FM
	7xD	245.0	290.7	294.3	350.7	60.0	32.0	NO	HXT0732S-32CM
	10xD	350.0	395.7	399.3	455.7	60.0	32.0	YES	HXT1032S-32FM
	10xD	350.0	395.7	399.3	455.7	60.0	32.0	NO	HXT1032S-32CM

**Connection Accessories**

					<b>Admissible Tightening Torque*</b>
7495-IP15-1	7495N-IP15-1	8IP-15	8IP-15TL	8IP-15B	61.0 in-lbs (690 N-cm)

\*Tightening torques are calculated with a friction coefficient of  $\mu = 0.14$  and develop 90% of ultimate yield strength

**⚠ WARNING** Refer to Speed and Feed charts for recommended adjustments to speeds and feeds. Refer to page A20: 86 for deep hole drilling guidelines in this section of the catalog. Visit [www.alliedmachine.com/DeepHoleGuidelines](http://www.alliedmachine.com/DeepHoleGuidelines) for the most up-to-date information and procedures. Factory technical assistance is available for your specific applications through our Application Engineering Team.

i = Imperial (in)  
ii = Metric (mm)

Screws sold in multiples of 10

## GEN3SYS XT Drill Inserts

32 Series | Diameter Range: 1.2598" - 1.3780" (32.00mm - 35.00mm)

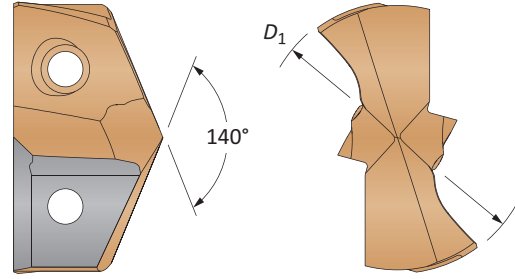

Carbide Substrate	Insert			Standard Part No.	Low Rake Part No.	Cast Iron Part No.	Stainless Part No.
	Fractional Equivalent	D <sub>1</sub> inch	D <sub>1</sub> mm				
C1 (K35)	-	1.2598	32.00	<b>7C132P-32</b>	<b>7C132P-32LR</b>	-	-
	1-17/64	1.2658	32.15	<b>7C132P-32.15</b>	<b>7C132P-32.15LR</b>	-	-
	-	1.2795	32.50	<b>7C132P-32.5</b>	<b>7C132P-32.5LR</b>	-	-
	1-9/32	1.2813	32.55	<b>7C132P-0109</b>	<b>7C132P-0109LR</b>	-	-
	-	1.2992	33.00	<b>7C132P-33</b>	<b>7C132P-33LR</b>	-	-
	1-5/16	1.3125	33.34	<b>7C132P-0110</b>	<b>7C132P-0110LR</b>	-	-
	-	1.3189	33.50	<b>7C132P-33.5</b>	<b>7C132P-33.5LR</b>	-	-
	-	1.3386	34.00	<b>7C132P-34</b>	<b>7C132P-34LR</b>	-	-
	1-11/32	1.3438	34.13	<b>7C132P-0111</b>	<b>7C132P-0111LR</b>	-	-
	-	1.3583	34.50	<b>7C132P-34.5</b>	<b>7C132P-34.5LR</b>	-	-
1-3/8	1.3750	34.93	<b>7C132P-0112</b>	<b>7C132P-0112LR</b>	-	-	
-	1.3780	35.00	<b>7C132P-35</b>	<b>7C132P-35LR</b>	-	-	
C2 (K20)	-	1.2598	32.00	<b>7C232P-32</b>	<b>7C232P-32LR</b>	<b>7C232P-32CI</b>	<b>7C232P-32AS</b>
	1-17/64	1.2658	32.15	<b>7C232P-32.15</b>	<b>7C232P-32.15LR</b>	<b>7C232P-32.15CI</b>	<b>7C232P-32.15AS</b>
	-	1.2795	32.50	<b>7C232P-32.5</b>	<b>7C232P-32.5LR</b>	<b>7C232P-32.5CI</b>	<b>7C232P-32.5AS</b>
	1-9/32	1.2813	32.55	<b>7C232P-0109</b>	<b>7C232P-0109LR</b>	<b>7C232P-0109CI</b>	<b>7C232P-0109AS</b>
	-	1.2992	33.00	<b>7C232P-33</b>	<b>7C232P-33LR</b>	<b>7C232P-33CI</b>	<b>7C232P-33AS</b>
	1-5/16	1.3125	33.34	<b>7C232P-0110</b>	<b>7C232P-0110LR</b>	<b>7C232P-0110CI</b>	<b>7C232P-0110AS</b>
	-	1.3189	33.50	<b>7C232P-33.5</b>	<b>7C232P-33.5LR</b>	<b>7C232P-33.5CI</b>	<b>7C232P-33.5AS</b>
	-	1.3386	34.00	<b>7C232P-34</b>	<b>7C232P-34LR</b>	<b>7C232P-34CI</b>	<b>7C232P-34AS</b>
	1-11/32	1.3438	34.13	<b>7C232P-0111</b>	<b>7C232P-0111LR</b>	<b>7C232P-0111CI</b>	<b>7C232P-0111AS</b>
	-	1.3583	34.50	<b>7C232P-34.5</b>	<b>7C232P-34.5LR</b>	<b>7C232P-34.5CI</b>	<b>7C232P-34.5AS</b>
1-3/8	1.3750	34.93	<b>7C232P-0112</b>	<b>7C232P-0112LR</b>	<b>7C232P-0112CI</b>	<b>7C232P-0112AS</b>	
-	1.3780	35.00	<b>7C232P-35</b>	<b>7C232P-35LR</b>	<b>7C232P-35CI</b>	<b>7C232P-35AS</b>	

Inserts sold in multiples of 1

A20: 68 - 83

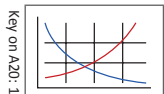

A20: 6 - 9



Sizes not shown are available upon request.  
When ordering, please follow the example below:

<b>Imperial:</b>	0.5200", 13 series, C2 = use Part No. <b>7C213P-.5200</b>
<b>Metric:</b>	13.20mm, 13 series, C2 = use Part No. <b>7C213P-13.20</b>



## GEN3SYS Drill Insert Holders

32 Series | Diameter Range: 1.2598" - 1.3780" (32.00mm - 35.00mm)

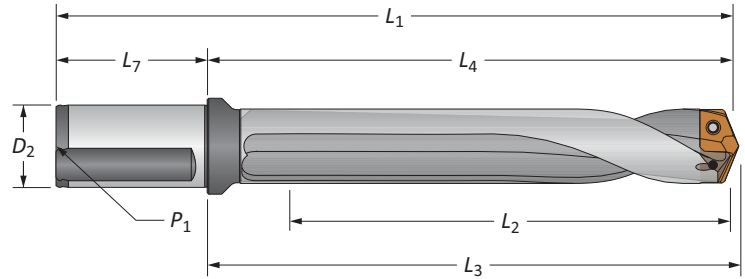

### Straight and Helical

Flute	Length	Body				Shank				Flat	Part No.
		L <sub>2</sub>	L <sub>4</sub>	L <sub>3</sub>	L <sub>1</sub>	L <sub>7</sub>	D <sub>2</sub>	P <sub>1</sub>			
Straight	3xD	4-9/64	6-7/32	6-23/64	8-29/32	2-11/16	1-1/2	1/4	YES	<b>60332S-150F</b>	
	5xD	6-57/64	8-31/32	9-7/64	11-21/32	2-11/16	1-1/2	1/4	YES	<b>60532S-150F</b>	
	7xD	9-41/64	11-23/32	11-55/64	14-13/32	2-11/16	1-1/2	1/4	YES	<b>60732S-150F</b>	
Helical	Stub	1-1/2	3-37/64	3-45/64	6-1/4	2-11/16	1-1/2	1/4	YES	<b>60132H-150F</b>	
	3xD	4-9/64	6-7/32	6-23/64	8-29/32	2-11/16	1-1/2	1/4	YES	<b>60332H-150F</b>	
	3xD	4-9/64	6-7/32	6-23/64	8-29/32	2-11/16	1-1/2	1/4	NO	<b>60332H-150C</b>	
	5xD	6-57/64	8-31/32	9-7/64	11-21/32	2-11/16	1-1/2	1/4	YES	<b>60532H-150F</b>	
	5xD	6-57/64	8-31/32	9-7/64	11-21/32	2-11/16	1-1/2	1/4	NO	<b>60532H-150C</b>	
	7xD	9-41/64	11-23/32	11-55/64	14-13/32	2-11/16	1-1/2	1/4	YES	<b>60732H-150F</b>	
	7xD	9-41/64	11-23/32	11-55/64	14-13/32	2-11/16	1-1/2	1/4	NO	<b>60732H-150C</b>	
Straight	3xD	105.0	150.7	154.3	220.7	70.0	40.0	1/4*	YES	<b>60332S-40FM</b>	
	5xD	175.0	220.7	224.3	290.7	70.0	40.0	1/4*	YES	<b>60532S-40FM</b>	
	7xD	245.0	290.7	294.3	360.7	70.0	40.0	1/4*	YES	<b>60732S-40FM</b>	
	Stub	38.0	90.7	94.2	160.7	70.0	40.0	1/4*	YES	<b>60132H-40FM</b>	
	Helical	3xD	105.0	150.7	154.3	220.7	70.0	40.0	1/4*	YES	<b>60332H-40FM</b>
		3xD	105.0	150.7	154.3	220.7	70.0	40.0	1/4*	NO	<b>60332H-40CM</b>
		5xD	175.0	220.7	224.3	290.7	70.0	40.0	1/4*	YES	<b>60532H-40FM</b>
		5xD	175.0	220.7	224.3	290.7	70.0	40.0	1/4*	NO	<b>60532H-40CM</b>
		7xD	245.0	290.7	294.3	360.7	70.0	40.0	1/4*	YES	<b>60732H-40FM</b>
		7xD	245.0	290.7	294.3	360.7	70.0	40.0	1/4*	NO	<b>60732H-40CM</b>

\*Thread to BSP and ISO 7-1

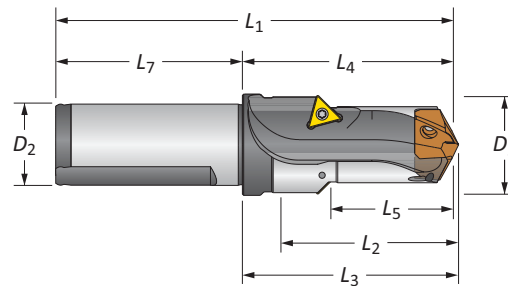

### Drill / Chamfer

Step	Body				Shank			Part No.	Chamfer Insert
	D <sub>5</sub>	L <sub>5</sub>	L <sub>2</sub>	L <sub>4</sub>	L <sub>3</sub>	L <sub>1</sub>	L <sub>7</sub>		
1-37/64	1-57/64	2-29/64	3-37/64	3-23/32	6-1/4	2-11/16	1-1/2	<b>60132C45-150F</b>	TCMT-16T304
40.1	48.0	62.4	90.7	94.2	160.7	70.0	40.0	<b>60132C45-40FM</b>	TCMT-16T304

### Connection Accessories

Insert Screws	Nylon Locking Screws	Insert Driver	Preset Torque Hand Driver	Replacement Tips	Admissible Tightening Torque*
7495-IP15-1	7495N-IP15-1	8IP-15	8IP-15TL	8IP-15B	61.0 in-lbs (690 N-cm)

\*Tightening torques are calculated with a friction coefficient of  $\mu = 0.14$  and develop 90% of ultimate yield strength

Chamfer inserts sold separately in multiples of 10 | Screws sold in multiples of 10

= Imperial (in)  
 = Metric (mm)

A DRILLING  
B BORING  
C REAMING  
D BURNISHING  
E THREADING  
X SPECIALS

## Recommended Drilling Data | Imperial (inch)

### GEN3SYS XT Pro

ISO	Material	Hardness (BHN)	Speed (SFM)	Feed Rate (IPR) by Diameter			
				11 series 0.4331 - 0.4723	12 series 0.4724 - 0.5117	13 series 0.5118 - 0.5511	14 series 0.5512 - 0.5905
P	Free Machining Steel 1118, 1215, 12L14, etc.	100 - 150	550	0.011	0.012	0.013	0.014
		150 - 200	475	0.010	0.011	0.012	0.013
		200 - 250	425	0.008	0.009	0.010	0.011
	Low Carbon Steel 1010, 1020, 1025, 1522, 1144, etc.	85 - 125	520	0.011	0.012	0.013	0.014
		125 - 175	450	0.010	0.011	0.012	0.013
		175 - 225	410	0.009	0.010	0.011	0.012
	Medium Carbon Steel 1030, 1040, 1050, 1527, 1140, 1151, etc.	225 - 275	350	0.007	0.008	0.009	0.010
		125 - 175	450	0.010	0.011	0.012	0.013
		175 - 225	410	0.009	0.010	0.011	0.012
	Alloy Steel 4140, 5140, 8640, etc.	225 - 275	350	0.008	0.009	0.010	0.011
		275 - 325	300	0.007	0.008	0.009	0.010
		125 - 175	415	0.010	0.011	0.012	0.013
		175 - 225	380	0.009	0.010	0.011	0.012
	High Strength Alloy 4340, 4330V, 300M, etc.	225 - 275	340	0.008	0.009	0.010	0.011
		275 - 325	310	0.006	0.007	0.008	0.009
		325 - 375	280	0.006	0.006	0.007	0.008
	Structural Steel A36, A285, A516, etc.	225 - 300	250	0.008	0.009	0.010	0.011
		300 - 350	225	0.006	0.007	0.008	0.009
		350 - 400	200	0.005	0.006	0.007	0.008
	Tool Steel H-13, H-21, A-4, O-2, S-3, etc.	100 - 150	410	0.010	0.011	0.012	0.013
150 - 250		330	0.008	0.009	0.010	0.011	
250 - 350		305	0.007	0.008	0.009	0.010	
S	High Temp Alloy Hastelloy B, Inconel 600, etc.	150 - 200	265	0.006	0.007	0.007	0.008
		200 - 250	205	0.005	0.006	0.006	0.007
	Titanium Alloy	140 - 220	130	0.006	0.007	0.007	0.008
		220 - 310	100	0.005	0.006	0.006	0.007
	Aerospace Alloy S82	140 - 220	140	0.005	0.006	0.007	0.008
220 - 310		110	0.004	0.005	0.006	0.007	
M	Stainless Steel 400 Series 416, 420, etc.	185 - 275	165	0.004	0.004	0.005	0.005
		275 - 350	180	0.005	0.006	0.006	0.007
	Stainless Steel 300 Series 304, 316, 17-4PH, etc.	185 - 275	125	0.003	0.003	0.003	0.004
		135 - 185	220	0.004	0.005	0.005	0.006
	Super Duplex Stainless Steel	135 - 185	125	0.003	0.003	0.003	0.004
		185 - 275	100	0.002	0.002	0.003	0.003

#### 7xD Adjustment Example (0.80 Adjustment)

Data • Adjustment Value	Speed/Feed (7xD)
200 SFM • 0.80	= 160 SFM
0.008 IPR • 0.80	= 0.0064 IPR

#### 10xD Adjustment Example (0.70 Adjustment)

Speed • Adjustment Value	Speed/Feed (10xD)
200 SFM • 0.70	= 140 SFM
0.008 IPR • 0.70	= 0.0056 IPR

#### **⚠ WARNING** Tool failure can cause serious injury. To prevent:

- When using holders without support bushing, use a short GEN3SYS holder to establish an initial hole that is a minimum of 2 diameters deep.
- Do not rotate tool holders more than 50 RPM unless it is engaged with the workpiece or fixture.

Visit [www.alliedmachine.com/DeepHoleGuidelines](http://www.alliedmachine.com/DeepHoleGuidelines) for the most up-to-date information and procedures. Factory technical assistance is available for your specific applications through our Application Engineering Team.

**IMPORTANT:** The speeds and feeds listed above are a general starting point for all applications. Refer to the coolant recommendation charts for coolant requirements to run at the recommended speeds and feeds. Factory technical assistance is available through our Application Engineering department. For 7xD and 10xD holder lengths, see adjustment example above.

A  
DRILLING  
B  
BORING  
C  
REAMING  
D  
BURNISHING  
E  
THREADING  
X  
SPECIALS

Feed Rate (IPR) by Diameter									
15 series 0.5906 - 0.6298	16 series 0.6299 - 0.6692	17 series 0.6693 - 0.7086	18 series 0.7087 - 0.7873	20 series 0.7874 - 0.8660	22 series 0.8661 - 0.9448	24 series 0.9449 - 1.0235	26 series 1.0236 - 1.1416	29 series 1.1417 - 1.2597	32 series 1.2598 - 1.3780
0.015	0.016	0.017	0.019	0.021	0.022	0.023	0.024	0.025	0.026
0.014	0.015	0.016	0.017	0.019	0.020	0.021	0.022	0.023	0.024
0.012	0.013	0.014	0.016	0.018	0.019	0.020	0.021	0.022	0.023
0.015	0.016	0.017	0.019	0.021	0.022	0.023	0.024	0.025	0.026
0.014	0.015	0.016	0.018	0.019	0.020	0.021	0.022	0.023	0.024
0.013	0.014	0.015	0.017	0.018	0.019	0.020	0.021	0.022	0.023
0.011	0.012	0.013	0.015	0.016	0.017	0.018	0.019	0.020	0.021
0.014	0.015	0.016	0.018	0.020	0.021	0.022	0.023	0.024	0.025
0.013	0.014	0.015	0.017	0.019	0.020	0.021	0.022	0.023	0.024
0.012	0.013	0.014	0.016	0.018	0.019	0.020	0.021	0.022	0.023
0.011	0.012	0.013	0.015	0.016	0.017	0.018	0.019	0.020	0.021
0.014	0.015	0.016	0.018	0.020	0.021	0.022	0.023	0.024	0.025
0.013	0.014	0.015	0.017	0.019	0.020	0.021	0.022	0.023	0.024
0.012	0.013	0.014	0.016	0.018	0.019	0.020	0.021	0.022	0.023
0.010	0.011	0.012	0.014	0.015	0.016	0.017	0.018	0.019	0.020
0.009	0.010	0.011	0.013	0.014	0.015	0.016	0.017	0.018	0.019
0.011	0.012	0.013	0.014	0.015	0.016	0.017	0.018	0.019	0.020
0.010	0.011	0.011	0.012	0.013	0.014	0.015	0.016	0.017	0.018
0.009	0.010	0.010	0.011	0.012	0.013	0.014	0.015	0.016	0.017
0.013	0.015	0.015	0.017	0.019	0.021	0.022	0.023	0.024	0.025
0.012	0.013	0.014	0.015	0.017	0.019	0.020	0.021	0.022	0.023
0.011	0.012	0.013	0.014	0.015	0.017	0.019	0.020	0.021	0.022
0.008	0.009	0.009	0.010	0.011	0.012	0.013	0.014	0.015	0.016
0.007	0.008	0.008	0.009	0.010	0.011	0.012	0.013	0.014	0.015
0.008	0.009	0.009	0.010	0.011	0.011	0.012	0.012	0.013	0.014
0.007	0.008	0.008	0.009	0.010	0.010	0.011	0.011	0.012	0.013
0.008	0.009	0.009	0.010	0.011	0.011	0.012	0.012	0.013	0.014
0.007	0.008	0.008	0.009	0.010	0.010	0.011	0.011	0.012	0.012
0.006	0.006	0.007	0.007	0.008	0.008	0.009	0.010	0.011	0.012
0.005	0.006	0.006	0.006	0.007	0.008	0.008	0.009	0.010	0.011
0.008	0.009	0.010	0.011	0.012	0.013	0.014	0.015	0.016	0.017
0.007	0.008	0.009	0.010	0.011	0.012	0.013	0.014	0.015	0.016
0.006	0.007	0.007	0.008	0.008	0.009	0.009	0.010	0.010	0.011
0.005	0.006	0.006	0.007	0.007	0.008	0.008	0.009	0.009	0.010
0.004	0.005	0.005	0.006	0.006	0.007	0.008	0.008	0.008	0.010
0.004	0.004	0.005	0.005	0.006	0.006	0.007	0.007	0.008	0.008

Coolant Recommendations

Series	Stub, 3xD, 5xD		7xD		10xD	
	Pressure PSI	Flow Rate GPM	Pressure PSI	Flow Rate GPM	Pressure PSI	Flow Rate GPM
11	450	5	600	8	800	10
12	450	5	600	8	800	10
13	400	6	500	9.5	750	12
14	400	7	500	9.5	750	12
15	380	7	475	11	700	14
16	380	8	475	12	700	15
17	350	8	450	12.5	650	16.5
18	350	9	450	12.5	650	16.5
20	300	10	400	13	600	18
22	300	11	400	14	600	18
24	300	11	400	14	600	18
26	300	12	400	16	600	20
29	300	12	400	16	600	20
32	300	12	400	16	600	20

## Recommended Drilling Data | Imperial (inch)

### GEN3SYS XT Pro

ISO	Material	Hardness (BHN)	Speed (SFM)	Feed Rate (IPR) by Diameter			
				11 series 0.4331 - 0.4723	12 series 0.4724 - 0.5117	13 series 0.5118 - 0.5511	14 series 0.5512 - 0.5905
H	Wear Plate Hardox, AR400, T-1, etc.	400	160	0.005	0.005	0.006	0.006
		500	130	0.004	0.004	0.005	0.006
		600	90	0.004	0.004	0.004	0.005
	Hardened Steel	300 - 400	170	0.005	0.005	0.006	0.006
400 - 500		130	0.004	0.004	0.005	0.006	
K	SG / Nodular Cast Iron	120 - 150	550	0.010	0.012	0.013	0.014
		150 - 200	520	0.010	0.011	0.012	0.013
		200 - 220	465	0.008	0.010	0.011	0.012
		220 - 260	405	0.008	0.009	0.010	0.011
		260 - 320	365	0.008	0.008	0.009	0.010
	Grey / White Iron	120 - 150	575	0.012	0.013	0.014	0.015
		150 - 200	550	0.011	0.012	0.013	0.014
		200 - 220	495	0.010	0.011	0.012	0.013
		220 - 260	425	0.009	0.010	0.011	0.012
		260 - 320	380	0.009	0.010	0.011	0.012
N	Cast Aluminum	30	1150	0.012	0.013	0.014	0.015
		180	860	0.011	0.012	0.013	0.014
	Wrought Aluminum	30	1600	0.013	0.015	0.016	0.017
		180	1150	0.012	0.014	0.015	0.016
	Aluminum Bronze	100 - 200	415	0.010	0.011	0.012	0.012
		200 - 250	335	0.008	0.009	0.010	0.011
	Brass	100	755	0.010	0.012	0.013	0.014
Copper	60	490	0.003	0.003	0.003	0.004	

#### 7xD Adjustment Example (0.80 Adjustment)

Data • Adjustment Value	Speed/Feed (7xD)
200 SFM • 0.80	= 160 SFM
0.008 IPR • 0.80	= 0.0064 IPR

#### 10xD Adjustment Example (0.70 Adjustment)

Speed • Adjustment Value	Speed/Feed (10xD)
200 SFM • 0.70	= 140 SFM
0.008 IPR • 0.70	= 0.0056 IPR

#### **⚠ WARNING** Tool failure can cause serious injury. To prevent:

- When using holders without support bushing, use a short GEN3SYS holder to establish an initial hole that is a minimum of 2 diameters deep.
- Do not rotate tool holders more than 50 RPM unless it is engaged with the workpiece or fixture.

Visit [www.alliedmachine.com/DeepHoleGuidelines](http://www.alliedmachine.com/DeepHoleGuidelines) for the most up-to-date information and procedures. Factory technical assistance is available for your specific applications through our Application Engineering Team.

**IMPORTANT:** The speeds and feeds listed above are a general starting point for all applications. Refer to the coolant recommendation charts for coolant requirements to run at the recommended speeds and feeds. Factory technical assistance is available through our Application Engineering department. For 7xD and 10xD holder lengths, see adjustment example above.



A  
DRILLING  
B  
BORING  
C  
REAMING  
D  
BURNISHING  
E  
THREADING  
X  
SPECIALS

Feed Rate (IPR) by Diameter									
15 series 0.5906 - 0.6298	16 series 0.6299 - 0.6692	17 series 0.6693 - 0.7086	18 series 0.7087 - 0.7873	20 series 0.7874 - 0.8660	22 series 0.8661 - 0.9448	24 series 0.9449 - 1.0235	26 series 1.0236 - 1.1416	29 series 1.1417 - 1.2597	32 series 1.2598 - 1.3780
0.007	0.008	0.009	0.010	0.010	0.010	0.011	0.011	0.012	0.012
0.006	0.007	0.008	0.009	0.010	0.010	0.010	0.010	0.011	0.011
0.006	0.006	0.007	0.008	0.009	0.009	0.010	0.010	0.010	0.010
0.007	0.008	0.008	0.009	0.010	0.010	0.010	0.010	0.011	0.011
0.006	0.007	0.008	0.008	0.009	0.009	0.010	0.010	0.010	0.010
0.015	0.016	0.018	0.020	0.020	0.022	0.022	0.024	0.025	0.026
0.014	0.015	0.017	0.019	0.020	0.020	0.022	0.022	0.024	0.024
0.013	0.014	0.016	0.018	0.019	0.020	0.020	0.022	0.022	0.023
0.012	0.013	0.015	0.017	0.018	0.019	0.020	0.020	0.022	0.022
0.011	0.012	0.014	0.015	0.017	0.018	0.019	0.020	0.020	0.021
0.016	0.017	0.019	0.021	0.022	0.023	0.024	0.025	0.026	0.027
0.015	0.016	0.018	0.020	0.021	0.022	0.023	0.024	0.025	0.026
0.014	0.015	0.017	0.020	0.020	0.021	0.022	0.023	0.024	0.025
0.013	0.014	0.016	0.018	0.019	0.020	0.021	0.022	0.023	0.024
0.013	0.014	0.015	0.017	0.018	0.019	0.020	0.021	0.022	0.023
0.016	0.017	0.018	0.019	0.020	0.021	0.022	0.023	0.024	0.025
0.015	0.016	0.017	0.018	0.019	0.020	0.021	0.022	0.023	0.023
0.018	0.019	0.020	0.022	0.023	0.024	0.026	0.027	0.029	0.030
0.017	0.018	0.019	0.021	0.022	0.023	0.025	0.026	0.028	0.029
0.013	0.014	0.015	0.015	0.016	0.017	0.018	0.019	0.019	0.019
0.012	0.012	0.013	0.014	0.015	0.016	0.017	0.018	0.018	0.019
0.015	0.016	0.017	0.019	0.020	0.022	0.023	0.024	0.026	0.026
0.005	0.006	0.006	0.007	0.008	0.008	0.008	0.010	0.010	0.011

**Coolant Recommendations**

Series	Stub, 3xD, 5xD		7xD		10xD	
	Pressure PSI	Flow Rate GPM	Pressure PSI	Flow Rate GPM	Pressure PSI	Flow Rate GPM
11	450	5	600	8	800	10
12	450	5	600	8	800	10
13	400	6	500	9.5	750	12
14	400	7	500	9.5	750	12
15	380	7	475	11	700	14
16	380	8	475	12	700	15
17	350	8	450	12.5	650	16.5
18	350	9	450	12.5	650	16.5
20	300	10	400	13	600	18
22	300	11	400	14	600	18
24	300	11	400	14	600	18
26	300	12	400	16	600	20
29	300	12	400	16	600	20
32	300	12	400	16	600	20

## Recommended Drilling Data | Imperial (inch)

### GEN3SYS XT

ISO	Material	Hardness (BHN)	Speed (SFM)	Feed Rate (IPR) by Diameter			
				11 series 0.4331 - 0.4723	12 series 0.4724 - 0.5117	13 series 0.5118 - 0.5511	14 series 0.5512 - 0.5905
P	Free Machining Steel 1118, 1215, 12L14, etc.	100 - 150	480	0.009	0.011	0.012	0.013
		150 - 200	415	0.009	0.010	0.011	0.012
		200 - 250	390	0.007	0.008	0.009	0.010
	Low Carbon Steel 1010, 1020, 1025, 1522, 1144, etc.	85 - 125	450	0.010	0.011	0.012	0.013
		125 - 175	390	0.009	0.010	0.011	0.012
		175 - 225	355	0.008	0.009	0.010	0.011
	Medium Carbon Steel 1030, 1040, 1050, 1527, 1140, 1151, etc.	225 - 275	310	0.006	0.007	0.008	0.009
		125 - 175	390	0.009	0.010	0.011	0.012
		175 - 225	355	0.008	0.009	0.010	0.011
	Alloy Steel 4140, 5140, 8640, etc.	225 - 275	310	0.007	0.008	0.009	0.010
		275 - 325	265	0.006	0.007	0.008	0.009
		125 - 175	375	0.009	0.010	0.011	0.012
		175 - 225	345	0.008	0.009	0.010	0.011
	High Strength Alloy 4340, 4330V, 300M, etc.	225 - 275	310	0.007	0.008	0.009	0.010
		275 - 325	285	0.006	0.006	0.007	0.008
		325 - 375	255	0.006	0.006	0.006	0.007
	Structural Steel A36, A285, A516, etc.	100 - 150	355	0.009	0.010	0.011	0.012
		150 - 250	285	0.007	0.008	0.009	0.010
250 - 350		265	0.006	0.007	0.008	0.009	
Tool Steel H-13, H-21, A-4, O-2, S-3, etc.	150 - 200	255	0.006	0.006	0.006	0.007	
	200 - 250	195	0.005	0.006	0.006	0.006	
S	High Temp Alloy Hastelloy B, Inconel 600, etc.	140 - 220	120	0.006	0.006	0.006	0.007
		220 - 310	95	0.005	0.006	0.006	0.006
	Titanium Alloy	140 - 220	140	0.005	0.006	0.006	0.007
		220 - 310	110	0.004	0.005	0.006	0.006
	Aerospace Alloy S82	185 - 275	145	0.004	0.004	0.005	0.005
275 - 350		120	0.003	0.003	0.004	0.005	
M	Stainless Steel 400 Series 416, 420, etc.	185 - 275	240	0.006	0.007	0.007	0.008
		275 - 350	185	0.005	0.006	0.006	0.007
	Stainless Steel 300 Series 304, 316, 17-4PH, etc.	135 - 185	220	0.004	0.005	0.005	0.006
		185 - 275	160	0.003	0.004	0.004	0.005
	Super Duplex Stainless Steel	135 - 185	125	0.003	0.003	0.003	0.004
185 - 275		100	0.002	0.002	0.003	0.003	

#### 7xD Adjustment Example (0.80 Adjustment)

Data • Adjustment Value	Speed/Feed (7xD)
200 SFM • 0.80	= 160 SFM
0.008 IPR • 0.80	= 0.0064 IPR

#### 10xD Adjustment Example (0.70 Adjustment)

Speed • Adjustment Value	Speed/Feed (10xD)
200 SFM • 0.70	= 140 SFM
0.008 IPR • 0.70	= 0.0056 IPR

#### **⚠ WARNING** Tool failure can cause serious injury. To prevent:

- When using holders without support bushing, use a short GEN3SYS holder to establish an initial hole that is a minimum of 2 diameters deep.
- Do not rotate tool holders more than 50 RPM unless it is engaged with the workpiece or fixture.

Visit [www.alliedmachine.com/DeepHoleGuidelines](http://www.alliedmachine.com/DeepHoleGuidelines) for the most up-to-date information and procedures. Factory technical assistance is available for your specific applications through our Application Engineering Team.

**IMPORTANT:** The speeds and feeds listed above are a general starting point for all applications. Refer to the coolant recommendation charts for coolant requirements to run at the recommended speeds and feeds. Factory technical assistance is available through our Application Engineering department. For 7xD and 10xD holder lengths, see adjustment example above.

A  
DRILLING  
B  
BORING  
C  
REAMING  
D  
BURNISHING  
E  
THREADING  
X  
SPECIALS

Feed Rate (IPR) by Diameter									
15 series 0.5906 - 0.6298	16 series 0.6299 - 0.6692	17 series 0.6693 - 0.7086	18 series 0.7087 - 0.7873	20 series 0.7874 - 0.8660	22 series 0.8661 - 0.9448	24 series 0.9449 - 1.0235	26 series 1.0236 - 1.1416	29 series 1.1417 - 1.2597	32 series 1.2598 - 1.3780
0.014	0.015	0.016	0.017	0.019	0.020	0.021	0.022	0.023	0.024
0.013	0.014	0.015	0.016	0.017	0.018	0.019	0.020	0.021	0.022
0.011	0.012	0.013	0.015	0.017	0.017	0.018	0.019	0.020	0.021
0.014	0.015	0.016	0.017	0.019	0.020	0.021	0.022	0.023	0.024
0.013	0.014	0.015	0.016	0.017	0.018	0.019	0.020	0.021	0.022
0.012	0.013	0.014	0.015	0.016	0.017	0.018	0.019	0.020	0.021
0.010	0.011	0.012	0.014	0.015	0.016	0.017	0.017	0.018	0.019
0.013	0.014	0.015	0.017	0.018	0.019	0.020	0.021	0.022	0.023
0.012	0.013	0.014	0.016	0.017	0.018	0.019	0.020	0.021	0.022
0.011	0.012	0.013	0.015	0.016	0.017	0.018	0.019	0.020	0.021
0.010	0.011	0.012	0.014	0.015	0.016	0.017	0.017	0.018	0.019
0.013	0.014	0.015	0.017	0.018	0.019	0.020	0.021	0.022	0.023
0.012	0.013	0.014	0.016	0.017	0.018	0.019	0.020	0.021	0.022
0.011	0.012	0.013	0.015	0.015	0.017	0.018	0.019	0.020	0.021
0.009	0.010	0.011	0.013	0.014	0.015	0.016	0.017	0.018	0.018
0.008	0.009	0.010	0.012	0.013	0.014	0.015	0.016	0.017	0.017
0.010	0.011	0.012	0.013	0.014	0.015	0.016	0.017	0.017	0.018
0.009	0.010	0.010	0.011	0.012	0.013	0.014	0.015	0.016	0.017
0.008	0.009	0.009	0.010	0.011	0.012	0.013	0.014	0.015	0.016
0.012	0.014	0.014	0.016	0.017	0.019	0.020	0.021	0.022	0.023
0.011	0.012	0.013	0.014	0.016	0.017	0.018	0.019	0.020	0.021
0.010	0.011	0.012	0.013	0.014	0.016	0.017	0.018	0.019	0.020
0.007	0.008	0.008	0.009	0.010	0.011	0.012	0.013	0.014	0.015
0.006	0.007	0.007	0.008	0.009	0.010	0.011	0.012	0.013	0.014
0.007	0.008	0.008	0.009	0.010	0.010	0.011	0.011	0.012	0.013
0.006	0.007	0.007	0.008	0.009	0.009	0.010	0.010	0.011	0.012
0.007	0.008	0.008	0.009	0.010	0.010	0.011	0.011	0.012	0.013
0.006	0.007	0.007	0.008	0.009	0.009	0.010	0.010	0.011	0.011
0.006	0.006	0.006	0.006	0.007	0.007	0.008	0.009	0.010	0.011
0.005	0.006	0.006	0.006	0.006	0.007	0.007	0.008	0.009	0.010
0.008	0.009	0.010	0.011	0.012	0.013	0.014	0.015	0.016	0.017
0.007	0.008	0.009	0.010	0.011	0.012	0.013	0.014	0.015	0.016
0.006	0.007	0.007	0.008	0.008	0.009	0.009	0.010	0.010	0.011
0.005	0.006	0.006	0.007	0.007	0.008	0.008	0.009	0.009	0.010
0.004	0.005	0.005	0.006	0.006	0.007	0.008	0.008	0.008	0.010
0.004	0.004	0.005	0.005	0.006	0.006	0.007	0.007	0.008	0.008

**Coolant Recommendations**

Series	Stub, 3xD, 5xD		7xD		10xD	
	Pressure PSI	Flow Rate GPM	Pressure PSI	Flow Rate GPM	Pressure PSI	Flow Rate GPM
11	450	5	600	8	800	10
12	450	5	600	8	800	10
13	400	6	500	9.5	750	12
14	400	7	500	9.5	750	12
15	380	7	475	11	700	14
16	380	8	475	12	700	15
17	350	8	450	12.5	650	16.5
18	350	9	450	12.5	650	16.5
20	300	10	400	13	600	18
22	300	11	400	14	600	18
24	300	11	400	14	600	18
26	300	12	400	16	600	20
29	300	12	400	16	600	20
32	300	12	400	16	600	20

## Recommended Drilling Data | Imperial (inch)

### GEN3SYS XT

ISO	Material	Hardness (BHN)	Speed (SFM)	Feed Rate (IPR) by Diameter			
				11 series 0.4331 - 0.4723	12 series 0.4724 - 0.5117	13 series 0.5118 - 0.5511	14 series 0.5512 - 0.5905
H	Wear Plate Hardox, AR400, T-1, etc.	400	145	0.005	0.005	0.006	0.006
		500	110	0.004	0.004	0.005	0.006
		600	80	0.004	0.004	0.004	0.005
	Hardened Steel	300 - 400	155	0.005	0.005	0.006	0.006
400 - 500		120	0.004	0.004	0.005	0.006	
K	SG / Nodular Cast Iron	120 - 150	480	0.009	0.011	0.012	0.013
		150 - 200	450	0.009	0.010	0.011	0.012
		200 - 220	400	0.007	0.009	0.010	0.011
		220 - 260	350	0.007	0.008	0.009	0.010
		260 - 320	320	0.007	0.007	0.008	0.009
	Grey / White Iron	120 - 150	500	0.011	0.012	0.013	0.014
		150 - 200	480	0.010	0.011	0.012	0.013
		200 - 220	430	0.009	0.010	0.011	0.012
		220 - 260	370	0.008	0.009	0.010	0.011
		260 - 320	335	0.008	0.009	0.010	0.011
N	Cast Aluminum	30	1000	0.011	0.012	0.013	0.014
		180	750	0.010	0.011	0.012	0.013
	Wrought Aluminum	30	1400	0.012	0.014	0.015	0.016
		180	1000	0.011	0.013	0.014	0.015
	Aluminum Bronze	100 - 200	360	0.009	0.010	0.011	0.011
		200 - 250	295	0.007	0.008	0.009	0.010
	Brass	100	660	0.009	0.011	0.012	0.013
Copper	60	425	0.003	0.003	0.003	0.004	

#### 7xD Adjustment Example (0.80 Adjustment)

Data • Adjustment Value	Speed/Feed (7xD)
200 SFM • 0.80	= 160 SFM
0.008 IPR • 0.80	= 0.0064 IPR

#### 10xD Adjustment Example (0.70 Adjustment)

Speed • Adjustment Value	Speed/Feed (10xD)
200 SFM • 0.70	= 140 SFM
0.008 IPR • 0.70	= 0.0056 IPR

#### **⚠ WARNING** Tool failure can cause serious injury. To prevent:

- When using holders without support bushing, use a short GEN3SYS holder to establish an initial hole that is a minimum of 2 diameters deep.
- Do not rotate tool holders more than 50 RPM unless it is engaged with the workpiece or fixture.

Visit [www.alliedmachine.com/DeepHoleGuidelines](http://www.alliedmachine.com/DeepHoleGuidelines) for the most up-to-date information and procedures. Factory technical assistance is available for your specific applications through our Application Engineering Team.

**IMPORTANT:** The speeds and feeds listed above are a general starting point for all applications. Refer to the coolant recommendation charts for coolant requirements to run at the recommended speeds and feeds. Factory technical assistance is available through our Application Engineering department. For 7xD and 10xD holder lengths, see adjustment example above.

A  
DRILLING  
B  
BORING  
C  
REAMING  
D  
BURNISHING  
E  
THREADING  
X  
SPECIALS

Feed Rate (IPR) by Diameter									
15 series 0.5906 - 0.6298	16 series 0.6299 - 0.6692	17 series 0.6693 - 0.7086	18 series 0.7087 - 0.7873	20 series 0.7874 - 0.8660	22 series 0.8661 - 0.9448	24 series 0.9449 - 1.0235	26 series 1.0236 - 1.1416	29 series 1.1417 - 1.2597	32 series 1.2598 - 1.3780
0.006	0.007	0.008	0.009	0.009	0.009	0.010	0.010	0.011	0.011
0.006	0.006	0.007	0.008	0.009	0.009	0.009	0.009	0.010	0.010
0.006	0.006	0.006	0.007	0.008	0.008	0.009	0.009	0.009	0.009
0.006	0.007	0.007	0.008	0.009	0.009	0.009	0.009	0.010	0.010
0.006	0.006	0.007	0.007	0.008	0.008	0.009	0.009	0.009	0.009
0.014	0.015	0.017	0.018	0.018	0.020	0.020	0.022	0.023	0.024
0.013	0.014	0.016	0.017	0.018	0.018	0.020	0.020	0.022	0.022
0.012	0.013	0.015	0.016	0.017	0.018	0.018	0.020	0.020	0.021
0.011	0.012	0.014	0.015	0.016	0.017	0.018	0.018	0.020	0.020
0.010	0.011	0.013	0.014	0.015	0.016	0.017	0.018	0.018	0.019
0.015	0.016	0.018	0.019	0.020	0.021	0.022	0.023	0.024	0.025
0.014	0.015	0.017	0.018	0.019	0.020	0.021	0.022	0.023	0.024
0.013	0.014	0.016	0.018	0.018	0.019	0.020	0.021	0.022	0.023
0.012	0.013	0.015	0.017	0.017	0.018	0.019	0.020	0.021	0.022
0.012	0.013	0.014	0.016	0.016	0.017	0.018	0.019	0.020	0.021
0.015	0.016	0.017	0.017	0.018	0.019	0.020	0.021	0.022	0.023
0.014	0.015	0.016	0.016	0.017	0.018	0.019	0.020	0.021	0.021
0.017	0.017	0.018	0.020	0.021	0.022	0.024	0.025	0.027	0.028
0.016	0.016	0.017	0.019	0.020	0.021	0.023	0.024	0.026	0.027
0.012	0.013	0.014	0.014	0.015	0.016	0.017	0.017	0.017	0.017
0.011	0.011	0.012	0.013	0.014	0.015	0.016	0.016	0.016	0.016
0.014	0.015	0.016	0.017	0.018	0.020	0.021	0.022	0.024	0.024
0.005	0.006	0.006	0.006	0.007	0.007	0.007	0.009	0.009	0.010

**Coolant Recommendations**

Series	Stub, 3xD, 5xD		7xD		10xD	
	Pressure PSI	Flow Rate GPM	Pressure PSI	Flow Rate GPM	Pressure PSI	Flow Rate GPM
11	450	5	600	8	800	10
12	450	5	600	8	800	10
13	400	6	500	9.5	750	12
14	400	7	500	9.5	750	12
15	380	7	475	11	700	14
16	380	8	475	12	700	15
17	350	8	450	12.5	650	16.5
18	350	9	450	12.5	650	16.5
20	300	10	400	13	600	18
22	300	11	400	14	600	18
24	300	11	400	14	600	18
26	300	12	400	16	600	20
29	300	12	400	16	600	20
32	300	12	400	16	600	20

## Recommended Drilling Data | Metric (mm)

### GEN3SYS XT Pro

ISO	Material	Hardness (BHN)	Speed (M/mm)	Feed Rate (mm/rev) by Diameter			
				11 series 11.00 - 11.99	12 series 12.00 - 12.99	13 series 13.00 - 13.99	14 series 14.00 - 14.99
P	Free Machining Steel 1118, 1215, 12L14, etc.	100 - 150	168	0.28	0.30	0.33	0.36
		150 - 200	145	0.25	0.28	0.30	0.33
		200 - 250	130	0.20	0.23	0.25	0.28
	Low Carbon Steel 1010, 1020, 1025, 1522, 1144, etc.	85 - 125	158	0.28	0.3	0.33	0.36
		125 - 175	137	0.25	0.28	0.30	0.33
		175 - 225	125	0.23	0.25	0.28	0.30
	Medium Carbon Steel 1030, 1040, 1050, 1527, 1140, 1151, etc.	225 - 275	107	0.18	0.20	0.23	0.25
		125 - 175	137	0.25	0.28	0.30	0.33
		175 - 225	125	0.23	0.25	0.28	0.30
	Alloy Steel 4140, 5140, 8640, etc.	225 - 275	107	0.20	0.23	0.25	0.28
		275 - 325	91	0.18	0.20	0.23	0.25
		125 - 175	126	0.25	0.28	0.30	0.33
		175 - 225	116	0.23	0.25	0.28	0.30
	High Strength Alloy 4340, 4330V, 300M, etc.	225 - 275	104	0.20	0.23	0.25	0.28
		275 - 325	94	0.15	0.18	0.20	0.23
		325 - 375	85	0.15	0.15	0.18	0.20
	Structural Steel A36, A285, A516, etc.	300 - 350	69	0.15	0.18	0.20	0.23
		350 - 400	61	0.13	0.18	0.18	0.20
100 - 150		125	0.25	0.28	0.30	0.33	
Tool Steel H-13, H-21, A-4, O-2, S-3, etc.	150 - 250	101	0.20	0.23	0.25	0.28	
	250 - 350	93	0.18	0.20	0.23	0.25	
S	High Temp Alloy Hastelloy B, Inconel 600, etc.	150 - 200	81	0.15	0.18	0.18	0.20
		200 - 250	62	0.13	0.15	0.15	0.18
	Titanium Alloy	140 - 220	40	0.15	0.18	0.18	0.20
		220 - 310	30	0.13	0.15	0.15	0.18
	Aerospace Alloy S82	140 - 220	43	0.13	0.15	0.18	0.20
220 - 310		34	0.10	0.13	0.15	0.18	
M	Stainless Steel 400 Series 416, 420, etc.	185 - 275	50	0.10	0.10	0.12	0.14
		275 - 350	41	0.09	0.09	0.10	0.12
	Stainless Steel 300 Series 304, 316, 17-4PH, etc.	185 - 275	73	0.15	0.18	0.18	0.20
		275 - 350	56	0.13	0.15	0.15	0.18
	Super Duplex Stainless Steel	135 - 185	64	0.10	0.13	0.13	0.15
185 - 275		47	0.08	0.10	0.10	0.13	
		135 - 185	38	0.08	0.08	0.08	0.10
		185 - 275	30	0.05	0.05	0.08	0.08

#### 7xD Adjustment Example (0.80 Adjustment)

Data • Adjustment Value	Speed/Feed (7xD)
61 M/min • 0.80	= 48.8 M/min
0.20 mm/rev • 0.80	= 0.16 mm/rev

#### 10xD Adjustment Example (0.70 Adjustment)

Speed • Adjustment Value	Speed/Feed (10xD)
61 M/min • 0.70	= 42.7 M/min
0.20 mm/rev • 0.70	= 0.14 mm/rev

#### **⚠ WARNING** Tool failure can cause serious injury. To prevent:

- When using holders without support bushing, use a short GEN3SYS holder to establish an initial hole that is a minimum of 2 diameters deep.
- Do not rotate tool holders more than 50 RPM unless it is engaged with the workpiece or fixture.

Visit [www.alliedmachine.com/DeepHoleGuidelines](http://www.alliedmachine.com/DeepHoleGuidelines) for the most up-to-date information and procedures. Factory technical assistance is available for your specific applications through our Application Engineering Team.

**IMPORTANT:** The speeds and feeds listed above are a general starting point for all applications. Refer to the coolant recommendation charts for coolant requirements to run at the recommended speeds and feeds. Factory technical assistance is available through our Application Engineering department. For 7xD and 10xD holder lengths, see adjustment example above.

A  
DRILLING  
B  
BORING  
C  
REAMING  
D  
BURNISHING  
E  
THREADING  
X  
SPECIALS

Feed Rate (mm/rev) by Diameter									
15 series 15.00 - 15.99	16 series 16.00 - 16.99	17 series 17.00 - 17.99	18 series 18.00 - 19.99	20 series 20.00 - 21.99	22 series 22.00 - 23.99	24 series 24.00 - 25.99	26 series 26.00 - 28.99	29 series 29.00 - 31.99	32 series 32.00 - 35.00
0.38	0.41	0.43	0.48	0.53	0.56	0.58	0.61	0.64	0.66
0.36	0.38	0.41	0.43	0.48	0.51	0.53	0.56	0.58	0.61
0.30	0.33	0.36	0.41	0.46	0.48	0.51	0.53	0.56	0.58
0.38	0.41	0.43	0.48	0.53	0.56	0.58	0.61	0.64	0.66
0.36	0.38	0.41	0.46	0.48	0.51	0.53	0.56	0.58	0.61
0.33	0.36	0.38	0.42	0.46	0.48	0.51	0.53	0.56	0.58
0.28	0.30	0.33	0.38	0.41	0.42	0.46	0.48	0.51	0.53
0.36	0.38	0.41	0.46	0.51	0.53	0.56	0.58	0.61	0.64
0.33	0.36	0.38	0.43	0.48	0.51	0.53	0.56	0.58	0.61
0.30	0.33	0.36	0.41	0.46	0.48	0.51	0.53	0.56	0.58
0.28	0.30	0.33	0.38	0.41	0.43	0.46	0.48	0.51	0.53
0.36	0.38	0.41	0.46	0.51	0.53	0.56	0.58	0.61	0.64
0.33	0.36	0.38	0.43	0.48	0.51	0.53	0.56	0.58	0.61
0.30	0.33	0.36	0.41	0.46	0.48	0.51	0.53	0.56	0.58
0.25	0.28	0.30	0.36	0.38	0.41	0.43	0.46	0.48	0.51
0.23	0.25	0.28	0.33	0.36	0.38	0.41	0.43	0.46	0.48
0.28	0.30	0.33	0.36	0.38	0.41	0.43	0.46	0.48	0.51
0.25	0.28	0.28	0.30	0.33	0.36	0.38	0.41	0.43	0.46
0.23	0.25	0.25	0.28	0.30	0.33	0.36	0.38	0.41	0.43
0.33	0.38	0.38	0.43	0.48	0.53	0.56	0.58	0.61	0.64
0.30	0.33	0.36	0.38	0.43	0.48	0.51	0.53	0.56	0.58
0.28	0.30	0.33	0.36	0.38	0.43	0.48	0.51	0.53	0.56
0.20	0.23	0.23	0.25	0.28	0.30	0.33	0.36	0.38	0.41
0.18	0.20	0.20	0.23	0.25	0.28	0.30	0.33	0.36	0.38
0.20	0.23	0.23	0.25	0.28	0.28	0.30	0.30	0.33	0.36
0.18	0.20	0.20	0.23	0.25	0.25	0.28	0.28	0.30	0.33
0.20	0.23	0.23	0.25	0.28	0.28	0.30	0.30	0.33	0.33
0.18	0.20	0.20	0.23	0.25	0.25	0.28	0.28	0.30	0.30
0.15	0.16	0.18	0.18	0.20	0.22	0.24	0.26	0.28	0.31
0.14	0.15	0.16	0.16	0.18	0.20	0.22	0.24	0.26	0.29
0.20	0.23	0.25	0.28	0.30	0.33	0.36	0.38	0.41	0.43
0.18	0.20	0.23	0.25	0.28	0.30	0.33	0.36	0.38	0.41
0.15	0.18	0.18	0.20	0.20	0.23	0.23	0.25	0.25	0.28
0.13	0.15	0.15	0.18	0.18	0.20	0.20	0.23	0.23	0.25
0.10	0.13	0.13	0.15	0.15	0.18	0.20	0.20	0.20	0.25
0.10	0.10	0.13	0.13	0.15	0.15	0.18	0.18	0.20	0.20

**Coolant Recommendations**

Series	Stub, 3xD, 5xD		7xD		10xD	
	Pressure BAR	Flow Rate LPM	Pressure BAR	Flow Rate LPM	Pressure BAR	Flow Rate LPM
11	31	19	41	30	55	38
12	31	19	41	30	55	38
13	28	23	34	36	52	45
14	28	26	34	36	52	45
15	26	26	33	42	48	53
16	26	30	33	45	48	57
17	24	30	31	47	45	62
18	24	34	31	47	45	62
20	21	38	28	49	41	68
22	21	42	28	53	41	68
24	21	42	28	53	41	68
26	21	45	28	61	41	76
29	21	45	28	61	41	76
32	21	45	28	61	41	76

## Recommended Drilling Data | Metric (mm)

### GEN3SYS XT Pro

ISO	Material	Hardness (BHN)	Speed (M/min)	Feed Rate (mm/rev) by Diameter			
				11 series 11.00 - 11.99	12 series 12.00 - 12.99	13 series 13.00 - 13.99	14 series 14.00 - 14.99
H	Wear Plate Hardox, AR400, T-1, etc.	400	50	0.13	0.13	0.15	0.17
		500	40	0.11	0.11	0.13	0.15
		600	27	0.10	0.10	0.11	0.13
	Hardened Steel	300 - 400	51	0.13	0.13	0.15	0.17
400 - 500		40	0.11	0.11	0.13	0.15	
K	SG / Nodular Cast Iron	120 - 150	168	0.27	0.30	0.33	0.36
		150 - 200	159	0.25	0.28	0.30	0.33
		200 - 220	141	0.22	0.25	0.28	0.30
		220 - 260	124	0.20	0.23	0.25	0.28
		260 - 320	112	0.20	0.21	0.23	0.25
	Grey / White Iron	120 - 150	175	0.30	0.33	0.36	0.38
		150 - 200	168	0.28	0.30	0.33	0.36
		200 - 220	151	0.25	0.28	0.30	0.33
220 - 260		130	0.23	0.25	0.28	0.30	
N	Cast Aluminum	30	351	0.30	0.33	0.36	0.38
		180	262	0.28	0.30	0.33	0.36
	Wrought Aluminum	30	488	0.33	0.38	0.41	0.43
		180	351	0.30	0.36	0.38	0.41
	Aluminum Bronze	100 - 200	126	0.26	0.28	0.30	0.32
		200 - 250	103	0.22	0.24	0.26	0.28
	Brass	100	230	0.29	0.30	0.33	0.36
Copper	60	149	0.07	0.08	0.09	0.11	

#### 7xD Adjustment Example (0.80 Adjustment)

Data • Adjustment Value	Speed/Feed (7xD)
61 M/min • 0.80	= 48.8 M/min
0.20 mm/rev • 0.80	= 0.16 mm/rev

#### 10xD Adjustment Example (0.70 Adjustment)

Speed • Adjustment Value	Speed/Feed (10xD)
61 M/min • 0.70	= 42.7 M/min
0.20 mm/rev • 0.70	= 0.14 mm/rev

#### **⚠ WARNING** Tool failure can cause serious injury. To prevent:

- When using holders without support bushing, use a short GEN3SYS holder to establish an initial hole that is a minimum of 2 diameters deep.
- Do not rotate tool holders more than 50 RPM unless it is engaged with the workpiece or fixture.

Visit [www.alliedmachine.com/DeepHoleGuidelines](http://www.alliedmachine.com/DeepHoleGuidelines) for the most up-to-date information and procedures. Factory technical assistance is available for your specific applications through our Application Engineering Team.

**IMPORTANT:** The speeds and feeds listed above are a general starting point for all applications. Refer to the coolant recommendation charts for coolant requirements to run at the recommended speeds and feeds. Factory technical assistance is available through our Application Engineering department. For 7xD and 10xD holder lengths, see adjustment example above.



A  
DRILLING  
B  
BORING  
C  
REAMING  
D  
BURNISHING  
E  
THREADING  
X  
SPECIALS

Feed Rate (mm/rev) by Diameter									
15 series 15.00 - 15.99	16 series 16.00 - 16.99	17 series 17.00 - 17.99	18 series 18.00 - 19.99	20 series 20.00 - 21.99	22 series 22.00 - 23.99	24 series 24.00 - 25.99	26 series 26.00 - 28.99	29 series 29.00 - 31.99	32 series 32.00 - 35.00
0.19	0.21	0.23	0.25	0.27	0.27	0.29	0.29	0.31	0.31
0.17	0.19	0.21	0.23	0.25	0.25	0.27	0.27	0.29	0.29
0.15	0.17	0.19	0.21	0.23	0.23	0.25	0.25	0.25	0.27
0.19	0.21	0.22	0.23	0.25	0.25	0.27	0.27	0.29	0.29
0.17	0.19	0.20	0.21	0.23	0.23	0.25	0.25	0.27	0.27
0.38	0.41	0.46	0.51	0.53	0.56	0.58	0.61	0.64	0.66
0.36	0.38	0.43	0.48	0.51	0.53	0.56	0.58	0.61	0.63
0.33	0.36	0.41	0.46	0.48	0.51	0.53	0.56	0.58	0.60
0.30	0.33	0.38	0.43	0.46	0.48	0.51	0.53	0.56	0.58
0.28	0.30	0.36	0.38	0.43	0.46	0.48	0.51	0.53	0.55
0.41	0.43	0.48	0.53	0.56	0.58	0.61	0.64	0.66	0.69
0.38	0.41	0.46	0.51	0.53	0.56	0.58	0.61	0.64	0.66
0.36	0.38	0.43	0.51	0.51	0.53	0.56	0.58	0.61	0.64
0.33	0.36	0.41	0.46	0.48	0.51	0.53	0.56	0.58	0.61
0.33	0.36	0.38	0.43	0.46	0.48	0.51	0.53	0.56	0.58
0.41	0.43	0.46	0.48	0.51	0.53	0.56	0.58	0.61	0.64
0.38	0.41	0.43	0.46	0.48	0.51	0.53	0.56	0.58	0.58
0.46	0.48	0.51	0.53	0.56	0.61	0.66	0.69	0.74	0.76
0.43	0.46	0.48	0.53	0.56	0.58	0.64	0.66	0.71	0.74
0.34	0.36	0.38	0.40	0.42	0.44	0.46	0.48	0.48	0.50
0.30	0.32	0.34	0.36	0.38	0.42	0.46	0.46	0.46	0.48
0.38	0.41	0.43	0.48	0.53	0.56	0.60	0.63	0.66	0.66
0.13	0.15	0.16	0.18	0.20	0.20	0.22	0.25	0.25	0.28

Coolant Recommendations

Series	Stub, 3xD, 5xD		7xD		10xD	
	Pressure BAR	Flow Rate LPM	Pressure BAR	Flow Rate LPM	Pressure BAR	Flow Rate LPM
11	31	19	41	30	55	38
12	31	19	41	30	55	38
13	28	23	34	36	52	45
14	28	26	34	36	52	45
15	26	26	33	42	48	53
16	26	30	33	45	48	57
17	24	30	31	47	45	62
18	24	34	31	47	45	62
20	21	38	28	49	41	68
22	21	42	28	53	41	68
24	21	42	28	53	41	68
26	21	45	28	61	41	76
29	21	45	28	61	41	76
32	21	45	28	61	41	76

## Recommended Drilling Data | Metric (mm)

### GEN3SYS XT

ISO	Material	Hardness (BHN)	Speed (M/mm)	Feed Rate (mm/rev) by Diameter			
				11 series 11.00 - 11.99	12 series 12.00 - 12.99	13 series 13.00 - 13.99	14 series 14.00 - 14.99
P	Free Machining Steel 1118, 1215, 12L14, etc.	100 - 150	146	0.23	0.28	0.30	0.33
		150 - 200	126	0.23	0.26	0.28	0.30
		200 - 250	119	0.19	0.21	0.23	0.26
	Low Carbon Steel 1010, 1020, 1025, 1522, 1144, etc.	85 - 125	137	0.26	0.28	0.30	0.33
		125 - 175	119	0.23	0.26	0.28	0.30
		175 - 225	108	0.21	0.23	0.26	0.28
	Medium Carbon Steel 1030, 1040, 1050, 1527, 1140, 1151, etc.	225 - 275	95	0.16	0.19	0.21	0.23
		125 - 175	119	0.23	0.26	0.28	0.30
		175 - 225	108	0.21	0.23	0.26	0.28
	Alloy Steel 4140, 5140, 8640, etc.	225 - 275	95	0.19	0.21	0.23	0.26
		275 - 325	81	0.16	0.19	0.21	0.23
		125 - 175	114	0.23	0.26	0.28	0.30
		175 - 225	105	0.21	0.23	0.26	0.28
	High Strength Alloy 4340, 4330V, 300M, etc.	225 - 275	95	0.19	0.21	0.23	0.26
		275 - 325	87	0.14	0.16	0.19	0.21
		325 - 375	78	0.14	0.14	0.16	0.19
	Structural Steel A36, A285, A516, etc.	300 - 350	63	0.14	0.16	0.19	0.21
		100 - 150	108	0.23	0.26	0.28	0.30
150 - 250		87	0.19	0.21	0.23	0.26	
Tool Steel H-13, H-21, A-4, O-2, S-3, etc.	250 - 350	81	0.16	0.19	0.21	0.23	
	150 - 200	78	0.14	0.16	0.16	0.19	
S	High Temp Alloy Hastelloy B, Inconel 600, etc.	200 - 250	59	0.12	0.14	0.14	0.16
		140 - 220	37	0.14	0.16	0.16	0.19
	Titanium Alloy	220 - 310	29	0.12	0.14	0.14	0.16
		140 - 220	42	0.12	0.14	0.16	0.19
	Aerospace Alloy S82	220 - 310	33	0.09	0.12	0.14	0.16
185 - 275		45	0.09	0.09	0.12	0.12	
M	Stainless Steel 400 Series 416, 420, etc.	275 - 350	56	0.13	0.15	0.15	0.18
		185 - 275	73	0.15	0.18	0.18	0.20
	Stainless Steel 300 Series 304, 316, 17-4PH, etc.	135 - 185	64	0.10	0.13	0.13	0.15
		185 - 275	47	0.08	0.10	0.10	0.13
	Super Duplex Stainless Steel	135 - 185	38	0.08	0.08	0.08	0.10
		185 - 275	30	0.05	0.05	0.08	0.08

#### 7xD Adjustment Example (0.80 Adjustment)

Data • Adjustment Value	Speed/Feed (7xD)
61 M/min • 0.80	= 48.8 M/min
0.20 mm/rev • 0.80	= 0.16 mm/rev

#### 10xD Adjustment Example (0.70 Adjustment)

Speed • Adjustment Value	Speed/Feed (10xD)
61 M/min • 0.70	= 42.7 M/min
0.20 mm/rev • 0.70	= 0.14 mm/rev

#### **⚠ WARNING** Tool failure can cause serious injury. To prevent:

- When using holders without support bushing, use a short GEN3SYS holder to establish an initial hole that is a minimum of 2 diameters deep.
- Do not rotate tool holders more than 50 RPM unless it is engaged with the workpiece or fixture.

Visit [www.alliedmachine.com/DeepHoleGuidelines](http://www.alliedmachine.com/DeepHoleGuidelines) for the most up-to-date information and procedures. Factory technical assistance is available for your specific applications through our Application Engineering Team.

**IMPORTANT:** The speeds and feeds listed above are a general starting point for all applications. Refer to the coolant recommendation charts for coolant requirements to run at the recommended speeds and feeds. Factory technical assistance is available through our Application Engineering department. For 7xD and 10xD holder lengths, see adjustment example above.

A  
DRILLING  
B  
BORING  
C  
REAMING  
D  
BURNISHING  
E  
THREADING  
X  
SPECIALS

Feed Rate (mm/rev) by Diameter									
15 series 15.00 - 15.99	16 series 16.00 - 16.99	17 series 17.00 - 17.99	18 series 18.00 - 19.99	20 series 20.00 - 21.99	22 series 22.00 - 23.99	24 series 24.00 - 25.99	26 series 26.00 - 28.99	29 series 29.00 - 31.99	32 series 32.00 - 35.00
0.35	0.37	0.40	0.44	0.49	0.51	0.54	0.56	0.58	0.61
0.33	0.35	0.37	0.40	0.44	0.47	0.49	0.51	0.54	0.56
0.28	0.30	0.33	0.37	0.42	0.44	0.47	0.49	0.51	0.54
0.35	0.37	0.40	0.44	0.49	0.51	0.54	0.56	0.58	0.61
0.33	0.35	0.37	0.41	0.44	0.47	0.49	0.51	0.54	0.56
0.30	0.33	0.35	0.38	0.41	0.44	0.47	0.49	0.51	0.54
0.26	0.28	0.30	0.35	0.37	0.40	0.42	0.44	0.47	0.49
0.33	0.35	0.37	0.42	0.47	0.49	0.51	0.54	0.56	0.58
0.30	0.33	0.35	0.40	0.44	0.47	0.49	0.51	0.54	0.56
0.28	0.30	0.33	0.37	0.41	0.44	0.47	0.49	0.51	0.54
0.26	0.28	0.30	0.35	0.37	0.40	0.42	0.44	0.47	0.49
0.33	0.35	0.37	0.42	0.47	0.49	0.51	0.54	0.56	0.58
0.30	0.33	0.35	0.40	0.44	0.47	0.49	0.51	0.54	0.56
0.28	0.30	0.33	0.37	0.38	0.44	0.47	0.49	0.51	0.54
0.23	0.26	0.28	0.33	0.35	0.37	0.40	0.42	0.46	0.47
0.21	0.23	0.26	0.30	0.33	0.35	0.37	0.40	0.42	0.44
0.26	0.28	0.30	0.33	0.35	0.37	0.40	0.42	0.44	0.47
0.23	0.26	0.26	0.28	0.30	0.33	0.35	0.37	0.40	0.42
0.21	0.23	0.23	0.26	0.28	0.30	0.33	0.35	0.37	0.40
0.30	0.35	0.35	0.40	0.44	0.49	0.51	0.54	0.56	0.58
0.28	0.30	0.33	0.35	0.40	0.44	0.47	0.49	0.51	0.54
0.26	0.28	0.30	0.33	0.35	0.40	0.44	0.47	0.49	0.51
0.19	0.21	0.21	0.23	0.26	0.28	0.30	0.33	0.35	0.37
0.16	0.19	0.19	0.21	0.23	0.26	0.28	0.30	0.33	0.35
0.19	0.21	0.21	0.23	0.26	0.26	0.28	0.28	0.30	0.33
0.16	0.19	0.19	0.21	0.23	0.23	0.26	0.26	0.28	0.30
0.19	0.21	0.21	0.23	0.26	0.26	0.28	0.28	0.30	0.33
0.16	0.19	0.19	0.21	0.23	0.23	0.26	0.26	0.28	0.28
0.14	0.14	0.16	0.16	0.19	0.19	0.21	0.23	0.26	0.28
0.12	0.14	0.14	0.14	0.16	0.19	0.19	0.21	0.23	0.26
0.20	0.23	0.25	0.28	0.30	0.33	0.36	0.38	0.41	0.43
0.18	0.20	0.23	0.25	0.28	0.30	0.33	0.36	0.38	0.41
0.15	0.18	0.18	0.20	0.20	0.23	0.23	0.25	0.25	0.28
0.13	0.15	0.15	0.18	0.18	0.20	0.20	0.23	0.23	0.25
0.10	0.13	0.13	0.15	0.15	0.18	0.20	0.20	0.20	0.25
0.10	0.10	0.13	0.13	0.15	0.15	0.18	0.18	0.20	0.20

**Coolant Recommendations**

Series	Stub, 3xD, 5xD		7xD		10xD	
	Pressure BAR	Flow Rate LPM	Pressure BAR	Flow Rate LPM	Pressure BAR	Flow Rate LPM
11	31	19	41	30	55	38
12	31	19	41	30	55	38
13	28	23	34	36	52	45
14	28	26	34	36	52	45
15	26	26	33	42	48	53
16	26	30	33	45	48	57
17	24	30	31	47	45	62
18	24	34	31	47	45	62
20	21	38	28	49	41	68
22	21	42	28	53	41	68
24	21	42	28	53	41	68
26	21	45	28	61	41	76
29	21	45	28	61	41	76
32	21	45	28	61	41	76

## Recommended Drilling Data | Metric (mm)

### GEN3SYS XT

ISO	Material	Hardness (BHN)	Speed (M/min)	Feed Rate (mm/rev) by Diameter			
				11 series 11.00 - 11.99	12 series 12.00 - 12.99	13 series 13.00 - 13.99	14 series 14.00 - 14.99
H	Wear Plate Hardox, AR400, T-1, etc.	400	45	0.12	0.12	0.14	0.14
		500	37	0.09	0.09	0.12	0.14
		600	25	0.09	0.09	0.09	0.12
	Hardened Steel	300 - 400	47	0.12	0.12	0.14	0.14
400 - 500		37	0.09	0.09	0.12	0.14	
K	SG / Nodular Cast Iron	120 - 150	146	0.23	0.28	0.30	0.33
		150 - 200	138	0.23	0.26	0.28	0.30
		200 - 220	123	0.19	0.23	0.26	0.28
		220 - 260	108	0.19	0.21	0.23	0.26
		260 - 320	97	0.19	0.19	0.21	0.23
	Grey / White Iron	120 - 150	152	0.28	0.30	0.33	0.35
		150 - 200	146	0.26	0.28	0.30	0.33
		200 - 220	131	0.23	0.26	0.28	0.30
220 - 260		113	0.21	0.23	0.26	0.28	
N	Cast Aluminum	30	300	0.28	0.30	0.33	0.35
		180	225	0.26	0.28	0.30	0.33
	Wrought Aluminum	30	425	0.30	0.35	0.37	0.40
		180	300	0.28	0.33	0.35	0.37
	Aluminum Bronze	100 - 200	110	0.23	0.26	0.28	0.28
		200 - 250	90	0.19	0.21	0.23	0.26
	Brass	100	200	0.23	0.28	0.30	0.33
Copper	60	130	0.07	0.07	0.07	0.09	

#### 7xD Adjustment Example (0.80 Adjustment)

Data • Adjustment Value	Speed/Feed (7xD)
61 M/min • 0.80	= 48.8 M/min
0.20 mm/rev • 0.80	= 0.16 mm/rev

#### 10xD Adjustment Example (0.70 Adjustment)

Speed • Adjustment Value	Speed/Feed (10xD)
61 M/min • 0.70	= 42.7 M/min
0.20 mm/rev • 0.70	= 0.14 mm/rev

#### **⚠ WARNING** Tool failure can cause serious injury. To prevent:

- When using holders without support bushing, use a short GEN3SYS holder to establish an initial hole that is a minimum of 2 diameters deep.
- Do not rotate tool holders more than 50 RPM unless it is engaged with the workpiece or fixture.

Visit [www.alliedmachine.com/DeepHoleGuidelines](http://www.alliedmachine.com/DeepHoleGuidelines) for the most up-to-date information and procedures. Factory technical assistance is available for your specific applications through our Application Engineering Team.

**IMPORTANT:** The speeds and feeds listed above are a general starting point for all applications. Refer to the coolant recommendation charts for coolant requirements to run at the recommended speeds and feeds. Factory technical assistance is available through our Application Engineering department. For 7xD and 10xD holder lengths, see adjustment example above.

A  
DRILLING  
B  
BORING  
C  
REAMING  
D  
BURNISHING  
E  
THREADING  
X  
SPECIALS

Feed Rate (mm/rev) by Diameter									
15 series 15.00 - 15.99	16 series 16.00 - 16.99	17 series 17.00 - 17.99	18 series 18.00 - 19.99	20 series 20.00 - 21.99	22 series 22.00 - 23.99	24 series 24.00 - 25.99	26 series 26.00 - 28.99	29 series 29.00 - 31.99	32 series 32.00 - 35.00
0.16	0.19	0.21	0.23	0.23	0.23	0.26	0.26	0.28	0.28
0.14	0.16	0.19	0.21	0.23	0.23	0.23	0.23	0.26	0.26
0.14	0.14	0.16	0.19	0.21	0.21	0.23	0.23	0.23	0.23
0.16	0.19	0.19	0.21	0.23	0.23	0.23	0.23	0.26	0.26
0.14	0.16	0.19	0.19	0.21	0.21	0.23	0.23	0.23	0.23
0.35	0.37	0.42	0.47	0.47	0.51	0.51	0.56	0.58	0.61
0.33	0.35	0.40	0.44	0.47	0.47	0.51	0.51	0.56	0.56
0.30	0.33	0.37	0.41	0.44	0.47	0.47	0.51	0.51	0.54
0.28	0.30	0.35	0.38	0.41	0.44	0.47	0.47	0.51	0.51
0.26	0.28	0.33	0.35	0.38	0.41	0.44	0.47	0.47	0.49
0.37	0.40	0.46	0.49	0.51	0.54	0.56	0.58	0.61	0.63
0.35	0.37	0.42	0.47	0.49	0.51	0.54	0.56	0.58	0.61
0.33	0.35	0.40	0.47	0.47	0.49	0.51	0.54	0.56	0.58
0.30	0.33	0.37	0.42	0.44	0.47	0.49	0.51	0.54	0.56
0.30	0.33	0.35	0.40	0.41	0.44	0.47	0.49	0.51	0.54
0.37	0.40	0.42	0.44	0.47	0.49	0.51	0.54	0.56	0.58
0.35	0.37	0.40	0.41	0.44	0.47	0.49	0.51	0.54	0.54
0.42	0.44	0.47	0.51	0.54	0.56	0.61	0.63	0.68	0.70
0.40	0.41	0.44	0.49	0.51	0.54	0.58	0.61	0.65	0.68
0.30	0.33	0.35	0.35	0.37	0.40	0.42	0.44	0.44	0.44
0.28	0.28	0.30	0.33	0.35	0.37	0.40	0.41	0.41	0.41
0.35	0.37	0.40	0.44	0.47	0.51	0.54	0.56	0.61	0.61
0.12	0.14	0.14	0.16	0.19	0.19	0.19	0.23	0.23	0.26

Coolant Recommendations

Series	Stub, 3xD, 5xD		7xD		10xD	
	Pressure BAR	Flow Rate LPM	Pressure BAR	Flow Rate LPM	Pressure BAR	Flow Rate LPM
11	31	19	41	30	55	38
12	31	19	41	30	55	38
13	28	23	34	36	52	45
14	28	26	34	36	52	45
15	26	26	33	42	48	53
16	26	30	33	45	48	57
17	24	30	31	47	45	62
18	24	34	31	47	45	62
20	21	38	28	49	41	68
22	21	42	28	53	41	68
24	21	42	28	53	41	68
26	21	45	28	61	41	76
29	21	45	28	61	41	76
32	21	45	28	61	41	76

## Tap Drill Information and Formulas | Imperial (inch)

### American - Unified Inch Screw Thread

Tap Size	Tap Drill Size	Decimal Equivalent	* Theo % Thread	Probable Mean Oversize	Probable Hole Size	** Probable % Thread
1/2 - 20	29/64	0.4531	72%	0.003	0.4561	68%
9/16 - 12	12.0 mm	0.4724	72%	0.003	0.4754	69%
	31/64	0.4844	83%	0.003	0.4874	80%
9/16 - 18	1/2	0.5000	87%	0.003	0.5030	82%
	13.0 mm	0.5118	70%	0.003	0.5148	66%
	31/64	0.5156	65%	0.003	0.5186	61%
5/8 - 11	17/32	0.5313	79%	0.003	0.5343	77%
5/8 - 12	35/64	0.5469	72%	0.003	0.5499	69%
5/8 - 18	9/16	0.5625	87%	0.003	0.5655	82%
	14.5 mm	0.5709	75%	0.003	0.5739	71%
	37/64	0.5781	65%	0.003	0.5811	61%
11/16 - 12	39/64	0.6094	72%	0.003	0.6124	69%
3/4 - 10	41/64	0.6406	84%	0.003	0.6436	82%
	16.5 mm	0.6496	77%	0.003	0.6526	75%
	21/32	0.6563	72%	0.003	0.6593	70%
3/4 - 12	43/64	0.6719	72%	0.003	0.6749	69%
3/4 - 16	11/16	0.6875	77%	0.003	0.6905	73%
	17.5 mm	0.6890	75%	0.003	0.6920	71%
7/8 - 9	49/64	0.7656	76%	0.003	0.7686	74%
	25/32	0.7813	65%	0.003	0.7843	63%
7/8 - 14	51/64	0.7969	84%	0.003	0.7999	81%
	13/16	0.8125	67%	0.003	0.8155	64%
15/16 - 12	55/64	0.8594	72%	0.003	0.8624	69%
15/16 - 20	57/64	0.8906	72%	0.003	0.8936	68%
1 - 8	22.0 mm	0.8661	82%	0.003	0.8691	81%
	7/8	0.8750	77%	0.003	0.8780	75%
	57/64	0.8906	67%	0.003	0.8936	65%
1 - 12	29/32	0.9063	87%	0.003	0.9093	84%
	59/64	0.9219	72%	0.003	0.9249	69%
1 - 14	15/16	0.9375	67%	0.003	0.9405	64%
1-1/8 - 12	1-1/32	1.0313	87%	0.003	1.0343	84%
	1-3/64	1.0469	72%	0.003	1.0499	69%
1-1/4 - 7	1-7/64	1.1094	76%	0.003	1.1124	74%

### Taper Pipe Thread (NPT)

Tap Size	Tap Drill Size	Decimal Equivalent	* Theo % Thread	Probable Mean Oversize	Probable Hole Size	** Probable % Thread
1/4 - 18	7/16	0.4375	-	0.003	0.4405	-
3/8 - 18	9/16	0.5625	-	0.003	0.5655	-
1/2 - 14	45/64	0.7031	-	0.003	0.7061	-
3/4 - 14	29/32	0.9063	-	0.003	0.9093	-

\* Based on nominal tap drill diameter  
 \*\* Based on .003" probable mean oversize

To calculate the percent of full thread for a given hole diameter:

$$\% \text{ Thread} = \# \text{ of threads per inch} \cdot \frac{(\text{Basic major diameter of thread} - \text{Drill hole size})}{.0130}$$

### Notes

- The above tap drill information represents probable thread percentages for the standard tap drills stocked at Allied Machine. Special insert diameters may be required in order to meet a user specific percentage of thread requirement.
- The .003 probable mean oversize hole condition is based on optimum cutting conditions. Probable percent of full thread may vary based on less ideal cutting conditions.
- The table and equations on this page are found in the *Machinery's Handbook*. Permission to simplify and print the equations is granted by the Editor of the *Machinery's Handbook*.

### Formulas

1.	<b>RPM</b>	<b>= (3.82 • SFM) / DIA</b>
	where:	
	RPM	= revolutions per minute (rev/min)
	SFM	= speed (ft/min)
	DIA	= diameter of drill (inch)
2.	<b>IPM</b>	<b>= RPM • IPR</b>
	where:	
	IPM	= inches per minute (in/min)
	RPM	= revolutions per minute (rev/min)
	IPR	= feed rate (in/rev)
3.	<b>SFM</b>	<b>= RPM • 0.262 • DIA</b>
	where:	
	SFM	= speed (ft/min)
	RPM	= revolutions per minute (rev/min)
	DIA	= diameter of drill (inch)
4.	<b>Thrust</b>	<b>= 153,700 • IPR • DIA • Km</b>
	where:	
	Thrust	= axial thrust (lbs)
	IPR	= feed rate (in/rev)
	DIA	= diameter of drill (inch)
	Km	= specific cutting energy (lbs/in <sup>2</sup> )
5.	<b>Tool Power</b>	<b>= .6991 • IPR • RPM • Km • DIA<sup>2</sup></b>
	where:	
	Tool Power	= tool power (HP)
	IPR	= feed rate (in/rev)
	RPM	= revolutions per minute (rev/min)
	Km	= specific cutting energy (lbs/in <sup>2</sup> )
	DIA	= diameter of drill (inch)

### Material Constants

Type of Material	Hardness	Km (lbs/in <sup>2</sup> )
Plain Carbon and Alloy Steel	85 - 200 BHN	0.79
	200 - 275 BHN	0.94
	275 - 375 BHN	1.00
High Temperature Alloys	-	1.44
Titanium Alloy	-	0.72
Stainless Steels	135 - 275 BHN	0.94
	30 - 45 RC	1.08
Cast Iron	100 - 200 BHN	0.50
	200 - 300 BHN	1.08
Copper Alloy	20 - 80 RB	0.43
	80 - 100 RB	0.72
Aluminum Alloy	-	0.22
Magnesium Alloy	-	0.16

## Tap Drill Information and Formulas | Metric (mm)

Tap Size	Tap Drill Size	Decimal Equivalent (inch)	* Theo % Thread	Probable Mean Oversize	Probable Hole Size	** Probable % Thread
12 X 1.25	27/64	0.4219	79%	0.075 mm	10.79 mm	74%
	10.8 mm	0.4252	74%	0.075 mm	10.88 mm	69%
14 X 2.0	15/32	0.4688	81%	0.075 mm	11.98 mm	78%
	12.0 mm	0.4724	77%	0.075 mm	12.08 mm	74%
14 X 1.5	12.5 mm	0.4921	77%	0.075 mm	12.58 mm	73%
16 X 2.0	14.0 mm	0.5512	77%	0.075 mm	14.08 mm	74%
16 X 1.5	14.5 mm	0.5709	77%	0.075 mm	14.58 mm	73%
	37/64	0.5781	68%	0.075 mm	14.76 mm	64%
18 X 2.5	15.5 mm	0.6102	77%	0.075 mm	15.58 mm	75%
18 X 1.5	16.5 mm	0.6496	77%	0.075 mm	16.58 mm	73%
	21/32	0.6563	68%	0.075 mm	16.75 mm	64%
20 X 2.5	11/16	0.6875	78%	0.075 mm	17.54 mm	76%
	17.5 mm	0.6890	77%	0.075 mm	17.58 mm	74%
20 X 1.5	18.5 mm	0.7283	77%	0.075 mm	18.58 mm	73%
	47/64	0.7344	69%	0.075 mm	18.66 mm	65%
22 X 2.5	49/64	0.7656	79%	0.075 mm	19.52 mm	76%
	19.5 mm	0.7677	77%	0.075 mm	19.58 mm	75%
22 X 1.5	20.5 mm	0.8071	77%	0.075 mm	20.58 mm	73%
	13/16	0.8125	70%	0.075 mm	20.71 mm	66%
24 X 3	13/16	0.8125	86%	0.075 mm	20.71 mm	84%
	21.0 mm	0.8268	76%	0.075 mm	21.08 mm	75%
24 X 2	22.0 mm	0.8661	77%	0.075 mm	22.08 mm	74%
	7/8	0.8750	68%	0.075 mm	22.30 mm	65%
27 X 3	24.0 mm	0.9449	77%	0.075 mm	24.08 mm	75%

### Formulas

1.	<b>RPM</b>	<b>= (318.47 • M/min) / DIA</b>
	where:	
	RPM	= revolutions per minute (rev/min)
	M/min	= speed (M/min)
	DIA	= diameter of drill (mm)
2.	<b>mm/min</b>	<b>= RPM • mm/rev</b>
	where:	
	mm/min	= mm per minute (mm/min)
	RPM	= revolutions per minute (rev/min)
	mm/rev	= feed rate (mm/rev)
3.	<b>M/min</b>	<b>= RPM • 0.003 • DIA</b>
	where:	
	M/min	= speed (M/min)
	RPM	= revolutions per minute (rev/min)
	DIA	= diameter of drill (mm)
4.	<b>Thrust</b>	<b>= 154 • (mm/rev) • DIA • K<sub>m</sub></b>
	where:	
	Thrust	= axial thrust (N)
	mm/rev	= feed rate (mm/rev)
	DIA	= diameter of drill (mm)
	K <sub>m</sub>	= specific cutting energy (kPa)
5.	<b>Tool Power</b>	<b>= ((mm/rev) • RPM • K<sub>m</sub> • DIA<sup>2</sup>) / 218604.8</b>
	where:	
	Tool Power	= tool power (HP)
	mm/rev	= feed rate (mm/rev)
	RPM	= revolutions per minute (rev/min)
	K <sub>m</sub>	= specific cutting energy (kPa)
	DIA	= diameter of drill (mm)

### BSP and ISO 7-1

Tap Size	Tap Drill Size	Decimal Equivalent	* Theo % Thread	Probable Mean Oversize	Probable Hole Size	** Probable % Thread
1/4-19	7/16"	0.4375"	-	0.075 mm	11.19 mm	-
3/8-19	37/64"	0.5781"	-	0.075 mm	14.76 mm	-
1/2-14	23/32"	0.7188"	-	0.075 mm	18.33 mm	-
3/4-14	15/16"	0.9375"	-	0.075 mm	23.89 mm	-

\* Based on nominal tap drill diameter

\*\* Based on 0.075mm probable mean oversize

To calculate the percent of full thread for a given hole diameter:

$$\% \text{ Thread} = \frac{76.93}{\text{Pitch (mm)}} \cdot (\text{Basic major diameter} - \text{Drill hole size})$$

### Notes

- The above tap drill information represents probable thread percentages for the standard tap drills stocked at Allied Machine. Special insert diameters may be required in order to meet a user specific percentage of thread requirement.
- The .075mm probable mean oversize hole condition is based on optimum cutting conditions. Probable percent of full thread may vary based on less ideal cutting conditions.
- The table and equations on this page are found in the *Machinery's Handbook*. Permission to simplify and print the equations is granted by the Editor of the *Machinery's Handbook*.

### Material Constants

Type of Material	Hardness	Km (kPa)
Plain Carbon and Alloy Steel	85 - 200 BHN	5.45
	200 - 275 BHN	6.48
	275 - 375 BHN	6.89
	375 - 425 BHN	7.93
High Temperature Alloys	-	9.93
Titanium Alloy	-	4.96
Stainless Steels	135 - 275 BHN	6.48
	30 - 45 RC	7.45
Cast Iron	100 - 200 BHN	3.45
	200 - 300 BHN	7.45
Copper Alloy	20 - 80 RB	2.96
	80 - 100 RB	4.96
Aluminum Alloy	-	1.52
Magnesium Alloy	-	1.10

## Deep Hole Drilling Guidelines

GEN3SYS XT Pro | 10xD Holders

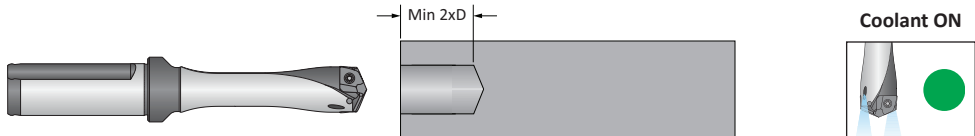
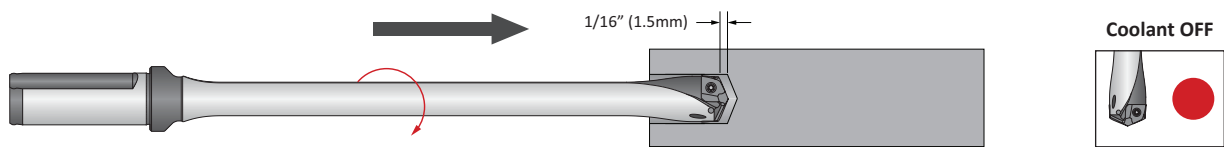
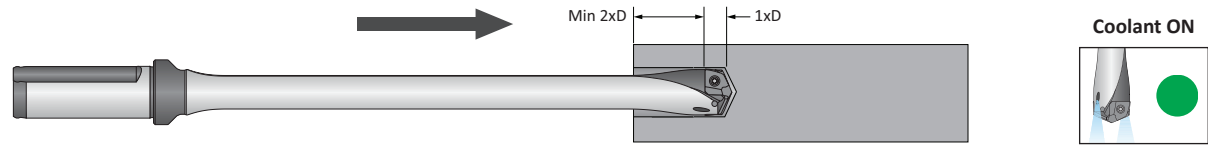
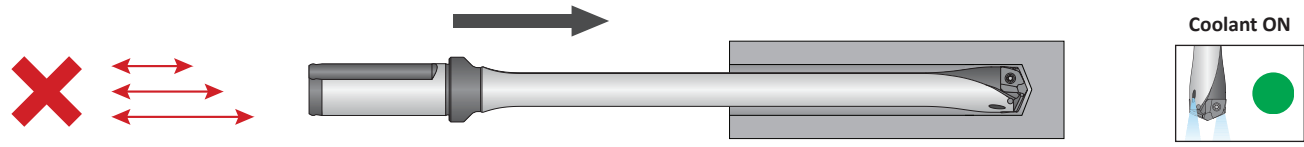
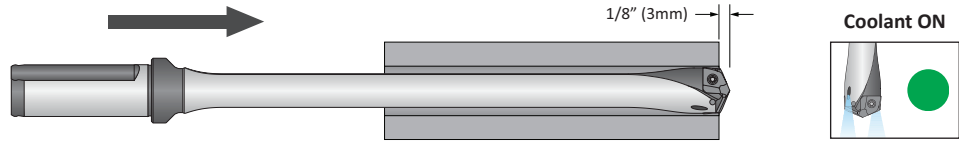
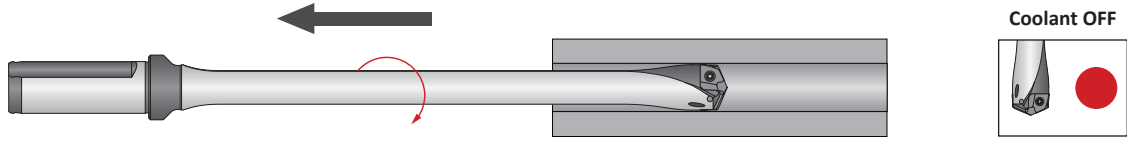
A DRILLING	<p><b>1. Pilot Hole</b> 100 % RPM 100% IPR (mm/rev)</p>	<p>Establish the pilot hole using the same diameter short drill to a depth of 2xD minimum. Utilize a pilot drill with the same or larger included point angle.</p>	
B BORING	<p><b>2. Feed-in</b> 50 RPM max 12 IPM (300 mm/min)</p>	<p>Feed the longer drill within 1/16" (1.5mm) short of the established pilot hole bottom at a <b>maximum of 50 RPM</b> and 12 IPM (300 mm/min) feed rate.</p>	
C REAMING	<p><b>3. Deep Hole Transition Drilling</b> 50 % RPM 75% IPR (mm/rev)</p>	<p>Drill additional 1xD past the bottom of the pilot hole at 50% reduction of recommended speed and 25% reduction of recommended feed. Minimum of 1 second dwell is required to meet full speed before feeding.</p>	
D BURNISHING	<p><b>4. Deep Hole Drilling - Blind</b> 100% RPM 100% IPR (mm/rev)</p>	<p>Drill to full depth at recommended speed and feed for longer drill according to Allied speed and feed charts. <b>No peck cycle recommended.</b></p>	
E THREADING	<p><b>5. Deep Hole Drilling - at Breakout</b> 50% RPM 75% IPR (mm/rev)</p>	<p><b>For through holes only:</b> Reduce speed by 50% and feed by 25% prior to breakout. Do not breakout more than 1/8" (3mm) past the full diameter of the drill.</p>	
X SPECIALS	<p><b>6. Drill Retract</b> 50 RPM max</p>	<p>Reduce speed to a <b>maximum of 50 RPM</b> before retracting from the hole.</p>	

**1. WARNING** Tool failure can cause serious injury. To prevent:

- When using holders without support bushing, use a short GEN3SYS holder to establish an initial hole that is a minimum of 2 diameters deep.
- Do not rotate tool holders more than 50 RPM unless it is engaged with the workpiece or fixture.

Visit [www.alliedmachine.com/DeepHoleGuidelines](http://www.alliedmachine.com/DeepHoleGuidelines) for the most up-to-date information and procedures. Factory technical assistance is available for your specific applications through our Application Engineering Team.



## Troubleshooting Guide

	Potential Problem																				Possible Solutions
	Accelerated corner wear	Barber pole	Bell mouth hole	Insert chipping	Blue chips	Build Up Edge (BUE)	Chatter	Chip packing	Chipping of point	Damaged or broken tools	Excessive margin wear	High flank wear	Hole lead off	Hole out of position	Hole out of round	Over-size hole	Poor hole finish	Poor tool life	Power spikes - Load meter	Retract spiral	
Setup Condition	1	2	3	4	5	6	7	8	9	10	11	12	13	14	15	16	17	18	19	20	Possible Solutions
Worn or misaligned spindle (lathe, screw machine, chucker)	1		3				7		9	10	11		13			16	17			20	<ul style="list-style-type: none"> <li>Align spindle and turret or tailstock.</li> <li>Repair spindle.</li> </ul>
Use of low rigidity machine tools		2	3	4			7		9	10			13	14						20	<ul style="list-style-type: none"> <li>Reduce penetration rate to fall within the physical limits of the machine or setup (<b>NOTICE:</b> Do not reduce feed below threshold of good chip formation).</li> </ul>
Poor work piece support		2		4			7			10	11				15		17			20	<ul style="list-style-type: none"> <li>Provide additional support for the work piece.</li> <li>Reduce penetration rate to fall within the physical limits of the machine or setup (<b>NOTICE:</b> Do not reduce feed below threshold of good chip formation).</li> </ul>
Flood coolant, low coolant pressure, or low coolant volume	1				5	6		8		10		12				16	17	18	19		<ul style="list-style-type: none"> <li>Run coolant through tool holder when drilling greater than 1xD.</li> <li>Increase coolant pressure and volume through the tool holder.</li> <li>Reduce penetration rate to fall within the coolant limitations (<b>NOTICE:</b> Do not reduce feed below threshold of good chip formation).</li> <li>Add a peck cycle to help clear chips.</li> </ul>
Interrupted cuts. Entry or exit surfaces that are not perpendicular to the spindle (draft angles, parting lines, curved or stepped surfaces, cross holes, and cast or forged surfaces)				4			7		9	10	11		13	14	15	16	17	18			<ul style="list-style-type: none"> <li>Pre-mill (spot face) entry or exit surface to remove interruption.</li> <li>Decrease feed as much as 50% through entry or exit interruption.</li> <li>Use short holders in low impact entry cuts.</li> </ul>
Material harder than expected or running tools beyond recommended speed	1				5	6				10		12							18		<ul style="list-style-type: none"> <li>Reduce speed.</li> <li>Increase coolant pressure and volume.</li> <li>Improve coolant condition by use of quality products and regular maintenance.</li> </ul>
Poor material micro-structure or foreign particles (forgings and castings that have not been normalized or annealed, poorly prepared steel, flame cut parts, and sand casting)				4		6				10		12	13						18		<ul style="list-style-type: none"> <li>Compare performance of other tools for similar wear problems, which may indicate poor micro-structure. Anneal or normalize parts to improve micro-structure for machining.</li> <li>Reduce feeds (<b>NOTICE:</b> Do not reduce feed below threshold of good chip formation).</li> </ul>
Poor chip control								8		10	11		13			16	17	18	19		<ul style="list-style-type: none"> <li>Increase feed to recommended levels. Contact Allied Application Engineering group for technical recommendations.</li> <li>Increase coolant pressure and volume.</li> <li>Improve coolant condition by use of quality products and regular maintenance.</li> </ul>
Spot drilled holes with included angle less than that matching GEN3SYS XT or cored holes	1			4			7							13					18		<ul style="list-style-type: none"> <li>Spot hole with short tool of same or greater included angle as GEN3SYS XT drill insert.</li> <li>Reduce feed (<b>NOTICE:</b> Do not reduce feed below threshold of good chip formation). If possible, drill from solid.</li> </ul>

A  
DRILLING  
B  
BORING  
C  
REAMING  
D  
BURNISHING  
E  
THREADING  
X  
SPECIALS



SECTION

---

# A30

---

T-A® Drilling System

# T-A® Drilling System

Replaceable Insert Drilling System | GEN2 T-A® | Original T-A®

► Diameter Range: 0.374" - 4.507" (9.50mm - 114.48mm)



## This is Not Yesterday's Spade Drill

The T-A drilling system is an innovation inspired by the Universal replaceable spade insert drilling system. However, with the development of the GEN2 T-A insert, along with the countless geometry options for the Original T-A, this drilling system provides benefits and performance that spade blade inserts of the past never could.

With constant innovations in holder designs, insert geometries and coatings, and coolant dispersion, the T-A drilling system continues to evolve and become much more productive and powerful than ever before.

Excellent hole size and finish	Optimizes chip evacuation	Wide range of geometry options available
--------------------------------	---------------------------	--

## Applicable Industries

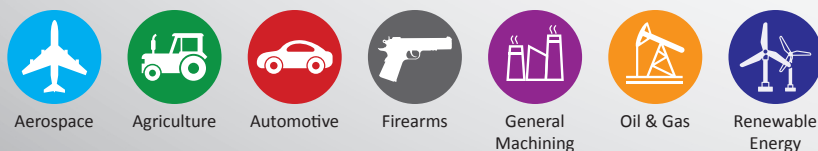

Your safety and the safety of others is very important. This catalog contains important safety messages. Always read and follow all safety precautions.



This triangle is a safety hazard symbol. It alerts you to potential safety hazards that can cause tool failure and serious injury.

When you see this symbol in the catalog, look for a related safety message that may be near this triangle or referred to in the nearby text.

There are safety signal words also used in the catalog. Safety messages follow these words.

### **WARNING**

**WARNING** (shown above) means that failure to follow the precautions in this message could result in tool failure and serious injury.

**NOTICE** means that failure to follow the precautions in this message could result in damage to the tool or machine but not result in personal injury.

**NOTE** and **IMPORTANT** are also used. These are important that you read and follow but are not safety-related.

Visit [www.alliedmachine.com](http://www.alliedmachine.com) for the most up-to-date information and procedures.

**Reference Icons**

The following icons will appear throughout the catalog to help you navigate between products.

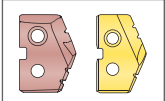

**T-A Inserts**

Refers to the range of inserts that connect with the corresponding holders

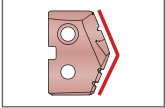

**Available Insert Geometries**

Details for the different geometry options available for each T-A insert style

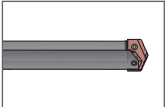

**T-A Holders**

Refers to the range of holders that connect with the corresponding inserts

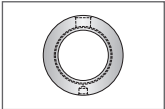

**Rotary Coolant Adapter (RCA) Information**

Detailed instructions and information regarding the corresponding part(s)



**T-ACR Chamfer Rings**

Refers to the range of T-ACR chamfer rings available for the corresponding holders



**Technical Information**

Detailed instructions and information regarding the corresponding part(s)

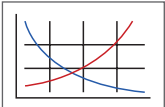

**Recommended Cutting Data**

Speed and feed recommendations for optimum and safe drilling

Series	Diameter Range	
	Imperial (inch)	Metric (mm)
<b>Y</b>	0.374 - 0.436	9.50 - 11.07
<b>Z</b>	0.437 - 0.510	11.10 - 12.95
<b>0</b>	0.511 - 0.695	12.98 - 17.65
<b>1</b>	0.690 - 0.960	17.53 - 24.38
<b>2</b>	0.961 - 1.380	24.41 - 35.05
<b>3</b>	1.353 - 1.882	34.36 - 47.80
<b>4</b>	1.850 - 2.570	46.99 - 65.28
<b>5</b>	2.456 - 3.000	62.38 - 76.20
<b>6</b>	3.001 - 3.507	76.22 - 89.08
<b>7</b>	3.508 - 4.000	89.10 - 101.60
<b>8</b>	4.001 - 4.507	101.63 - 114.48

**Introduction Information**

T-A Inserts Overview . . . . . 2 - 3  
 T-A Insert Geometries . . . . . 4 - 6  
 T-A Holders Overview . . . . . 7  
 Technical Information . . . . . 8 - 9  
 Product Nomenclature . . . . . 10 - 11

**T-A Drill Series**

Y Series . . . . . 12 - 21  
 Z Series . . . . . 22 - 31  
 0 Series . . . . . 32 - 43  
 1 Series . . . . . 44 - 57  
 2 Series . . . . . 58 - 73  
 3 Series . . . . . 74 - 85  
 4 Series . . . . . 86 - 93  
 5 and 6 Series . . . . . 94 - 101  
 7 and 8 Series . . . . . 102 - 109

**T-A Drill Adapters**

Rotary Coolant Adapters (RCA) . . . . . 110  
 T-ACR Chamfer Rings . . . . . 111















**Recommended Cutting Data**

Imperial (inch)	GEN2 T-A . . . . . 112 - 115
	Original T-A . . . . . 116 - 119
	Flat Bottom Geometry . . . . . 120 - 123
	Diamond Coating . . . . . 124
	Tap Drill Information . . . . . 125
	Coolant Recommendations . . . . . 126 - 127
Metric (mm)	GEN2 T-A . . . . . 128 - 131
	Original T-A . . . . . 132 - 135
	Flat Bottom Geometry . . . . . 136 - 139
	Diamond Coating . . . . . 140
	Tap Drill Information . . . . . 141
	Coolant Recommendations . . . . . 142 - 143















**Troubleshooting Guide . . . . . 144 - 145**

**Deep Hole Drilling Guidelines . . . . . 146**





T-A Drilling System Overview | Drill Inserts









Series	Y Series	Z Series	0 Series	1 Series	2 Series	3 Series	4 Series
GEN2 T-A							
D <sub>1</sub> inch	0.374 - 0.436	0.437 - 0.510	0.511 - 0.695	0.690 - 0.960	0.961 - 1.380	1.353 - 1.882	1.850 - 2.570
D <sub>1</sub> mm	9.5 - 11.07	11.10 - 12.95	12.98 - 17.65	17.53 - 24.38	24.41 - 35.05	34.36 - 47.80	46.99 - 65.28
Half Series Option*							
HSS Substrates	Super Cobalt	Super Cobalt	Super Cobalt	Super Cobalt	Super Cobalt	HSS Super Cobalt Premium Cobalt	HSS Super Cobalt
Carbide Substrates	C1 (K35) C2 (K20)	C1 (K35) C2 (K20)	C1 (K35) C2 (K20)	C1 (K35) C2 (K20)	C1 (K35) C2 (K20)	-	-
Coatings	AM200® AM300®	AM200® AM300®	AM200® AM300®	AM200® AM300®	AM200® AM300®	AM200® TiN	AM200® TiN









\*See page A30: 7 for more information regarding half series options

Series	Y Series	Z Series	0 Series	1 Series	2 Series	3 Series	4 Series
Original T-A							
D <sub>1</sub> inch	0.374 - 0.436	0.437 - 0.510	0.511 - 0.695	0.690 - 0.960	0.961 - 1.380	1.353 - 1.882	1.850 - 2.570
D <sub>1</sub> mm	9.5 - 11.07	11.10 - 12.95	12.98 - 17.65	17.53 - 24.38	24.41 - 35.05	34.36 - 47.80	46.99 - 65.28
Half Series Option*							
HSS Substrates	Super Cobalt Premium Cobalt	Super Cobalt Premium Cobalt	Super Cobalt Premium Cobalt	HSS Super Cobalt Premium Cobalt	HSS Super Cobalt Premium Cobalt	Super Cobalt	Super Cobalt
Carbide Substrates	C2 (K20) C3 (K10) C5 (P40) N2	C2 (K20) C3 (K10) C5 (P40) N2	C2 (K20) C3 (K10) C5 (P40) N2	C2 (K20) C3 (K10) C5 (P40) N2	C2 (K20) C3 (K10) C5 (P40) N2	C2 (K20) C5 (P40)	-
Coatings	TiN TiAlN TiCN	TiN TiAlN TiCN	TiN TiAlN TiCN	TiN TiAlN TiCN	TiN TiAlN TiCN	TiN	TiN

\*See page A30: 7 for more information regarding half series options

Drill Insert Coatings				
				
<p><b>AM300®</b></p> <ul style="list-style-type: none"> <li>Increased heat resistance over AM200® coating</li> <li>Up to 20% increased tool life over AM200 coating</li> <li>Provides superior tool life at high penetration rates</li> <li>Color: copper/orange</li> </ul>	<p><b>AM200®</b></p> <ul style="list-style-type: none"> <li>First choice for increased heat resistance over TiN, TiCN, and TiAlN with improved wear capabilities</li> <li>Allows for improved tool life and higher penetration rates</li> <li>Over 20% increase in tool life compared to TiAlN coating</li> <li>Color: copper/bronze</li> </ul>	<p><b>TiN</b></p> <ul style="list-style-type: none"> <li>General purpose coating</li> <li>Improved tool life over non-coated inserts</li> <li>Excellent choice for aluminum</li> <li>Color: gold/yellow</li> </ul>	<p><b>TiAlN</b></p> <ul style="list-style-type: none"> <li>Excellent choice for wear resistance over high surface speeds</li> <li>Excellent oxidation resistance</li> <li>Maximum working temperature 800°C</li> <li>Color: violet/gray</li> </ul>	<p><b>TiCN</b></p> <ul style="list-style-type: none"> <li>Excellent choice for wear resistance over low surface speeds</li> <li>High hardness/wear resistance</li> <li>Maximum working temperature 400°C</li> <li>Color: blue/gray</li> </ul>

5 Series	6 Series	7 Series	8 Series
			
2.456 - 3.000	3.001 - 3.507	3.508 - 4.000	4.001 - 4.507
62.38 - 76.20	76.22 - 89.08	89.10 - 101.60	101.63 - 114.48
			
HSS Super Cobalt	HSS Super Cobalt	HSS Super Cobalt	HSS Super Cobalt
-	-	-	-
AM200® TiN	AM200® TiN	AM200® TiN	AM200® TiN

5 Series	6 Series	7 Series	8 Series
			
2.456 - 3.000	3.001 - 3.507	3.508 - 4.000	4.001 - 4.507
62.38 - 76.20	76.22 - 89.08	89.10 - 101.60	101.63 - 114.48
			
HSS Super Cobalt	HSS Super Cobalt	HSS Super Cobalt	HSS Super Cobalt
-	-	-	-
TiN	TiN	TiN	TiN

Drill Insert Grades			
<p><b>HSS (Original / GEN2)</b></p> <p>First choice for general purpose use. Suited for difficult machining applications with low rigidity, as well as deep hole drilling. Recommended for drilling most steels, cast irons, and aluminum alloys up to 275 BHN 96.</p>	<p><b>HSS Super Cobalt (Original / GEN2)</b></p> <p>Suited for good-to-rigid machining applications, used for drilling exotic and high alloy materials, or general use when surface speed needs to be increased. For use in material hardness up to 350 BHN 121.</p>	<p><b>HSS Premium Cobalt (Original / GEN2)</b></p> <p>Suited for rigid machining applications, used for drilling exotic and high alloy materials, or general use when surface speed needs to be increased. For material hardness up to 400 BHN 139.</p>	<p><b>Carbide C5 (P40) (Original only)</b></p> <p>Excellent for drilling free machining steel, low/medium carbon steels, alloy steels, high strength steels, tool steels, and hardened steels.</p>
<p><b>Carbide C3 (K10) (Original only)</b></p> <p>Designed for drilling grey/white cast irons. The special geometry offers substantial increase in penetration rates and provides exceptional edge strength and tool life.</p>	<p><b>Carbide C2 (K20) (Original / GEN2)</b></p> <p>Excellent for drilling high temperature alloys, titanium alloys, cast aluminum, SG/Nodular cast iron, grey/white iron, aluminum bronze, brass, copper, and certain stainless steels.</p>	<p><b>Carbide C1 (K35) (Original / GEN2)</b></p> <p>Excellent for drilling free machining steel, low/medium carbon steels, alloy steels, high strength steels, tool steels, and hardened steels.</p>	<p><b>Carbide N2 (Original only)</b></p> <p>Allied's N2 carbide is used with CVD diamond coating. This improves the insert's hardness, durability, and performance, which extends tool life between 30 - 50x over uncoated carbide.</p>

## Insert Geometries

### There's a Geometry for That

Allied Machine knows there isn't a one-size-fits-all solution when it comes to holemaking. To better accommodate the countless holes our customers drill, we have developed multiple geometry options, with new geometries in development at all times.

If you're unsure which geometry would be best for your application, give our Application Engineers a call. They're standing by, ready to point you in the right direction.

☎ 1.330.343.4283

☎ 1.800.321.5537 (toll free United States and Canada)

✉ [appeng@alliedmachine.com](mailto:appeng@alliedmachine.com)

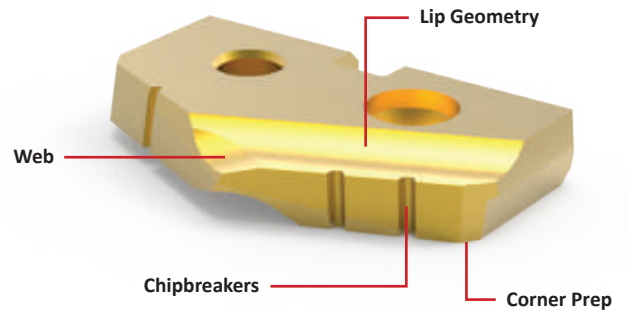

**GEN2 T-A Drill Inserts**

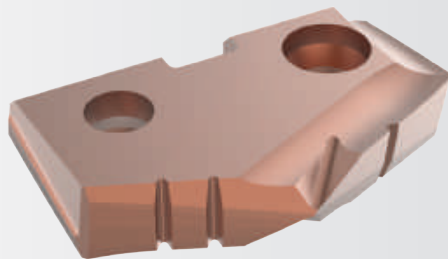

**Original T-A Drill Inserts**

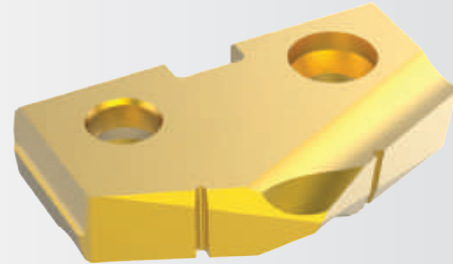

#### Standard

- Offers substantial increases in penetration rates and tool life
- Improves centering, drill stability, chip formation, and lowers drill forces
- Provides smoother break-out on through hole applications



#### Standard

- Offers excellent penetration rates and tool life
- Smooth break-out on through holes
- Increases drill stability and chip formation
- Ideally suited for low-to-high rigidity machining applications

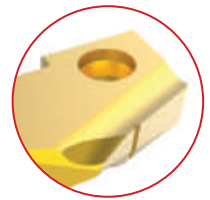

#### High Efficiency (-HE)

- Excellent chip formation in materials with very high elasticity/ductility and poor chip forming conditions
- Effective in lower powered machines
- Material example: low carbon steel (not suitable for stainless steel)

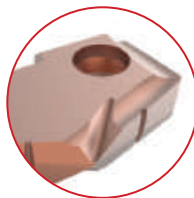

#### Tiny Chip (-TC)

- Unique lip and point design for excellent chip control
- Improves drilling capabilities in long-chipping materials
- Enhanced performance in lower-powered machines

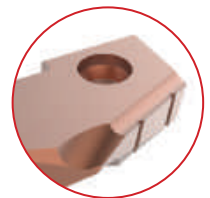

#### Corner Radius (-CR)

- Improves exit burrs
- Excellent surface finish in most applications
- Improves heat dispersion and tool life
- Can be used in addition to other geometries (as a special)

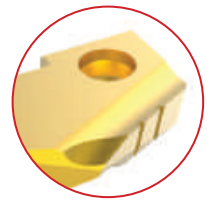

#### Special Corner Preparation (-SK)

- Ideal for machining cast iron materials
- Larger than a standard corner clip
- Improves heat resistance
- Standard feature on CI, HI, and HR geometries

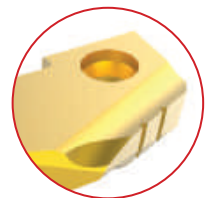

continued on next page



**Cam Point (-CP)**

- Helical cam ground point
- Improves drill stability and centering characteristics
- Reduces bell mouching when using longer holders
- Target materials: steels, cast/forged steels, cast iron

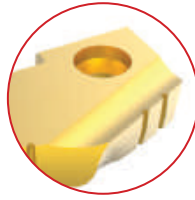

**Notch Point® (-NP)**

- Reduces bell mouth and lead-off
- Increases stability in deep hole applications
- Reduces thrust
- Can be used in addition to other geometries like Cast Iron, High Rake, and High Impact



**High Impact (-HI)**

- Designed for materials with hardness > 200 BHN (700 N/mm²)
- Enhances chip formation in materials with high elasticity/ductility and poor chip forming characteristics
- SK corner clip improves tool life
- Target materials: structural/cast and forged steels (not suitable for stainless steel)

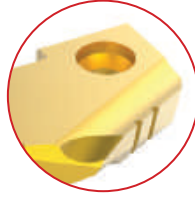

**High Impact Notch Point® (-IN)**

- Combination of High Impact and Notch Point geometries
- Increases stability in deep hole applications
- Enhances chip formation in materials with high elasticity/ductility and poor chip forming characteristics

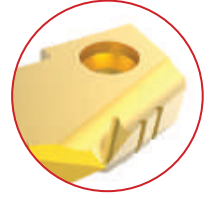

**High Rake (-HR)**

- Designed for materials with hardness < 200 BHN (700 N/mm²)
- Improves chip formation in materials with very high elasticity/ductility, extremely poor chip forming characteristics, and low material hardness
- SK corner clip improves tool life
- Target materials: soft steels, steel castings and forgings (not suitable for stainless steel)

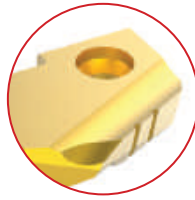

**High Rake Notch Point® (-RN)**

- Combination of High Rake and Notch Point geometries
- Reduces bell mouth and lead-off
- Improves chip formation in materials with very high elasticity/ductility, extremely poor chip forming characteristics, and low material hardness

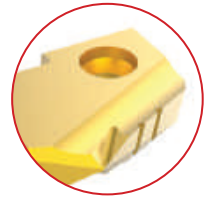

**Cast Iron (-CI)**

- Specifically designed for use in grey and white cast irons
- Exceptional edge strength
- SK2 corner preparation for improved tool life
- Standard geometry on C3 (K10) carbide inserts



**Cast Iron Notch Point® (-CN)**

- Combination of Cast Iron and Notch Point geometries
- Increases stability in deep hole applications
- Specifically designed for use in grey and white cast irons



**Aluminum (-AN)**

- First choice for machining aluminum
- Enhanced geometry improves chip formation and hole quality
- TiN coating improves heat resistance and extends tool life

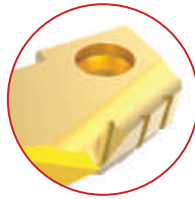

**Brass (-BR)**

- Improves tool life due to the specialized geometry and edge preparation
- Reduces self-feed tendency

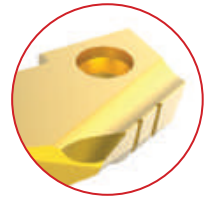

**90° Spot and Chamfer (-SP)**

- Center cutting web design improves stability and strength
- Eliminates the need for a secondary chamfering operation
- Available with chipbreakers (see -SW below)

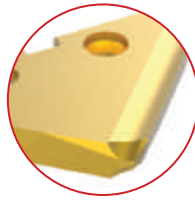

**Flat Bottom (-FB)**

- Ideal for flattening or squaring the bottom of pre-existing holes with high rigidity
- Includes small 10° point on the nose of the insert
- Available without chipbreakers (see -FN below)

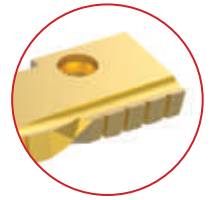

**90° Spot and Chamfer (-SW)**

- Center cutting web design improves stability and strength
- Eliminates the need for a secondary chamfering operation
- With added chipbreakers

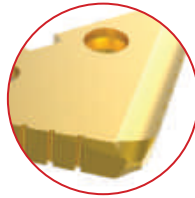

**Flat Bottom (-FN)**

- Ideal for flattening or squaring the bottom of pre-existing holes with high rigidity
- Includes small 10° point on the nose of the insert
- Available with chipbreakers (see -FB above)

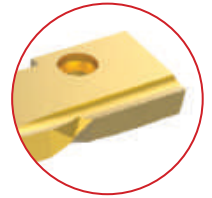

## Available Standard Insert Geometries

The following table shows which geometries are available as a standard item (based on insert type and series). If you need a geometry on your insert, but it is not listed as available, please call the Application Engineering department to discuss quoting your insert as a special to include the desired geometry.

Additional lead time and process fees may apply.

Available Additional Geometries		GEN2 T-A			Original T-A							
		Y - 2 Series	3 - 4 Series	5 - 8 Series	HSS Inserts				Carbide Inserts			
					Y - 2 Series	3 Series	4 Series	5 - 8 Series	Y - Z Series	0 - 2 Series	3 Series	
-AN	Aluminum				●					●	●	
-BT	BT-A Specific										●	●
-BR	Brass		●	●	●	●	●	●		●	●	●
-CI	Cast Iron		●		●	●	●			●	●	●
-CN	Notch Point® Cast Iron				●					●	●	●
-CP	Cam Point				●					●	●	
-CR	Corner Radius		●	●	●	●	●	●		●	●	●
-FB	Flat Bottom				●	●	●					
-HE	High Efficiency	●	●									
-HI	High Impact		●	●	●	●	●	●		●	●	●
-HR	High Rake		●	●	●	●	●	●		●	●	●
-IN	Notch Point® High Impact				●					●	●	●
-NC	No Chipbreaker		●	●	●	●	●	●		●	●	●
-NP	Notch Point®				●					●	●	●
-RN	Notch Point® High Rake				●					●	●	●
-SK	Special Corner Preparation		●	●	●	●	●	●		●	●	●
-SP	90° Spot and Chamfer				●	●						
-SS	150° Structural Steel				●	●						
-TC	Tiny Chip				●					●	●	
-TW	Thin Wall				●	●						
-WC	No Corner Clips		●	●	●	●	●	●		●	●	●

## Drill Holders

**Holder Length Options** (for use with both GEN2 and Original T-A inserts)



**Stub Length** | Series: Y - 3 (straight flute flanged shank only)



**Short Length** | Series: ALL



**Intermediate Length** | Series: ALL



**Standard Length** | Series: ALL



**Standard Plus Length** | Series: Y - 2 (helical flute flanged shank only)



**Extended Length** | Series: 0 - 3



**Long Length** | Series: 0 - 2



**Long Plus Length** | Series: 0



**XL Length** | Series: ALL



**3XL Length** | Series: ALL

**Holder Shank Options**



**ER Collet Shank**  
Series: Y, Z, 0



**Straight Shank**  
Series: ALL



**Morse Taper Shank**  
Series: ALL



**Flanged Shank**  
Series: ALL

### Half Series Holders (0.5, 1.5, 2.5)

Half series holders are recommended when running carbide inserts toward the upper end of the series drill range, as well as in tougher applications requiring more insert support and holder strength. **NOTE:** Only specified half series inserts should be used with half series holders.



Standard Series Insert +  
Standard Series Holder



Half Series Insert +  
Standard Series Holder



Half Series Insert +  
Half Series Holder



Standard Series Insert +  
Half Series Holder

**⚠ WARNING** Refer to Speed and Feed charts for recommended adjustments to speeds and feeds. Refer to page A30: 146 for deep hole drilling guidelines in this section of the catalog. Visit [www.alliedmachine.com/DeepHoleGuidelines](http://www.alliedmachine.com/DeepHoleGuidelines) for the most up-to-date information and procedures. Factory technical assistance is available for your specific applications through our Application Engineering Team.

## Technical Information

### Next Level Solutions: GEN2 T-A

What takes a solution to the next level? When you make innovative designs and enhancements to a product that already achieves high performance results, you push the boundaries of what is known. And when you push the known boundaries, the unknown becomes the next level.

After all, everything begins as unknown.

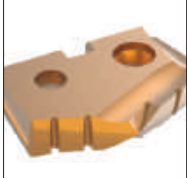
	<p style="text-align: center;"><b>AM300® Coating</b></p> <ul style="list-style-type: none"> <li>• Provides superior tool life at high penetration rates</li> <li>• Improves heat resistance over AM200® coating</li> <li>• Increases tool life up to 20% over AM200 coating</li> </ul>
---	--

	<p style="text-align: center;"><b>AM200® Coating</b></p> <ul style="list-style-type: none"> <li>• Improves heat resistance over TiN, TiCN, and TiAlN with improved wear capabilities</li> <li>• Increases penetration rates</li> <li>• Increases tool life more than 20% over TiAlN coating</li> </ul>
---	--

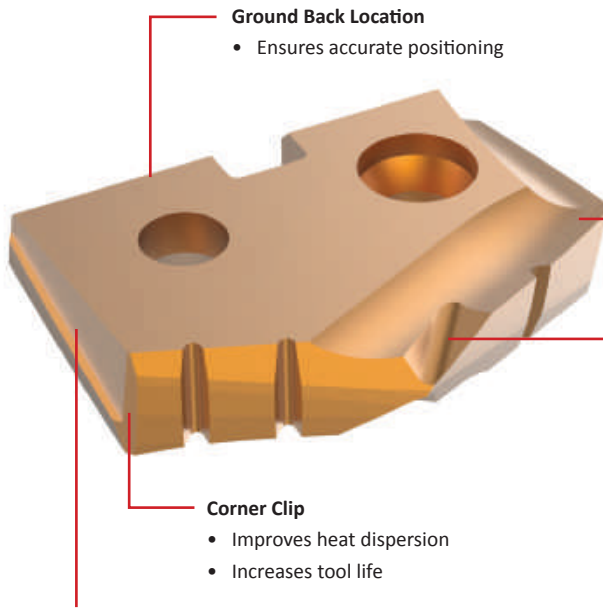

**Ground Back Location**

- Ensures accurate positioning

**Curved Cutting Edge** (not all series)

- Enhances chip formation

**Notch Point® Geometry**

- Improves stability and hole straightness
- Reduces thrust

**Corner Clip**

- Improves heat dispersion
- Increases tool life

**Helical Margin** (not all series)

- Increases drill stability

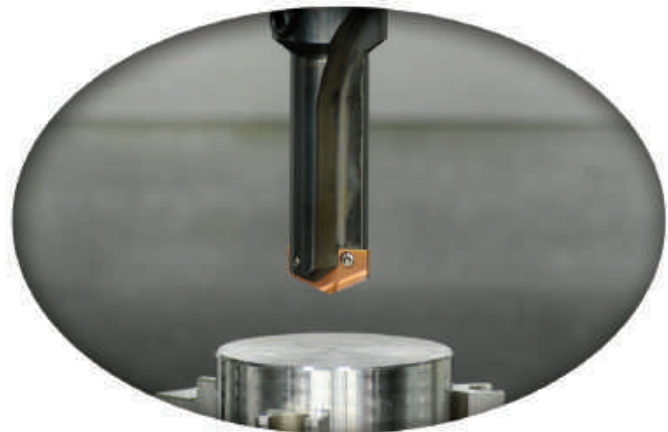

### Improving Chip Formation

Achieving optimal chip formation is crucial. The quality of the chips being produced directly affects everything in the entire process: the cycle time, the tool life, the scrap rate, and the quality and condition of the final machined hole.

We know how important chip formation is. That's why we constantly improve and develop new geometries to create a better, more productive T-A product.

### Setting Up New Applications

- Check coolant flows adequately through the tool before beginning
- Drill a short hole 1xD deep initially
- The chips produced should be short in length and material colored, not straw or blue
- Measure the hole produced to check that it is within the desired tolerance
- If all is correct, continue to machine the remainder of the hole
- Ensure the drilling process is quiet and smooth with no chip packing

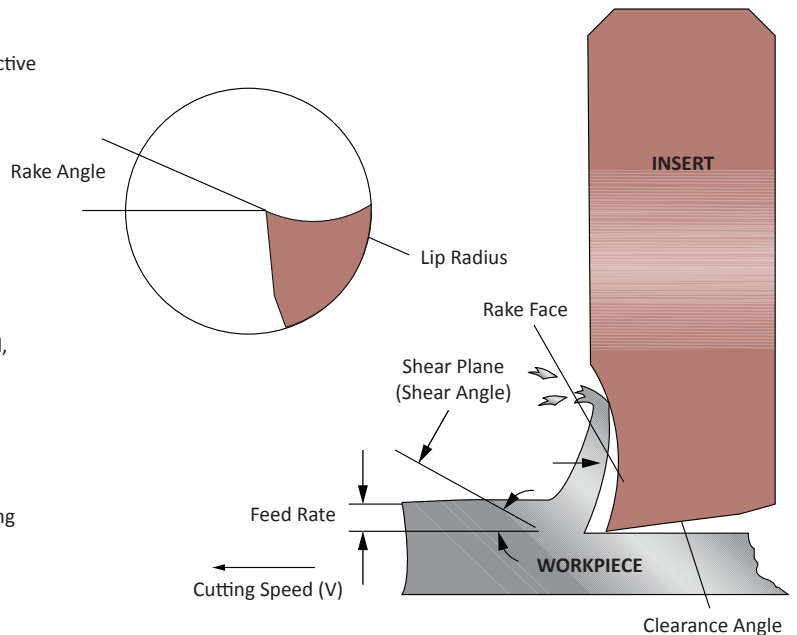

**Wear vs Toughness**

When selecting a grade of cutting tool material for your application, both wear resistance and grade toughness should be considered. The greater the wear resistance a cutting tool material exhibits, the more likely chipping or fracture is to occur. This requires more rigid machining conditions.

On the other hand, to effectively machine some materials, cobalt or carbide grades of cutting tool material may be required. The graph will aid you in the selection of a cutting tool material with the right combination of wear resistance and toughness to make your application both efficient and cost effective.

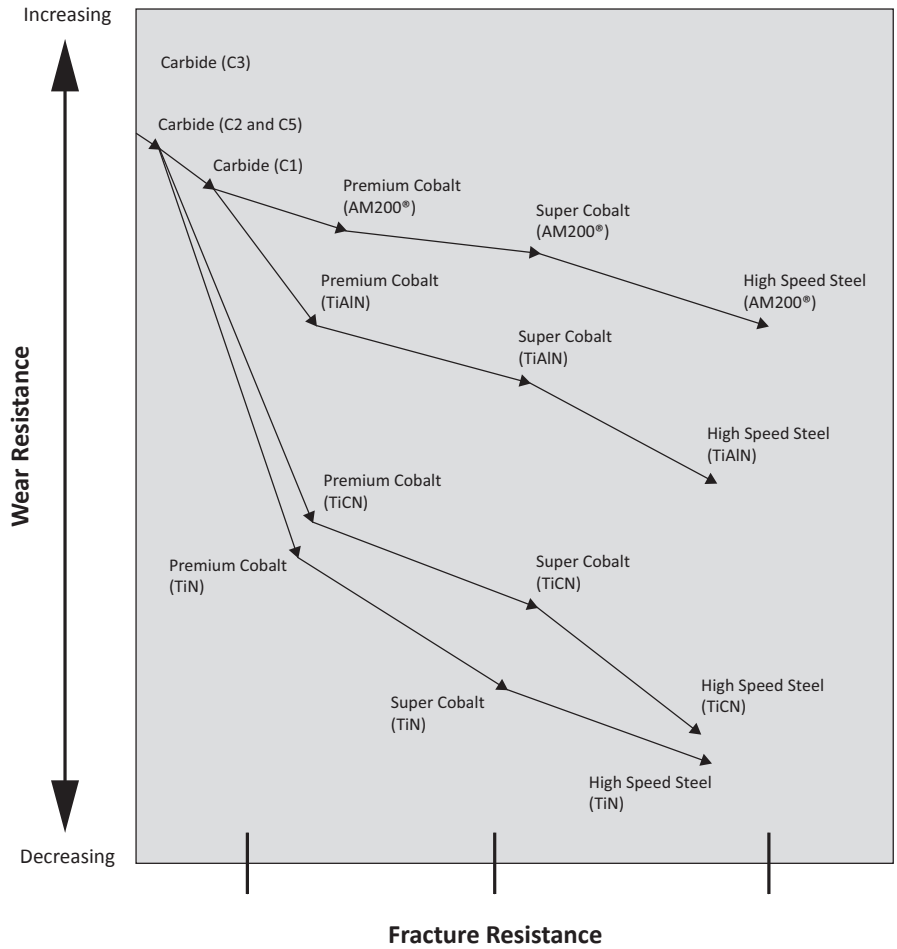

**T-A System Guidelines for Use**

- Select the shortest holder possible for the application
- Ensure the T-A holder is held securely and is within 0.003" (0.08mm) of center line
- The T-A insert should be installed in the slot of the holder using the TORX Plus screws provided. These should be tightened to the values listed on the T-A holder pages
- The holder slot should be clean from dirt or debris
- Check that the insert outer diameter is a minimum of 0.012" (0.30mm) larger than the holder body diameter
- Use the recommended cutting data section for guidance when selecting correct insert grades, along with speeds and feeds
- **NOTE:** These cutting parameters are starting conditions only and make no allowance for machine or component rigidity



## Product Nomenclature

### T-A Drill Inserts

<b>4</b>	<b>5</b>	<b>3</b>	<b>H</b>	-	<b>0115</b>
1	2	3	4		5

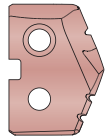

1. Insert	2. Material	3. Series	4. Coating	5. Diameter
<b>1</b> = Original T-A <b>4</b> = GEN2 T-A	<b>3</b> = HSS <b>5</b> = Super cobalt <b>8</b> = Premium cobalt <b>C1</b> = C1 (K35) carbide <b>C2</b> = C2 (K20) carbide <b>C3</b> = C3 (K10) carbide <b>C5</b> = C5 (P40) carbide	<b>Y</b> = Y series <b>4</b> = 4 series <b>Z</b> = Z series <b>5</b> = 5 series <b>0</b> = 0 series <b>6</b> = 6 series <b>1</b> = 1 series <b>7</b> = 7 series <b>2</b> = 2 series <b>8</b> = 8 series <b>3</b> = 3 series	<b>P</b> = AM300® <b>H</b> = AM200® <b>A</b> = TiAlN <b>N</b> = TiCN <b>T</b> = TiN	<b>0017</b> = Inch <b>.515</b> = Decimal <b>13</b> = Metric

### Ordering Instructions

#### ► Standard Items:

All orders are processed through Allied Machine's computerized order entry and invoicing system. Please specify the correct catalog number as well as a full description of the desired item(s) so we can process your order accurately and efficiently. Incorrect item numbers and/or descriptions will cause unnecessary delays and possible returns that are subject to a 10% restocking charge. Your assistance is critical if we are to achieve our goal of processing orders and shipping in-stock items error free within 24 hours.

#### ► Non-Standard Sizes and Geometries:

Non-standard diameter	Substitute the required diameter in place of the standard diameter. Ex: Standard item number <b>132T-0101</b> Non-standard diameter with standard geometry (inch) <b>132T-1.0200</b> (Note: 4 decimal places) Non-standard diameter with standard geometry (metric) <b>132T-34.20</b> (Note: 2 decimal places)
Special geometry	Add the special geometry code at the end of the standard item number (see pages A30: 4 - 6 for geometry options). Ex: Standard item number <b>132T-0101</b> Standard diameter with special geometry (inch) <b>132T-0101-SK</b>
Non-standard diameter with special geometry	Replace the standard diameter and add the special geometry code. Ex: Standard item number <b>132T-0101</b> Non-standard diameter with special geometry (inch) <b>132T-1.0200-SK</b> (Note: 4 decimal places)

### Reference Key

Symbol	Attribute
$D_1$	Insert diameter
$T_1$	Insert thickness

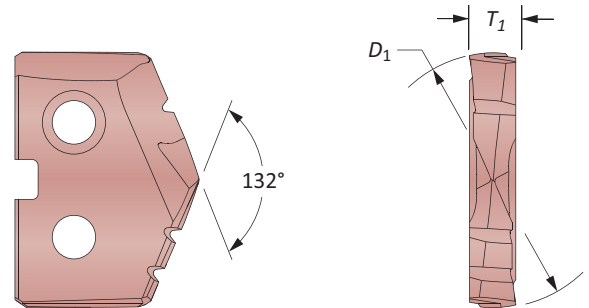

**Product Nomenclature**

**T-A Drill Holders**

<b>2</b>	<b>30</b>	<b>20</b>	<b>S</b>	-	<b>004</b>	<b>I</b>
1	2	3	4		5	6

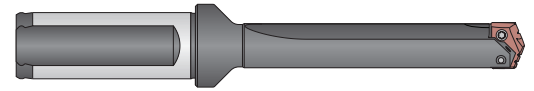

1. Holder	2. Length	3. Series	4. Flute																										
2 = T-A holder	10 = Stub 20 = Short 30 = Intermediate 40 = Standard 45 = Standard Plus 50 = Extended 60 = Long 65 = Long Plus 70 = XL 90 = 3XL	<table border="0"> <tr> <td>Y0 = Y series</td> <td>20 = 2 series</td> </tr> <tr> <td>Z0 = Z series</td> <td>25 = 2.5 series</td> </tr> <tr> <td>00 = 0 series</td> <td>30 = 3 series</td> </tr> <tr> <td>05 = 0.5 series</td> <td>40 = 4 series</td> </tr> <tr> <td>10 = 1 series</td> <td>50 = 5 series</td> </tr> <tr> <td>15 = 1.5 series</td> <td>70 = 7 series</td> </tr> </table>	Y0 = Y series	20 = 2 series	Z0 = Z series	25 = 2.5 series	00 = 0 series	30 = 3 series	05 = 0.5 series	40 = 4 series	10 = 1 series	50 = 5 series	15 = 1.5 series	70 = 7 series	S = Straight H = Helical														
Y0 = Y series	20 = 2 series																												
Z0 = Z series	25 = 2.5 series																												
00 = 0 series	30 = 3 series																												
05 = 0.5 series	40 = 4 series																												
10 = 1 series	50 = 5 series																												
15 = 1.5 series	70 = 7 series																												
5. Shank Designator	6. Shank Code																												
<table border="0"> <thead> <tr> <th>Morse Taper</th> <th>Imperial</th> <th>Metric</th> </tr> </thead> <tbody> <tr> <td>002 = 2MT</td> <td>063 = 5/8"</td> <td>16 = 16mm</td> </tr> <tr> <td>003 = 3MT</td> <td>075 = 3/4"</td> <td>20 = 20mm</td> </tr> <tr> <td>004 = 4MT</td> <td>100 = 1"</td> <td>25 = 25mm</td> </tr> <tr> <td>005 = 5MT</td> <td>125 = 1-1/4"</td> <td>32 = 32mm</td> </tr> <tr> <td></td> <td>150 = 1-1/2"</td> <td>40 = 40mm</td> </tr> <tr> <td></td> <td>175 = 1-3/4"</td> <td>50 = 50mm</td> </tr> <tr> <td></td> <td>200 = 2"</td> <td></td> </tr> <tr> <td></td> <td>300 = 3"</td> <td></td> </tr> </tbody> </table>	Morse Taper	Imperial	Metric	002 = 2MT	063 = 5/8"	16 = 16mm	003 = 3MT	075 = 3/4"	20 = 20mm	004 = 4MT	100 = 1"	25 = 25mm	005 = 5MT	125 = 1-1/4"	32 = 32mm		150 = 1-1/2"	40 = 40mm		175 = 1-3/4"	50 = 50mm		200 = 2"			300 = 3"		I = Imperial Morse taper M = Metric Morse taper L = Lathe shank F = Flanged shank FM = Flanged metric shank	
Morse Taper	Imperial	Metric																											
002 = 2MT	063 = 5/8"	16 = 16mm																											
003 = 3MT	075 = 3/4"	20 = 20mm																											
004 = 4MT	100 = 1"	25 = 25mm																											
005 = 5MT	125 = 1-1/4"	32 = 32mm																											
	150 = 1-1/2"	40 = 40mm																											
	175 = 1-3/4"	50 = 50mm																											
	200 = 2"																												
	300 = 3"																												

**Reference Key**

Symbol	Attribute
$D_2$	Shank diameter
$L_1$	Overall length
$L_2$	Drill depth
$L_3$	Holder reference length
$L_4$	Holder length
$L_7$	Shank length
$P_1$	Rear pipe tap
$P_2$	Side pipe tap
<b>RCA</b>	Corresponding RCA item number
<b>MT</b>	Morse taper size
<b>ER</b>	ER collet size

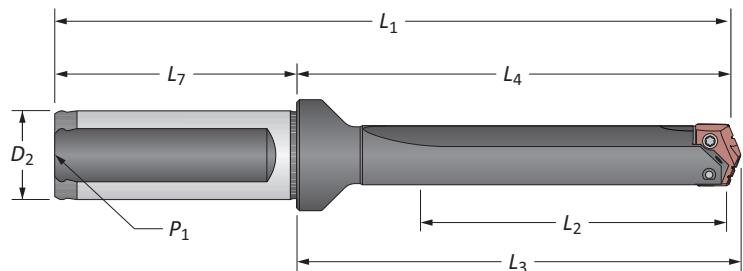

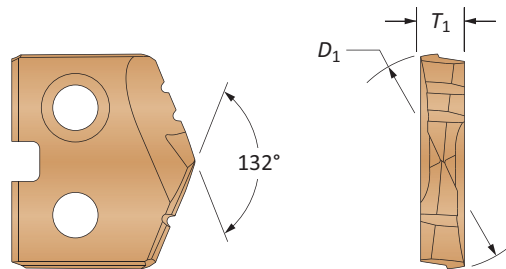

## GEN2 T-A Drill Inserts

Y Series | Diameter Range: 0.374" - 0.436" (9.5mm - 11.07mm)



HSS Inserts – Super Cobalt • Carbide Inserts – C2 (K20) | C1 (K35)

Fractional Equivalent	Insert			HSS Part No.	Carbide Part No.	
	$D_1$ inch	$D_1$ mm	$T_1$	 AM200® Super Cobalt	 AM300® C2 (K20)	 AM300® C1 (K35)
–	0.3740	9.50	3/32	45YH-9.5	4C2YP-9.5	4C1YP-9.5
3/8	0.3750	9.53	3/32	45YH-0012	4C2YP-0012	4C1YP-0012
W	0.3860	9.80	3/32	45YH-.386	4C2YP-.386	4C1YP-.386
25/64	0.3906	9.92	3/32	45YH-.390	4C2YP-.390	4C1YP-.390
–	0.3937	10.00	3/32	45YH-10	4C2YP-10	4C1YP-10
–	0.4016	10.20	3/32	45YH-10.2	4C2YP-10.2	4C1YP-10.2
13/32	0.4063	10.32	3/32	45YH-0013	4C2YP-0013	4C1YP-0013
–	0.4134	10.50	3/32	45YH-10.5	4C2YP-10.5	4C1YP-10.5
27/64	0.4219	10.72	3/32	45YH-.421	4C2YP-.421	4C1YP-.421
–	0.4252	10.80	3/32	45YH-10.8	4C2YP-10.8	4C1YP-10.8
–	0.4331	11.00	3/32	45YH-11	4C2YP-11	4C1YP-11

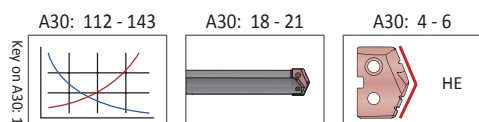

Coatings not listed above can be supplied as non-stocked standards. Process fees apply. →

TiN = 45YT-XXXX	TiAlN = 45YA-XXXX
TiCN = 45YN-XXXX	AM200® = 45YH-XXXX

Inserts sold in quantities of 2



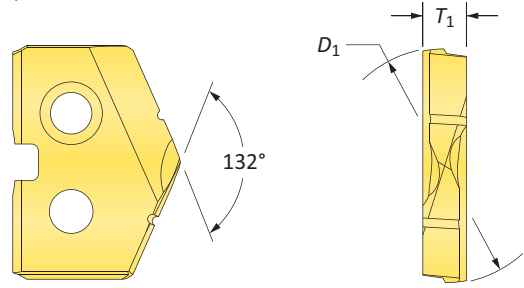
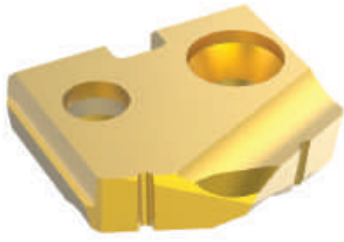

### Original T-A Drill Inserts

Y Series | HSS | Diameter Range: 0.374" - 0.436" (9.5mm - 11.07mm)



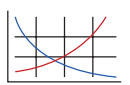

### HSS Inserts – Premium Cobalt

Fractional Equivalent	Insert			Part No.		
	$D_1$ inch	$D_1$ mm	$T_1$	 TiN	 TiAlN	 TiCN
-	0.3740	9.50	3/32	<b>18YT-9.5</b>	<b>18YA-9.5</b>	<b>18YN-9.5</b>
3/8	0.3750	9.53	3/32	<b>18YT-0012</b>	<b>18YA-0012</b>	<b>18YN-0012</b>
W	0.3860	9.80	3/32	<b>18YT-.386</b>	<b>18YA-.386</b>	<b>18YN-.386</b>
25/64	0.3906	9.92	3/32	<b>18YT-.390</b>	<b>18YA-.390</b>	<b>18YN-.390</b>
-	0.3937	10.00	3/32	<b>18YT-10</b>	<b>18YA-10</b>	<b>18YN-10</b>
-	0.4016	10.20	3/32	<b>18YT-10.2</b>	<b>18YA-10.2</b>	<b>18YN-10.2</b>
13/32	0.4063	10.32	3/32	<b>18YT-0013</b>	<b>18YA-0013</b>	<b>18YN-0013</b>
-	0.4134	10.50	3/32	<b>18YT-10.5</b>	<b>18YA-10.5</b>	<b>18YN-10.5</b>
27/64	0.4219	10.72	3/32	<b>18YT-.421</b>	<b>18YA-.421</b>	<b>18YN-.421</b>
-	0.4252	10.80	3/32	<b>18YT-10.8</b>	<b>18YA-10.8</b>	<b>18YN-10.8</b>
-	0.4331	11.00	3/32	<b>18YT-11</b>	<b>18YA-11</b>	<b>18YN-11</b>

A30: 112 - 143  Key on A30-1

A30: 18 - 21 

A30: 4 - 6  HI, HR, CR, TC, SK, NP, IN, RN, CN, AN, BR, CI, CP, NC, WC

Coatings not listed above can be supplied as non-stocked standards. Process fees apply. 

Inserts sold in quantities of 2



<b>TiN = 18YT-XXXX</b>	<b>TiAlN = 18YA-XXXX</b>
<b>TiCN = 18YN-XXXX</b>	<b>AM200® = 18YH-XXXX</b>

## Original T-A Drill Inserts

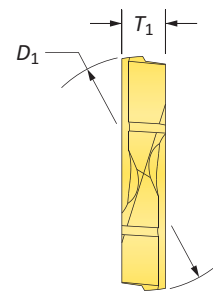
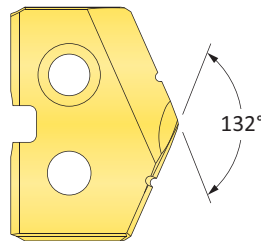
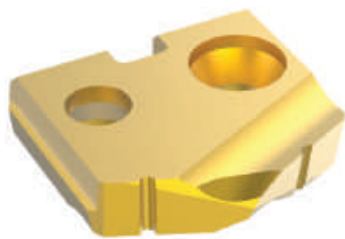
Y Series | HSS | Diameter Range: 0.374" - 0.436" (9.5mm - 11.07mm)



### HSS Inserts – Super Cobalt

Fractional Equivalent	Insert			Part No.		
	$D_1$ inch	$D_1$ mm	$T_1$	 TiN	 TiAlN	 TiCN
–	0.3740	9.50	3/32	15YT-9.5	15YA-9.5	15YN-9.5
3/8	0.3750	9.53	3/32	15YT-0012	15YA-0012	15YN-0012
W	0.3860	9.80	3/32	15YT-.386	15YA-.386	15YN-.386
25/64	0.3906	9.92	3/32	15YT-.390	15YA-.390	15YN-.390
–	0.3937	10.00	3/32	15YT-10	15YA-10	15YN-10
–	0.4016	10.20	3/32	15YT-10.2	15YA-10.2	15YN-10.2
13/32	0.4063	10.32	3/32	15YT-0013	15YA-0013	15YN-0013
–	0.4134	10.50	3/32	15YT-10.5	15YA-10.5	15YN-10.5
27/64	0.4219	10.72	3/32	15YT-.421	15YA-.421	15YN-.421
–	0.4252	10.80	3/32	15YT-10.8	15YA-10.8	15YN-10.8
–	0.4331	11.00	3/32	15YT-11	15YA-11	15YN-11

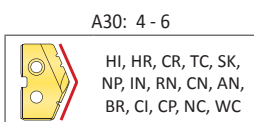
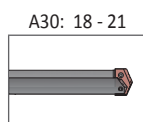
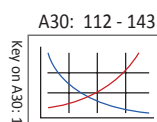

Coatings not listed above can be supplied as non-stocked standards. Process fees apply. →

TiN = 15YT-XXXX	TiAlN = 15YA-XXXX
TiCN = 15YN-XXXX	AM200® = 15YH-XXXX

Inserts sold in quantities of 2



### Original T-A Drill Inserts

Y Series | HSS | Diameter Range: 0.374" - 0.436" (9.5mm - 11.07mm)

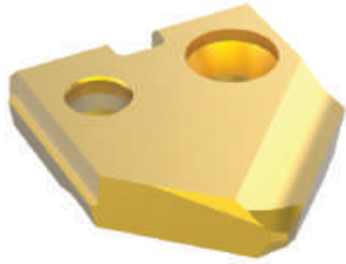



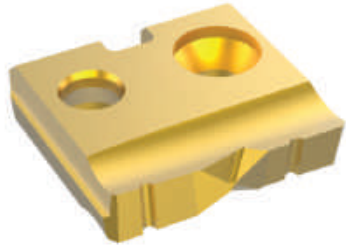
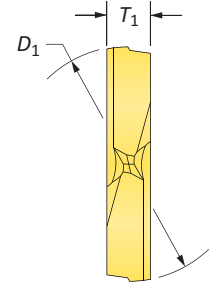
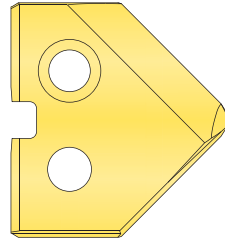

90° Spot & Chamfer

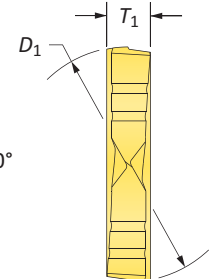
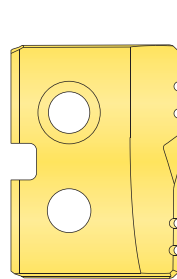

Flat Bottom



### HSS Inserts – Super Cobalt

Fractional Equivalent	Insert			90° Spot & Chamfer Part No.			Flat Bottom Part No.
	D <sub>1</sub> inch	D <sub>1</sub> mm	T <sub>1</sub>	 TiN	 TiAlN	 TiCN	 TiN
–	0.3740	9.50	3/32	15YT-9.5-SP	15YA-9.5-SP	15YN-9.5-SP	15YT-9.5-FB
3/8	0.3750	9.53	3/32	15YT-0012-SP	15YA-0012-SP	15YN-0012-SP	15YT-0012-FB
W	0.3860	9.80	3/32	15YT-.386-SP	15YA-.386-SP	15YN-.386-SP	15YT-.386-FB
25/64	0.3906	9.92	3/32	15YT-.390-SP	15YA-.390-SP	15YN-.390-SP	15YT-.390-FB
–	0.3937	10.00	3/32	15YT-10-SP	15YA-10-SP	15YN-10-SP	15YT-10-FB
–	0.4016	10.20	3/32	15YT-10.2-SP	15YA-10.2-SP	15YN-10.2-SP	15YT-10.2-FB
13/32	0.4063	10.32	3/32	15YT-0013-SP	15YA-0013-SP	15YN-0013-SP	15YT-0013-FB
–	0.4134	10.50	3/32	15YT-10.5-SP	15YA-10.5-SP	15YN-10.5-SP	15YT-10.5-FB
27/64	0.4219	10.72	3/32	15YT-.421-SP	15YA-.421-SP	15YN-.421-SP	15YT-.421-FB
–	0.4252	10.80	3/32	15YT-10.8-SP	15YA-10.8-SP	15YN-10.8-SP	15YT-10.8-FB
–	0.4331	11.00	3/32	15YT-11-SP	15YA-11-SP	15YN-11-SP	15YT-11-FB

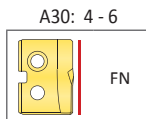
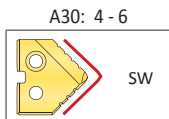
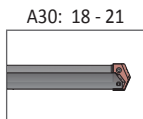
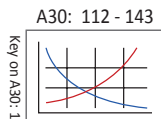

Coatings not listed above can be supplied as non-stocked standards. Process fees apply. →

TiN = 15YT-XXXX	TiAlN = 15YA-XXXX
TiCN = 15YN-XXXX	AM200® = 15YH-XXXX

Inserts sold in quantities of 2

## Original T-A Drill Inserts

Y Series | Carbide | Diameter Range: 0.374" - 0.436" (9.5mm - 11.07mm)

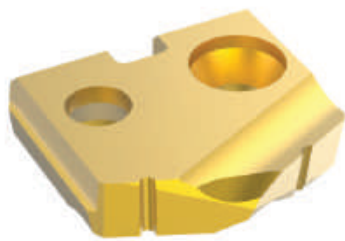

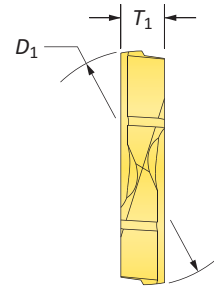
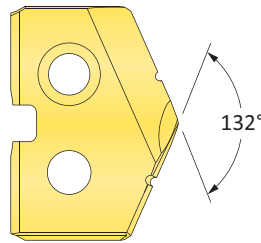

Standard

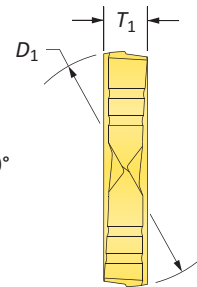
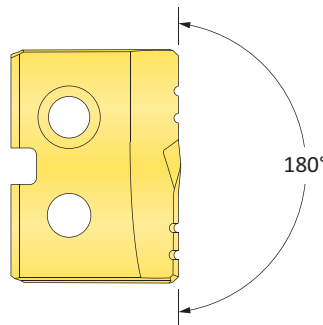

Flat Bottom



### Carbide Inserts – C2 (K20)

Fractional Equivalent	Insert			Part No.		Flat Bottom Part No.
	$D_1$ inch	$D_1$ mm	$T_1$	 TiN	 TiAlN	 TiN
-	0.3740	9.50	3/32	<b>1C2YT-9.5</b>	<b>1C2YA-9.5</b>	<b>1C2YT-9.5-FB</b>
3/8	0.3750	9.53	3/32	<b>1C2YT-0012</b>	<b>1C2YA-0012</b>	<b>1C2YT-0012-FB</b>
W	0.3860	9.80	3/32	<b>1C2YT-.386</b>	<b>1C2YA-.386</b>	<b>1C2YT-.386-FB</b>
25/64	0.3906	9.92	3/32	<b>1C2YT-.390</b>	<b>1C2YA-.390</b>	<b>1C2YT-.390-FB</b>
-	0.3937	10.00	3/32	<b>1C2YT-10</b>	<b>1C2YA-10</b>	<b>1C2YT-10-FB</b>
-	0.4016	10.20	3/32	<b>1C2YT-10.2</b>	<b>1C2YA-10.2</b>	<b>1C2YT-10.2-FB</b>
13/32	0.4063	10.32	3/32	<b>1C2YT-0013</b>	<b>1C2YA-0013</b>	<b>1C2YT-0013-FB</b>
-	0.4134	10.50	3/32	<b>1C2YT-10.5</b>	<b>1C2YA-10.5</b>	<b>1C2YT-10.5-FB</b>
27/64	0.4219	10.72	3/32	<b>1C2YT-.421</b>	<b>1C2YA-.421</b>	<b>1C2YT-.421-FB</b>
-	0.4252	10.80	3/32	<b>1C2YT-10.8</b>	<b>1C2YA-10.8</b>	<b>1C2YT-10.8-FB</b>
-	0.4331	11.00	3/32	<b>1C2YT-11</b>	<b>1C2YA-11</b>	<b>1C2YT-11-FB</b>

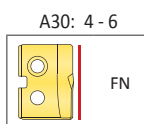
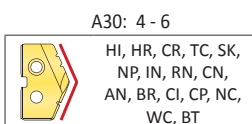
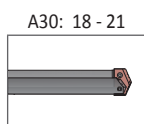
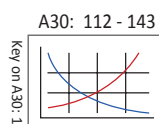

Coatings not listed above can be supplied as non-stocked standards. Process fees apply. →

TiN = 1C2YT-XXXX	TiAlN = 1C2YA-XXXX
TiCN = 1C2YN-XXXX	AM200® = 1C2YH-XXXX



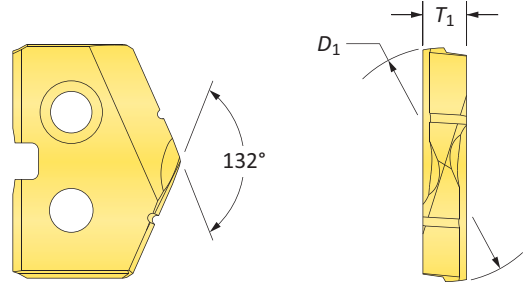
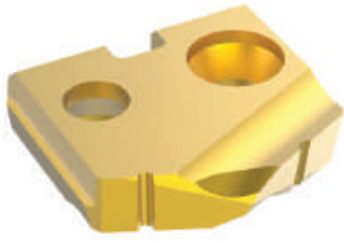

Inserts sold in quantities of 1

## Original T-A Drill Inserts

Y Series | Carbide | Diameter Range: 0.374" - 0.436" (9.5mm - 11.07mm)



Carbide Inserts – C5 (P40) | C3 (K10) | N2

Fractional Equivalent	Insert			C5 Part No.		C3 Part No.	N2 Part No.
	D <sub>1</sub> inch	D <sub>1</sub> mm	T <sub>1</sub>	 TiN	 TiAlN	 TiAlN (Cast Iron)	 Diamond Film*
-	0.3740	9.50	3/32	<b>1C5YT-9.5</b>	<b>1C5YA-9.5</b>	<b>1C3YA-9.5-CI</b>	<b>1N2YD-9.5</b>
3/8	0.3750	9.53	3/32	<b>1C5YT-0012</b>	<b>1C5YA-0012</b>	<b>1C3YA-0012-CI</b>	<b>1N2YD-0012</b>
W	0.3860	9.80	3/32	<b>1C5YT-.386</b>	<b>1C5YA-.386</b>	<b>1C3YA-.386-CI</b>	<b>1N2YD-.386</b>
25/64	0.3906	9.92	3/32	<b>1C5YT-.390</b>	<b>1C5YA-.390</b>	<b>1C3YA-.390-CI</b>	<b>1N2YD-.390</b>
-	0.3937	10.00	3/32	<b>1C5YT-10</b>	<b>1C5YA-10</b>	<b>1C3YA-10-CI</b>	<b>1N2YD-10</b>
-	0.4016	10.20	3/32	<b>1C5YT-10.2</b>	<b>1C5YA-10.2</b>	<b>1C3YA-10.2-CI</b>	<b>1N2YD-10.2</b>
13/32	0.4063	10.32	3/32	<b>1C5YT-0013</b>	<b>1C5YA-0013</b>	<b>1C3YA-0013-CI</b>	<b>1N2YD-0013</b>
-	0.4134	10.50	3/32	<b>1C5YT-10.5</b>	<b>1C5YA-10.5</b>	<b>1C3YA-10.5-CI</b>	<b>1N2YD-10.5</b>
27/64	0.4219	10.72	3/32	<b>1C5YT-.421</b>	<b>1C5YA-.421</b>	<b>1C3YA-.421-CI</b>	<b>1N2YD-.421</b>
-	0.4252	10.80	3/32	<b>1C5YT-10.8</b>	<b>1C5YA-10.8</b>	<b>1C3YA-10.8-CI</b>	<b>1N2YD-10.8</b>
-	0.4331	11.00	3/32	<b>1C5YT-11</b>	<b>1C5YA-11</b>	<b>1C3YA-11-CI</b>	<b>1N2YD-11</b>

\*Diamond Film is only available in standard geometry. For additional geometries, please contact Application Engineering.

A30: 112 - 143

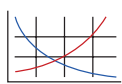

Key on A30-1

A30: 18 - 21



A30: 4 - 6



HI, HR, CR, TC, SK,  
NP, IN, RN, CN,  
AN, BR, CI, CP, NC,  
WC, BT

Coatings not listed above can be supplied as non-stocked standards. Process fees apply. →

Inserts sold in quantities of 1

<b>TiN = 1C5YT-XXXX</b>	<b>TiAlN = 1C5YA-XXXX</b>
<b>TiCN = 1C5YN-XXXX</b>	<b>AM200® = 1C5YH-XXXX</b>

## T-A Drill Insert Holders

Y Series | Flange Shank | Diameter Range: 0.374" - 0.436" (9.5mm - 11.07mm)

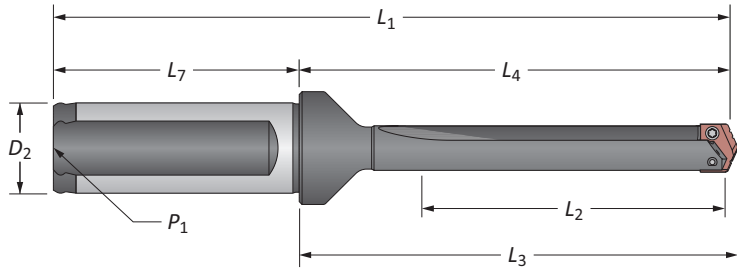

### Straight Flute

Length	Body				Shank			Part No.
	L <sub>2</sub>	L <sub>4</sub>	L <sub>3</sub>	L <sub>1</sub>	D <sub>2</sub>	L <sub>7</sub>	P <sub>1</sub>	
<b>i</b> Short	1-1/4	2-13/32	2-1/2	4-7/16	3/4	2-1/32	1/8	220Y0S-075F
<b>i</b> Standard	2-3/8	3-17/32	3-5/8	5-9/16	3/4	2-1/32	1/8	240Y0S-075F
<b>i</b> Extended	4-3/8	5-17/32	5-5/8	7-9/16	3/4	2-1/32	1/8	<b>250Y0S-075F</b>
<b>m</b> Short	31.8	61.1	63.5	111.1	20.0	50.0	1/8*	220Y0S-20FM
<b>m</b> XL	222	251.7	254.1	301.7	20.0	50.0	1/8*	<b>270Y0S-20FM</b>
<b>m</b> 3XL	290	319.9	322.3	369.9	20.0	50.0	1/8*	<b>290Y0S-20FM</b>

\*Metric thread to BSP and ISO 7-1

**NOTE:** Stub length holders have a 1/8" side pipe tap (P<sub>2</sub>)

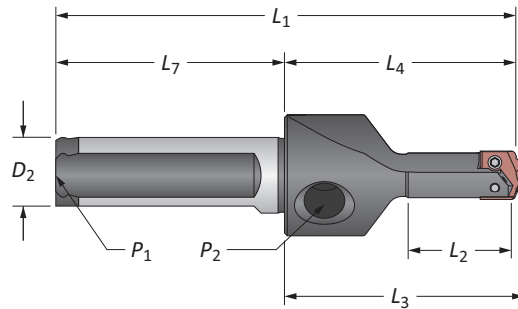

### Straight Flute (Stub Length)

Length	Body				Shank			Part No.
	L <sub>2</sub>	L <sub>4</sub>	L <sub>3</sub>	L <sub>1</sub>	D <sub>2</sub>	L <sub>7</sub>	P <sub>1</sub>	
<b>i</b> Stub	3/4	1-7/8	1-31/32	3-3/4	5/8	1-7/8	1/16	210Y0S-063F
<b>m</b> Stub	19.1	47.6	50.0	95.6	16.0	48.0	1/16*	210Y0S-16FM

\*Metric thread to BSP and ISO 7-1

**NOTE:** Stub length holders have a 1/8" side pipe tap (P<sub>2</sub>)

### Connection Accessories

Insert Screws	Nylon Locking Screws	Insert Driver	Preset Torque Hand Driver	Replacement Tips	Admissible Tightening Torque*
724-IP7-1	724N-IP7-1	8IP-7	8IP-7TL	8IP-7B	7.4 in-lbs (84 N-cm)

\*Tightening torques are calculated with a friction coefficient of  $\mu = 0.14$  and develop 90% of ultimate yield strength

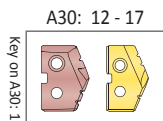

**i** = Imperial (in)  
**m** = Metric (mm)

Screws sold in quantities of 10

**WARNING** Refer to Speed and Feed charts for recommended adjustments to speeds and feeds. Refer to page A30: 146 for deep hole drilling guidelines in this section of the catalog. Visit [www.alliedmachine.com/DeepHoleGuidelines](http://www.alliedmachine.com/DeepHoleGuidelines) for the most up-to-date information and procedures. Factory technical assistance is available for your specific applications through our Application Engineering Team.

## T-A Drill Insert Holders

Y Series | Flange Shank | Diameter Range: 0.374" - 0.436" (9.5mm - 11.07mm)

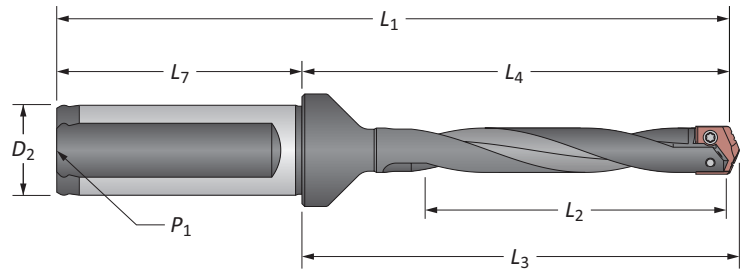





### Helical Flute

Length	Body				Shank			Part No.
	L <sub>2</sub>	L <sub>4</sub>	L <sub>3</sub>	L <sub>1</sub>	D <sub>2</sub>	L <sub>7</sub>	P <sub>1</sub>	
<b>i</b> Standard	2-3/8	3-17/32	3-5/8	5-9/16	3/4	2-1/32	1/8	240Y0H-075F
<b>i</b> Standard Plus	3-3/8	4-35/64	4-41/64	6-43/64	3/4	2-1/32	1/8	<b>⚠</b> 245Y0H-075F
<b>i</b> Extended	4-3/8	5-17/32	5-5/8	7-9/16	3/4	2-1/32	1/8	<b>⚠</b> 250Y0H-075F
<b>m</b> Standard	60.3	89.7	92.1	139.7	20.0	50.0	1/8*	240Y0H-20FM
<b>m</b> Standard Plus	86.0	115.4	117.8	165.4	20.0	50.0	1/8*	<b>⚠</b> 245Y0H-20FM
<b>m</b> Extended	111.1	140.5	142.9	190.5	20.0	50.0	1/8*	<b>⚠</b> 250Y0H-20FM

\*Metric thread to BSP and ISO 7-1

### Connection Accessories

					<b>Admissible Tightening Torque*</b>
724-IP7-1	724N-IP7-1	8IP-7	8IP-7TL	8IP-7B	7.4 in-lbs (84 N-cm)

\*Tightening torques are calculated with a friction coefficient of  $\mu = 0.14$  and develop 90% of ultimate yield strength

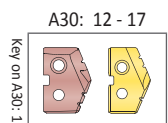

**i** = Imperial (in)  
**m** = Metric (mm)

Screws sold in quantities of 10

**⚠ WARNING** Refer to Speed and Feed charts for recommended adjustments to speeds and feeds. Refer to page A30: 146 for deep hole drilling guidelines in this section of the catalog. Visit [www.alliedmachine.com/DeepHoleGuidelines](http://www.alliedmachine.com/DeepHoleGuidelines) for the most up-to-date information and procedures. Factory technical assistance is available for your specific applications through our Application Engineering Team.

## T-A Drill Insert Holders

Y Series | Taper Shank | Diameter Range: 0.374" - 0.436" (9.5mm - 11.07mm)

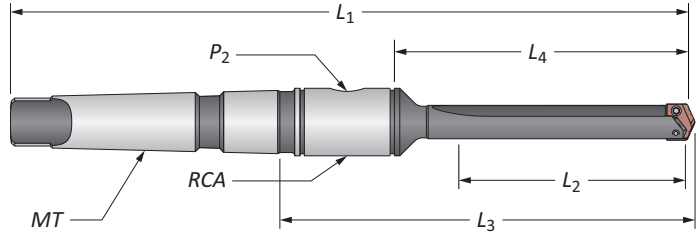

### Straight Flute

Length	Body				Shank			Part No.
	L <sub>2</sub>	L <sub>4</sub>	L <sub>3</sub>	L <sub>1</sub>	MT	P <sub>2</sub>	RCA	
Short	1-1/4	2-1/32	3-15/32	6-5/16	#2	1/16	2T-2SR	220Y0S-002I
Standard	2-3/8	3-5/32	4-19/32	7-7/16	#2	1/16	2T-2SR	240Y0S-002I
Extended	4-3/8	5-5/32	6-19/32	9-7/16	#2	1/16	2T-2SR	250Y0S-002I
Short	31.8	51.5	88.0	160.3	#2**	1/16*	2T-2SRM	220Y0S-002M

\*Metric thread to BSP and ISO 7-1

\*\*Per ISO 296 type BEK

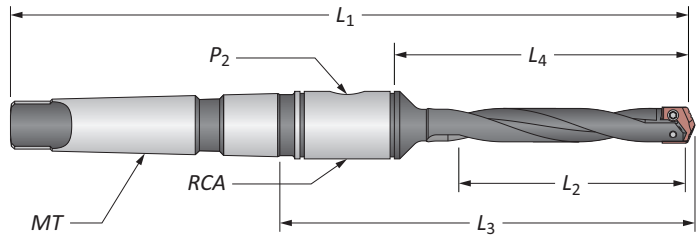

### Helical Flute

Length	Body				Shank			Part No.
	L <sub>2</sub>	L <sub>4</sub>	L <sub>3</sub>	L <sub>1</sub>	MT	P <sub>2</sub>	RCA	
Standard	2-3/8	3-5/32	4-19/32	7-7/16	#2	1/16	2T-2SR	240Y0H-002I
Extended	4-3/8	5-5/32	6-19/32	9-7/16	#2	1/16	2T-2SR	250Y0H-002I
Standard	60.3	80.2	116.7	188.9	#2**	1/16*	2T-2SRM	240Y0H-002M
Extended	111.1	130.9	167.4	239.7	#2**	1/16*	2T-2SRM	250Y0H-002M

\*Metric thread to BSP and ISO 7-1

\*\*Per ISO 296 type BEK

### Connection Accessories

Insert Screws	Nylon Locking Screws	Insert Driver	Preset Torque Hand Driver	Replacement Tips	Admissible Tightening Torque*
724-IP7-1	724N-IP7-1	8IP-7	8IP-7TL	8IP-7B	7.4 in-lbs (84 N-cm)

\*Tightening torques are calculated with a friction coefficient of  $\mu = 0.14$  and develop 90% of ultimate yield strength

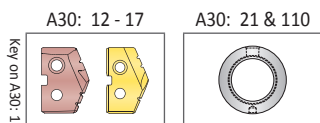

i = Imperial (in)

m = Metric (mm)

Screws sold in quantities of 10

**WARNING** Refer to Speed and Feed charts for recommended adjustments to speeds and feeds. Refer to page A30: 146 for deep hole drilling guidelines in this section of the catalog. Visit [www.alliedmachine.com/DeepHoleGuidelines](http://www.alliedmachine.com/DeepHoleGuidelines) for the most up-to-date information and procedures. Factory technical assistance is available for your specific applications through our Application Engineering Team.



## T-A Drill Insert Holders

Y Series | Straight Shank | ER Collet | Diameter Range: 0.374" - 0.436" (9.5mm - 11.07mm)

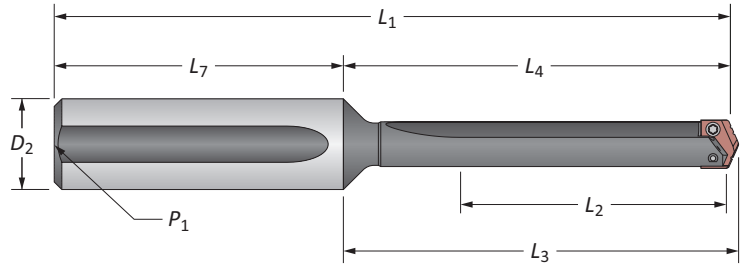

### Straight Flute

Length	Body				Shank			Part No.
	L <sub>2</sub>	L <sub>4</sub>	L <sub>3</sub>	L <sub>1</sub>	D <sub>2</sub>	L <sub>7</sub>	P <sub>1</sub>	
Short	1-1/4	2-1/32	2-1/8	4-13/32	3/4	2-3/8	1/8	220Y0S-075L
Standard	2-3/8	3-5/32	3-1/4	5-17/32	3/4	2-3/8	1/8	240Y0S-075L
Extended	4-3/8	5-5/32	5-1/4	7-17/32	3/4	2-3/8	1/8	250Y0S-075L
XL	8-3/4	9-17/32	9-5/8	11-29/32	3/4	2-3/8	1/8	270Y0S-075L
3XL	11-7/16	12-7/32	12-5/16	14-19/32	3/4	2-3/8	1/8	290Y0S-075L

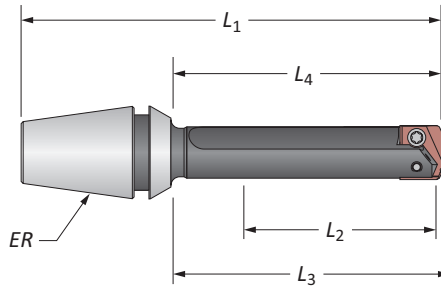

### ER Collet Holder

L <sub>2</sub>	Body				ER	Part No.	Collet Nut without Retaining Ring
	L <sub>4</sub>	L <sub>3</sub>	L <sub>1</sub>				
1-3/8	1-29/32	2	3-5/64	ER-16	210Y0S-16ER	ER-16N	
1-3/8	1-29/32	2	3-15/64	ER-20	210Y0S-20ER	ER-20N	

## T-A Drill Accessories

Y Series | Rotary Coolant Adapters | Torx® Plus Screws

### Rotary Coolant Adapter (RCA) and Accessories

ID	OD	L <sub>1</sub>	Driving Rod Thread	P <sub>1</sub>	Part No.	RCA O-Rings	
						Kit Part No.**	Replacements
3/4	1-3/4	7/8	5/16-18	1/8	2T-2SR	2T1-2SR	2T1-2OR-10
19.05	44.45	22.23	M8 x 1.25	1/8*	2T-2SRM	2T1-2SR	2T1-2OR-10

\*Thread to BSP and ISO 7-1 | \*\*RCA Repair Kit includes (2) O-rings, (2) snap rings, and (2) thrust washers

Refer to page A30: 110 for proper RCA assembly and safety information

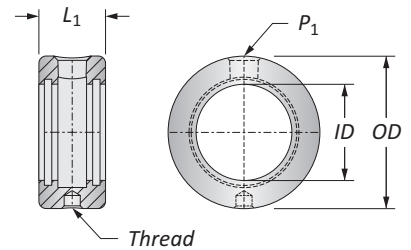

### Connection Accessories

Insert Screws	Nylon Locking Screws	Insert Driver	Preset Torque Hand Driver	Replacement Tips	Admissible Tightening Torque*
724-IP7-1	724N-IP7-1	8IP-7	8IP-7TL	8IP-7B	7.4 in-lbs (84 N-cm)

\*Tightening torques are calculated with a friction coefficient of  $\mu = 0.14$  and develop 90% of ultimate yield strength

**WARNING** Refer to Speed and Feed charts for recommended adjustments to speeds and feeds. Refer to page A30: 146 for deep hole drilling guidelines in this section of the catalog. Visit [www.alliedmachine.com/DeepHoleGuidelines](http://www.alliedmachine.com/DeepHoleGuidelines) for the most up-to-date information and procedures. Factory technical assistance is available for your specific applications through our Application Engineering Team.



ⓘ = Imperial (in)  
 ⓘ = Metric (mm)  
 Screws sold in packs of 10  
 O-rings sold in packs of 10

## GEN2 T-A Drill Inserts

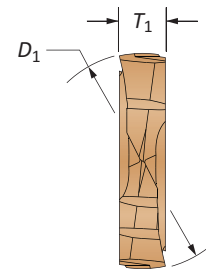
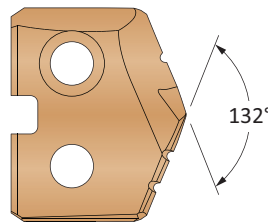
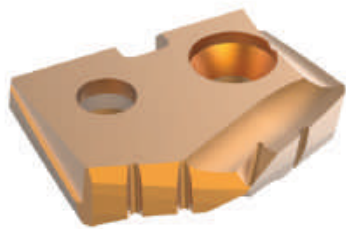
Z Series | Diameter Range: 0.437" - 0.510" (11.10mm - 12.95mm)



HSS Inserts – Super Cobalt • Carbide Inserts – C2 (K20) | C1 (K35)

Fractional Equivalent	Insert			HSS Part No.	Carbide Part No.	
	$D_1$ inch	$D_1$ mm	$T_1$	 AM200® Super Cobalt	 AM300® C2 (K20)	 AM300® C1 (K35)
7/16	0.4375	11.11	3/32	45ZH-0014	4C2ZP-0014	4C1ZP-0014
-	0.4510	11.46	3/32	45ZH-.451	4C2ZP-.451	4C1ZP-.451
-	0.4528	11.50	3/32	45ZH-11.5	4C2ZP-11.5	4C1ZP-11.5
29/64	0.4531	11.51	3/32	45ZH-.453	4C2ZP-.453	4C1ZP-.453
15/32	0.4688	11.91	3/32	45ZH-0015	4C2ZP-0015	4C1ZP-0015
-	0.4724	12.00	3/32	45ZH-12	4C2ZP-12	4C1ZP-12
31/64	0.4844	12.30	3/32	45ZH-.484	4C2ZP-.484	4C1ZP-.484
-	0.4921	12.50	3/32	45ZH-12.5	4C2ZP-12.5	4C1ZP-12.5
1/2	0.5000	12.70	3/32	45ZH-0016	4C2ZP-0016	4C1ZP-0016
-	0.5060	12.85	3/32	45ZH-.506	4C2ZP-.506	4C1ZP-.506
-	0.5100	12.95	3/32	45ZH-.510	4C2ZP-.510	4C1ZP-.510

A30: 112 - 143

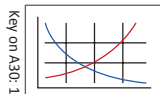

A30: 28 - 31

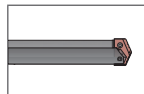

A30: 4 - 6

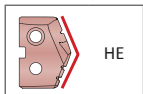

Key on A30: 1

Coatings not listed above can be supplied as non-stocked standards. Process fees apply. →

TiN = 45ZT-XXXX	TiAlN = 45ZA-XXXX
TiCN = 45ZN-XXXX	AM200® = 45ZH-XXXX

Inserts sold in quantities of 2



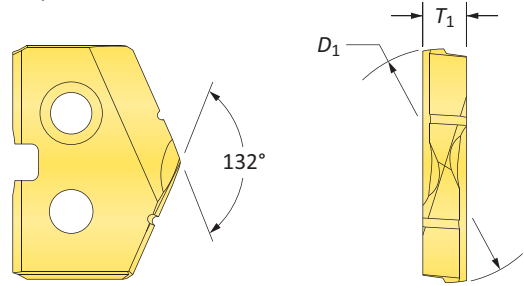

## Original T-A Drill Inserts

Z Series | HSS | Diameter Range: 0.437" - 0.510" (11.10mm - 12.95mm)



### HSS Inserts – Premium Cobalt

Fractional Equivalent	Insert			Part No.		
	$D_1$ inch	$D_1$ mm	$T_1$	 TiN	 TiAlN	 TiCN
7/16	0.4375	11.11	3/32	18ZT-0014	18ZA-0014	18ZN-0014
-	0.4510	11.46	3/32	18ZT-.451	18ZA-.451	18ZN-.451
-	0.4528	11.50	3/32	18ZT-11.5	18ZA-11.5	18ZN-11.5
29/64	0.4531	11.51	3/32	18ZT-.453	18ZA-.453	18ZN-.453
15/32	0.4688	11.91	3/32	18ZT-0015	18ZA-0015	18ZN-0015
-	0.4724	12.00	3/32	18ZT-12	18ZA-12	18ZN-12
31/64	0.4844	12.30	3/32	18ZT-.484	18ZA-.484	18ZN-.484
-	0.4921	12.50	3/32	18ZT-12.5	18ZA-12.5	18ZN-12.5
1/2	0.5000	12.70	3/32	18ZT-0016	18ZA-0016	18ZN-0016
-	0.5060	12.85	3/32	18ZT-.506	18ZA-.506	18ZN-.506
-	0.5100	12.95	3/32	18ZT-.510	18ZA-.510	18ZN-.510

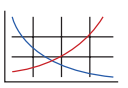
A30: 112 - 143  Key on A30-1

A30: 28 - 31 

A30: 4 - 6  HI, HR, CR, TC, SK, NP, IN, RN, CN, AN, BR, CI, CP, NC, WC

Coatings not listed above can be supplied as non-stocked standards. Process fees apply. →

Inserts sold in quantities of 2



TiN = 18ZT-XXXX	TiAlN = 18ZA-XXXX
TiCN = 18ZN-XXXX	AM200® = 18ZH-XXXX

## Original T-A Drill Inserts

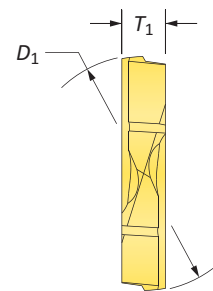
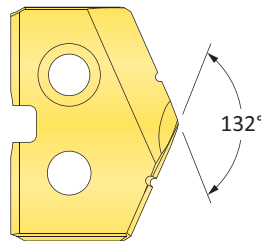
Z Series | HSS | Diameter Range: 0.437" - 0.510" (11.10mm - 12.95mm)



### HSS Inserts – Super Cobalt

Fractional Equivalent	Insert			Part No.		
	$D_1$ inch	$D_1$ mm	$T_1$	 TiN	 TiAlN	 TiCN
7/16	0.4375	11.11	3/32	<b>15ZT-0014</b>	<b>15ZA-0014</b>	<b>15ZN-0014</b>
-	0.4510	11.46	3/32	<b>15ZT-.451</b>	<b>15ZA-.451</b>	<b>15ZN-.451</b>
-	0.4528	11.50	3/32	<b>15ZT-11.5</b>	<b>15ZA-11.5</b>	<b>15ZN-11.5</b>
29/64	0.4531	11.51	3/32	<b>15ZT-.453</b>	<b>15ZA-.453</b>	<b>15ZN-.453</b>
15/32	0.4688	11.91	3/32	<b>15ZT-0015</b>	<b>15ZA-0015</b>	<b>15ZN-0015</b>
-	0.4724	12.00	3/32	<b>15ZT-12</b>	<b>15ZA-12</b>	<b>15ZN-12</b>
31/64	0.4844	12.30	3/32	<b>15ZT-.484</b>	<b>15ZA-.484</b>	<b>15ZN-.484</b>
-	0.4921	12.50	3/32	<b>15ZT-12.5</b>	<b>15ZA-12.5</b>	<b>15ZN-12.5</b>
1/2	0.5000	12.70	3/32	<b>15ZT-0016</b>	<b>15ZA-0016</b>	<b>15ZN-0016</b>
-	0.5060	12.85	3/32	<b>15ZT-.506</b>	<b>15ZA-.506</b>	<b>15ZN-.506</b>
-	0.5100	12.95	3/32	<b>15ZT-.510</b>	<b>15ZA-.510</b>	<b>15ZN-.510</b>

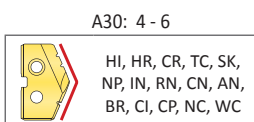
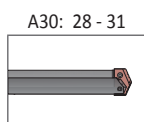
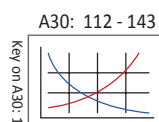

Coatings not listed above can be supplied as non-stocked standards. Process fees apply. →

<b>TiN = 15ZT-XXXX</b>	<b>TiAlN = 15ZA-XXXX</b>
<b>TiCN = 15ZN-XXXX</b>	<b>AM200® = 15ZH-XXXX</b>

Inserts sold in quantities of 2

### Original T-A Drill Inserts

Z Series | HSS | Diameter Range: 0.437" - 0.510" (11.10mm - 12.95mm)

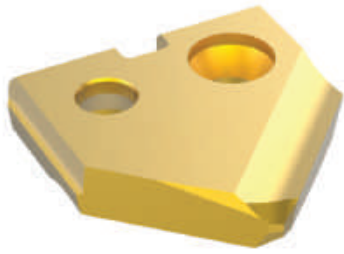



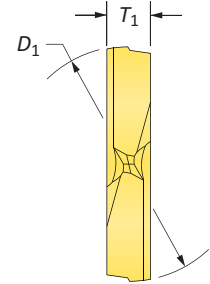
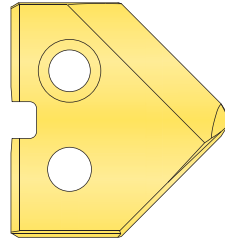

90° Spot & Chamfer

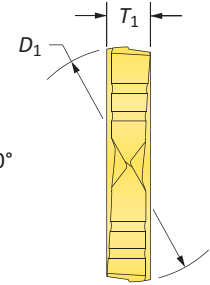
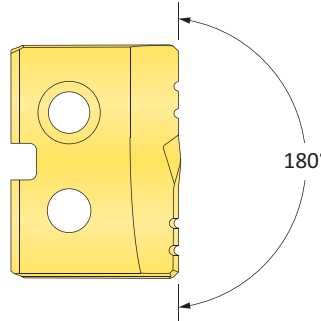

Flat Bottom



#### HSS Inserts – Super Cobalt

Fractional Equivalent	Insert			90° Spot & Chamfer Part No.			Flat Bottom Part No.
	D <sub>1</sub> inch	D <sub>1</sub> mm	T <sub>1</sub>	 TiN	 TiAlN	 TiCN	 TiN
7/16	0.4375	11.11	3/32	15ZT-0014-SP	15ZA-0014-SP	15ZN-0014-SP	15ZT-0014-FB
–	0.4510	11.46	3/32	15ZT-.451-SP	15ZA-.451-SP	15ZN-.451-SP	15ZT-.451-FB
–	0.4528	11.50	3/32	15ZT-11.5-SP	15ZA-11.5-SP	15ZN-11.5-SP	15ZT-11.5-FB
29/64	0.4531	11.51	3/32	15ZT-.453-SP	15ZA-.453-SP	15ZN-.453-SP	15ZT-.453-FB
15/32	0.4688	11.91	3/32	15ZT-0015-SP	15ZA-0015-SP	15ZN-0015-SP	15ZT-0015-FB
–	0.4724	12.00	3/32	15ZT-12-SP	15ZA-12-SP	15ZN-12-SP	15ZT-12-FB
31/64	0.4844	12.30	3/32	15ZT-.484-SP	15ZA-.484-SP	15ZN-.484-SP	15ZT-.484-FB
–	0.4921	12.50	3/32	15ZT-12.5-SP	15ZA-12.5-SP	15ZN-12.5-SP	15ZT-12.5-FB
1/2	0.5000	12.70	3/32	15ZT-0016-SP	15ZA-0016-SP	15ZN-0016-SP	15ZT-0016-FB
–	0.5060	12.85	3/32	15ZT-.506-SP	15ZA-.506-SP	15ZN-.506-SP	15ZT-.506-FB
–	0.5100	12.95	3/32	15ZT-.510-SP	15ZA-.510-SP	15ZN-.510-SP	15ZT-.510-FB

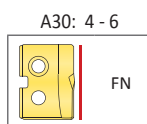
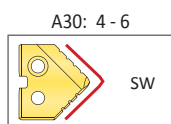
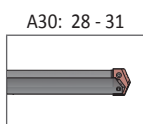
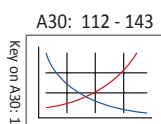

Coatings not listed above can be supplied as non-stocked standards. Process fees apply. →

TiN = 15ZT-XXXX	TiAlN = 15ZA-XXXX
TiCN = 15ZN-XXXX	AM200® = 15ZH-XXXX

Inserts sold in quantities of 2

## Original T-A Drill Inserts

Z Series | Carbide | Diameter Range: 0.437" - 0.510" (11.10mm - 12.95mm)



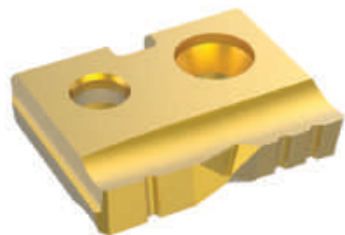
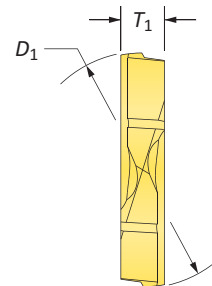
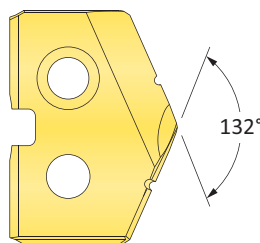

Standard

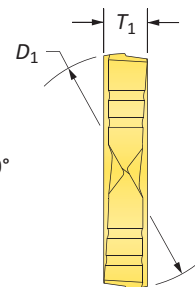
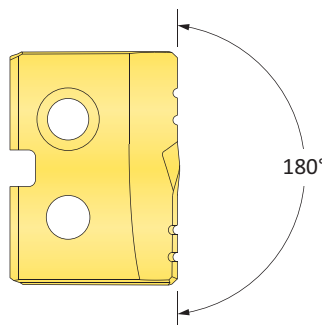

Flat Bottom



### Carbide Inserts – C2 (K20)

Fractional Equivalent	Insert			Part No.		Flat Bottom Part No.
	$D_1$ inch	$D_1$ mm	$T_1$	 TiN	 TiAlN	 TiN
7/16	0.4375	11.11	3/32	<b>1C2ZT-0014</b>	<b>1C2ZA-0014</b>	<b>1C2ZT-0014-FB</b>
-	0.4510	11.46	3/32	<b>1C2ZT-.451</b>	<b>1C2ZA-.451</b>	<b>1C2ZT-.451-FB</b>
-	0.4528	11.50	3/32	<b>1C2ZT-11.5</b>	<b>1C2ZA-11.5</b>	<b>1C2ZT-11.5-FB</b>
29/64	0.4531	11.51	3/32	<b>1C2ZT-.453</b>	<b>1C2ZA-.453</b>	<b>1C2ZT-.453-FB</b>
15/32	0.4688	11.91	3/32	<b>1C2ZT-0015</b>	<b>1C2ZA-0015</b>	<b>1C2ZT-0015-FB</b>
-	0.4724	12.00	3/32	<b>1C2ZT-12</b>	<b>1C2ZA-12</b>	<b>1C2ZT-12-FB</b>
31/64	0.4844	12.30	3/32	<b>1C2ZT-.484</b>	<b>1C2ZA-.484</b>	<b>1C2ZT-.484-FB</b>
-	0.4921	12.50	3/32	<b>1C2ZT-12.5</b>	<b>1C2ZA-12.5</b>	<b>1C2ZT-12.5-FB</b>
1/2	0.5000	12.70	3/32	<b>1C2ZT-0016</b>	<b>1C2ZA-0016</b>	<b>1C2ZT-0016-FB</b>
-	0.5060	12.85	3/32	<b>1C2ZT-.506</b>	<b>1C2ZA-.506</b>	<b>1C2ZT-.506-FB</b>
-	0.5100	12.95	3/32	<b>1C2ZT-.510</b>	<b>1C2ZA-.510</b>	<b>1C2ZT-.510-FB</b>

A30: 112 - 143

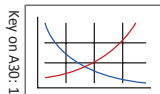

A30: 28 - 31

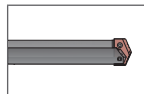

A30: 4 - 6

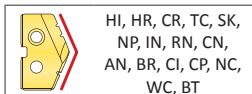

A30: 4 - 6

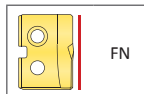

Coatings not listed above can be supplied as non-stocked standards. Process fees apply. →

TiN = 1C2ZT-XXXX

TiAlN = 1C2ZA-XXXX

TiCN = 1C2ZN-XXXX

AM200® = 1C2ZH-XXXX



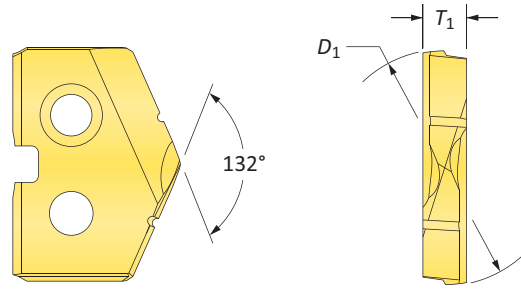

Inserts sold in quantities of 1

## Original T-A Drill Inserts

Z Series | Carbide | Diameter Range: 0.437" - 0.510" (11.10mm - 12.95mm)



Carbide Inserts – C5 (P40) | C3 (K10) | N2

Fractional Equivalent	Insert			C5 Part No.		C3 Part No.	N2 Part No.
	D <sub>1</sub> inch	D <sub>1</sub> mm	T <sub>1</sub>	 TiN	 TiAlN	 TiAlN (Cast Iron)	 Diamond Film*
7/16	0.4375	11.11	3/32	<b>1C5ZT-0014</b>	<b>1C5ZA-0014</b>	<b>1C3ZA-0014-CI</b>	<b>1N2ZD-0014</b>
-	0.4510	11.46	3/32	<b>1C5ZT-.451</b>	<b>1C5ZA-.451</b>	<b>1C3ZA-.451-CI</b>	<b>1N2ZD-.451</b>
-	0.4528	11.50	3/32	<b>1C5ZT-11.5</b>	<b>1C5ZA-11.5</b>	<b>1C3ZA-11.5-CI</b>	<b>1N2ZD-11.5</b>
29/64	0.4531	11.51	3/32	<b>1C5ZT-.453</b>	<b>1C5ZA-.453</b>	<b>1C3ZA-.453-CI</b>	<b>1N2ZD-.453</b>
15/32	0.4688	11.91	3/32	<b>1C5ZT-0015</b>	<b>1C5ZA-0015</b>	<b>1C3ZA-0015-CI</b>	<b>1N2ZD-0015</b>
-	0.4724	12.00	3/32	<b>1C5ZT-12</b>	<b>1C5ZA-12</b>	<b>1C3ZA-12-CI</b>	<b>1N2ZD-12</b>
31/64	0.4844	12.30	3/32	<b>1C5ZT-.484</b>	<b>1C5ZA-.484</b>	<b>1C3ZA-.484-CI</b>	<b>1N2ZD-.484</b>
-	0.4921	12.50	3/32	<b>1C5ZT-12.5</b>	<b>1C5ZA-12.5</b>	<b>1C3ZA-12.5-CI</b>	<b>1N2ZD-12.5</b>
1/2	0.5000	12.70	3/32	<b>1C5ZT-0016</b>	<b>1C5ZA-0016</b>	<b>1C3ZA-0016-CI</b>	<b>1N2ZD-0016</b>
-	0.5060	12.85	3/32	<b>1C5ZT-.506</b>	<b>1C5ZA-.506</b>	<b>1C3ZA-.506-CI</b>	<b>1N2ZD-.506</b>
-	0.5100	12.95	3/32	<b>1C5ZT-.510</b>	<b>1C5ZA-.510</b>	<b>1C3ZA-.510-CI</b>	<b>1N2ZD-.510</b>

\*Diamond Film is only available in standard geometry. For additional geometries, please contact Application Engineering.

A30: 112 - 143

Key on A30-1

A30: 28 - 31

A30: 4 - 6

HI, HR, CR, TC, SK,  
NP, IN, RN, CN,  
AN, BR, CI, CP, NC,  
WC, BT

Coatings not listed above can be supplied as non-stocked standards. Process fees apply. →

Inserts sold in quantities of 1

<b>TiN = 1C5ZT-XXXX</b>	<b>TiAlN = 1C5ZA-XXXX</b>
<b>TiCN = 1C5ZN-XXXX</b>	<b>AM200® = 1C5ZH-XXXX</b>

## T-A Drill Insert Holders

Z Series | Flange Shank | Diameter Range: 0.437" - 0.510" (11.10mm - 12.95mm)

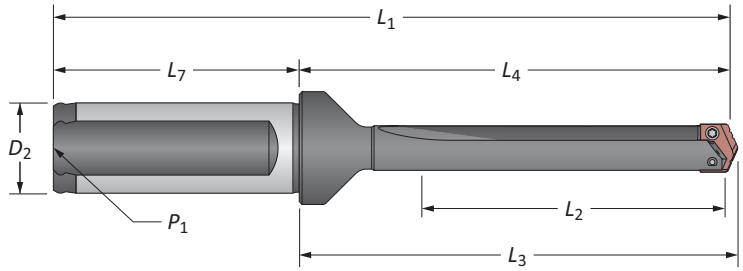

### Straight Flute

Length	Body				Shank			Part No.
	L <sub>2</sub>	L <sub>4</sub>	L <sub>3</sub>	L <sub>1</sub>	D <sub>2</sub>	L <sub>7</sub>	P <sub>1</sub>	
<b>i</b> Short	1-1/4	2-13/32	2-1/2	4-7/16	3/4	2-1/32	1/8	220Z0S-075F
<b>i</b> Standard	2-3/8	3-17/32	3-5/8	5-9/16	3/4	2-1/32	1/8	240Z0S-075F
<b>i</b> Extended	4-3/8	5-17/32	5-5/8	7-9/16	3/4	2-1/32	1/8	▲ 250Z0S-075F
<b>m</b> Short	31.8	61.1	63.5	111.1	20.0	50.0	1/8*	220Z0S-20FM
<b>m</b> XL	222.3	251.7	254.1	301.7	20.0	50.0	1/8*	▲ 270Z0S-20FM
<b>m</b> 3XL	290.5	319.9	322.3	369.9	20.0	50.0	1/8*	▲ 290Z0S-20FM

\*Metric thread to BSP and ISO 7-1

**NOTE:** Stub length holders have a 1/8" side pipe tap (P<sub>2</sub>)

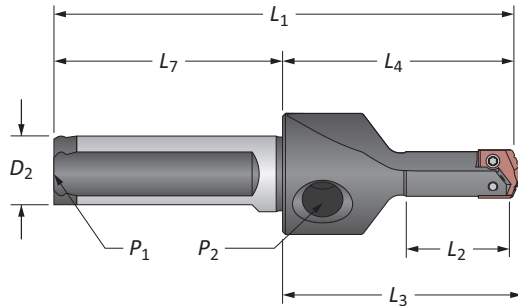

### Straight Flute (Stub Length)

Length	Body				Shank			Part No.
	L <sub>2</sub>	L <sub>4</sub>	L <sub>3</sub>	L <sub>1</sub>	D <sub>2</sub>	L <sub>7</sub>	P <sub>1</sub>	
<b>i</b> Stub	3/4	1-7/8	1-31/32	3-3/4	5/8	1-7/8	1/16	210Z0S-063F
<b>m</b> Stub	19.1	47.6	50.0	95.6	16.0	48.0	1/16*	210Z0S-16FM

\*Metric thread to BSP and ISO 7-1

**NOTE:** Stub length holders have a 1/8" side pipe tap (P<sub>2</sub>)

### Connection Accessories

Insert Screws	Nylon Locking Screws	Insert Driver	Preset Torque Hand Driver	Replacement Tips	Admissible Tightening Torque*
7247-IP7-1	7247N-IP7-1	8IP-7	8IP-7TL	8IP-7B	7.4 in-lbs (84 N-cm)

\*Tightening torques are calculated with a friction coefficient of  $\mu = 0.14$  and develop 90% of ultimate yield strength

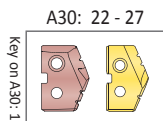

**i** = Imperial (in)  
**m** = Metric (mm)

Screws sold in quantities of 10

**WARNING** Refer to Speed and Feed charts for recommended adjustments to speeds and feeds. Refer to page A30: 146 for deep hole drilling guidelines in this section of the catalog. Visit [www.alliedmachine.com/DeepHoleGuidelines](http://www.alliedmachine.com/DeepHoleGuidelines) for the most up-to-date information and procedures. Factory technical assistance is available for your specific applications through our Application Engineering Team.





## T-A Drill Insert Holders

Z Series | Flange Shank | Diameter Range: 0.437" - 0.510" (11.10mm - 12.95mm)

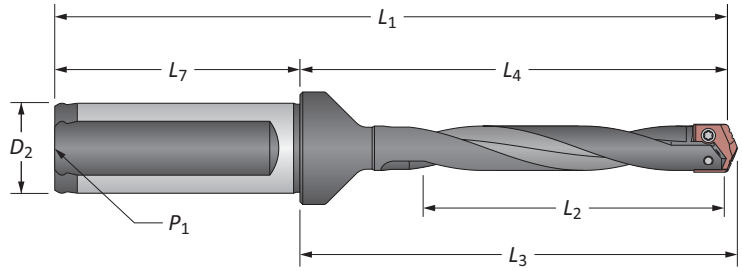

### Helical Flute

	Length	Body				Shank			Part No.
		L <sub>2</sub>	L <sub>4</sub>	L <sub>3</sub>	L <sub>1</sub>	D <sub>2</sub>	L <sub>7</sub>	P <sub>1</sub>	
i	Standard	2-3/8	3-17/32	3-5/8	5-9/16	3/4	2-1/32	1/8	240Z0H-075F
	Standard Plus	3-3/8	4-35/64	4-41/64	6-43/64	3/4	2-1/32	1/8	245Z0H-075F
	Extended	4-3/8	5-17/32	5-5/8	7-9/16	3/4	2-1/32	1/8	⚠ 250Z0H-075F
	Long	7-1/16	8-1/4	8-11/32	10-3/8	3/4	2-1/32	1/8	⚠ 260Z0H-075F
m	Standard	60.3	89.7	92.1	139.7	20.0	50.0	1/8*	240Z0H-20FM
	Standard Plus	86.0	115.4	117.8	165.4	20.0	50.0	1/8*	245Z0H-20FM
	Extended	111.1	140.5	142.9	190.5	20.0	50.0	1/8*	⚠ 250Z0H-20FM
	Long	180.0	209.4	211.8	259.4	20.0	50.0	1/8*	⚠ 260Z0H-20FM

\*Metric thread to BSP and ISO 7-1

### Connection Accessories

Insert Screws	Nylon Locking Screws	Insert Driver	Preset Torque Hand Driver	Replacement Tips	Admissible Tightening Torque*
7247-IP7-1	7247N-IP7-1	8IP-7	8IP-7TL	8IP-7B	7.4 in-lbs (84 N-cm)

\*Tightening torques are calculated with a friction coefficient of  $\mu = 0.14$  and develop 90% of ultimate yield strength

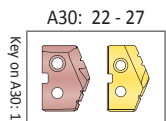

i = Imperial (in)  
m = Metric (mm)

Screws sold in quantities of 10

**⚠ WARNING** Refer to Speed and Feed charts for recommended adjustments to speeds and feeds. Refer to page A30: 146 for deep hole drilling guidelines in this section of the catalog. Visit [www.alliedmachine.com/DeepHoleGuidelines](http://www.alliedmachine.com/DeepHoleGuidelines) for the most up-to-date information and procedures. Factory technical assistance is available for your specific applications through our Application Engineering Team.

## T-A Drill Insert Holders

Z Series | Taper Shank | Diameter Range: 0.437" - 0.510" (11.10mm - 12.95mm)

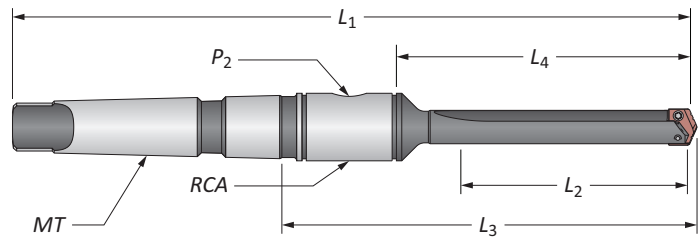

### Straight Flute

Length	Body				Shank			Part No.
	L <sub>2</sub>	L <sub>4</sub>	L <sub>3</sub>	L <sub>1</sub>	MT	P <sub>2</sub>	RCA	
Short	1-1/4	2-1/32	3-15/32	6-5/16	#2	1/16	2T-2SR	220Z0S-002I
Standard	2-3/8	3-5/32	4-19/32	7-7/16	#2	1/16	2T-2SR	240Z0S-002I
Extended	4-3/8	5-5/32	6-19/32	9-7/16	#2	1/16	2T-2SR	250Z0S-002I
Short	31.8	51.5	88.0	160.3	#2**	1/16*	2T-2SRM	220Z0S-002M

\*Metric thread to BSP and ISO 7-1

\*\*Per ISO 296 type BEK

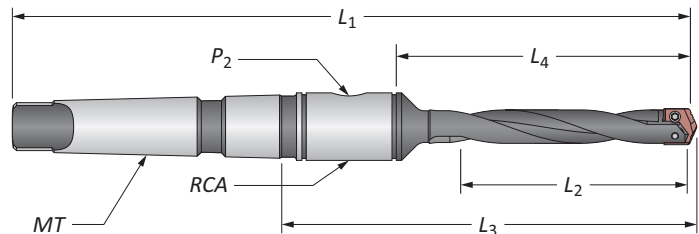

### Helical Flute

Length	Body				Shank			Part No.
	L <sub>2</sub>	L <sub>4</sub>	L <sub>3</sub>	L <sub>1</sub>	MT	P <sub>2</sub>	RCA	
Standard	2-3/8	3-5/32	4-19/32	7-7/16	#2	1/16	2T-2SR	240Z0H-002I
Extended	4-3/8	5-5/32	6-19/32	9-7/16	#2	1/16	2T-2SR	250Z0H-002I
Standard	60.3	80.2	116.7	188.9	#2**	1/16*	2T-2SRM	240Z0H-002M
Extended	111.1	130.9	167.4	239.7	#2**	1/16*	2T-2SRM	250Z0H-002M

\*Metric thread to BSP and ISO 7-1

\*\*Per ISO 296 type BEK

### Connection Accessories

Insert Screws	Nylon Locking Screws	Insert Driver	Preset Torque Hand Driver	Replacement Tips	Admissible Tightening Torque*
7247-IP7-1	7247N-IP7-1	8IP-7	8IP-7TL	8IP-7B	7.4 in-lbs (84 N-cm)

\*Tightening torques are calculated with a friction coefficient of  $\mu = 0.14$  and develop 90% of ultimate yield strength

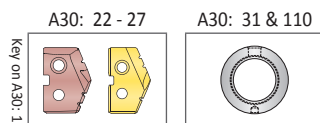

i = Imperial (in)

m = Metric (mm)

Screws sold in quantities of 10

**WARNING** Refer to Speed and Feed charts for recommended adjustments to speeds and feeds. Refer to page A30: 146 for deep hole drilling guidelines in this section of the catalog. Visit [www.alliedmachine.com/DeepHoleGuidelines](http://www.alliedmachine.com/DeepHoleGuidelines) for the most up-to-date information and procedures. Factory technical assistance is available for your specific applications through our Application Engineering Team.



## T-A Drill Insert Holders

Z Series | Straight Shank | ER Collet | Diameter Range: 0.437" - 0.510" (11.10mm - 12.95mm)

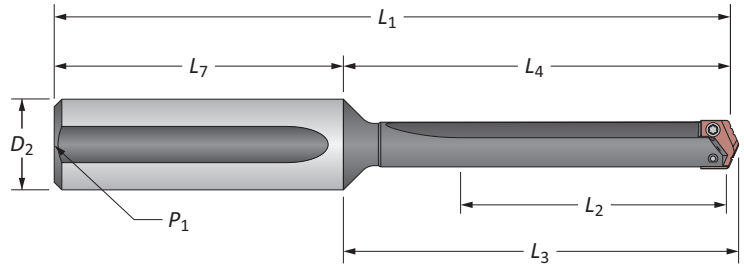

### Straight Flute

Length	Body				Shank			Part No.
	L <sub>2</sub>	L <sub>4</sub>	L <sub>3</sub>	L <sub>1</sub>	D <sub>2</sub>	L <sub>7</sub>	P <sub>1</sub>	
Short	1-1/4	2-1/32	2-1/8	4-13/32	3/4	2-3/8	1/8	220Z0S-075L
Standard	2-3/8	3-5/32	3-1/4	5-17/32	3/4	2-3/8	1/8	240Z0S-075L
Extended	4-3/8	5-5/32	5-1/4	7-17/32	3/4	2-3/8	1/8	250Z0S-075L
XL	8-3/4	9-17/32	9-5/8	11-29/32	3/4	2-3/8	1/8	270Z0S-075L
3XL	11-7/16	12-7/32	12-5/16	14-19/32	3/4	2-3/8	1/8	290Z0S-075L

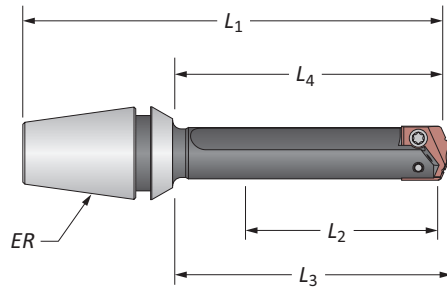

### ER Collet Holder

Length	Body				ER	Part No.	Collet Nut without Retaining Ring
	L <sub>2</sub>	L <sub>4</sub>	L <sub>3</sub>	L <sub>1</sub>			
1-3/8	1-29/32	2	3-5/64	ER-16	210Z0S-16ER	ER-16N	
1-3/8	1-29/32	2	3-15/64	ER-20	210Z0S-20ER	ER-20N	

## T-A Drill Accessories

Z Series | Rotary Coolant Adapters | Torx® Plus Screws

### Rotary Coolant Adapter (RCA) and Accessories

ID	OD	L <sub>1</sub>	Driving Rod Thread	P <sub>1</sub>	Part No.	RCA O-Rings	
						Kit Part No.**	Replacements
3/4	1-3/4	7/8	5/16-18	1/8	2T-2SR	2T1-2SR	2T1-2OR-10
19.05	44.45	22.23	M8 x 1.25	1/8*	2T-2SRM	2T1-2SR	2T1-2OR-10

\*Thread to BSP and ISO 7-1 | \*\*RCA Repair Kit includes (2) O-rings, (2) snap rings, and (2) thrust washers

Refer to page A30: 110 for proper RCA assembly and safety information

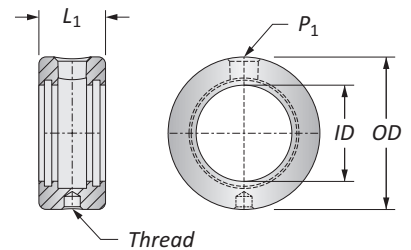

### Connection Accessories

Insert Screws	Nylon Locking Screws	Insert Driver	Preset Torque Hand Driver	Replacement Tips	Admissible Tightening Torque*
7247-IP7-1	7247N-IP7-1	8IP-7	8IP-7TL	8IP-7B	7.4 in-lbs (84 N-cm)

\*Tightening torques are calculated with a friction coefficient of  $\mu = 0.14$  and develop 90% of ultimate yield strength

**WARNING** Refer to Speed and Feed charts for recommended adjustments to speeds and feeds. Refer to page A30: 146 for deep hole drilling guidelines in this section of the catalog. Visit [www.alliedmachine.com/DeepHoleGuidelines](http://www.alliedmachine.com/DeepHoleGuidelines) for the most up-to-date information and procedures. Factory technical assistance is available for your specific applications through our Application Engineering Team.



ⓘ = Imperial (in)  
 ⓘ = Metric (mm)  
 Screws sold in packs of 10  
 O-rings sold in packs of 10

## GEN2 T-A Drill Inserts

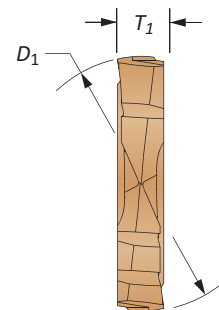
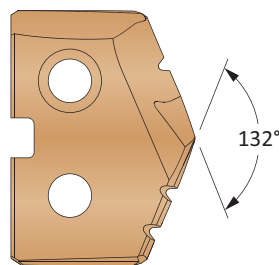
0 Series | Diameter Range: 0.511" - 0.695" (12.98mm - 17.65mm)



HSS Inserts – Super Cobalt • Carbide Inserts – C2 (K20) | C1 (K35)

Series	Fractional Equivalent	Insert			HSS Part No.	Carbide Part No.	
		$D_1$ inch	$D_1$ mm	$T_1$	 AM200® Super Cobalt	 AM300® C2 (K20)	 AM300® C1 (K35)
0	–	0.5118	13.00	1/8	450H-13	4C20P-13	4C10P-13
	33/64	0.5156	13.10	1/8	450H-.515	4C20P-.515	4C10P-.515
	17/32	0.5313	13.49	1/8	450H-0017	4C20P-0017	4C10P-0017
	–	0.5315	13.50	1/8	450H-13.5	4C20P-13.5	4C10P-13.5
	35/64	0.5469	13.89	1/8	450H-.546	4C20P-.546	4C10P-.546
	–	0.5512	14.00	1/8	450H-14	4C20P-14	4C10P-14
	9/16	0.5625	14.29	1/8	450H-0018	4C20P-0018	4C10P-0018
	–	0.5709	14.50	1/8	450H-14.5	4C20P-14.5	4C10P-14.5
	37/64	0.5781	14.68	1/8	450H-.578	4C20P-.578	4C10P-.578
	–	0.5906	15.00	1/8	450H-15	4C20P-15	4C10P-15
0.5	19/32	0.5938	15.08	1/8	450H-0019	4C20P-0019	4C10P-0019
	39/64	0.6094	15.48	1/8	450H-.609	4C20P-.609	4C10P-.609
	–	0.6102	15.50	1/8	450H-15.5	4C20P-15.5	4C10P-15.5
	5/8	0.6250	15.88	1/8	450H-0020	4C20P-0020	4C10P-0020
	–	0.6299	16.00	1/8	450H-16	4C20P-16	4C10P-16
	41/64	0.6406	16.27	1/8	450H-.640	4C20P-.640	4C10P-.640
	–	0.6496	16.50	1/8	450H-16.5	4C20P-16.5	4C10P-16.5
	21/32	0.6563	16.67	1/8	450H-0021	4C20P-0021	4C10P-0021
	–	0.6693	17.00	1/8	450H-17	4C20P-17	4C10P-17
	43/64	0.6719	17.07	1/8	450H-.671	4C20P-.671	4C10P-.671
11/16	0.6875	17.46	1/8	450H-0022	4C20P-0022	4C10P-0022	
–	0.6890	17.50	1/8	450H-17.5	4C20P-17.5	4C10P-17.5	

**NOTE:** 0.5 series inserts fit into both 0 and 0.5 series holders. However, 0 series inserts ONLY fit into 0 series holders. See page A30: 7 for visual.

A30: 112 - 143

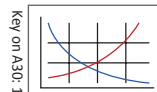

A30: 38 - 42

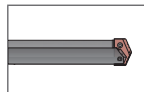

A30: 4 - 6



HE

Coatings not listed above can be supplied as non-stocked standards. Process fees apply. →

TiN = 450T-XXXX

TiAlN = 450A-XXXX

TiCN = 450N-XXXX

AM200® = 450H-XXXX



Inserts sold in quantities of 2

## Original T-A Drill Inserts

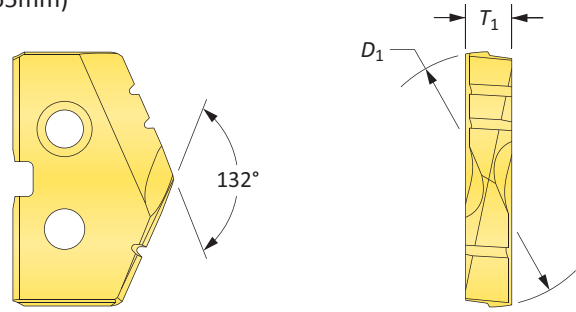
0 Series | HSS | Diameter Range: 0.511" - 0.695" (12.98mm - 17.65mm)



### HSS Inserts – Premium Cobalt

Series	Fractional Equivalent	Insert			Part No.		
		$D_1$ inch	$D_1$ mm	$T_1$	 TiN	 TiAlN	 TiCN
0	–	0.5118	13.00	1/8	<b>180T-13</b>	<b>180A-13</b>	<b>180N-13</b>
	33/64	0.5156	13.10	1/8	<b>180T-.515</b>	<b>180A-.515</b>	<b>180N-.515</b>
	17/32	0.5313	13.49	1/8	<b>180T-0017</b>	<b>180A-0017</b>	<b>180N-0017</b>
	–	0.5315	13.50	1/8	<b>180T-13.5</b>	<b>180A-13.5</b>	<b>180N-13.5</b>
	35/64	0.5469	13.89	1/8	<b>180T-.546</b>	<b>180A-.546</b>	<b>180N-.546</b>
	–	0.5512	14.00	1/8	<b>180T-14</b>	<b>180A-14</b>	<b>180N-14</b>
	9/16	0.5625	14.29	1/8	<b>180T-0018</b>	<b>180A-0018</b>	<b>180N-0018</b>
	–	0.5709	14.50	1/8	<b>180T-14.5</b>	<b>180A-14.5</b>	<b>180N-14.5</b>
	37/64	0.5781	14.68	1/8	<b>180T-.578</b>	<b>180A-.578</b>	<b>180N-.578</b>
0.5	–	0.5906	15.00	1/8	<b>180T-15</b>	<b>180A-15</b>	<b>180N-15</b>
	19/32	0.5938	15.08	1/8	<b>180T-0019</b>	<b>180A-0019</b>	<b>180N-0019</b>
	39/64	0.6094	15.48	1/8	<b>180T-.609</b>	<b>180A-.609</b>	<b>180N-.609</b>
	–	0.6102	15.50	1/8	<b>180T-15.5</b>	<b>180A-15.5</b>	<b>180N-15.5</b>
	5/8	0.6250	15.88	1/8	<b>180T-0020</b>	<b>180A-0020</b>	<b>180N-0020</b>
	–	0.6299	16.00	1/8	<b>180T-16</b>	<b>180A-16</b>	<b>180N-16</b>
	41/64	0.6406	16.27	1/8	<b>180T-.640</b>	<b>180A-.640</b>	<b>180N-.640</b>
	–	0.6496	16.50	1/8	<b>180T-16.5</b>	<b>180A-16.5</b>	<b>180N-16.5</b>
	21/32	0.6563	16.67	1/8	<b>180T-0021</b>	<b>180A-0021</b>	<b>180N-0021</b>
	–	0.6693	17.00	1/8	<b>180T-17</b>	<b>180A-17</b>	<b>180N-17</b>
	43/64	0.6719	17.07	1/8	<b>180T-.671</b>	<b>180A-.671</b>	<b>180N-.671</b>
	11/16	0.6875	17.46	1/8	<b>180T-0022</b>	<b>180A-0022</b>	<b>180N-0022</b>
–	0.6890	17.50	1/8	<b>180T-17.5</b>	<b>180A-17.5</b>	<b>180N-17.5</b>	

**NOTE:** 0.5 series inserts fit into both 0 and 0.5 series holders. However, 0 series inserts ONLY fit into 0 series holders. See page A30: 7 for visual.

A30: 112 - 143

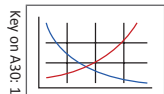

A30: 38 - 42

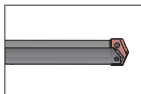

A30: 4 - 6

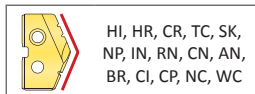

Coatings not listed above can be supplied as non-stocked standards. Process fees apply. 

Inserts sold in quantities of 2



<b>TiN = 180T-XXXX</b>	<b>TiAlN = 180A-XXXX</b>
<b>TiCN = 180N-XXXX</b>	<b>AM200® = 180H-XXXX</b>

## Original T-A Drill Inserts

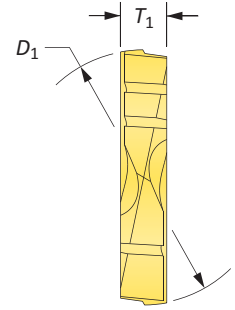
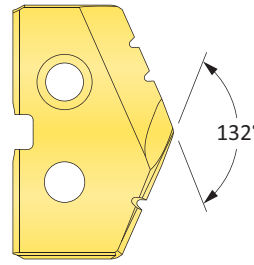
0 Series | HSS | Diameter Range: 0.511" - 0.695" (12.98mm - 17.65mm)



### HSS Inserts – Super Cobalt

Series	Fractional Equivalent	Insert			Part No.		
		$D_1$ inch	$D_1$ mm	$T_1$	 TiN	 TiAlN	 TiCN
0	-	0.5118	13.00	1/8	150T-13	150A-13	150N-13
	33/64	0.5156	13.10	1/8	150T-.515	150A-.515	150N-.515
	17/32	0.5313	13.49	1/8	150T-0017	150A-0017	150N-0017
	-	0.5315	13.50	1/8	150T-13.5	150A-13.5	150N-13.5
	35/64	0.5469	13.89	1/8	150T-.546	150A-.546	150N-.546
	-	0.5512	14.00	1/8	150T-14	150A-14	150N-14
	9/16	0.5625	14.29	1/8	150T-0018	150A-0018	150N-0018
	-	0.5709	14.50	1/8	150T-14.5	150A-14.5	150N-14.5
	37/64	0.5781	14.68	1/8	150T-.578	150A-.578	150N-.578
	-	0.5906	15.00	1/8	150T-15	150A-15	150N-15
19/32	0.5938	15.08	1/8	150T-0019	150A-0019	150N-0019	
0.5	39/64	0.6094	15.48	1/8	150T-.609	150A-.609	150N-.609
	-	0.6102	15.50	1/8	150T-15.5	150A-15.5	150N-15.5
	5/8	0.6250	15.88	1/8	150T-0020	150A-0020	150N-0020
	-	0.6299	16.00	1/8	150T-16	150A-16	150N-16
	41/64	0.6406	16.27	1/8	150T-.640	150A-.640	150N-.640
	-	0.6496	16.50	1/8	150T-16.5	150A-16.5	150N-16.5
	21/32	0.6563	16.67	1/8	150T-0021	150A-0021	150N-0021
	-	0.6693	17.00	1/8	150T-17	150A-17	150N-17
	43/64	0.6719	17.07	1/8	150T-.671	150A-.671	150N-.671
	11/16	0.6875	17.46	1/8	150T-0022	150A-0022	150N-0022
-	0.6890	17.50	1/8	150T-17.5	150A-17.5	150N-17.5	

**NOTE:** 0.5 series inserts fit into both 0 and 0.5 series holders. However, 0 series inserts ONLY fit into 0 series holders. See page A30: 7 for visual.

A30: 112 - 143

A30: 38 - 42

A30: 4 - 6

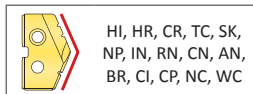
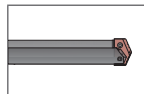
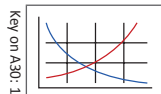

Coatings not listed above can be supplied as non-stocked standards. Process fees apply. →

TiN = 150T-XXXX	TiAlN = 150A-XXXX
TiCN = 150N-XXXX	AM200® = 150H-XXXX



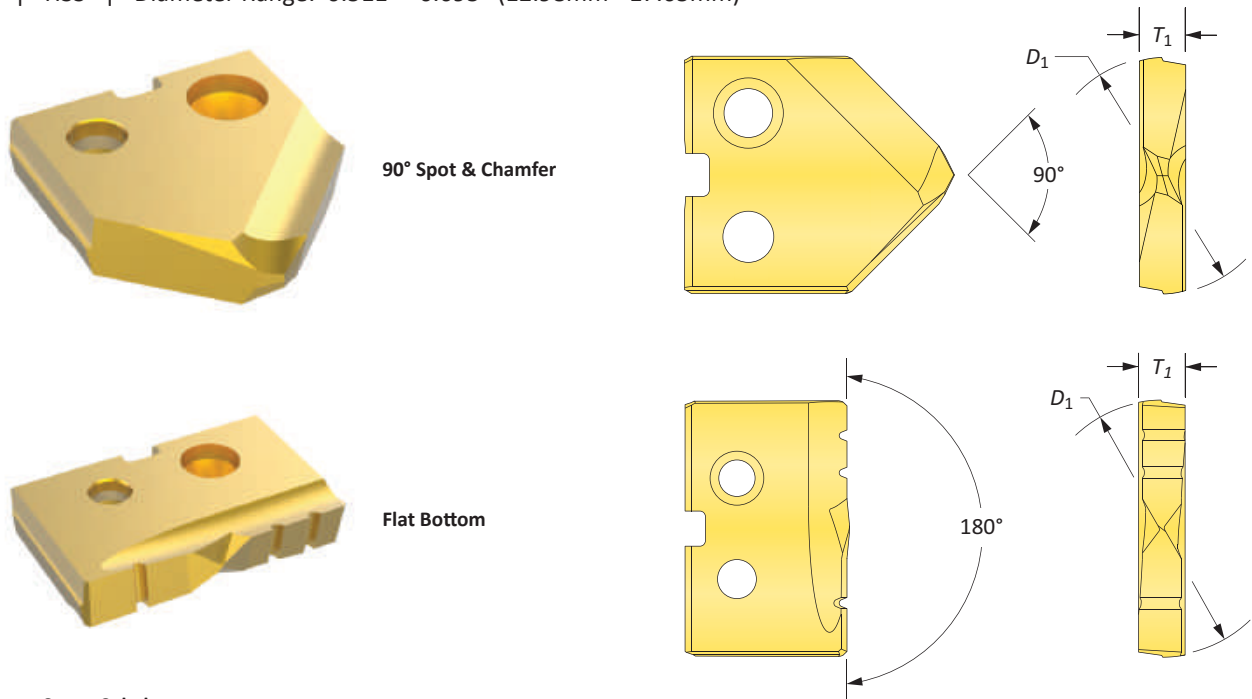

Inserts sold in quantities of 2

### Original T-A Drill Inserts

0 Series | HSS | Diameter Range: 0.511" - 0.695" (12.98mm - 17.65mm)



#### HSS Inserts – Super Cobalt

Series	Insert				90° Spot & Chamfer Part No.			Flat Bottom Part No.
	Fractional Equivalent	D <sub>1</sub> inch	D <sub>1</sub> mm	T <sub>1</sub>	 TIN	 TiAlN	 TiCN	 TIN
0	-	0.5118	13.00	1/8	150T-13-SP	150A-13-SP	150N-13-SP	150T-13-FB
	33/64	0.5156	13.10	1/8	150T-515-SP	150A-515-SP	150N-515-SP	150T-515-FB
	17/32	0.5313	13.49	1/8	150T-0017-SP	150A-0017-SP	150N-0017-SP	150T-0017-FB
	-	0.5315	13.50	1/8	150T-13.5-SP	150A-13.5-SP	150N-13.5-SP	150T-13.5-FB
	35/64	0.5469	13.89	1/8	150T-546-SP	150A-546-SP	150N-546-SP	150T-546-FB
	-	0.5512	14.00	1/8	150T-14-SP	150A-14-SP	150N-14-SP	150T-14-FB
	9/16	0.5625	14.29	1/8	150T-0018-SP	150A-0018-SP	150N-0018-SP	150T-0018-FB
	-	0.5709	14.50	1/8	150T-14.5-SP	150A-14.5-SP	150N-14.5-SP	150T-14.5-FB
	37/64	0.5781	14.68	1/8	150T-578-SP	150A-578-SP	150N-578-SP	150T-578-FB
	-	0.5906	15.00	1/8	150T-15-SP	150A-15-SP	150N-15-SP	150T-15-FB
19/32	0.5938	15.08	1/8	150T-0019-SP	150A-0019-SP	150N-0019-SP	150T-0019-FB	
0.5	39/64	0.6094	15.48	1/8	150T-609-SP	150A-609-SP	150N-609-SP	150T-609-FB
	-	0.6102	15.50	1/8	150T-15.5-SP	150A-15.5-SP	150N-15.5-SP	150T-15.5-FB
	5/8	0.6250	15.88	1/8	150T-0020-SP	150A-0020-SP	150N-0020-SP	150T-0020-FB
	-	0.6299	16.00	1/8	150T-16-SP	150A-16-SP	150N-16-SP	150T-16-FB
	41/64	0.6406	16.27	1/8	150T-640-SP	150A-640-SP	150N-640-SP	150T-640-FB
	-	0.6496	16.50	1/8	150T-16.5-SP	150A-16.5-SP	150N-16.5-SP	150T-16.5-FB
	21/32	0.6563	16.67	1/8	150T-0021-SP	150A-0021-SP	150N-0021-SP	150T-0021-FB
	-	0.6693	17.00	1/8	150T-17-SP	150A-17-SP	150N-17-SP	150T-17-FB
	43/64	0.6719	17.07	1/8	150T-671-SP	150A-671-SP	150N-671-SP	150T-671-FB
	11/16	0.6875	17.46	1/8	150T-0022-SP	150A-0022-SP	150N-0022-SP	150T-0022-FB
-	0.6890	17.50	1/8	150T-17.5-SP	150A-17.5-SP	150N-17.5-SP	150T-17.5-FB	

**NOTE:** 0.5 series inserts fit into both 0 and 0.5 series holders. However, 0 series inserts ONLY fit into 0 series holders. See page A30: 7 for visual.

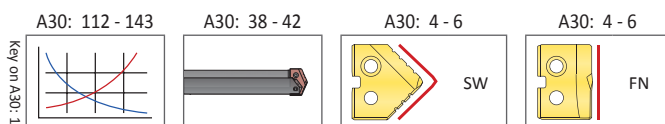

Coatings not listed above can be supplied as non-stocked standards. Process fees apply. →

TiN = 150T-XXXX	TiAlN = 150A-XXXX
TiCN = 150N-XXXX	AM200® = 150H-XXXX

Inserts sold in quantities of 2

## Original T-A Drill Inserts

0 Series | Carbide | Diameter Range: 0.511" - 0.695" (12.98mm - 17.65mm)



Standard

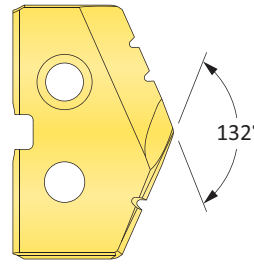

132°

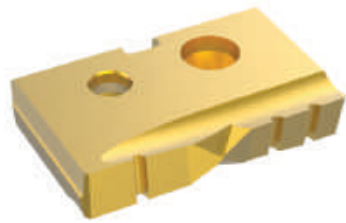
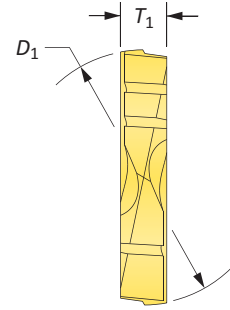

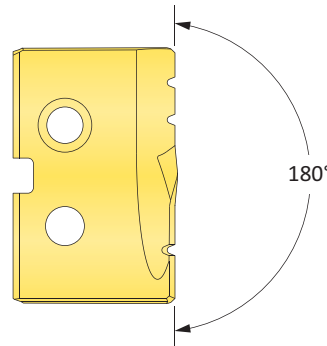

Flat Bottom

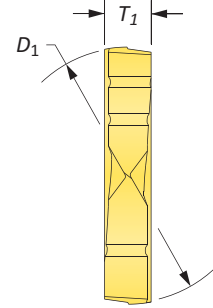

180°



### Carbide Inserts – C2 (K20)

Series	Fractional Equivalent	Insert			Part No.		Flat Bottom Part No.
		D <sub>1</sub> inch	D <sub>1</sub> mm	T <sub>1</sub>	 TiN	 TiAlN	 TiN
0	-	0.5118	13.00	1/8	<b>1C20T-13</b>	<b>1C20A-13</b>	<b>1C20T-13-FB</b>
	33/64	0.5156	13.10	1/8	<b>1C20T-.515</b>	<b>1C20A-.515</b>	<b>1C20T-.515-FB</b>
	17/32	0.5313	13.49	1/8	<b>1C20T-0017</b>	<b>1C20A-0017</b>	<b>1C20T-0017-FB</b>
	-	0.5315	13.50	1/8	<b>1C20T-13.5</b>	<b>1C20A-13.5</b>	<b>1C20T-13.5-FB</b>
	35/64	0.5469	13.89	1/8	<b>1C20T-.546</b>	<b>1C20A-.546</b>	<b>1C20T-.546-FB</b>
	-	0.5512	14.00	1/8	<b>1C20T-14</b>	<b>1C20A-14</b>	<b>1C20T-14-FB</b>
	9/16	0.5625	14.29	1/8	<b>1C20T-0018</b>	<b>1C20A-0018</b>	<b>1C20T-0018-FB</b>
	-	0.5709	14.50	1/8	<b>1C20T-14.5</b>	<b>1C20A-14.5</b>	<b>1C20T-14.5-FB</b>
	37/64	0.5781	14.68	1/8	<b>1C20T-.578</b>	<b>1C20A-.578</b>	<b>1C20T-.578-FB</b>
	-	0.5906	15.00	1/8	<b>1C20T-15</b>	<b>1C20A-15</b>	<b>1C20T-15-FB</b>
19/32	0.5938	15.08	1/8	<b>1C20T-0019</b>	<b>1C20A-0019</b>	<b>1C20T-0019-FB</b>	
0.5	39/64	0.6094	15.48	1/8	<b>1C20T-.609</b>	<b>1C20A-.609</b>	<b>1C20T-.609-FB</b>
	-	0.6102	15.50	1/8	<b>1C20T-15.5</b>	<b>1C20A-15.5</b>	<b>1C20T-15.5-FB</b>
	5/8	0.6250	15.88	1/8	<b>1C20T-0020</b>	<b>1C20A-0020</b>	<b>1C20T-0020-FB</b>
	-	0.6299	16.00	1/8	<b>1C20T-16</b>	<b>1C20A-16</b>	<b>1C20T-16-FB</b>
	41/64	0.6406	16.27	1/8	<b>1C20T-.640</b>	<b>1C20A-.640</b>	<b>1C20T-.640-FB</b>
	-	0.6496	16.50	1/8	<b>1C20T-16.5</b>	<b>1C20A-16.5</b>	<b>1C20T-16.5-FB</b>
	21/32	0.6563	16.67	1/8	<b>1C20T-0021</b>	<b>1C20A-0021</b>	<b>1C20T-0021-FB</b>
	-	0.6693	17.00	1/8	<b>1C20T-17</b>	<b>1C20A-17</b>	<b>1C20T-17-FB</b>
	43/64	0.6719	17.07	1/8	<b>1C20T-.671</b>	<b>1C20A-.671</b>	<b>1C20T-.671-FB</b>
	11/16	0.6875	17.46	1/8	<b>1C20T-0022</b>	<b>1C20A-0022</b>	<b>1C20T-0022-FB</b>
-	0.6890	17.50	1/8	<b>1C20T-17.5</b>	<b>1C20A-17.5</b>	<b>1C20T-17.5-FB</b>	

**NOTE:** 0.5 series inserts fit into both 0 and 0.5 series holders. However, 0 series inserts ONLY fit into 0 series holders. See page A30: 7 for visual.

Inserts sold in quantities of 1

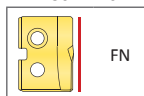
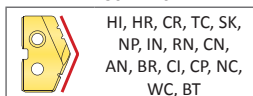
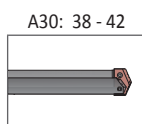
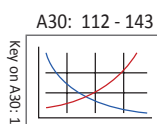

Coatings not listed above can be supplied as non-stocked standards. Process fees apply. →

TiN = 1C20T-XXXX	TiAlN = 1C20A-XXXX
TiCN = 1C20N-XXXX	AM200® = 1C20H-XXXX





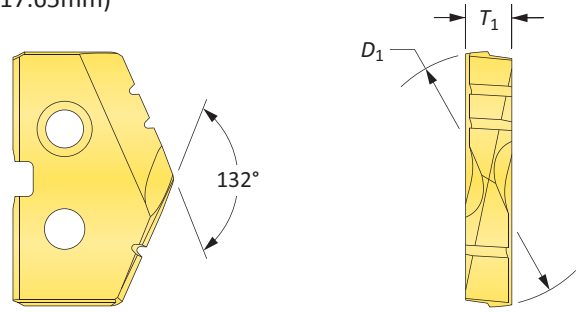

## Original T-A Drill Inserts

0 Series | Carbide | Diameter Range: 0.511" - 0.695" (12.98mm - 17.65mm)



Carbide Inserts – C5 (P40) | C3 (K10) | N2

Series	Insert				C5 Part No.		C3 Part No.	N2 Part No.
	Fractional Equivalent	D <sub>1</sub> inch	D <sub>1</sub> mm	T <sub>1</sub>	 TiN	 TiAlN	 TiAlN (Cast Iron)	 Diamond Film*
0	–	0.5118	13.00	1/8	<b>1C50T-13</b>	<b>1C50A-13</b>	<b>1C30A-13-CI</b>	<b>1N20D-13</b>
	33/64	0.5156	13.10	1/8	<b>1C50T-.515</b>	<b>1C50A-.515</b>	<b>1C30A-.515-CI</b>	<b>1N20D-.515</b>
	17/32	0.5313	13.49	1/8	<b>1C50T-0017</b>	<b>1C50A-0017</b>	<b>1C30A-0017-CI</b>	<b>1N20D-0017</b>
	–	0.5315	13.50	1/8	<b>1C50T-13.5</b>	<b>1C50A-13.5</b>	<b>1C30A-13.5-CI</b>	<b>1N20D-13.5</b>
	35/64	0.5469	13.89	1/8	<b>1C50T-.546</b>	<b>1C50A-.546</b>	<b>1C30A-.546-CI</b>	<b>1N20D-.546</b>
	–	0.5512	14.00	1/8	<b>1C50T-14</b>	<b>1C50A-14</b>	<b>1C30A-14-CI</b>	<b>1N20D-14</b>
	9/16	0.5625	14.29	1/8	<b>1C50T-0018</b>	<b>1C50A-0018</b>	<b>1C30A-0018-CI</b>	<b>1N20D-0018</b>
	–	0.5709	14.50	1/8	<b>1C50T-14.5</b>	<b>1C50A-14.5</b>	<b>1C30A-14.5-CI</b>	<b>1N20D-14.5</b>
	37/64	0.5781	14.68	1/8	<b>1C50T-.578</b>	<b>1C50A-.578</b>	<b>1C30A-.578-CI</b>	<b>1N20D-.578</b>
	–	0.5906	15.00	1/8	<b>1C50T-15</b>	<b>1C50A-15</b>	<b>1C30A-15-CI</b>	<b>1N20D-15</b>
0.5	19/32	0.5938	15.08	1/8	<b>1C50T-0019</b>	<b>1C50A-0019</b>	<b>1C30A-0019-CI</b>	<b>1N20D-0019</b>
	39/64	0.6094	15.48	1/8	<b>1C50T-.609</b>	<b>1C50A-.609</b>	<b>1C30A-.609-CI</b>	<b>1N20D-.609</b>
	–	0.6102	15.50	1/8	<b>1C50T-15.5</b>	<b>1C50A-15.5</b>	<b>1C30A-15.5-CI</b>	<b>1N20D-15.5</b>
	5/8	0.6250	15.88	1/8	<b>1C50T-0020</b>	<b>1C50A-0020</b>	<b>1C30A-0020-CI</b>	<b>1N20D-0020</b>
	–	0.6299	16.00	1/8	<b>1C50T-16</b>	<b>1C50A-16</b>	<b>1C30A-16-CI</b>	<b>1N20D-16</b>
	41/64	0.6406	16.27	1/8	<b>1C50T-.640</b>	<b>1C50A-.640</b>	<b>1C30A-.640-CI</b>	<b>1N20D-.640</b>
	–	0.6496	16.50	1/8	<b>1C50T-16.5</b>	<b>1C50A-16.5</b>	<b>1C30A-16.5-CI</b>	<b>1N20D-16.5</b>
	21/32	0.6563	16.67	1/8	<b>1C50T-0021</b>	<b>1C50A-0021</b>	<b>1C30A-0021-CI</b>	<b>1N20D-0021</b>
	–	0.6693	17.00	1/8	<b>1C50T-17</b>	<b>1C50A-17</b>	<b>1C30A-17-CI</b>	<b>1N20D-17</b>
	43/64	0.6719	17.07	1/8	<b>1C50T-.671</b>	<b>1C50A-.671</b>	<b>1C30A-.671-CI</b>	<b>1N20D-.671</b>
11/16	0.6875	17.46	1/8	<b>1C50T-0022</b>	<b>1C50A-0022</b>	<b>1C30A-0022-CI</b>	<b>1N20D-0022</b>	
–	0.6890	17.50	1/8	<b>1C50T-17.5</b>	<b>1C50A-17.5</b>	<b>1C30A-17.5-CI</b>	<b>1N20D-17.5</b>	

**NOTE:** 0.5 series inserts fit into both 0 and 0.5 series holders. However, 0 series inserts ONLY fit into 0 series holders. See page A30: 7 for visual.

\*Diamond Film is only available in standard geometry. For additional geometries, please contact Application Engineering.

A30: 112 - 143

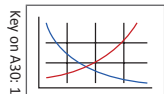

A30: 38 - 42

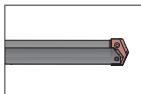

A30: 4 - 6

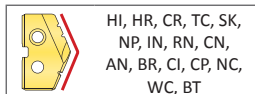

Coatings not listed above can be supplied as non-stocked standards. Process fees apply. →

Inserts sold in quantities of 1

TiN = 1C50T-XXXX	TiAlN = 1C50A-XXXX
TiCN = 1C50N-XXXX	AM200® = 1C50H-XXXX

## T-A Drill Insert Holders

0 Series | Flange Shank | Diameter Range: 0.511" - 0.695" (12.98mm - 17.65mm)

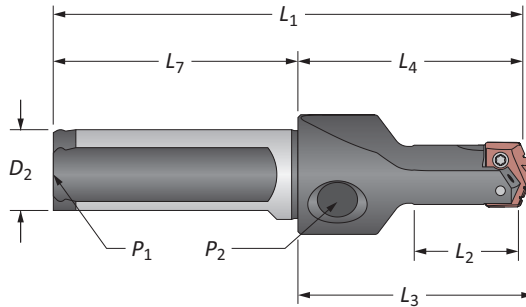
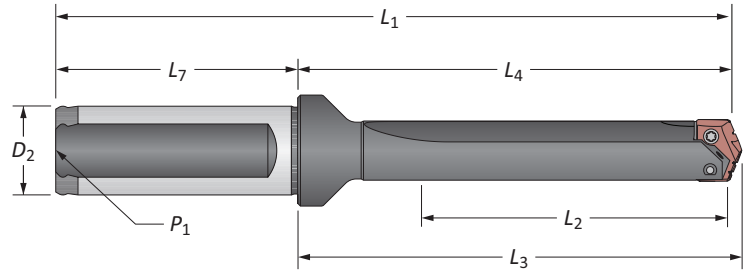

Stub Length

### Straight Flute

Series	Length	Body				Shank			Part No.
		L <sub>2</sub>	L <sub>4</sub>	L <sub>3</sub>	L <sub>1</sub>	D <sub>2</sub>	L <sub>7</sub>	P <sub>1</sub>	
0	Stub	7/8	1-7/8	1-63/64	3-29/32	3/4	2-1/32	1/8	21000S-075F
	Short	1-3/8	2-1/2	2-39/64	4-17/32	3/4	2-1/32	1/8	22000S-075F
	Standard	2-1/2	3-5/8	3-47/64	5-21/32	3/4	2-1/32	1/8	24000S-075F
	Extended	4-1/2	5-5/8	5-47/64	7-21/32	3/4	2-1/32	1/8	▲ 25000S-075F
0.5	Stub	7/8	1-7/8	1-63/64	3-29/32	3/4	2-1/32	1/8	21005S-075F
	Short	1-3/8	2-1/2	2-39/64	4-17/32	3/4	2-1/32	1/8	22005S-075F
	Standard	2-1/2	3-5/8	3-47/64	5-21/32	3/4	2-1/32	1/8	24005S-075F
	Extended	4-1/2	5-5/8	5-47/64	7-21/32	3/4	2-1/32	1/8	▲ 25005S-075F
0	Stub	22.2	47.6	50.4	97.6	20.0	50.0	1/8*	21000S-20FM
	Short	34.9	63.5	66.3	113.5	20.0	50.0	1/8*	22000S-20FM
	XL	295.0	323.9	326.7	373.9	20.0	50.0	1/8*	▲ 27000S-20FM
	3XL	387.0	416.0	418.8	466.0	20.0	50.0	1/8*	▲ 29000S-20FM
	0.5	Stub	22.2	47.6	50.4	97.6	20.0	50.0	1/8*
	Short	34.9	63.5	66.3	113.5	20.0	50.0	1/8*	22005S-20FM

\*Metric thread to BSP and ISO 7-1

**NOTE:** Stub length holders have a 1/8" side pipe tap (P<sub>2</sub>)

**NOTE:** 0.5 series inserts fit into both 0 and 0.5 series holders. However, 0 series inserts ONLY fit into 0 series holders. See page A30: 7 for visual.

### Connection Accessories

Series	Insert Screws	Nylon Locking Screws	Insert Driver	Preset Torque Hand Driver	Replacement Tips	Admissible Tightening Torque*
0	72556-IP8-1	72556N-IP8-1	8IP-8	8IP-8TL	8IP-8B	15.5 in-lbs (175 N-cm)
0.5	72567-IP8-1	72567N-IP8-1	8IP-8	8IP-8TL	8IP-8B	15.5 in-lbs (175 N-cm)

\*Tightening torques are calculated with a friction coefficient of  $\mu = 0.14$  and develop 90% of ultimate yield strength

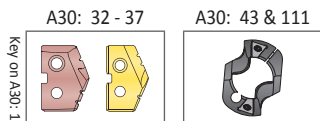

i = Imperial (in)  
m = Metric (mm)

Screws sold in quantities of 10

**WARNING** Refer to Speed and Feed charts for recommended adjustments to speeds and feeds. Refer to page A30: 146 for deep hole drilling guidelines in this section of the catalog. Visit [www.alliedmachine.com/DeepHoleGuidelines](http://www.alliedmachine.com/DeepHoleGuidelines) for the most up-to-date information and procedures. Factory technical assistance is available for your specific applications through our Application Engineering Team.



## T-A Drill Insert Holders

0 Series | Flange Shank | Diameter Range: 0.511" - 0.695" (12.98mm - 17.65mm)

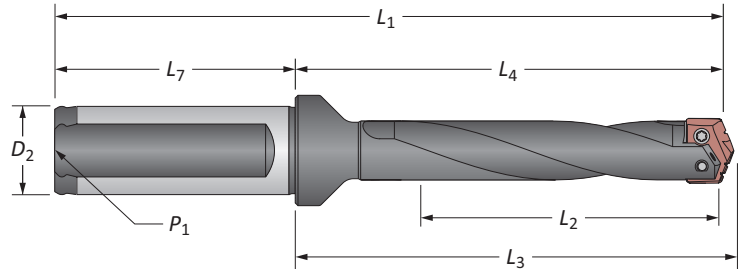

### Helical Flute

Series	Length	Body				Shank			Part No.	
		L <sub>2</sub>	L <sub>4</sub>	L <sub>3</sub>	L <sub>1</sub>	D <sub>2</sub>	L <sub>7</sub>	P <sub>1</sub>		
i	Standard	2-1/2	3-5/8	3-47/64	5-21/32	3/4	2-1/32	1/8	24000H-075F	
	Standard Plus	3-1/2	4-5/8	4-37/64	6-39/64	3/4	2-1/32	1/8	24500H-075F	
	Extended	4-1/2	5-5/8	5-47/64	7-21/32	3/4	2-1/32	1/8	⚠ 25000H-075F	
	Long	7	8-1/8	8-15/64	10-5/32	3/4	2-1/32	1/8	⚠ 26000H-075F	
	Long Plus	9-7/16	10-37/64	10-11/16	12-23/32	3/4	2-1/32	1/8	⚠ 26500H-075F	
0.5	Standard	2-1/2	3-5/8	3-47/64	5-21/32	3/4	2-1/32	1/8	24005H-075F	
	Extended	4-1/2	5-5/8	5-47/64	7-21/32	3/4	2-1/32	1/8	⚠ 25005H-075F	
	Long	7	8-1/8	8-15/64	10-5/32	3/4	2-1/32	1/8	⚠ 26005H-075F	
ii	Standard	63.5	92.1	94.9	142.1	20.0	50.0	1/8*	24000H-20FM	
	Standard Plus	89.0	117.6	120.4	167.6	20.0	50.0	1/8*	24500H-20FM	
	Extended	114.3	142.9	145.7	192.9	20.0	50.0	1/8*	⚠ 25000H-20FM	
	Long	177.8	206.4	209.1	256.4	20.0	50.0	1/8*	⚠ 26000H-20FM	
	Long Plus	240.0	268.6	271.4	318.6	20.0	50.0	1/8*	⚠ 26500H-20FM	
	0.5	Standard	63.5	92.1	94.9	142.1	20.0	50.0	1/8*	24005H-20FM
		Extended	114.3	142.9	145.7	192.9	20.0	50.0	1/8*	⚠ 25005H-20FM
Long		177.8	206.4	209.1	256.4	20.0	50.0	1/8*	⚠ 26005H-20FM	

\*Metric thread to BSP and ISO 7-1NTE: 0.5 hold)

**NOTE:** 0.5 series inserts fit into both 0 and 0.5 series holders. However, 0 series inserts ONLY fit into 0 series holders. See page A30: 7 for visual.

### Connection Accessories

Series	Insert Screws	Nylon Locking Screws	Insert Driver	Preset Torque Hand Driver	Replacement Tips	Admissible Tightening Torque*
0	72556-IP8-1	72556N-IP8-1	8IP-8	8IP-8TL	8IP-8B	15.5 in-lbs (175 N-cm)
0.5	72567-IP8-1	72567N-IP8-1	8IP-8	8IP-8TL	8IP-8B	15.5 in-lbs (175 N-cm)

\*Tightening torques are calculated with a friction coefficient of  $\mu = 0.14$  and develop 90% of ultimate yield strength

A30: 32 - 37

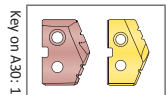

i = Imperial (in)  
ii = Metric (mm)

Screws sold in quantities of 10

**⚠ WARNING** Refer to Speed and Feed charts for recommended adjustments to speeds and feeds. Refer to page A30: 146 for deep hole drilling guidelines in this section of the catalog. Visit [www.alliedmachine.com/DeepHoleGuidelines](http://www.alliedmachine.com/DeepHoleGuidelines) for the most up-to-date information and procedures. Factory technical assistance is available for your specific applications through our Application Engineering Team.

## T-A Drill Insert Holders

0 Series | Taper Shank | Diameter Range: 0.511" - 0.695" (12.98mm - 17.65mm)

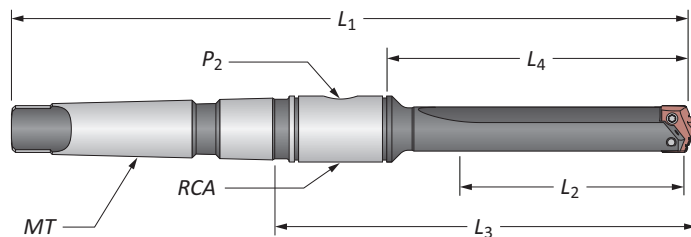

### Straight Flute

Series	Length	Body				Shank			Part No.
		L <sub>2</sub>	L <sub>4</sub>	L <sub>3</sub>	L <sub>1</sub>	MT	P <sub>2</sub>	RCA	
i 0	Short	1-3/8	2-3/16	3-41/64	6-15/32	#2	1/16	2T-2SR	22000S-002I
	Standard	2-1/2	3-5/16	4-49/64	7-19/32	#2	1/16	2T-2SR	24000S-002I
	Extended	4-1/2	5-5/16	6-49/64	9-19/32	#2	1/16	2T-2SR	25000S-002I
i 0.5	Short	1-3/8	2-3/16	3-41/64	6-15/32	#2	1/16	2T-2SR	22005S-002I
	Standard	2-1/2	3-5/16	4-49/64	7-19/32	#2	1/16	2T-2SR	24005S-002I
	Extended	4-1/2	5-5/16	6-49/64	9-19/32	#2	1/16	2T-2SR	25005S-002I
m 0	Short	35.0	55.5	92.4	164.3	#2**	1/16*	2T-2SRM	22000S-002M
	0.5	Short	35.0	55.5	92.4	164.3	#2**	1/16*	22005S-002M

\*Metric thread to BSP and ISO 7-1

\*\*Per ISO 296 type BEK

**NOTE:** 0.5 series inserts fit into both 0 and 0.5 series holders. However, 0 series inserts ONLY fit into 0 series holders. See page A30: 7 for visual.

### Connection Accessories

Series	Insert Screws	Nylon Locking Screws	Insert Driver	Preset Torque Hand Driver	Replacement Tips	Admissible Tightening Torque*
0	72556-IP8-1	72556N-IP8-1	8IP-8	8IP-8TL	8IP-8B	15.5 in-lbs (175 N-cm)
0.5	72567-IP8-1	72567N-IP8-1	8IP-8	8IP-8TL	8IP-8B	15.5 in-lbs (175 N-cm)

\*Tightening torques are calculated with a friction coefficient of  $\mu = 0.14$  and develop 90% of ultimate yield strength

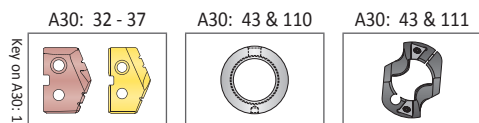

i = Imperial (in)

m = Metric (mm)

Screws sold in quantities of 10

**WARNING** Refer to Speed and Feed charts for recommended adjustments to speeds and feeds. Refer to page A30: 146 for deep hole drilling guidelines in this section of the catalog. Visit [www.alliedmachine.com/DeepHoleGuidelines](http://www.alliedmachine.com/DeepHoleGuidelines) for the most up-to-date information and procedures. Factory technical assistance is available for your specific applications through our Application Engineering Team.



## T-A Drill Insert Holders

0 Series | Taper Shank | Diameter Range: 0.511" - 0.695" (12.98mm - 17.65mm)

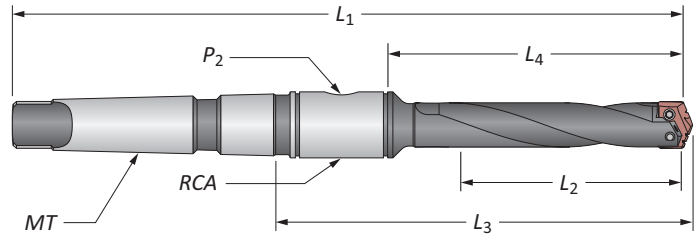

### Helical Flute

Series	Length	Body				Shank			Part No.	
		L <sub>2</sub>	L <sub>4</sub>	L <sub>3</sub>	L <sub>1</sub>	MT	P <sub>2</sub>	RCA		
i	0	Standard	2-1/2	3-5/16	4-49/64	7-19/32	#2	1/16	2T-2SR	24000H-002I
	0.5	Extended	4-1/2	5-5/16	6-49/64	9-19/32	#2	1/16	2T-2SR	25000H-002I
		Long	7	7-13/16	8-17/64	12-3/32	#2	1/16	2T-2SR	26000H-002I
m	0	Standard	63.5	84.1	121.0	192.9	#2**	1/16*	2T-2SRM	24000H-002M
		Extended	114.3	135.0	171.8	243.7	#2**	1/16*	2T-2SRM	25000H-002M
		Long	177.8	198.5	235.3	307.2	#2**	1/16*	2T-2SRM	26000H-002M
	0.5	Standard	63.5	84.1	121.0	192.9	#2**	1/16*	2T-2SRM	24005H-002M
		Extended	114.3	135.0	171.8	243.7	#2**	1/16*	2T-2SRM	25005H-002M
		Long	177.8	198.5	235.3	307.2	#2**	1/16*	2T-2SRM	26005H-002M

\*Metric thread to BSP and ISO 7-1

\*\*Per ISO 296 type BEK

**NOTE:** 0.5 series inserts fit into both 0 and 0.5 series holders. However, 0 series inserts ONLY fit into 0 series holders. See page A30: 7 for visual.

### Connection Accessories

Series	Insert Screws	Nylon Locking Screws	Insert Driver	Preset Torque Hand Driver	Replacement Tips	Admissible Tightening Torque*
0	72556-IP8-1	72556N-IP8-1	8IP-8	8IP-8TL	8IP-8B	15.5 in-lbs (175 N-cm)
0.5	72567-IP8-1	72567N-IP8-1	8IP-8	8IP-8TL	8IP-8B	15.5 in-lbs (175 N-cm)

\*Tightening torques are calculated with a friction coefficient of  $\mu = 0.14$  and develop 90% of ultimate yield strength

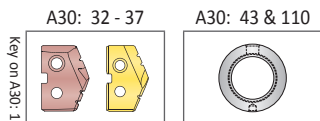

i = Imperial (in)  
m = Metric (mm)

Screws sold in quantities of 10

**WARNING** Refer to Speed and Feed charts for recommended adjustments to speeds and feeds. Refer to page A30: 146 for deep hole drilling guidelines in this section of the catalog. Visit [www.alliedmachine.com/DeepHoleGuidelines](http://www.alliedmachine.com/DeepHoleGuidelines) for the most up-to-date information and procedures. Factory technical assistance is available for your specific applications through our Application Engineering Team.

## T-A Drill Insert Holders

0 Series | Straight Shank | ER Collet | Diameter Range: 0.511" - 0.695" (12.98mm - 17.65mm)

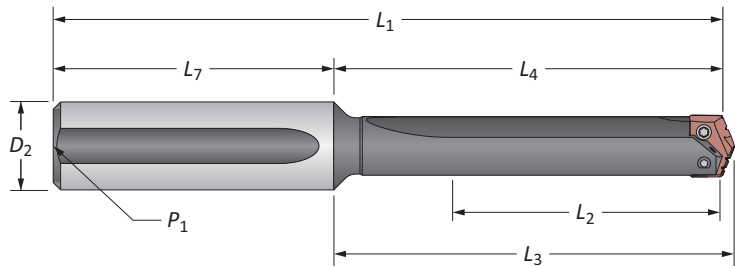

### Straight Flute

Series	Length	Body				Shank			Part No.
		L <sub>2</sub>	L <sub>4</sub>	L <sub>3</sub>	L <sub>1</sub>	D <sub>2</sub>	L <sub>7</sub>	P <sub>1</sub>	
0	Short	1-3/8	2-3/16	2-19/64	4-9/16	3/4	2-3/8	1/8	22000S-075L
	Standard	2-1/2	3-5/16	3-27/64	5-11/16	3/4	2-3/8	1/8	24000S-075L
	Extended	4-1/2	5-5/16	5-27/64	7-11/16	3/4	2-3/8	1/8	25000S-075L
	Long	7	7-13/16	7-59/64	10-3/16	3/4	2-3/8	1/8	26000S-075L
	XL	11-5/8	12-7/16	12-35/64	14-13/16	3/4	2-3/8	1/8	27000S-075L
0.5	3XL	15-1/4	16-1/16	16-11/64	18-7/16	3/4	2-3/8	1/8	29000S-075L
	Short	1-3/8	2-3/16	2-19/64	4-9/16	3/4	2-3/8	1/8*	22005S-075L
	Standard	2-1/2	3-5/16	3-27/64	5-11/16	3/4	2-3/8	1/8*	24005S-075L
	Extended	4-1/2	5-5/16	5-27/64	7-11/16	3/4	2-3/8	1/8*	25005S-075L
	Long	7	7-13/16	7-59/64	10-3/16	3/4	2-3/8	1/8*	26005S-075L

**NOTE:** 0.5 series inserts fit into both 0 and 0.5 series holders. However, 0 series inserts ONLY fit into 0 series holders. See page A30: 7 for visual.

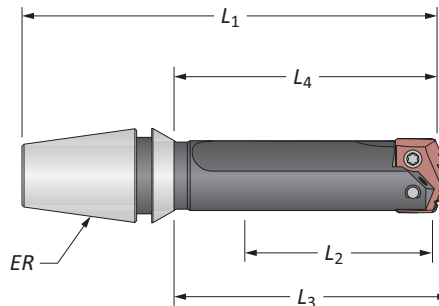

### ER Collet Holder

Series	Body				ER	Part No.	Collet Nut without Retaining Ring
	L <sub>2</sub>	L <sub>4</sub>	L <sub>3</sub>	L <sub>1</sub>			
0	1-3/8	1-57/64	2	3-5/64	ER-16	21000S-16ER	ER-16N
	1-3/8	1-57/64	2	3-15/64	ER-20	21000S-20ER	ER-20N

### Connection Accessories

Series	Insert Screws	Nylon Locking Screws	Insert Driver	Preset Torque Hand Driver	Replacement Tips	Admissible Tightening Torque*
0	72556-IP8-1	72556N-IP8-1	8IP-8	8IP-8TL	8IP-8B	15.5 in-lbs (175 N-cm)
0.5	72567-IP8-1	72567N-IP8-1	8IP-8	8IP-8TL	8IP-8B	15.5 in-lbs (175 N-cm)

\*Tightening torques are calculated with a friction coefficient of  $\mu = 0.14$  and develop 90% of ultimate yield strength

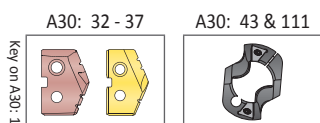

i = Imperial (in)  
m = Metric (mm)

Screws sold in quantities of 10

**WARNING** Refer to Speed and Feed charts for recommended adjustments to speeds and feeds. Refer to page A30: 146 for deep hole drilling guidelines in this section of the catalog. Visit [www.alliedmachine.com/DeepHoleGuidelines](http://www.alliedmachine.com/DeepHoleGuidelines) for the most up-to-date information and procedures. Factory technical assistance is available for your specific applications through our Application Engineering Team.



T-A Drill Accessories

O Series | Chamfer Rings | Rotary Coolant Adapters | Torx® Plus Screws

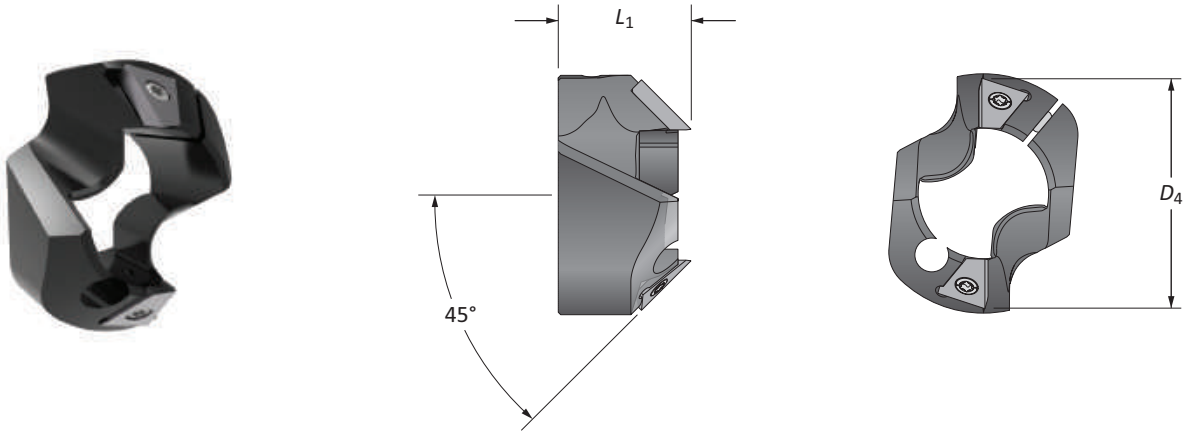

T-ACR 45 Chamfer Ring

Holder Series	D <sub>1</sub> Range	Chamfer Ring		Part No.	Insert Part No.	Insert Screw	Insert Driver	Clamping Screw	Insert Driver
		D <sub>4</sub>	L <sub>1</sub>						
0	0.5118 - 0.6890	13/16	0.676	T-ACR-45-0	T-ACRI-45-B-C5A	7255-IP8-1	8IP-8	7375-IP9-1	8IP-9

Rotary Coolant Adapter (RCA) and Accessories

ID	OD	L <sub>1</sub>	Driving Rod Thread	P <sub>1</sub>	Part No.	RCA O-Rings	
						Kit Part No.**	Replacements
<i>i</i> 3/4	1-3/4	7/8	5/16-18	1/8	<i>i</i> 2T-2SR	2T1-2SR	2T1-2OR-10
<i>m</i> 19.05	44.45	22.23	M8 x 1.25	1/8*	<i>m</i> 2T-2SRM	2T1-2SR	2T1-2OR-10

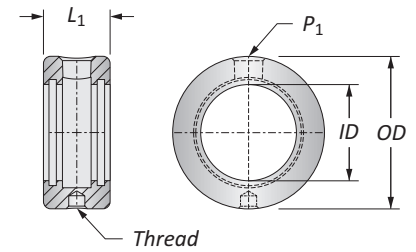

\*Thread to BSP and ISO 7-1

\*\*RCA Repair Kit includes (2) O-rings, (2) snap rings, and (2) thrust washers

*i* Refer to page A30: 110 for proper RCA assembly and safety information

Connection Accessories

Series	Insert Screws	Nylon Locking Screws	Insert Driver	Preset Torque Hand Driver	Replacement Tips	Admissible Tightening Torque*
0	72556-IP8-1	72556N-IP8-1	8IP-8	8IP-8TL	8IP-8B	15.5 in-lbs (175 N-cm)
0.5	72567-IP8-1	72567N-IP8-1	8IP-8	8IP-8TL	8IP-8B	15.5 in-lbs (175 N-cm)

\*Tightening torques are calculated with a friction coefficient of  $\mu = 0.14$  and develop 90% of ultimate yield strength

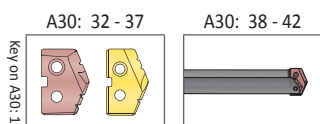

*i* = Imperial (in)  
*m* = Metric (mm)  
 Chamfer Ring Inserts sold separately  
 Screws sold in packs of 10  
 O-rings sold in packs of 10



***i* WARNING** RCA rotation during drilling can cause hose and/or hose fitting failure, machinery damage, and/or serious injury. To prevent, use RCA and positive stop studs when drilling. Factory technical assistance is also available for your specific applications.

## GEN2 T-A Drill Inserts

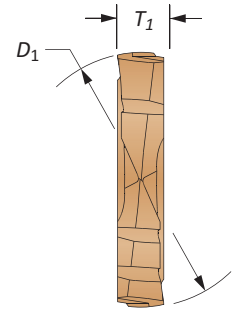
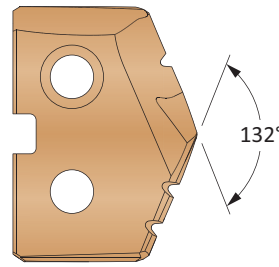
1 Series | Diameter Range: 0.690" - 0.960" (17.53mm - 24.38mm)



HSS Inserts – Super Cobalt • Carbide Inserts – C2 (K20) | C1 (K35)

Series	Fractional Equivalent	Insert			HSS Part No.	Carbide Part No.	
		$D_1$ inch	$D_1$ mm	$T_1$	 AM200® Super Cobalt	 AM300® C2 (K20)	 AM300® C1 (K35)
1	45/64	0.7031	17.86	5/32	451H-.703	4C21P-.703	4C11P-.703
	-	0.7087	18.00	5/32	451H-18	4C21P-18	4C11P-18
	23/32	0.7188	18.26	5/32	451H-0023	4C21P-0023	4C11P-0023
	-	0.7283	18.50	5/32	451H-18.5	4C21P-18.5	4C11P-18.5
	47/64	0.7344	18.65	5/32	451H-.734	4C21P-.734	4C11P-.734
	-	0.7480	19.00	5/32	451H-19	4C21P-19	4C11P-19
	3/4	0.7500	19.05	5/32	451H-0024	4C21P-0024	4C11P-0024
	49/64	0.7656	19.45	5/32	451H-.765	4C21P-.765	4C11P-.765
	-	0.7677	19.50	5/32	451H-19.5	4C21P-19.5	4C11P-19.5
	25/32	0.7813	19.84	5/32	451H-0025	4C21P-0025	4C11P-0025
	-	0.7874	20.00	5/32	451H-20	4C21P-20	4C11P-20
	51/64	0.7969	20.24	5/32	451H-.796	4C21P-.796	4C11P-.796
	-	0.8010	20.34	5/32	451H-.801	4C21P-.801	4C11P-.801
	-	0.8071	20.50	5/32	451H-20.5	4C21P-20.5	4C11P-20.5
	13/16	0.8125	20.64	5/32	451H-0026	4C21P-0026	4C11P-0026
	-	0.8268	21.00	5/32	451H-21	4C21P-21	4C11P-21
27/32	0.8438	21.43	5/32	451H-0027	4C21P-0027	4C11P-0027	
-	0.8465	21.50	5/32	451H-21.5	4C21P-21.5	4C11P-21.5	
1.5	55/64	0.8594	21.83	5/32	451H-.859	4C21P-.859	4C11P-.859
	-	0.8661	22.00	5/32	451H-22	4C21P-22	4C11P-22
	7/8	0.8750	22.23	5/32	451H-0028	4C21P-0028	4C11P-0028
	-	0.8858	22.50	5/32	451H-22.5	4C21P-22.5	4C11P-22.5
	57/64	0.8906	22.62	5/32	451H-.890	4C21P-.890	4C11P-.890
	-	0.9055	23.00	5/32	451H-23	4C21P-23	4C11P-23
	29/32	0.9063	23.02	5/32	451H-0029	4C21P-0029	4C11P-0029
	59/64	0.9219	23.42	5/32	451H-.921	4C21P-.921	4C11P-.921
	-	0.9252	23.50	5/32	451H-23.5	4C21P-23.5	4C11P-23.5
	15/16	0.9375	23.81	5/32	451H-0030	4C21P-0030	4C11P-0030
-	0.9449	24.00	5/32	451H-24	4C21P-24	4C11P-24	

A30: 112 - 143

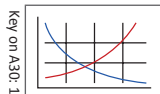

A30: 52 - 56

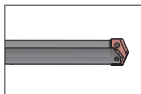

A30: 4 - 6



Inserts sold in quantities of 2

Coatings not listed above can be supplied as non-stocked standards. Process fees apply. →

TiN = 451T-XXXX

TiAlN = 451A-XXXX

TiCN = 451N-XXXX

AM200® = 451H-XXXX



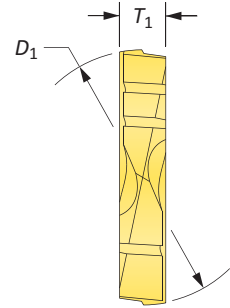
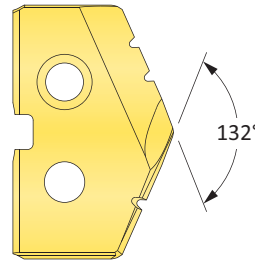

## Original T-A Drill Inserts

1 Series | HSS | Diameter Range: 0.690" - 0.960" (17.53mm - 24.38mm)



### HSS Inserts – Premium Cobalt

Series	Fractional Equivalent	Insert			Part No.		
		$D_1$ inch	$D_1$ mm	$T_1$	 TiN	 TiAlN	 TiCN
1	45/64	0.7031	17.86	5/32	<b>181T-.703</b>	<b>181A-.703</b>	<b>181N-.703</b>
	–	0.7087	18.00	5/32	<b>181T-18</b>	<b>181A-18</b>	<b>181N-18</b>
	23/32	0.7188	18.26	5/32	<b>181T-0023</b>	<b>181A-0023</b>	<b>181N-0023</b>
	–	0.7283	18.50	5/32	<b>181T-18.5</b>	<b>181A-18.5</b>	<b>181N-18.5</b>
	47/64	0.7344	18.65	5/32	<b>181T-.734</b>	<b>181A-.734</b>	<b>181N-.734</b>
	–	0.7480	19.00	5/32	<b>181T-19</b>	<b>181A-19</b>	<b>181N-19</b>
	3/4	0.7500	19.05	5/32	<b>181T-0024</b>	<b>181A-0024</b>	<b>181N-0024</b>
	49/64	0.7656	19.45	5/32	<b>181T-.765</b>	<b>181A-.765</b>	<b>181N-.765</b>
	–	0.7677	19.50	5/32	<b>181T-19.5</b>	<b>181A-19.5</b>	<b>181N-19.5</b>
	25/32	0.7813	19.84	5/32	<b>181T-0025</b>	<b>181A-0025</b>	<b>181N-0025</b>
	–	0.7874	20.00	5/32	<b>181T-20</b>	<b>181A-20</b>	<b>181N-20</b>
	51/64	0.7969	20.24	5/32	<b>181T-.796</b>	<b>181A-.796</b>	<b>181N-.796</b>
	–	0.8010	20.34	5/32	<b>181T-.801</b>	<b>181A-.801</b>	<b>181N-.801</b>
	–	0.8071	20.50	5/32	<b>181T-20.5</b>	<b>181A-20.5</b>	<b>181N-20.5</b>
	13/16	0.8125	20.64	5/32	<b>181T-0026</b>	<b>181A-0026</b>	<b>181N-0026</b>
–	0.8268	21.00	5/32	<b>181T-21</b>	<b>181A-21</b>	<b>181N-21</b>	
27/32	0.8438	21.43	5/32	<b>181T-0027</b>	<b>181A-0027</b>	<b>181N-0027</b>	
–	0.8465	21.50	5/32	<b>181T-21.5</b>	<b>181A-21.5</b>	<b>181N-21.5</b>	
1.5	55/64	0.8594	21.83	5/32	<b>181T-.859</b>	<b>181A-.859</b>	<b>181N-.859</b>
	–	0.8661	22.00	5/32	<b>181T-22</b>	<b>181A-22</b>	<b>181N-22</b>
	7/8	0.8750	22.23	5/32	<b>181T-0028</b>	<b>181A-0028</b>	<b>181N-0028</b>
	–	0.8858	22.50	5/32	<b>181T-22.5</b>	<b>181A-22.5</b>	<b>181N-22.5</b>
	57/64	0.8906	22.62	5/32	<b>181T-.890</b>	<b>181A-.890</b>	<b>181N-.890</b>
	–	0.9055	23.00	5/32	<b>181T-23</b>	<b>181A-23</b>	<b>181N-23</b>
	29/32	0.9063	23.02	5/32	<b>181T-0029</b>	<b>181A-0029</b>	<b>181N-0029</b>
	59/64	0.9219	23.42	5/32	<b>181T-.921</b>	<b>181A-.921</b>	<b>181N-.921</b>
	–	0.9252	23.50	5/32	<b>181T-23.5</b>	<b>181A-23.5</b>	<b>181N-23.5</b>
	15/16	0.9375	23.81	5/32	<b>181T-0030</b>	<b>181A-0030</b>	<b>181N-0030</b>
–	0.9449	24.00	5/32	<b>181T-24</b>	<b>181A-24</b>	<b>181N-24</b>	

**NOTE:** 1.5 series inserts fit into both 1 and 1.5 series holders. However, 1 series inserts ONLY fit into 1 series holders. See page A30: 7 for visual.

A30: 112 - 143

A30: 52 - 56

A30: 4 - 6

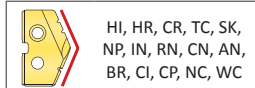
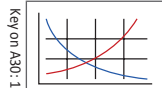

Coatings not listed above can be supplied as non-stocked standards. Process fees apply. →

Inserts sold in quantities of 2



<b>TiN = 181T-XXXX</b>	<b>TiAlN = 181A-XXXX</b>
<b>TiCN = 181N-XXXX</b>	<b>AM200® = 181H-XXXX</b>

## Original T-A Drill Inserts

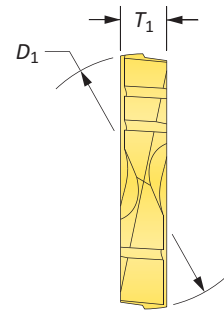
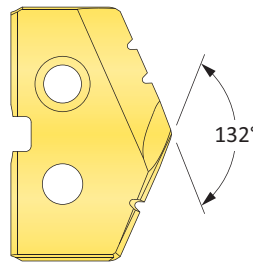
1 Series | HSS | Diameter Range: 0.690" - 0.960" (17.53mm - 24.38mm)



### HSS Inserts – Super Cobalt

Series	Insert				Part No.		
	Fractional Equivalent	$D_1$ inch	$D_1$ mm	$T_1$	 TiN	 TiAlN	 TiCN
1	45/64	0.7031	17.86	5/32	151T-.703	151A-.703	151N-.703
	-	0.7087	18.00	5/32	151T-18	151A-18	151N-18
	23/32	0.7188	18.26	5/32	151T-0023	151A-0023	151N-0023
	-	0.7283	18.50	5/32	151T-18.5	151A-18.5	151N-18.5
	47/64	0.7344	18.65	5/32	151T-.734	151A-.734	151N-.734
	-	0.7480	19.00	5/32	151T-19	151A-19	151N-19
	3/4	0.7500	19.05	5/32	151T-0024	151A-0024	151N-0024
	49/64	0.7656	19.45	5/32	151T-.765	151A-.765	151N-.765
	-	0.7677	19.50	5/32	151T-19.5	151A-19.5	151N-19.5
	25/32	0.7813	19.84	5/32	151T-0025	151A-0025	151N-0025
	-	0.7874	20.00	5/32	151T-20	151A-20	151N-20
	51/64	0.7969	20.24	5/32	151T-.796	151A-.796	151N-.796
	-	0.8010	20.34	5/32	151T-.801	151A-.801	151N-.801
	-	0.8071	20.50	5/32	151T-20.5	151A-20.5	151N-20.5
	13/16	0.8125	20.64	5/32	151T-0026	151A-0026	151N-0026
	-	0.8268	21.00	5/32	151T-21	151A-21	151N-21
27/32	0.8438	21.43	5/32	151T-0027	151A-0027	151N-0027	
-	0.8465	21.50	5/32	151T-21.5	151A-21.5	151N-21.5	
1.5	55/64	0.8594	21.83	5/32	151T-.859	151A-.859	151N-.859
	-	0.8661	22.00	5/32	151T-22	151A-22	151N-22
	7/8	0.8750	22.23	5/32	151T-0028	151A-0028	151N-0028
	-	0.8858	22.50	5/32	151T-22.5	151A-22.5	151N-22.5
	57/64	0.8906	22.62	5/32	151T-.890	151A-.890	151N-.890
	-	0.9055	23.00	5/32	151T-23	151A-23	151N-23
	29/32	0.9063	23.02	5/32	151T-0029	151A-0029	151N-0029
	59/64	0.9219	23.42	5/32	151T-.921	151A-.921	151N-.921
	-	0.9252	23.50	5/32	151T-23.5	151A-23.5	151N-23.5
15/16	0.9375	23.81	5/32	151T-0030	151A-0030	151N-0030	
-	0.9449	24.00	5/32	151T-24	151A-24	151N-24	

**NOTE:** 1.5 series inserts fit into both 1 and 1.5 series holders. However, 1 series inserts ONLY fit into 1 series holders. See page A30: 7 for visual.

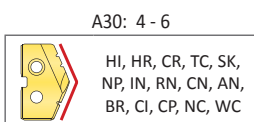
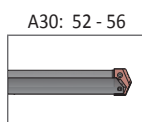
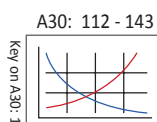

Coatings not listed above can be supplied as non-stocked standards. Process fees apply. →

TiN = 151T-XXXX	TiAlN = 151A-XXXX
TiCN = 151N-XXXX	AM200® = 151H-XXXX

Inserts sold in quantities of 2

Original T-A Drill Inserts

1 Series | HSS | Diameter Range: 0.690" - 0.960" (17.53mm - 24.38mm)



90° Spot & Chamfer

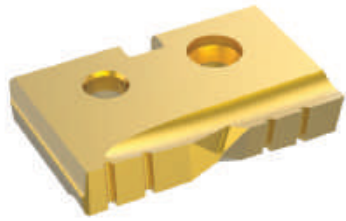
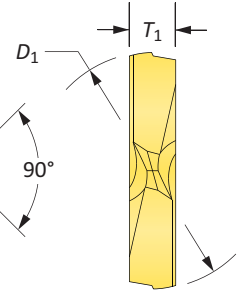
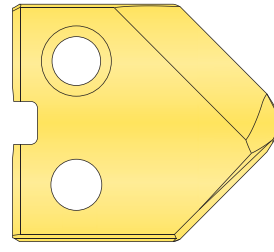

Flat Bottom

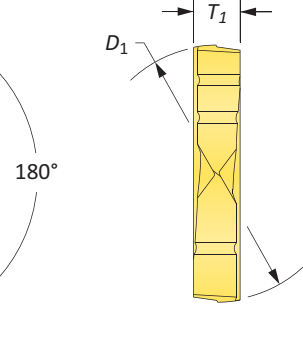
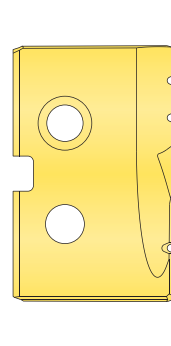

HSS Inserts – Super Cobalt

Series	Insert				90° Spot & Chamfer Part No.			Flat Bottom Part No.
	Fractional Equivalent	D <sub>1</sub> inch	D <sub>1</sub> mm	T <sub>1</sub>	TiN	TiAlN	TiCN	TiN
1	45/64	0.7031	17.86	5/32	151T-.703-SP	151A-.703-SP	151N-.703-SP	151T-.703-FB
	-	0.7087	18.00	5/32	151T-18-SP	151A-18-SP	151N-18-SP	151T-18-FB
	23/32	0.7188	18.26	5/32	151T-0023-SP	151A-0023-SP	151N-0023-SP	151T-0023-FB
	-	0.7283	18.50	5/32	151T-18.5-SP	151A-18.5-SP	151N-18.5-SP	151T-18.5-FB
	47/64	0.7344	18.65	5/32	151T-.734-SP	151A-.734-SP	151N-.734-SP	151T-.734-FB
	-	0.7480	19.00	5/32	151T-19-SP	151A-19-SP	151N-19-SP	151T-19-FB
	3/4	0.7500	19.05	5/32	151T-0024-SP	151A-0024-SP	151N-0024-SP	151T-0024-FB
	49/64	0.7656	19.45	5/32	151T-.765-SP	151A-.765-SP	151N-.765-SP	151T-.765-FB
	-	0.7677	19.50	5/32	151T-19.5-SP	151A-19.5-SP	151N-19.5-SP	151T-19.5-FB
	25/32	0.7813	19.84	5/32	151T-0025-SP	151A-0025-SP	151N-0025-SP	151T-0025-FB
	-	0.7874	20.00	5/32	151T-20-SP	151A-20-SP	151N-20-SP	151T-20-FB
	51/64	0.7969	20.24	5/32	151T-.796-SP	151A-.796-SP	151N-.796-SP	151T-.796-FB
	-	0.8010	20.34	5/32	151T-801-SP	151A-801-SP	151N-801-SP	151T-801-FB
	-	0.8071	20.50	5/32	151T-20.5-SP	151A-20.5-SP	151N-20.5-SP	151T-20.5-FB
	13/16	0.8125	20.64	5/32	151T-0026-SP	151A-0026-SP	151N-0026-SP	151T-0026-FB
	-	0.8268	21.00	5/32	151T-21-SP	151A-21-SP	151N-21-SP	151T-21-FB
	27/32	0.8438	21.43	5/32	151T-0027-SP	151A-0027-SP	151N-0027-SP	151T-0027-FB
-	0.8465	21.50	5/32	151T-21.5-SP	151A-21.5-SP	151N-21.5-SP	151T-21.5-FB	
1.5	55/64	0.8594	21.83	5/32	151T-.859-SP	151A-.859-SP	151N-.859-SP	151T-.859-FB
	-	0.8661	22.00	5/32	151T-22-SP	151A-22-SP	151N-22-SP	151T-22-FB
	7/8	0.8750	22.23	5/32	151T-0028-SP	151A-0028-SP	151N-0028-SP	151T-0028-FB
	-	0.8858	22.50	5/32	151T-22.5-SP	151A-22.5-SP	151N-22.5-SP	151T-22.5-FB
	57/64	0.8906	22.62	5/32	151T-.890-SP	151A-.890-SP	151N-.890-SP	151T-.890-FB
	-	0.9055	23.00	5/32	151T-23-SP	151A-23-SP	151N-23-SP	151T-23-FB
	29/32	0.9063	23.02	5/32	151T-0029-SP	151A-0029-SP	151N-0029-SP	151T-0029-FB
	59/64	0.9219	23.42	5/32	151T-.921-SP	151A-.921-SP	151N-.921-SP	151T-.921-FB
	-	0.9252	23.50	5/32	151T-23.5-SP	151A-23.5-SP	151N-23.5-SP	151T-23.5-FB
	15/16	0.9375	23.81	5/32	151T-0030-SP	151A-0030-SP	151N-0030-SP	151T-0030-FB
-	0.9449	24.00	5/32	151T-24-SP	151A-24-SP	151N-24-SP	151T-24-FB	

NOTE: 1.5 series inserts fit into both 1 and 1.5 series holders. However, 1 series inserts ONLY fit into 1 series holders. See page A30: 7 for visual.

A30: 112 - 143

A30: 52 - 56

A30: 4 - 6

SW

A30: 4 - 6

FN

Coatings not listed above can be supplied as non-stocked standards. Process fees apply. →

TiN = 151T-XXXX	TiAlN = 151A-XXXX
TiCN = 151N-XXXX	AM200® = 151H-XXXX

Inserts sold in quantities of 2

## Original T-A Drill Inserts



1 Series | HSS | Diameter Range: 0.690" - 0.960" (17.53mm - 24.38mm)

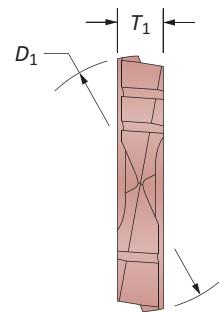
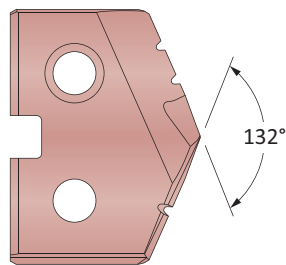

Tube Sheet



HSS Inserts – Super Cobalt | HSS

Series	Fractional Equivalent	Insert			Part No.	
		$D_1$ inch	$D_1$ mm	$T_1$	 Super Cobalt	 HSS
1	–	0.7580	19.25	5/32	<b>151H-.7580-IN</b>	<b>131H-.7580-IN</b>
	49/64	0.7656	19.45	5/32	<b>151H-.765-IN</b>	<b>131H-.765-IN</b>
	25/32	0.7813	19.85	5/32	<b>151H-0025-IN</b>	<b>131H-0025-IN</b>

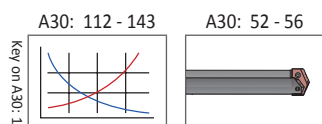

Coatings not listed above can be supplied as non-stocked standards. Process fees apply. →

TiN = 151T-XXXX	TiAlN = 151A-XXXX
TiCN = 151N-XXXX	AM200® = 151H-XXXX



Inserts sold in quantities of 2

### Original T-A Drill Inserts

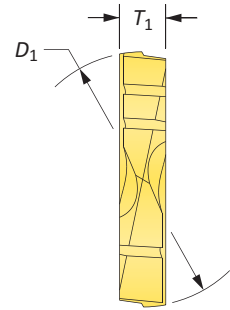
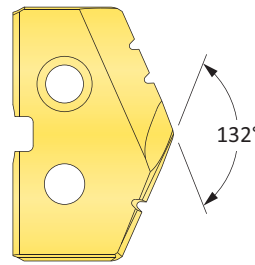
1 Series | HSS | Diameter Range: 0.690" - 0.960" (17.53mm - 24.38mm)





HSS Inserts – HSS

Series	Fractional Equivalent	Insert			Part No.		
		D <sub>1</sub> inch	D <sub>1</sub> mm	T <sub>1</sub>	 TiN	 TiAlN	 TiCN
1	45/64	0.7031	17.86	5/32	131T-.703	131A-.703	131N-.703
	-	0.7087	18.00	5/32	131T-18	131A-18	131N-18
	23/32	0.7188	18.26	5/32	131T-0023	131A-0023	131N-0023
	-	0.7283	18.50	5/32	131T-18.5	131A-18.5	131N-18.5
	47/64	0.7344	18.65	5/32	131T-.734	131A-.734	131N-.734
	-	0.7480	19.00	5/32	131T-19	131A-19	131N-19
	3/4	0.7500	19.05	5/32	131T-0024	131A-0024	131N-0024
	49/64	0.7656	19.45	5/32	131T-.765	131A-.765	131N-.765
	-	0.7677	19.50	5/32	131T-19.5	131A-19.5	131N-19.5
	25/32	0.7813	19.84	5/32	131T-0025	131A-0025	131N-0025
	-	0.7874	20.00	5/32	131T-20	131A-20	131N-20
	51/64	0.7969	20.24	5/32	131T-.796	131A-.796	131N-.796
	-	0.8010	20.34	5/32	131T-.801	131A-.801	131N-.801
	-	0.8071	20.50	5/32	131T-20.5	131A-20.5	131N-20.5
	13/16	0.8125	20.64	5/32	131T-0026	131A-0026	131N-0026
-	0.8268	21.00	5/32	131T-21	131A-21	131N-21	
27/32	0.8438	21.43	5/32	131T-0027	131A-0027	131N-0027	
-	0.8465	21.50	5/32	131T-21.5	131A-21.5	131N-21.5	
1.5	55/64	0.8594	21.83	5/32	131T-.859	131A-.859	131N-.859
	-	0.8661	22.00	5/32	131T-22	131A-22	131N-22
	7/8	0.8750	22.23	5/32	131T-0028	131A-0028	131N-0028
	-	0.8858	22.50	5/32	131T-22.5	131A-22.5	131N-22.5
	57/64	0.8906	22.62	5/32	131T-.890	131A-.890	131N-.890
	-	0.9055	23.00	5/32	131T-23	131A-23	131N-23
	29/32	0.9063	23.02	5/32	131T-0029	131A-0029	131N-0029
	59/64	0.9219	23.42	5/32	131T-.921	131A-.921	131N-.921
	-	0.9252	23.50	5/32	131T-23.5	131A-23.5	131N-23.5
	15/16	0.9375	23.81	5/32	131T-0030	131A-0030	131N-0030
-	0.9449	24.00	5/32	131T-24	131A-24	131N-24	

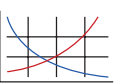
NOTE: 1.5 series inserts fit into both 1 and 1.5 series holders. However, 1 series inserts ONLY fit into 1 series holders. See page A30: 7 for visual.

A30: 112 - 143 

A30: 52 - 56 

A30: 4 - 6  HI, HR, CR, TC, SK, NP, IN, RN, CN, AN, BR, CI, CP, NC, WC

Coatings not listed above can be supplied as non-stocked standards. Process fees apply. →

TiN = 131T-XXXX	TiAlN = 131A-XXXX
TiCN = 131N-XXXX	AM200® = 131H-XXXX

Inserts sold in quantities of 2

## Original T-A Drill Inserts

1 Series | Carbide | Diameter Range: 0.690" - 0.960" (17.53mm - 24.38mm)



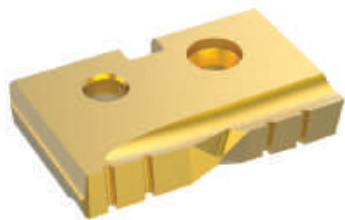
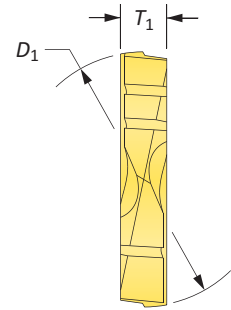
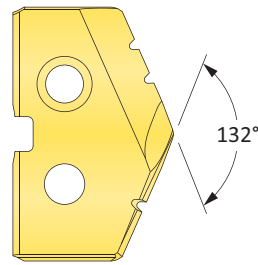

Standard

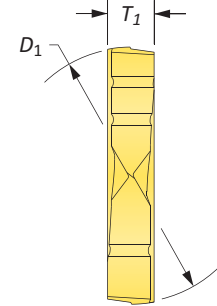
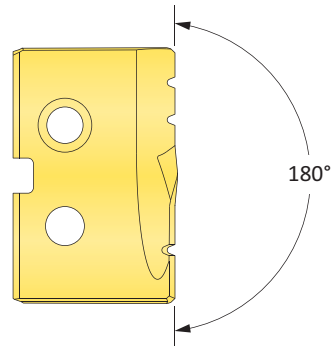

Flat Bottom



### Carbide Inserts – C2 (K20)

Series	Insert				Part No.		Flat Bottom Part No.
	Fractional Equivalent	D <sub>1</sub> inch	D <sub>1</sub> mm	T <sub>1</sub>	 TiN	 TiAlN	 TiN
1	45/64	0.7031	17.86	5/32	1C21T-.703	1C21A-.703	1C21T-.703-FB
	-	0.7087	18.00	5/32	1C21T-18	1C21A-18	1C21T-18-FB
	23/32	0.7188	18.26	5/32	1C21T-0023	1C21A-0023	1C21T-0023-FB
	-	0.7283	18.50	5/32	1C21T-18.5	1C21A-18.5	1C21T-18.5-FB
	47/64	0.7344	18.65	5/32	1C21T-.734	1C21A-.734	1C21T-.734-FB
	-	0.7480	19.00	5/32	1C21T-19	1C21A-19	1C21T-19-FB
	3/4	0.7500	19.05	5/32	1C21T-0024	1C21A-0024	1C21T-0024-FB
	49/64	0.7656	19.45	5/32	1C21T-.765	1C21A-.765	1C21T-.765-FB
	-	0.7677	19.50	5/32	1C21T-19.5	1C21A-19.5	1C21T-19.5-FB
	25/32	0.7813	19.84	5/32	1C21T-0025	1C21A-0025	1C21T-0025-FB
	-	0.7874	20.00	5/32	1C21T-20	1C21A-20	1C21T-20-FB
	51/64	0.7969	20.24	5/32	1C21T-.796	1C21A-.796	1C21T-.796-FB
	-	0.8010	20.34	5/32	1C21T-.801	1C21A-.801	1C21T-.801-FB
	-	0.8071	20.50	5/32	1C21T-20.5	1C21A-20.5	1C21T-20.5-FB
	13/16	0.8125	20.64	5/32	1C21T-0026	1C21A-0026	1C21T-0026-FB
	-	0.8268	21.00	5/32	1C21T-21	1C21A-21	1C21T-21-FB
	27/32	0.8438	21.43	5/32	1C21T-0027	1C21A-0027	1C21T-0027-FB
-	0.8465	21.50	5/32	1C21T-21.5	1C21A-21.5	1C21T-21.5-FB	
1.5	55/64	0.8594	21.83	5/32	1C21T-.859	1C21A-.859	1C21T-.859-FB
	-	0.8661	22.00	5/32	1C21T-22	1C21A-22	1C21T-22-FB
	7/8	0.8750	22.23	5/32	1C21T-0028	1C21A-0028	1C21T-0028-FB
	-	0.8858	22.50	5/32	1C21T-22.5	1C21A-22.5	1C21T-22.5-FB
	57/64	0.8906	22.62	5/32	1C21T-.890	1C21A-.890	1C21T-.890-FB
	-	0.9055	23.00	5/32	1C21T-23	1C21A-23	1C21T-23-FB
	29/32	0.9063	23.02	5/32	1C21T-0029	1C21A-0029	1C21T-0029-FB
	59/64	0.9219	23.42	5/32	1C21T-.921	1C21A-.921	1C21T-.921-FB
	-	0.9252	23.50	5/32	1C21T-23.5	1C21A-23.5	1C21T-23.5-FB
15/16	0.9375	23.81	5/32	1C21T-0030	1C21A-0030	1C21T-0030-FB	
-	0.9449	24.00	5/32	1C21T-24	1C21A-24	1C21T-24-FB	

**NOTE:** 1.5 series inserts fit into both 1 and 1.5 series holders. However, 1 series inserts ONLY fit into 1 series holders. See page A30: 7 for visual.

A30: 112 - 143

A30: 52 - 56

A30: 4 - 6

A30: 4 - 6

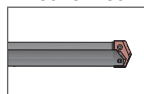
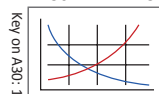

HI, HR, CR, TC, SK,  
NP, IN, RN, CN,  
AN, BR, CI, CP, NC,  
WC, BT

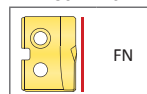

Coatings not listed above  
can be supplied as  
non-stocked standards.  
Process fees apply. →

TiN = 1C21T-XXXX	TiAlN = 1C21A-XXXX
TiCN = 1C21N-XXXX	AM200® = 1C21H-XXXX

Inserts sold in quantities of 2



## Original T-A Drill Inserts

1 Series | Carbide | Diameter Range: 0.690" - 0.960" (17.53mm - 24.38mm)

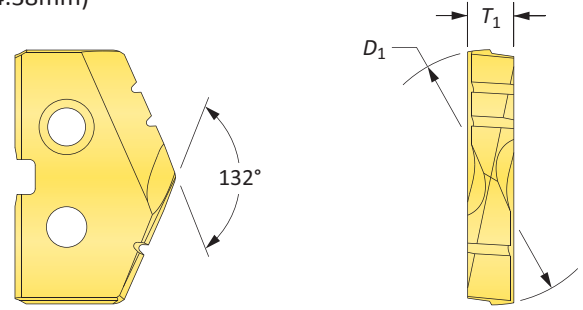

Carbide Inserts – C5 (P40) | C3 (K10) | N2

Series	Insert				C5 Part No.		C3 Part No.	N2 Part No.
	Fractional Equivalent	D <sub>1</sub> inch	D <sub>1</sub> mm	T <sub>1</sub>	TiN	TiAlN	TiAlN (Cast Iron)	Diamond Film*
1	45/64	0.7031	17.86	5/32	1C51T-.703	1C51A-.703	1C31A-.703-CI	1N21D-.703
	-	0.7087	18.00	5/32	1C51T-18	1C51A-18	1C31A-18-CI	1N21D-18
	23/32	0.7188	18.26	5/32	1C51T-0023	1C51A-0023	1C31A-0023-CI	1N21D-0023
	-	0.7283	18.50	5/32	1C51T-18.5	1C51A-18.5	1C31A-18.5-CI	1N21D-18.5
	47/64	0.7344	18.65	5/32	1C51T-.734	1C51A-.734	1C31A-.734-CI	1N21D-.734
	-	0.7480	19.00	5/32	1C51T-19	1C51A-19	1C31A-19-CI	1N21D-19
	3/4	0.7500	19.05	5/32	1C51T-0024	1C51A-0024	1C31A-0024-CI	1N21D-0024
	49/64	0.7656	19.45	5/32	1C51T-.765	1C51A-.765	1C31A-.765-CI	1N21D-.765
	-	0.7677	19.50	5/32	1C51T-19.5	1C51A-19.5	1C31A-19.5-CI	1N21D-19.5
	25/32	0.7813	19.84	5/32	1C51T-0025	1C51A-0025	1C31A-0025-CI	1N21D-0025
	-	0.7874	20.00	5/32	1C51T-20	1C51A-20	1C31A-20-CI	1N21D-20
	51/64	0.7969	20.24	5/32	1C51T-.796	1C51A-.796	1C31A-.796-CI	1N21D-.796
	-	0.8010	20.34	5/32	1C51T-.801	1C51A-.801	1C31A-.801-CI	1N21D-.801
	-	0.8071	20.50	5/32	1C51T-20.5	1C51A-20.5	1C31A-20.5-CI	1N21D-20.5
	13/16	0.8125	20.64	5/32	1C51T-0026	1C51A-0026	1C31A-0026-CI	1N21D-0026
	-	0.8268	21.00	5/32	1C51T-21	1C51A-21	1C31A-21-CI	1N21D-21
27/32	0.8438	21.43	5/32	1C51T-0027	1C51A-0027	1C31A-0027-CI	1N21D-0027	
-	0.8465	21.50	5/32	1C51T-21.5	1C51A-21.5	1C31A-21.5-CI	1N21D-21.5	
1.5	55/64	0.8594	21.83	5/32	1C51T-.859	1C51A-.859	1C31A-.859-CI	1N21D-.859
	-	0.8661	22.00	5/32	1C51T-22	1C51A-22	1C31A-22-CI	1N21D-22
	7/8	0.8750	22.23	5/32	1C51T-0028	1C51A-0028	1C31A-0028-CI	1N21D-0028
	-	0.8858	22.50	5/32	1C51T-22.5	1C51A-22.5	1C31A-22.5-CI	1N21D-22.5
	57/64	0.8906	22.62	5/32	1C51T-.890	1C51A-.890	1C31A-.890-CI	1N21D-.890
	-	0.9055	23.00	5/32	1C51T-23	1C51A-23	1C31A-23-CI	1N21D-23
	29/32	0.9063	23.02	5/32	1C51T-0029	1C51A-0029	1C31A-0029-CI	1N21D-0029
	59/64	0.9219	23.42	5/32	1C51T-.921	1C51A-.921	1C31A-.921-CI	1N21D-.921
	-	0.9252	23.50	5/32	1C51T-23.5	1C51A-23.5	1C31A-23.5-CI	1N21D-23.5
	15/16	0.9375	23.81	5/32	1C51T-0030	1C51A-0030	1C31A-0030-CI	1N21D-0030
-	0.9449	24.00	5/32	1C51T-24	1C51A-24	1C31A-24-CI	1N21D-24	

**NOTE:** 1.5 series inserts fit into both 1 and 1.5 series holders. However, 1 series inserts ONLY fit into 1 series holders. See page A30: 7 for visual.

\*Diamond Film is only available in standard geometry. For additional geometries, please contact Application Engineering.

A30: 112 - 143

A30: 52 - 56

A30: 4 - 6

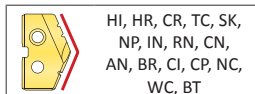
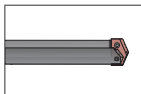
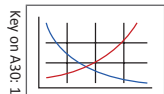

Coatings not listed above can be supplied as non-stocked standards. Process fees apply. →

Inserts sold in quantities of 2

TiN = 1C51T-XXXX	TiAlN = 1C51A-XXXX
TiCN = 1C51N-XXXX	AM200® = 1C51H-XXXX

## T-A Drill Insert Holders

1 Series | Flange Shank | Diameter Range: 0.690" - 0.960" (17.53mm - 24.38mm)

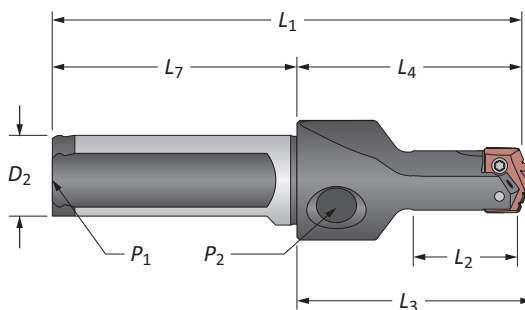
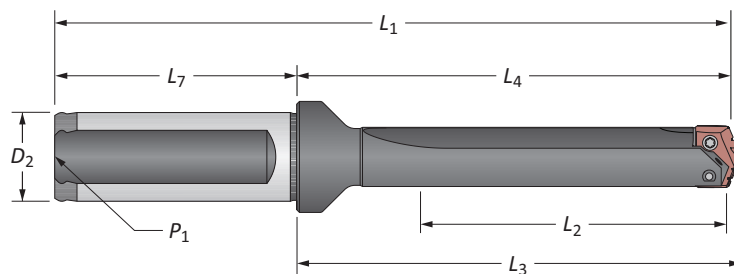

Stub Length

### Straight Flute

Series	Length	Body				Shank			Part No.	
		L <sub>2</sub>	L <sub>4</sub>	L <sub>3</sub>	L <sub>1</sub>	D <sub>2</sub>	L <sub>7</sub>	P <sub>1</sub>		
1	Stub	1-7/8	2-63/64	3-1/8	5-17/64	1	2-9/32	1/8	21010S-100F	
	Short	2-5/8	4-7/32	4-23/64	6-1/2	1	2-9/32	1/8	22010S-100F	
	Intermediate	4-5/8	6-3/32	6-15/64	8-3/8	1	2-9/32	1/8	23010S-100F	
	Standard	6-5/8	8-3/32	8-15/64	10-3/8	1	2-9/32	1/8	24010S-100F	
	Extended	10-5/8	12-3/32	12-15/64	14-3/8	1	2-9/32	1/8	<b>25010S-100F</b>	
1.5	Stub	2-1/4	3-31/64	3-5/8	5-49/64	1	2-9/32	1/8	21015S-100F	
	Short	2-5/8	4-7/32	4-23/64	6-1/2	1	2-9/32	1/8	22015S-100F	
	Intermediate	4-5/8	6-3/32	6-15/64	8-3/8	1	2-9/32	1/8	23015S-100F	
	Standard	6-5/8	8-3/32	8-15/64	10-3/8	1	2-9/32	1/8	24015S-100F	
	Extended	10-5/8	12-3/32	12-15/64	14-3/8	1	2-9/32	1/8	<b>25015S-100F</b>	
m	1	Stub	47.6	75.8	79.4	131.8	25.0	56.0	1/8*	21010S-25FM
		Short	66.7	107.2	110.7	163.2	25.0	56.0	1/8*	22010S-25FM
		XL	457.0	494.5	498.1	550.5	25.0	56.0	1/8*	<b>27010S-25FM</b>
		3XL	569.0	602.5	606.1	658.5	25.0	56.0	1/8*	<b>29010S-25FM</b>
	1.5	Stub	57.2	88.5	92.1	144.5	25.0	56.0	1/8*	21015S-25FM
		Short	66.7	107.2	110.7	163.2	25.0	56.0	1/8*	22015S-25FM

\*Metric thread to BSP and ISO 7-1

**NOTE:** Stub length holders have a 1/8" side pipe tap (P<sub>2</sub>)

**NOTE:** 1.5 series inserts fit into both 1 and 1.5 series holders. However, 1 series inserts ONLY fit into 1 series holders. See page A30: 7 for visual.

### Connection Accessories

Series	Insert Screws	Nylon Locking Screws	Insert Driver	Preset Torque Hand Driver	Replacement Tips	Admissible Tightening Torque*
1	7375-IP9-1	7375N-IP9-1	8IP-9	8IP-9TL	8IP-9B	27.0 in-lbs (305 N-cm)
1.5	739-IP9-1	739N-IP9-1	8IP-9	8IP-9TL	8IP-9B	27.0 in-lbs (305 N-cm)

\*Tightening torques are calculated with a friction coefficient of  $\mu = 0.14$  and develop 90% of ultimate yield strength

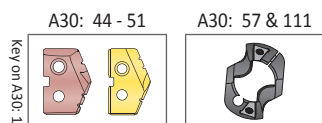

**i** = Imperial (in)

**m** = Metric (mm)

Screws sold in quantities of 10

**WARNING** Refer to Speed and Feed charts for recommended adjustments to speeds and feeds. Refer to page A30: 146 for deep hole drilling guidelines in this section of the catalog. Visit [www.alliedmachine.com/DeepHoleGuidelines](http://www.alliedmachine.com/DeepHoleGuidelines) for the most up-to-date information and procedures. Factory technical assistance is available for your specific applications through our Application Engineering Team.



## T-A Drill Insert Holders

1 Series | Flange Shank | Diameter Range: 0.690" - 0.960" (17.53mm - 24.38mm)

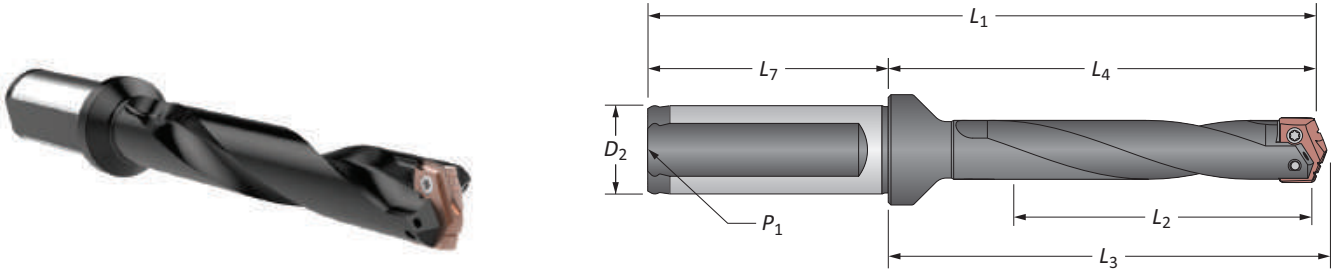

### Helical Flute

Series	Length	Body				Shank			Part No.
		L <sub>2</sub>	L <sub>4</sub>	L <sub>3</sub>	L <sub>1</sub>	D <sub>2</sub>	L <sub>7</sub>	P <sub>1</sub>	
i	Intermediate	4-5/8	6-3/32	6-15/64	8-3/8	1	2-9/32	1/8	23010H-100F
	Standard	6-5/8	8-3/32	8-15/64	10-3/8	1	2-9/32	1/8	24010H-100F
	Standard Plus	8-5/8	10-3/32	10-15/64	12-33/64	1	2-9/32	1/8	▲ 24510H-100F
	Extended	10-5/8	12-3/32	12-15/64	14-3/8	1	2-9/32	1/8	▲ 25010H-100F
	Long	14-3/8	15-27/32	15-63/64	18-17/64	1	2-9/32	1/8	▲ 26010H-100F
1.5	Intermediate	4-5/8	6-3/32	6-15/64	8-3/8	1	2-9/32	1/8	23015H-100F
	Standard	6-5/8	8-3/32	8-15/64	10-3/8	1	2-9/32	1/8	24015H-100F
	Extended	10-5/8	12-3/32	12-15/64	14-3/8	1	2-9/32	1/8	▲ 25015H-100F
ii	Intermediate	117.5	154.8	158.4	210.8	25.0	56.0	1/8*	23010H-25FM
	Standard	168.3	205.6	209.2	261.6	25.0	56.0	1/8*	24010H-25FM
	Standard Plus	219.0	256.3	259.9	312.3	25.0	56.0	1/8*	▲ 24510H-25FM
	Extended	269.9	307.2	310.8	363.2	25.0	56.0	1/8*	▲ 25010H-25FM
	Long	365.0	402.3	405.9	458.3	25.0	56.0	1/8*	▲ 26010H-25FM
	1.5	Intermediate	117.5	154.8	158.4	210.8	25.0	56.0	1/8*
Standard	168.3	205.6	209.2	261.6	25.0	56.0	1/8*	24015H-25FM	
Extended	269.9	307.2	310.8	363.2	25.0	56.0	1/8*	▲ 25015H-25FM	

\*Metric thread to BSP and ISO 7-1

**NOTE:** 1.5 series inserts fit into both 1 and 1.5 series holders. However, 1 series inserts ONLY fit into 1 series holders. See page A30: 7 for visual.

### Connection Accessories

Series	Insert Screws	Nylon Locking Screws	Insert Driver	Preset Torque Hand Driver	Replacement Tips	Admissible Tightening Torque*
1	7375-IP9-1	7375N-IP9-1	8IP-9	8IP-9TL	8IP-9B	27.0 in-lbs (305 N-cm)
1.5	739-IP9-1	739N-IP9-1	8IP-9	8IP-9TL	8IP-9B	27.0 in-lbs (305 N-cm)

\*Tightening torques are calculated with a friction coefficient of  $\mu = 0.14$  and develop 90% of ultimate yield strength

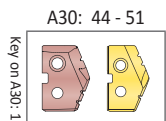

i = Imperial (in)  
m = Metric (mm)

Screws sold in quantities of 10

**WARNING** Refer to Speed and Feed charts for recommended adjustments to speeds and feeds. Refer to page A30: 146 for deep hole drilling guidelines in this section of the catalog. Visit [www.alliedmachine.com/DeepHoleGuidelines](http://www.alliedmachine.com/DeepHoleGuidelines) for the most up-to-date information and procedures. Factory technical assistance is available for your specific applications through our Application Engineering Team.

## T-A Drill Insert Holders

1 Series | Taper Shank | Diameter Range: 0.690" - 0.960" (17.53mm - 24.38mm)

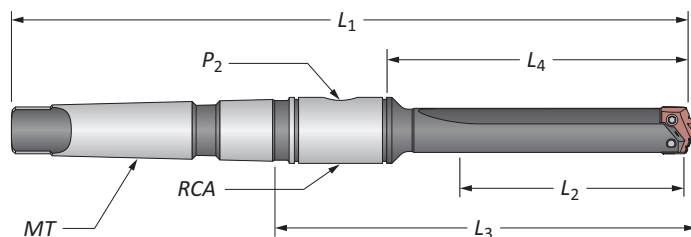

### Straight Flute

Series	Length	Body				Shank			Part No.	
		L <sub>2</sub>	L <sub>4</sub>	L <sub>3</sub>	L <sub>1</sub>	MT	P <sub>2</sub>	RCA		
1	Short	2-3/4	3-7/8	5-39/64	9-5/32	#3	1/8	2T-3SR	22010S-003I	
	Short	2-3/4	3-7/8	5-39/64	10-5/32	#4	1/8	2T-3SR	22010S-004I	
	Intermediate	4-3/4	5-7/8	7-39/64	11-5/32	#3	1/8	2T-3SR	23010S-003I	
	Standard	6-3/4	7-7/8	9-39/64	13-5/32	#3	1/8	2T-3SR	24010S-003I	
	Standard	6-3/4	7-7/8	9-39/64	14-5/32	#4	1/8	2T-3SR	24010S-004I	
1.5	Extended	10-3/4	11-7/8	13-39/64	17-5/32	#3	1/8	2T-3SR	25010S-003I	
	Short	2-3/4	3-7/8	5-39/64	9-5/32	#3	1/8	2T-3SR	22015S-003I	
	Short	2-3/4	3-7/8	5-39/64	10-5/32	#4	1/8	2T-3SR	22015S-004I	
	Intermediate	4-3/4	5-7/8	7-39/64	11-5/32	#3	1/8	2T-3SR	23015S-003I	
	Standard	6-3/4	7-7/8	9-39/64	13-5/32	#3	1/8	2T-3SR	24015S-003I	
	Standard	6-3/4	7-7/8	9-39/64	14-5/32	#4	1/8	2T-3SR	24015S-004I	
m	1	Short	69.8	98.4	142.5	232.5	#3**	1/8*	2T-3SRM	22010S-003M
	1.5	Short	69.8	98.4	142.5	232.5	#3**	1/8*	2T-3SRM	22015S-003M

\*Metric thread to BSP and ISO 7-1

\*\*Per ISO 296 type BEK

**NOTE:** 1.5 series inserts fit into both 1 and 1.5 series holders. However, 1 series inserts ONLY fit into 1 series holders. See page A30: 7 for visual.

### Connection Accessories

Series	Insert Screws	Nylon Locking Screws	Insert Driver	Preset Torque Hand Driver	Replacement Tips	Admissible Tightening Torque*
1	7375-IP9-1	7375N-IP9-1	8IP-9	8IP-9TL	8IP-9B	27.0 in-lbs (305 N-cm)
1.5	739-IP9-1	739N-IP9-1	8IP-9	8IP-9TL	8IP-9B	27.0 in-lbs (305 N-cm)

\*Tightening torques are calculated with a friction coefficient of  $\mu = 0.14$  and develop 90% of ultimate yield strength

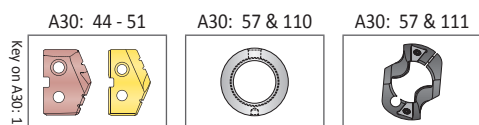

i = Imperial (in)

m = Metric (mm)

Screws sold in quantities of 10

**WARNING** Refer to Speed and Feed charts for recommended adjustments to speeds and feeds. Refer to page A30: 146 for deep hole drilling guidelines in this section of the catalog. Visit [www.alliedmachine.com/DeepHoleGuidelines](http://www.alliedmachine.com/DeepHoleGuidelines) for the most up-to-date information and procedures. Factory technical assistance is available for your specific applications through our Application Engineering Team.

## T-A Drill Insert Holders

1 Series | Taper Shank | Diameter Range: 0.690" - 0.960" (17.53mm - 24.38mm)

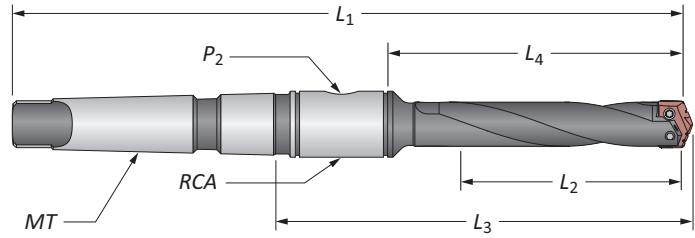

### Helical Flute

Series	Length	Body				Shank			Part No.	
		L <sub>2</sub>	L <sub>4</sub>	L <sub>3</sub>	L <sub>1</sub>	MT	P <sub>2</sub>	RCA		
i	1	Intermediate	4-3/4	5-7/8	7-39/64	11-5/32	#3	1/8	2T-3SR	23010H-003I
		Standard	6-3/4	7-7/8	9-39/64	13-5/32	#3	1/8	2T-3SR	24010H-003I
		Standard	6-3/4	7-7/8	9-43/64	14-5/32	#4	1/8	2T-3SR	24010H-004I
		Extended	10-3/4	11-7/8	13-39/64	17-5/32	#3	1/8	2T-3SR	⚠ 25010H-003I
i	1.5	Intermediate	4-3/4	5-7/8	7-39/64	11-5/32	#3	1/8	2T-3SR	23015H-003I
		Standard	6-3/4	7-7/8	9-39/64	13-5/32	#3	1/8	2T-3SR	24015H-003I
		Standard	6-3/4	7-7/8	9-43/64	14-5/32	#4	1/8	2T-3SR	24015H-004I
		Extended	10-3/4	11-7/8	13-39/64	17-5/32	#3	1/8	2T-3SR	⚠ 25015H-003I
m	1	Intermediate	120.7	149.2	193.3	283.3	#3**	1/8*	2T-3SRM	23010H-003M
		Standard	171.5	200.0	244.1	334.2	#3**	1/8*	2T-3SRM	24010H-003M
		Extended	273.1	301.6	345.7	435.8	#3**	1/8*	2T-3SRM	⚠ 25010H-003M
	1.5	Intermediate	120.7	149.2	193.3	283.3	#3**	1/8*	2T-3SRM	23015H-003M
		Standard	171.5	200.0	244.1	334.2	#3**	1/8*	2T-3SRM	24015H-003M
		Extended	273.1	301.6	345.7	435.8	#3**	1/8*	2T-3SRM	⚠ 25015H-003M

\*Metric thread to BSP and ISO 7-1

\*\*Per ISO 296 type BEK

**NOTE:** 1.5 series inserts fit into both 1 and 1.5 series holders. However, 1 series inserts ONLY fit into 1 series holders. See page A30: 7 for visual.

### Connection Accessories

Series	Insert Screws	Nylon Locking Screws	Insert Driver	Preset Torque Hand Driver	Replacement Tips	Admissible Tightening Torque*
1	7375-IP9-1	7375N-IP9-1	8IP-9	8IP-9TL	8IP-9B	27.0 in-lbs (305 N-cm)
1.5	739-IP9-1	739N-IP9-1	8IP-9	8IP-9TL	8IP-9B	27.0 in-lbs (305 N-cm)

\*Tightening torques are calculated with a friction coefficient of  $\mu = 0.14$  and develop 90% of ultimate yield strength

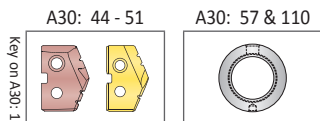

i = Imperial (in)  
m = Metric (mm)

Screws sold in quantities of 10

**⚠ WARNING** Refer to Speed and Feed charts for recommended adjustments to speeds and feeds. Refer to page A30: 146 for deep hole drilling guidelines in this section of the catalog. Visit [www.alliedmachine.com/DeepHoleGuidelines](http://www.alliedmachine.com/DeepHoleGuidelines) for the most up-to-date information and procedures. Factory technical assistance is available for your specific applications through our Application Engineering Team.

## T-A Drill Insert Holders

1 Series | Straight Shank | Diameter Range: 0.690" - 0.960" (17.53mm - 24.38mm)

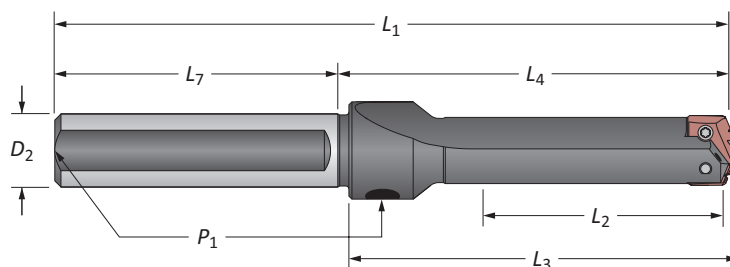

### Straight Flute

Series	Length	Body				Shank			Part No.
		L <sub>2</sub>	L <sub>4</sub>	L <sub>3</sub>	L <sub>1</sub>	D <sub>2</sub>	L <sub>7</sub>	P <sub>1</sub>	
1	Short	2-5/8	3-7/8	4-1/64	6-7/8	3/4	3	1/8	22010S-075L
	Short	2-5/8	3-7/8	4-1/64	6-7/8	1	3	1/8	22010S-100L
	Intermediate	4-5/8	5-7/8	6-1/64	8-7/8	1	3	1/8	23010S-100L
	Standard	6-5/8	7-7/8	8-1/64	10-7/8	3/4	3	1/8	24010S-075L
	Standard	6-5/8	7-7/8	8-1/64	10-7/8	1	3	1/8	24010S-100L
	Extended	10-5/8	11-7/8	12-1/64	14-7/8	1	3	1/8	25010S-100L
	XL	18	19-1/4	19-25/64	22-1/4	1	3	1/8	27010S-100L
1.5	3XL	22-1/4	23-1/2	23-41/64	26-1/2	1	3	1/8	29010S-100L
	Short	2-5/8	3-7/8	4-1/64	6-7/8	3/4	3	1/8*	22015S-075L
	Short	2-5/8	3-7/8	4-1/64	6-7/8	1	3	1/8*	22015S-100L
	Intermediate	4-5/8	5-7/8	6-1/64	8-7/8	1	3	1/8*	23015S-100L
	Standard	6-5/8	7-7/8	8-1/64	10-7/8	3/4	3	1/8*	24015S-075L
	Standard	6-5/8	7-7/8	8-1/64	10-7/8	1	3	1/8*	24015S-100L
	Extended	10-5/8	11-7/8	12-1/64	14-7/8	1	3	1/8*	25015S-100L

**NOTE:** 1.5 series inserts fit into both 1 and 1.5 series holders. However, 1 series inserts ONLY fit into 1 series holders. See page A30: 7 for visual.

### Connection Accessories

Series	Insert Screws	Nylon Locking Screws	Insert Driver	Preset Torque Hand Driver	Replacement Tips	Admissible Tightening Torque*
1	7375-IP9-1	7375N-IP9-1	8IP-9	8IP-9TL	8IP-9B	27.0 in-lbs (305 N-cm)
1.5	739-IP9-1	739N-IP9-1	8IP-9	8IP-9TL	8IP-9B	27.0 in-lbs (305 N-cm)

\*Tightening torques are calculated with a friction coefficient of  $\mu = 0.14$  and develop 90% of ultimate yield strength

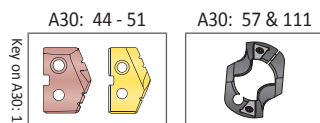

Key on A30: 1

i = Imperial (in)  
m = Metric (mm)

Screws sold in quantities of 10

**WARNING** Refer to Speed and Feed charts for recommended adjustments to speeds and feeds. Refer to page A30: 146 for deep hole drilling guidelines in this section of the catalog. Visit [www.alliedmachine.com/DeepHoleGuidelines](http://www.alliedmachine.com/DeepHoleGuidelines) for the most up-to-date information and procedures. Factory technical assistance is available for your specific applications through our Application Engineering Team.

T-A Drill Accessories

1 Series | Chamfer Rings | Rotary Coolant Adapters | Torx® Plus Screws |

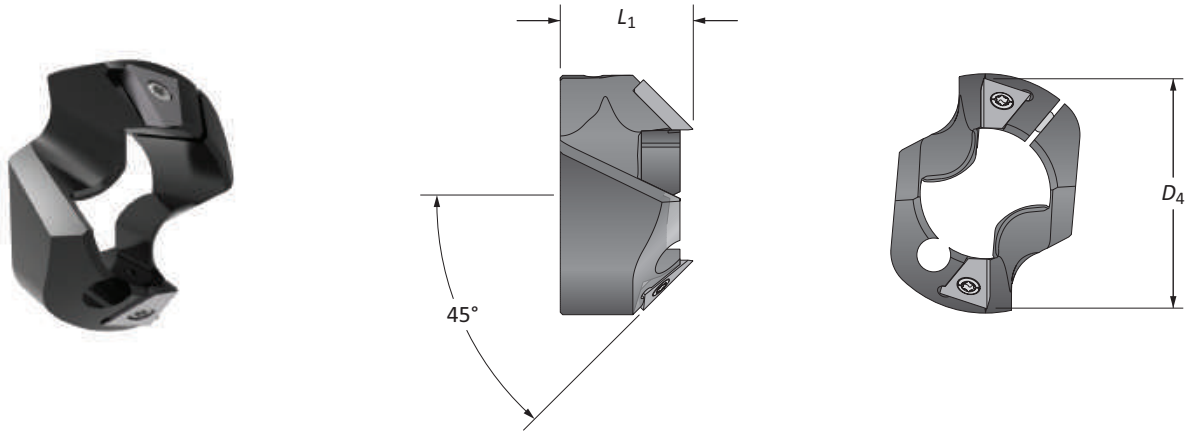

T-ACR 45 Chamfer Ring

Holder Series	D <sub>1</sub> Range	Chamfer Ring		Part No.	Insert Part No.	Insert Screw	Insert Driver	Clamping Screw	Insert Driver
		D <sub>4</sub>	L <sub>1</sub>						
1	0.6900 - 0.9600	1-3/64	51/64	T-ACR-45-1	T-ACRI-45-B-C5A	7255-IP8-1	8IP-8	7495-IP15-1	8IP-15
1.5	0.8540 - 0.9600	1-1/8	57/64	T-ACR-45-1.5	T-ACRI-45-B-C5A	7255-IP8-1	8IP-8	7495-IP15-1	8IP-15

Rotary Coolant Adapter (RCA) and Accessories

ID	OD	L <sub>1</sub>	Driving Rod Thread	P <sub>1</sub>	Part No.	RCA O-Rings	
						Kit Part No.**	Replacements
1	2-1/8	1-1/8	5/16-18	1/8	<b>2T-3SR</b>	2T1-3SR	2T1-3OR-10
25.40	53.97	28.57	M8 x 1.25	1/8*	<b>2T-3SRM</b>	2T1-3SR	2T1-3OR-10

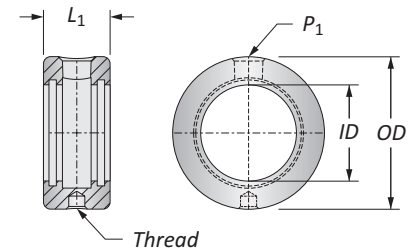

\*Thread to BSP and ISO 7-1

\*\*RCA Repair Kit includes (2) O-rings, (2) snap rings, and (2) thrust washers

▲ Refer to page A30: 110 for proper RCA assembly and safety information

Connection Accessories

Series	Insert Screws	Nylon Locking Screws	Insert Driver	Preset Torque Hand Driver	Replacement Tips	Admissible Tightening Torque*
1	7375-IP9-1	7375N-IP9-1	8IP-9	8IP-9TL	8IP-9B	27.0 in-lbs (305 N-cm)
1.5	739-IP9-1	739N-IP9-1	8IP-9	8IP-9TL	8IP-9B	27.0 in-lbs (305 N-cm)

\*Tightening torques are calculated with a friction coefficient of  $\mu = 0.14$  and develop 90% of ultimate yield strength

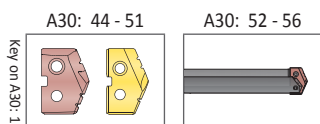

ⓘ = Imperial (in)  
 Ⓜ = Metric (mm)

Chamfer Ring Inserts sold separately  
 Screws sold in packs of 10  
 O-rings sold in packs of 10

**WARNING** RCA rotation during drilling can cause hose and/or hose fitting failure, machinery damage, and/or serious injury. To prevent, use RCA and positive stop studs when drilling. Factory technical assistance is also available for your specific applications.



A DRILLING  
 B BORING  
 C REAMING  
 D BURNISHING  
 E THREADING  
 X SPECIALS

## GEN2 T-A Drill Inserts

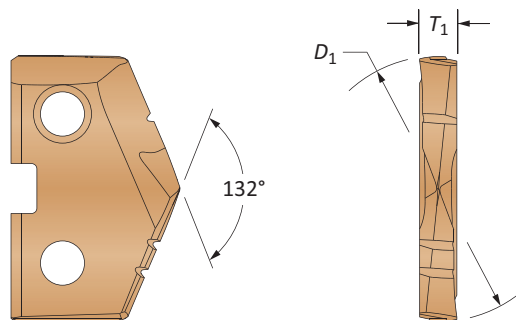
2 Series | Diameter Range: 0.961" - 1.380" (24.41mm - 35.05mm)



HSS Inserts – Super Cobalt • Carbide Inserts – C2 (K20) | C1 (K35)

Series	Fractional Equivalent	Insert			HSS Part No.	Carbide Part No.	
		$D_1$ inch	$D_1$ mm	$T_1$	 AM200® Super Cobalt	 AM300® C2 (K20)	 AM300® C1 (K35)
2	-	0.9646	24.50	3/16	452H-24.5	4C22P-24.5	4C12P-24.5
	31/32	0.9688	24.61	3/16	452H-0031	4C22P-0031	4C12P-0031
	-	0.9760	24.79	3/16	452H-.976	4C22P-.976	4C12P-.976
	63/64	0.9843	25.00	3/16	452H-25	4C22P-25	4C12P-25
	1	1.0000	25.40	3/16	452H-0100	4C22P-0100	4C12P-0100
	-	1.0039	25.50	3/16	452H-25.5	4C22P-25.5	4C12P-25.5
	1-1/64	1.0156	25.80	3/16	452H-1.015	4C22P-1.015	4C12P-1.015
	-	1.0236	26.00	3/16	452H-26	4C22P-26	4C12P-26
	1-1/32	1.0313	26.19	3/16	452H-0101	4C22P-0101	4C12P-0101
	-	1.0433	26.50	3/16	452H-26.5	4C22P-26.5	4C12P-26.5
	1-3/64	1.0469	26.59	3/16	452H-1.046	4C22P-1.046	4C12P-1.046
	1-1/16	1.0625	26.99	3/16	452H-0102	4C22P-0102	4C12P-0102
	-	1.0630	27.00	3/16	452H-27	4C22P-27	4C12P-27
	-	1.0827	27.50	3/16	452H-27.5	4C22P-27.5	4C12P-27.5
	1-3/32	1.0938	27.78	3/16	452H-0103	4C22P-0103	4C12P-0103
	-	1.1024	28.00	3/16	452H-28	4C22P-28	4C12P-28
	1-7/64	1.1094	28.18	3/16	452H-1.109	4C22P-1.109	4C12P-1.109
	-	1.1220	28.50	3/16	452H-28.5	4C22P-28.5	4C12P-28.5
	1-1/8	1.1250	28.58	3/16	452H-0104	4C22P-0104	4C12P-0104
	-	1.1417	29.00	3/16	452H-29	4C22P-29	4C12P-29
1-5/32	1.1563	29.37	3/16	452H-0105	4C22P-0105	4C12P-0105	
-	1.1614	29.50	3/16	452H-29.5	4C22P-29.5	4C12P-29.5	
-	1.1811	30.00	3/16	452H-30	4C22P-30	4C12P-30	
2.5	1-3/16	1.1875	30.16	3/16	452H-0106	4C22P-0106	4C12P-0106
	-	1.2008	30.50	3/16	452H-30.5	4C22P-30.5	4C12P-30.5
	1-7/32	1.2188	30.96	3/16	452H-0107	4C22P-0107	4C12P-0107
	-	1.2205	31.00	3/16	452H-31	4C22P-31	4C12P-31
	-	1.2260	31.14	3/16	452H-1.226	4C22P-1.226	4C12P-1.226
	-	1.2310	31.26	3/16	452H-1.231	4C22P-1.231	4C12P-1.231
	-	1.2340	31.34	3/16	452H-1.234	4C22P-1.234	4C12P-1.234
	-	1.2402	31.50	3/16	452H-31.5	4C22P-31.5	4C12P-31.5
	1-1/4	1.2500	31.75	3/16	452H-0108	4C22P-0108	4C12P-0108
	-	1.2598	32.00	3/16	452H-32	4C22P-32	4C12P-32
	-	1.2795	32.50	3/16	452H-32.5	4C22P-32.5	4C12P-32.5
	1-9/32	1.2813	32.54	3/16	452H-0109	4C22P-0109	4C12P-0109
	-	1.2992	33.00	3/16	452H-33	4C22P-33	4C12P-33
	1-5/16	1.3125	33.34	3/16	452H-0110	4C22P-0110	4C12P-0110
	-	1.3189	33.50	3/16	452H-33.5	4C22P-33.5	4C12P-33.5
	-	1.3386	34.00	3/16	452H-34	4C22P-34	4C12P-34
	1-11/32	1.3438	34.13	3/16	452H-0111	4C22P-0111	4C12P-0111
	-	1.3582	34.50	3/16	452H-34.5	4C22P-34.5	4C12P-34.5
	1-3/8	1.3750	34.93	3/16	452H-0112	4C22P-0112	4C12P-0112
	-	1.3780	35.00	3/16	452H-35	4C22P-35	4C12P-35

**NOTE:** 2.5 series inserts fit into both 2 and 2.5 series holders. However, 2 series inserts ONLY fit into 2 series holders. See page A30: 7 for visual.

Inserts sold in quantities of 2

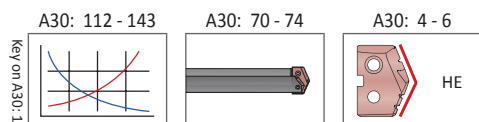

Coatings not listed above can be supplied as non-stocked standards. Process fees apply. →



TiN = 452T-XXXX	TiAlN = 452A-XXXX
TiCN = 452N-XXXX	AM200® = 452H-XXXX

Original T-A Drill Inserts

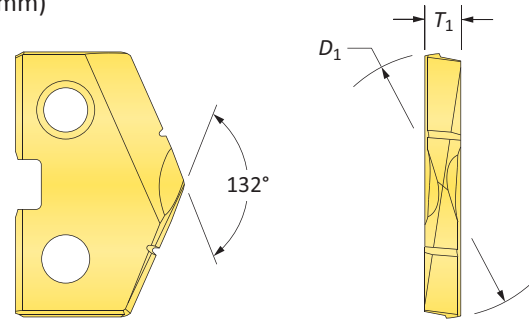
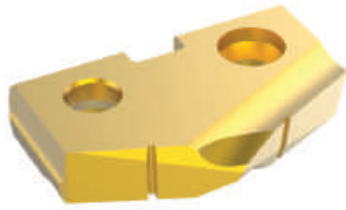
2 Series | HSS | Diameter Range: 0.961" - 1.380" (24.41mm - 35.05mm)



HSS Inserts – Premium Cobalt

Series	Fractional Equivalent	Insert			Part No.		
		D <sub>1</sub> inch	D <sub>1</sub> mm	T <sub>1</sub>	 TiN	 TiAlN	 TiCN
2	-	0.9646	24.50	3/16	182T-24.5	182A-24.5	182N-24.5
	31/32	0.9688	24.61	3/16	182T-0031	182A-0031	182N-0031
	-	0.9760	24.79	3/16	182T-.976	182A-.976	182N-.976
	63/64	0.9843	25.00	3/16	182T-25	182A-25	182N-25
	1	1.0000	25.40	3/16	182T-0100	182A-0100	182N-0100
	-	1.0039	25.50	3/16	182T-25.5	182A-25.5	182N-25.5
	1-1/64	1.0156	25.80	3/16	182T-1.015	182A-1.015	182N-1.015
	-	1.0236	26.00	3/16	182T-26	182A-26	182N-26
	1-1/32	1.0313	26.19	3/16	182T-0101	182A-0101	182N-0101
	-	1.0433	26.50	3/16	182T-26.5	182A-26.5	182N-26.5
	1-3/64	1.0469	26.59	3/16	182T-1.046	182A-1.046	182N-1.046
	1-1/16	1.0625	26.99	3/16	182T-0102	182A-0102	182N-0102
	-	1.0630	27.00	3/16	182T-27	182A-27	182N-27
	-	1.0827	27.50	3/16	182T-27.5	182A-27.5	182N-27.5
	1-3/32	1.0938	27.78	3/16	182T-0103	182A-0103	182N-0103
	-	1.1024	28.00	3/16	182T-28	182A-28	182N-28
	1-7/64	1.1094	28.18	3/16	182T-1.109	182A-1.109	182N-1.109
	-	1.1220	28.50	3/16	182T-28.5	182A-28.5	182N-28.5
	1-1/8	1.1250	28.58	3/16	182T-0104	182A-0104	182N-0104
	-	1.1417	29.00	3/16	182T-29	182A-29	182N-29
1-5/32	1.1563	29.37	3/16	182T-0105	182A-0105	182N-0105	
-	1.1614	29.50	3/16	182T-29.5	182A-29.5	182N-29.5	
-	1.1811	30.00	3/16	182T-30	182A-30	182N-30	
2.5	1-3/16	1.1875	30.16	3/16	182T-0106	182A-0106	182N-0106
	-	1.2008	30.50	3/16	182T-30.5	182A-30.5	182N-30.5
	1-7/32	1.2188	30.96	3/16	182T-0107	182A-0107	182N-0107
	-	1.2205	31.00	3/16	182T-31	182A-31	182N-31
	-	1.2260	31.14	3/16	182T-1.226	182A-1.226	182N-1.226
	-	1.2310	31.26	3/16	182T-1.231	182A-1.231	182N-1.231
	-	1.2340	31.34	3/16	182T-1.234	182A-1.234	182N-1.234
	-	1.2402	31.50	3/16	182T-31.5	182A-31.5	182N-31.5
	1-1/4	1.2500	31.75	3/16	182T-0108	182A-0108	182N-0108
	-	1.2598	32.00	3/16	182T-32	182A-32	182N-32
	-	1.2795	32.50	3/16	182T-32.5	182A-32.5	182N-32.5
	1-9/32	1.2813	32.54	3/16	182T-0109	182A-0109	182N-0109
	-	1.2992	33.00	3/16	182T-33	182A-33	182N-33
	1-5/16	1.3125	33.34	3/16	182T-0110	182A-0110	182N-0110
	-	1.3189	33.50	3/16	182T-33.5	182A-33.5	182N-33.5
	-	1.3386	34.00	3/16	182T-34	182A-34	182N-34
	1-11/32	1.3438	34.13	3/16	182T-0111	182A-0111	182N-0111
	-	1.3582	34.50	3/16	182T-34.5	182A-34.5	182N-34.5
	1-3/8	1.3750	34.93	3/16	182T-0112	182A-0112	182N-0112
	-	1.3780	35.00	3/16	182T-35	182A-35	182N-35

NOTE: 2.5 series inserts fit into both 2 and 2.5 series holders. However, 2 series inserts ONLY fit into 2 series holders. See page A30: 7 for visual.

A30: 112 - 143

A30: 70 - 74

A30: 4 - 6

HI, HR, CR, TC, SK, NP, IN, RN, CN, AN, BR, CI, CP, NC, WC

Coatings not listed above can be supplied as non-stocked standards. Process fees apply. →

TiN = 182T-XXXX	TiAlN = 182A-XXXX
TiCN = 182N-XXXX	AM200® = 182H-XXXX



Inserts sold in quantities of 2

## Original T-A Drill Inserts

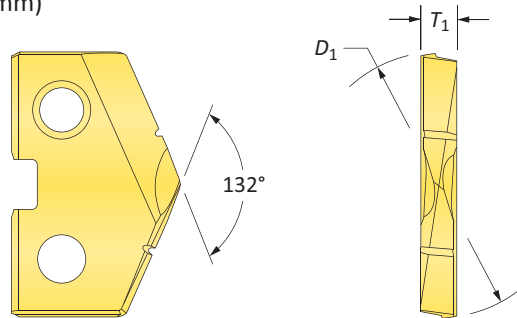
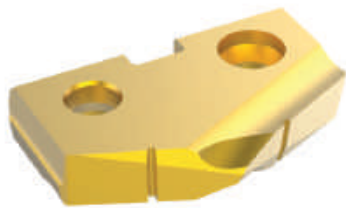
2 Series | HSS | Diameter Range: 0.961" - 1.380" (24.41mm - 35.05mm)



### HSS Inserts – Super Cobalt

Series	Fractional Equivalent	Insert			Part No.		
		$D_1$ inch	$D_1$ mm	$T_1$	 TiN	 TiAlN	 TiCN
2	-	0.9646	24.50	3/16	152T-24.5	152A-24.5	152N-24.5
	31/32	0.9688	24.61	3/16	152T-0031	152A-0031	152N-0031
	-	0.9760	24.79	3/16	152T-.976	152A-.976	152N-.976
	63/64	0.9843	25.00	3/16	152T-25	152A-25	152N-25
	1	1.0000	25.40	3/16	152T-0100	152A-0100	152N-0100
	-	1.0039	25.50	3/16	152T-25.5	152A-25.5	152N-25.5
	1-1/64	1.0156	25.80	3/16	152T-1.015	152A-1.015	152N-1.015
	-	1.0236	26.00	3/16	152T-26	152A-26	152N-26
	1-1/32	1.0313	26.19	3/16	152T-0101	152A-0101	152N-0101
	-	1.0433	26.50	3/16	152T-26.5	152A-26.5	152N-26.5
	1-3/64	1.0469	26.59	3/16	152T-1.046	152A-1.046	152N-1.046
	1-1/16	1.0625	26.99	3/16	152T-0102	152A-0102	152N-0102
	-	1.0630	27.00	3/16	152T-27	152A-27	152N-27
	-	1.0827	27.50	3/16	152T-27.5	152A-27.5	152N-27.5
	1-3/32	1.0938	27.78	3/16	152T-0103	152A-0103	152N-0103
	-	1.1024	28.00	3/16	152T-28	152A-28	152N-28
	1-7/64	1.1094	28.18	3/16	152T-1.109	152A-1.109	152N-1.109
	-	1.1220	28.50	3/16	152T-28.5	152A-28.5	152N-28.5
	1-1/8	1.1250	28.58	3/16	152T-0104	152A-0104	152N-0104
	-	1.1417	29.00	3/16	152T-29	152A-29	152N-29
1-5/32	1.1563	29.37	3/16	152T-0105	152A-0105	152N-0105	
-	1.1614	29.50	3/16	152T-29.5	152A-29.5	152N-29.5	
-	1.1811	30.00	3/16	152T-30	152A-30	152N-30	
2.5	1-3/16	1.1875	30.16	3/16	152T-0106	152A-0106	152N-0106
	-	1.2008	30.50	3/16	152T-30.5	152A-30.5	152N-30.5
	1-7/32	1.2188	30.96	3/16	152T-0107	152A-0107	152N-0107
	-	1.2205	31.00	3/16	152T-31	152A-31	152N-31
	-	1.2260	31.14	3/16	152T-1.226	152A-1.226	152N-1.226
	-	1.2310	31.26	3/16	152T-1.231	152A-1.231	152N-1.231
	-	1.2340	31.34	3/16	152T-1.234	152A-1.234	152N-1.234
	-	1.2402	31.50	3/16	152T-31.5	152A-31.5	152N-31.5
	1-1/4	1.2500	31.75	3/16	152T-0108	152A-0108	152N-0108
	-	1.2598	32.00	3/16	152T-32	152A-32	152N-32
	-	1.2795	32.50	3/16	152T-32.5	152A-32.5	152N-32.5
	1-9/32	1.2813	32.54	3/16	152T-0109	152A-0109	152N-0109
	-	1.2992	33.00	3/16	152T-33	152A-33	152N-33
	1-5/16	1.3125	33.34	3/16	152T-0110	152A-0110	152N-0110
	-	1.3189	33.50	3/16	152T-33.5	152A-33.5	152N-33.5
	-	1.3386	34.00	3/16	152T-34	152A-34	152N-34
	1-11/32	1.3438	34.13	3/16	152T-0111	152A-0111	152N-0111
	-	1.3582	34.50	3/16	152T-34.5	152A-34.5	152N-34.5
	1-3/8	1.3750	34.93	3/16	152T-0112	152A-0112	152N-0112
	-	1.3780	35.00	3/16	152T-35	152A-35	152N-35

**NOTE:** 2.5 series inserts fit into both 2 and 2.5 series holders. However, 2 series inserts ONLY fit into 2 series holders. See page A30: 7 for visual.

Inserts sold in quantities of 2

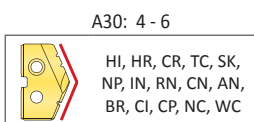
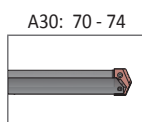
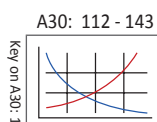

Coatings not listed above  
can be supplied as  
non-stocked standards.  
Process fees apply. →

TiN = 152T-XXXX	TiAlN = 152A-XXXX
TiCN = 152N-XXXX	AM200® = 152H-XXXX





Original T-A Drill Inserts



2 Series | HSS | Diameter Range: 0.961" - 1.380" (24.41mm - 35.05mm)

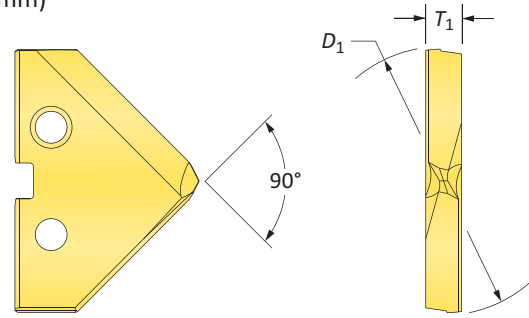

90° Spot & Chamfer



HSS Inserts – Super Cobalt

Series	Fractional Equivalent	Insert			90° Spot & Chamfer Part No.		
		D <sub>1</sub> inch	D <sub>1</sub> mm	T <sub>1</sub>	 TiN	 TiAlN	 TiCN
2	–	0.9646	24.50	3/16	152T-24.5-SP	152A-24.5-SP	152N-24.5-SP
	31/32	0.9688	24.61	3/16	152T-0031-SP	152A-0031-SP	152N-0031-SP
	–	0.9760	24.79	3/16	152T-.976-SP	152A-.976-SP	152N-.976-SP
	63/64	0.9843	25.00	3/16	152T-25-SP	152A-25-SP	152N-25-SP
	1	1.0000	25.40	3/16	152T-0100-SP	152A-0100-SP	152N-0100-SP
	–	1.0039	25.50	3/16	152T-25.5-SP	152A-25.5-SP	152N-25.5-SP
	1-1/64	1.0156	25.80	3/16	152T-1.015-SP	152A-1.015-SP	152N-1.015-SP
	–	1.0236	26.00	3/16	152T-26-SP	152A-26-SP	152N-26-SP
	1-1/32	1.0313	26.19	3/16	152T-0101-SP	152A-0101-SP	152N-0101-SP
	–	1.0433	26.50	3/16	152T-26.5-SP	152A-26.5-SP	152N-26.5-SP
	1-3/64	1.0469	26.59	3/16	152T-1.046-SP	152A-1.046-SP	152N-1.046-SP
	1-1/16	1.0625	26.99	3/16	152T-0102-SP	152A-0102-SP	152N-0102-SP
	–	1.0630	27.00	3/16	152T-27-SP	152A-27-SP	152N-27-SP
	–	1.0827	27.50	3/16	152T-27.5-SP	152A-27.5-SP	152N-27.5-SP
	1-3/32	1.0938	27.78	3/16	152T-0103-SP	152A-0103-SP	152N-0103-SP
	–	1.1024	28.00	3/16	152T-28-SP	152A-28-SP	152N-28-SP
	1-7/64	1.1094	28.18	3/16	152T-1.109-SP	152A-1.109-SP	152N-1.109-SP
	–	1.1220	28.50	3/16	152T-28.5-SP	152A-28.5-SP	152N-28.5-SP
	1-1/8	1.1250	28.58	3/16	152T-0104-SP	152A-0104-SP	152N-0104-SP
	–	1.1417	29.00	3/16	152T-29-SP	152A-29-SP	152N-29-SP
1-5/32	1.1563	29.37	3/16	152T-0105-SP	152A-0105-SP	152N-0105-SP	
–	1.1614	29.50	3/16	152T-29.5-SP	152A-29.5-SP	152N-29.5-SP	
–	1.1811	30.00	3/16	152T-30-SP	152A-30-SP	152N-30-SP	
2.5	1-3/16	1.1875	30.16	3/16	152T-0106-SP	152A-0106-SP	152N-0106-SP
	–	1.2008	30.50	3/16	152T-30.5-SP	152A-30.5-SP	152N-30.5-SP
	1-7/32	1.2188	30.96	3/16	152T-0107-SP	152A-0107-SP	152N-0107-SP
	–	1.2205	31.00	3/16	152T-31-SP	152A-31-SP	152N-31-SP
	–	1.2260	31.14	3/16	152T-1.226-SP	152A-1.226-SP	152N-1.226-SP
	–	1.2310	31.26	3/16	152T-1.231-SP	152A-1.231-SP	152N-1.231-SP
	–	1.2340	31.34	3/16	152T-1.234-SP	152A-1.234-SP	152N-1.234-SP
	–	1.2402	31.50	3/16	152T-31.5-SP	152A-31.5-SP	152N-31.5-SP
	1-1/4	1.2500	31.75	3/16	152T-0108-SP	152A-0108-SP	152N-0108-SP
	–	1.2598	32.00	3/16	152T-32-SP	152A-32-SP	152N-32-SP
	–	1.2795	32.50	3/16	152T-32.5-SP	152A-32.5-SP	152N-32.5-SP
	1-9/32	1.2813	32.54	3/16	152T-0109-SP	152A-0109-SP	152N-0109-SP
	–	1.2992	33.00	3/16	152T-33-SP	152A-33-SP	152N-33-SP
	1-5/16	1.3125	33.34	3/16	152T-0110-SP	152A-0110-SP	152N-0110-SP
	–	1.3189	33.50	3/16	152T-33.5-SP	152A-33.5-SP	152N-33.5-SP
	–	1.3386	34.00	3/16	152T-34-SP	152A-34-SP	152N-34-SP
	1-11/32	1.3438	34.13	3/16	152T-0111-SP	152A-0111-SP	152N-0111-SP
	–	1.3582	34.50	3/16	152T-34.5-SP	152A-34.5-SP	152N-34.5-SP
	1-3/8	1.3750	34.93	3/16	152T-0112-SP	152A-0112-SP	152N-0112-SP
	–	1.3780	35.00	3/16	152T-35-SP	152A-35-SP	152N-35-SP

NOTE: 2.5 series inserts fit into both 2 and 2.5 series holders. However, 2 series inserts ONLY fit into 2 series holders. See page A30: 7 for visual.

A30: 112 - 143

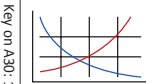

A30: 70 - 74



A30: 4 - 6



Coatings not listed above can be supplied as non-stocked standards. Process fees apply. →

TiN = 152T-XXXX	TiAlN = 152A-XXXX
TiCN = 152N-XXXX	AM200® = 152H-XXXX

Inserts sold in quantities of 2

A DRILLING B BORING C REAMING D BURNISHING E THREADING X SPECIALS

## Original T-A Drill Inserts

2 Series | HSS | Diameter Range: 0.961" - 1.380" (24.41mm - 35.05mm)



Flat Bottom

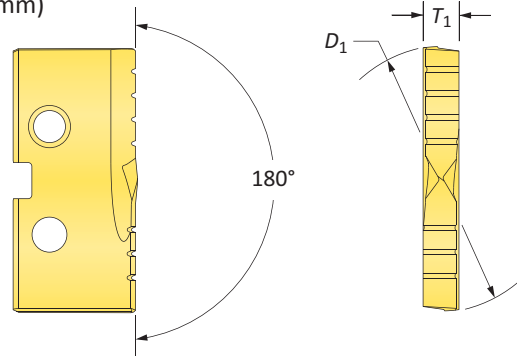

### HSS Inserts – Super Cobalt

Series	Fractional Equivalent	Insert			Flat Bottom Part No.
		$D_1$ inch	$D_1$ mm	$T_1$	TiN 
2	-	0.9646	24.50	3/16	152T-24.5-FB
	31/32	0.9688	24.61	3/16	152T-0031-FB
	-	0.9760	24.79	3/16	152T-.976-FB
	63/64	0.9843	25.00	3/16	152T-25-FB
	1	1.0000	25.40	3/16	152T-0100-FB
	-	1.0039	25.50	3/16	152T-25.5-FB
	1-1/64	1.0156	25.80	3/16	152T-1.015-FB
	-	1.0236	26.00	3/16	152T-26-FB
	1-1/32	1.0313	26.19	3/16	152T-0101-FB
	-	1.0433	26.50	3/16	152T-26.5-FB
	1-3/64	1.0469	26.59	3/16	152T-1.046-FB
	1-1/16	1.0625	26.99	3/16	152T-0102-FB
	-	1.0630	27.00	3/16	152T-27-FB
	-	1.0827	27.50	3/16	152T-27.5-FB
	1-3/32	1.0938	27.78	3/16	152T-0103-FB
	-	1.1024	28.00	3/16	152T-28-FB
	1-7/64	1.1094	28.18	3/16	152T-1.109-FB
	-	1.1220	28.50	3/16	152T-28.5-FB
	1-1/8	1.1250	28.58	3/16	152T-0104-FB
	-	1.1417	29.00	3/16	152T-29-FB
1-5/32	1.1563	29.37	3/16	152T-0105-FB	
-	1.1614	29.50	3/16	152T-29.5-FB	
-	1.1811	30.00	3/16	152T-30-FB	
2.5	1-3/16	1.1875	30.16	3/16	152T-0106-FB
	-	1.2008	30.50	3/16	152T-30.5-FB
	1-7/32	1.2188	30.96	3/16	152T-0107-FB
	-	1.2205	31.00	3/16	152T-31-FB
	-	1.2260	31.14	3/16	152T-1.226-FB
	-	1.2310	31.26	3/16	152T-1.231-FB
	-	1.2340	31.34	3/16	152T-1.234-FB
	-	1.2402	31.50	3/16	152T-31.5-FB
	1-1/4	1.2500	31.75	3/16	152T-0108-FB
	-	1.2598	32.00	3/16	152T-32-FB
	-	1.2795	32.50	3/16	152T-32.5-FB
	1-9/32	1.2813	32.54	3/16	152T-0109-FB
	-	1.2992	33.00	3/16	152T-33-FB
	1-5/16	1.3125	33.34	3/16	152T-0110-FB
	-	1.3189	33.50	3/16	152T-33.5-FB
	-	1.3386	34.00	3/16	152T-34-FB
	1-11/32	1.3438	34.13	3/16	152T-0111-FB
	-	1.3582	34.50	3/16	152T-34.5-FB
	1-3/8	1.3750	34.93	3/16	152T-0112-FB
	-	1.3780	35.00	3/16	152T-35-FB

**NOTE:** 2.5 series inserts fit into both 2 and 2.5 series holders. However, 2 series inserts ONLY fit into 2 series holders. See page A30: 7 for visual.

Inserts sold in quantities of 2

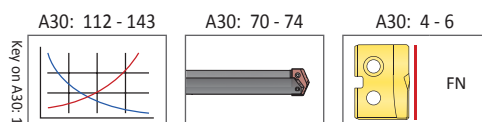

Coatings not listed above can be supplied as non-stocked standards. Process fees apply. →

TiN = 152T-XXXX	TiAlN = 152A-XXXX
TiCN = 152N-XXXX	AM200® = 152H-XXXX



### Original T-A Drill Inserts

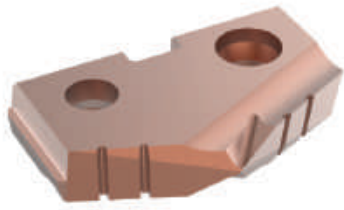

2 Series | HSS | Diameter Range: 0.961" - 1.380" (24.41mm - 35.05mm)

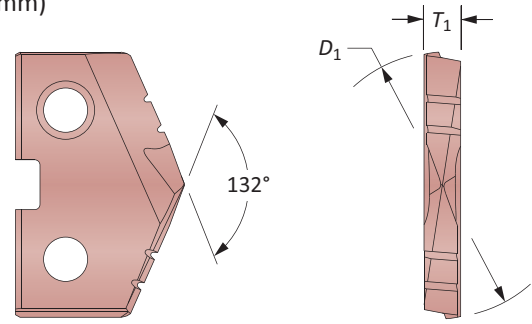

Tube Sheet



HSS Inserts – Super Cobalt | HSS

Series	Fractional Equivalent	Insert			Part No.	
		$D_1$ inch	$D_1$ mm	$T_1$	 Super Cobalt	 HSS
2	–	1.0080	25.60	3/16	<b>152H-1.0080-IN</b>	<b>132H-1.0080-IN</b>
	1-1/64	1.0156	25.80	3/16	<b>152H-1.015-IN</b>	<b>132H-1.015-IN</b>
	1-1/32	1.0313	26.19	3/16	<b>152H-0101-IN</b>	<b>132H-0101-IN</b>

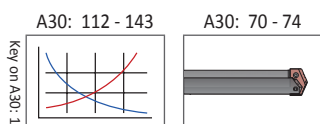

Inserts sold in quantities of 2

Coatings not listed above can be supplied as non-stocked standards. Process fees apply. →



<b>TiN = 152T-XXXX</b>	<b>TiAlN = 152A-XXXX</b>
<b>TiCN = 152N-XXXX</b>	<b>AM200® = 152H-XXXX</b>

## Original T-A Drill Inserts

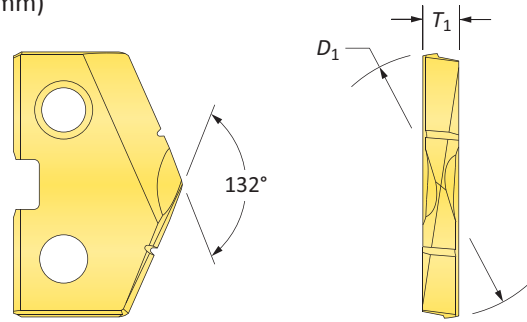

2 Series | HSS | Diameter Range: 0.961" - 1.380" (24.41mm - 35.05mm)



### HSS Inserts – HSS

Series	Insert				Part No.		
	Fractional Equivalent	D <sub>1</sub> inch	D <sub>1</sub> mm	T <sub>1</sub>	 TiN	 TiAlN	 TiCN
2	-	0.9646	24.50	3/16	132T-24.5	132A-24.5	132N-24.5
	31/32	0.9688	24.61	3/16	132T-0031	132A-0031	132N-0031
	-	0.9760	24.79	3/16	132T-.976	132A-.976	132N-.976
	63/64	0.9843	25.00	3/16	132T-25	132A-25	132N-25
	1	1.0000	25.40	3/16	132T-0100	132A-0100	132N-0100
	-	1.0039	25.50	3/16	132T-25.5	132A-25.5	132N-25.5
	1-1/64	1.0156	25.80	3/16	132T-1.015	132A-1.015	132N-1.015
	-	1.0236	26.00	3/16	132T-26	132A-26	132N-26
	1-1/32	1.0313	26.19	3/16	132T-0101	132A-0101	132N-0101
	-	1.0433	26.50	3/16	132T-26.5	132A-26.5	132N-26.5
	1-3/64	1.0469	26.59	3/16	132T-1.046	132A-1.046	132N-1.046
	1-1/16	1.0625	26.99	3/16	132T-0102	132A-0102	132N-0102
	-	1.0630	27.00	3/16	132T-27	132A-27	132N-27
	-	1.0827	27.50	3/16	132T-27.5	132A-27.5	132N-27.5
	1-3/32	1.0938	27.78	3/16	132T-0103	132A-0103	132N-0103
	-	1.1024	28.00	3/16	132T-28	132A-28	132N-28
	1-7/64	1.1094	28.18	3/16	132T-1.109	132A-1.109	132N-1.109
	-	1.1220	28.50	3/16	132T-28.5	132A-28.5	132N-28.5
	1-1/8	1.1250	28.58	3/16	132T-0104	132A-0104	132N-0104
	-	1.1417	29.00	3/16	132T-29	132A-29	132N-29
1-5/32	1.1563	29.37	3/16	132T-0105	132A-0105	132N-0105	
-	1.1614	29.50	3/16	132T-29.5	132A-29.5	132N-29.5	
-	1.1811	30.00	3/16	132T-30	132A-30	132N-30	
2.5	1-3/16	1.1875	30.16	3/16	132T-0106	132A-0106	132N-0106
	-	1.2008	30.50	3/16	132T-30.5	132A-30.5	132N-30.5
	1-7/32	1.2188	30.96	3/16	132T-0107	132A-0107	132N-0107
	-	1.2205	31.00	3/16	132T-31	132A-31	132N-31
	-	1.2260	31.14	3/16	132T-1.226	132A-1.226	132N-1.226
	-	1.2310	31.26	3/16	132T-1.231	132A-1.231	132N-1.231
	-	1.2340	31.34	3/16	132T-1.234	132A-1.234	132N-1.234
	-	1.2402	31.50	3/16	132T-31.5	132A-31.5	132N-31.5
	1-1/4	1.2500	31.75	3/16	132T-0108	132A-0108	132N-0108
	-	1.2598	32.00	3/16	132T-32	132A-32	132N-32
	-	1.2795	32.50	3/16	132T-32.5	132A-32.5	132N-32.5
	1-9/32	1.2813	32.54	3/16	132T-0109	132A-0109	132N-0109
	-	1.2992	33.00	3/16	132T-33	132A-33	132N-33
	1-5/16	1.3125	33.34	3/16	132T-0110	132A-0110	132N-0110
	-	1.3189	33.50	3/16	132T-33.5	132A-33.5	132N-33.5
	-	1.3386	34.00	3/16	132T-34	132A-34	132N-34
	1-11/32	1.3438	34.13	3/16	132T-0111	132A-0111	132N-0111
	-	1.3582	34.50	3/16	132T-34.5	132A-34.5	132N-34.5
	1-3/8	1.3750	34.93	3/16	132T-0112	132A-0112	132N-0112
	-	1.3780	35.00	3/16	132T-35	132A-35	132N-35

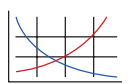
**NOTE:** 2.5 series inserts fit into both 2 and 2.5 series holders. However, 2 series inserts ONLY fit into 2 series holders. See page A30: 7 for visual.

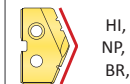
A30: 112 - 143  A30: 70 - 74  A30: 4 - 6 

Key on A30: 1

HI, HR, CR, TC, SK, NP, IN, RN, CN, AN, BR, CI, CP, NC, WC

Coatings not listed above can be supplied as non-stocked standards. Process fees apply. →

TiN = 132T-XXXX	TiAlN = 132A-XXXX
TiCN = 132N-XXXX	AM200® = 132H-XXXX

Inserts sold in quantities of 2



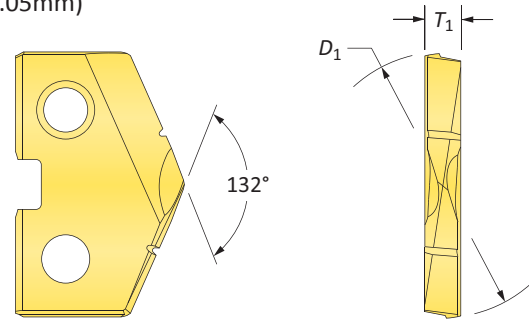

Original T-A Drill Inserts

2 Series | Carbide | Diameter Range: 0.961" - 1.380" (24.41mm - 35.05mm)



Carbide Inserts – C2 (K20)

Series	Fractional Equivalent	Insert			Part No.	
		D <sub>1</sub> inch	D <sub>1</sub> mm	T <sub>1</sub>	 TiN	 TiAlN
2	-	0.9646	24.50	3/16	1C22T-24.5	1C22A-24.5
	31/32	0.9688	24.61	3/16	1C22T-0031	1C22A-0031
	-	0.9760	24.79	3/16	1C22T-.976	1C22A-.976
	63/64	0.9843	25.00	3/16	1C22T-25	1C22A-25
	1	1.0000	25.40	3/16	1C22T-0100	1C22A-0100
	-	1.0039	25.50	3/16	1C22T-25.5	1C22A-25.5
	1-1/64	1.0156	25.80	3/16	1C22T-1.015	1C22A-1.015
	-	1.0236	26.00	3/16	1C22T-26	1C22A-26
	1-1/32	1.0313	26.19	3/16	1C22T-0101	1C22A-0101
	-	1.0433	26.50	3/16	1C22T-26.5	1C22A-26.5
	1-3/64	1.0469	26.59	3/16	1C22T-1.046	1C22A-1.046
	1-1/16	1.0625	26.99	3/16	1C22T-0102	1C22A-0102
	-	1.0630	27.00	3/16	1C22T-27	1C22A-27
	-	1.0827	27.50	3/16	1C22T-27.5	1C22A-27.5
	1-3/32	1.0938	27.78	3/16	1C22T-0103	1C22A-0103
	-	1.1024	28.00	3/16	1C22T-28	1C22A-28
	1-7/64	1.1094	28.18	3/16	1C22T-1.109	1C22A-1.109
	-	1.1220	28.50	3/16	1C22T-28.5	1C22A-28.5
	1-1/8	1.1250	28.58	3/16	1C22T-0104	1C22A-0104
	-	1.1417	29.00	3/16	1C22T-29	1C22A-29
1-5/32	1.1563	29.37	3/16	1C22T-0105	1C22A-0105	
-	1.1614	29.50	3/16	1C22T-29.5	1C22A-29.5	
-	1.1811	30.00	3/16	1C22T-30	1C22A-30	
2.5	1-3/16	1.1875	30.16	3/16	1C22T-0106	1C22A-0106
	-	1.2008	30.50	3/16	1C22T-30.5	1C22A-30.5
	1-7/32	1.2188	30.96	3/16	1C22T-0107	1C22A-0107
	-	1.2205	31.00	3/16	1C22T-31	1C22A-31
	-	1.2260	31.14	3/16	1C22T-1.226	1C22A-1.226
	-	1.2310	31.26	3/16	1C22T-1.231	1C22A-1.231
	-	1.2340	31.34	3/16	1C22T-1.234	1C22A-1.234
	-	1.2402	31.50	3/16	1C22T-31.5	1C22A-31.5
	1-1/4	1.2500	31.75	3/16	1C22T-0108	1C22A-0108
	-	1.2598	32.00	3/16	1C22T-32	1C22A-32
	-	1.2795	32.50	3/16	1C22T-32.5	1C22A-32.5
	1-9/32	1.2813	32.54	3/16	1C22T-0109	1C22A-0109
	-	1.2992	33.00	3/16	1C22T-33	1C22A-33
	1-5/16	1.3125	33.34	3/16	1C22T-0110	1C22A-0110
	-	1.3189	33.50	3/16	1C22T-33.5	1C22A-33.5
	-	1.3386	34.00	3/16	1C22T-34	1C22A-34
	1-11/32	1.3438	34.13	3/16	1C22T-0111	1C22A-0111
	-	1.3582	34.50	3/16	1C22T-34.5	1C22A-34.5
	1-3/8	1.3750	34.93	3/16	1C22T-0112	1C22A-0112
	-	1.3780	35.00	3/16	1C22T-35	1C22A-35

NOTE: 2.5 series inserts fit into both 2 and 2.5 series holders. However, 2 series inserts ONLY fit into 2 series holders. See page A30: 7 for visual.

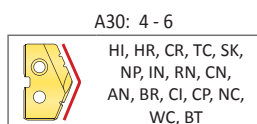
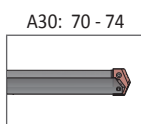
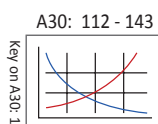

Coatings not listed above can be supplied as non-stocked standards. Process fees apply. →

TiN = 1C22T-XXXX	TiAlN = 1C22A-XXXX
TiCN = 1C22N-XXXX	AM200® = 1C22H-XXXX

Inserts sold in quantities of 1

A  
DRILLING  
B  
BORING  
C  
REAMING  
D  
BURNISHING  
E  
THREADING  
X  
SPECIALS

## Original T-A Drill Inserts

2 Series | Carbide | Diameter Range: 0.961" - 1.380" (24.41mm - 35.05mm)



Flat Bottom

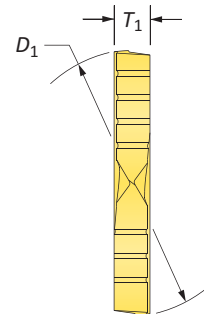
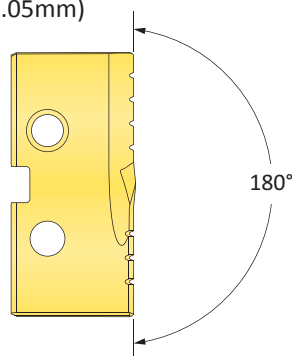

### Carbide Inserts – C2 (K20)

Series	Fractional Equivalent	Insert			Flat Bottom Part No.
		$D_1$ inch	$D_1$ mm	$T_1$	TiN
2	-	0.9646	24.50	3/16	1C22T-24.5-FB
	31/32	0.9688	24.61	3/16	1C22T-0031-FB
	-	0.9760	24.79	3/16	1C22T-.976-FB
	63/64	0.9843	25.00	3/16	1C22T-25-FB
	1	1.0000	25.40	3/16	1C22T-0100-FB
	-	1.0039	25.50	3/16	1C22T-25.5-FB
	1-1/64	1.0156	25.80	3/16	1C22T-1.015-FB
	-	1.0236	26.00	3/16	1C22T-26-FB
	1-1/32	1.0313	26.19	3/16	1C22T-0101-FB
	-	1.0433	26.50	3/16	1C22T-26.5-FB
	1-3/64	1.0469	26.59	3/16	1C22T-1.046-FB
	1-1/16	1.0625	26.99	3/16	1C22T-0102-FB
	-	1.0630	27.00	3/16	1C22T-27-FB
	-	1.0827	27.50	3/16	1C22T-27.5-FB
	1-3/32	1.0938	27.78	3/16	1C22T-0103-FB
	-	1.1024	28.00	3/16	1C22T-28-FB
	1-7/64	1.1094	28.18	3/16	1C22T-1.109-FB
	-	1.1220	28.50	3/16	1C22T-28.5-FB
	1-1/8	1.1250	28.58	3/16	1C22T-0104-FB
	-	1.1417	29.00	3/16	1C22T-29-FB
1-5/32	1.1563	29.37	3/16	1C22T-0105-FB	
-	1.1614	29.50	3/16	1C22T-29.5-FB	
-	1.1811	30.00	3/16	1C22T-30-FB	
1-3/16	1.1875	30.16	3/16	1C22T-0106-FB	
-	1.2008	30.50	3/16	1C22T-30.5-FB	
1-7/32	1.2188	30.96	3/16	1C22T-0107-FB	
-	1.2205	31.00	3/16	1C22T-31-FB	
-	1.2260	31.14	3/16	1C22T-1.226-FB	
-	1.2310	31.26	3/16	1C22T-1.231-FB	
-	1.2340	31.34	3/16	1C22T-1.234-FB	
-	1.2402	31.50	3/16	1C22T-31.5-FB	
1-1/4	1.2500	31.75	3/16	1C22T-0108-FB	
-	1.2598	32.00	3/16	1C22T-32-FB	
-	1.2795	32.50	3/16	1C22T-32.5-FB	
1-9/32	1.2813	32.54	3/16	1C22T-0109-FB	
-	1.2992	33.00	3/16	1C22T-33-FB	
1-5/16	1.3125	33.34	3/16	1C22T-0110-FB	
-	1.3189	33.50	3/16	1C22T-33.5-FB	
-	1.3386	34.00	3/16	1C22T-34-FB	
1-11/32	1.3438	34.13	3/16	1C22T-0111-FB	
-	1.3582	34.50	3/16	1C22T-34.5-FB	
1-3/8	1.3750	34.93	3/16	1C22T-0112-FB	
-	1.3780	35.00	3/16	1C22T-35-FB	

**NOTE:** 2.5 series inserts fit into both 2 and 2.5 series holders. However, 2 series inserts ONLY fit into 2 series holders. See page A30: 7 for visual.

Inserts sold in quantities of 1

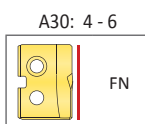
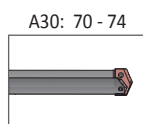
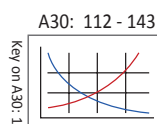

Coatings not listed above can be supplied as non-stocked standards. Process fees apply. →

TiN = 1C22T-XXXX	TiAlN = 1C22A-XXXX
TiCN = 1C22N-XXXX	AM200® = 1C22H-XXXX

Original T-A Drill Inserts

2 Series | Carbide | Diameter Range: 0.961" - 1.380" (24.41mm - 35.05mm)

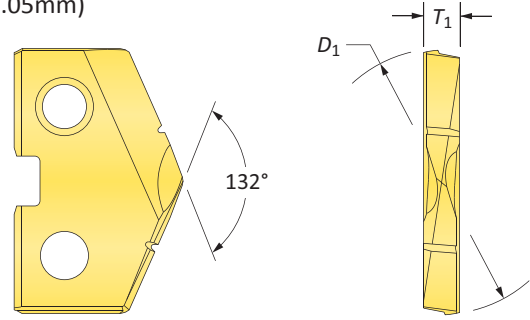
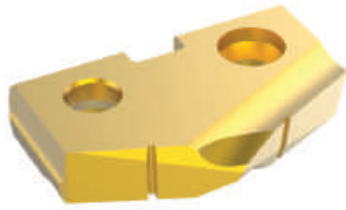

Carbide Inserts – C5 (P40) | C3 (K10) | N2

Series	Insert				C5 Part No.		C3 Part No.	N2 Part No.
	Fractional Equivalent	D <sub>1</sub> inch	D <sub>1</sub> mm	T <sub>1</sub>	TIN	TiAlN	TiAlN (Cast Iron)	Diamond Film*
2	-	0.9646	24.50	3/16	1C52T-24.5	1C52A-24.5	1C32A-24.5-CI	1N22D-24.5
	31/32	0.9688	24.61	3/16	1C52T-0031	1C52A-0031	1C32A-0031-CI	1N22D-0031
	-	0.9760	24.79	3/16	1C52T-.976	1C52A-.976	1C32A-.976-CI	1N22D-.976
	63/64	0.9843	25.00	3/16	1C52T-25	1C52A-25	1C32A-25-CI	1N22D-25
	1	1.0000	25.40	3/16	1C52T-0100	1C52A-0100	1C32A-0100-CI	1N22D-0100
	-	1.0039	25.50	3/16	1C52T-25.5	1C52A-25.5	1C32A-25.5-CI	1N22D-25.5
	1-1/64	1.0156	25.80	3/16	1C52T-1.015	1C52A-1.015	1C32A-1.015-CI	1N22D-1.015
	-	1.0236	26.00	3/16	1C52T-26	1C52A-26	1C32A-26-CI	1N22D-26
	1-1/32	1.0313	26.19	3/16	1C52T-0101	1C52A-0101	1C32A-0101-CI	1N22D-0101
	-	1.0433	26.50	3/16	1C52T-26.5	1C52A-26.5	1C32A-26.5-CI	1N22D-26.5
	1-3/64	1.0469	26.59	3/16	1C52T-1.046	1C52A-1.046	1C32A-1.046-CI	1N22D-1.046
	1-1/16	1.0625	26.99	3/16	1C52T-0102	1C52A-0102	1C32A-0102-CI	1N22D-0102
	-	1.0630	27.00	3/16	1C52T-27	1C52A-27	1C32A-27-CI	1N22D-27
	-	1.0827	27.50	3/16	1C52T-27.5	1C52A-27.5	1C32A-27.5-CI	1N22D-27.5
	1-3/32	1.0938	27.78	3/16	1C52T-0103	1C52A-0103	1C32A-0103-CI	1N22D-0103
	-	1.1024	28.00	3/16	1C52T-28	1C52A-28	1C32A-28-CI	1N22D-28
	1-7/64	1.1094	28.18	3/16	1C52T-1.109	1C52A-1.109	1C32A-1.109-CI	1N22D-1.109
	-	1.1220	28.50	3/16	1C52T-28.5	1C52A-28.5	1C32A-28.5-CI	1N22D-28.5
	1-1/8	1.1250	28.58	3/16	1C52T-0104	1C52A-0104	1C32A-0104-CI	1N22D-0104
	-	1.1417	29.00	3/16	1C52T-29	1C52A-29	1C32A-29-CI	1N22D-29
1-5/32	1.1563	29.37	3/16	1C52T-0105	1C52A-0105	1C32A-0105-CI	1N22D-0105	
-	1.1614	29.50	3/16	1C52T-29.5	1C52A-29.5	1C32A-29.5-CI	1N22D-29.5	
-	1.1811	30.00	3/16	1C52T-30	1C52A-30	1C32A-30-CI	1N22D-30	
1-3/16	1.1875	30.16	3/16	1C52T-0106	1C52A-0106	1C32A-0106-CI	1N22D-0106	
-	1.2008	30.50	3/16	1C52T-30.5	1C52A-30.5	1C32A-30.5-CI	1N22D-30.5	
1-7/32	1.2188	30.96	3/16	1C52T-0107	1C52A-0107	1C32A-0107-CI	1N22D-0107	
-	1.2205	31.00	3/16	1C52T-31	1C52A-31	1C32A-31-CI	1N22D-31	
-	1.2260	31.14	3/16	1C52T-1.226	1C52A-1.226	1C32A-1.226-CI	1N22D-1.226	
-	1.2310	31.26	3/16	1C52T-1.231	1C52A-1.231	1C32A-1.231-CI	1N22D-1.231	
-	1.2340	31.34	3/16	1C52T-1.234	1C52A-1.234	1C32A-1.234-CI	1N22D-1.234	
-	1.2402	31.50	3/16	1C52T-31.5	1C52A-31.5	1C32A-31.5-CI	1N22D-31.5	
1-1/4	1.2500	31.75	3/16	1C52T-0108	1C52A-0108	1C32A-0108-CI	1N22D-0108	
-	1.2598	32.00	3/16	1C52T-32	1C52A-32	1C32A-32-CI	1N22D-32	
-	1.2795	32.50	3/16	1C52T-32.5	1C52A-32.5	1C32A-32.5-CI	1N22D-32.5	
1-9/32	1.2813	32.54	3/16	1C52T-0109	1C52A-0109	1C32A-0109-CI	1N22D-0109	
-	1.2992	33.00	3/16	1C52T-33	1C52A-33	1C32A-33-CI	1N22D-33	
1-5/16	1.3125	33.34	3/16	1C52T-0110	1C52A-0110	1C32A-0110-CI	1N22D-0110	
-	1.3189	33.50	3/16	1C52T-33.5	1C52A-33.5	1C32A-33.5-CI	1N22D-33.5	
-	1.3386	34.00	3/16	1C52T-34	1C52A-34	1C32A-34-CI	1N22D-34	
1-11/32	1.3438	34.13	3/16	1C52T-0111	1C52A-0111	1C32A-0111-CI	1N22D-0111	
-	1.3582	34.50	3/16	1C52T-34.5	1C52A-34.5	1C32A-34.5-CI	1N22D-34.5	
1-3/8	1.3750	34.93	3/16	1C52T-0112	1C52A-0112	1C32A-0112-CI	1N22D-0112	
-	1.3780	35.00	3/16	1C52T-35	1C52A-35	1C32A-35-CI	1N22D-35	

NOTE: 2.5 series inserts fit into both 2 and 2.5 series holders. However, 2 series inserts ONLY fit into 2 series holders. See page A30: 7 for visual.

\*Diamond Film is only available in standard geometry. For additional geometries, please contact Application Engineering.

Inserts sold in quantities of 1

A30: 112 - 143 A30: 70 - 74 A30: 4 - 6 HI, HR, CR, TC, SK, NP, IN, RN, CN, AN, BR, CI, CP, NC, WC, BT

Coatings not listed above can be supplied as non-stocked standards. Process fees apply. →

TiN = 1C52T-XXXX	TiAlN = 1C52A-XXXX
TiCN = 1C52N-XXXX	AM200® = 1C52H-XXXX

A DRILLING  
B BORING  
C REAMING  
D BURNISHING  
E THREADING  
X SPECIALS

## T-A Drill Insert Holders

2 Series | Flange Shank | Diameter Range: 0.961" - 1.380" (24.41mm - 35.05mm)

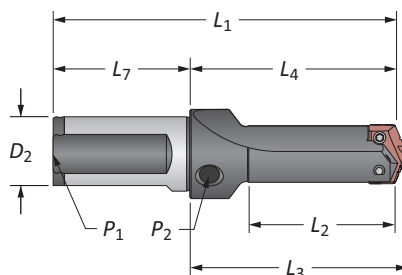
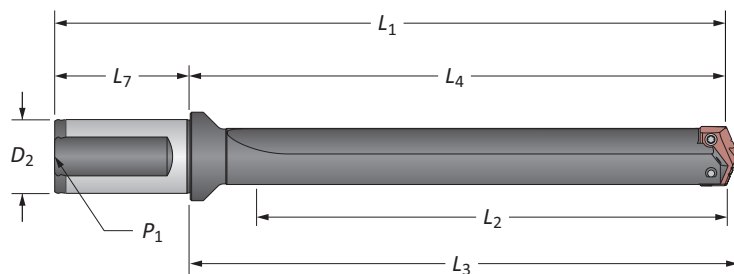

Stub Length

### Straight Flute

Series	Length	Body				Shank			Part No.	
		L <sub>2</sub>	L <sub>4</sub>	L <sub>3</sub>	L <sub>1</sub>	D <sub>2</sub>	L <sub>7</sub>	P <sub>1</sub>		
2	Stub	2-1/4	3-31/64	3-5/8	5-49/64	1-1/4	2-9/32	1/4	21020S-125F	
	Short	3-5/8	5-1/16	5-13/64	7-11/32	1-1/4	2-9/32	1/4	22020S-125F	
	Intermediate	5-3/8	7-1/16	7-13/64	9-11/32	1-1/4	2-9/32	1/4	23020S-125F	
	Standard	7-3/8	9-1/16	9-13/64	11-11/32	1-1/4	2-9/32	1/4	24020S-125F	
	Extended	11-3/8	13-1-16	13-13/64	15-11/32	1-1/4	2-9/32	1/4	<b>25020S-125F</b>	
2.5	Stub	3-5/8	4-55/64	5	7-9/64	1-1/4	2-9/32	1/4	21025S-125F	
	Short	3-5/8	5-1/16	5-13/64	7-11/32	1-1/4	2-9/32	1/4	22025S-125F	
	Intermediate	5-3/8	7-1/16	7-13/64	9-11/32	1-1/4	2-9/32	1/4	23025S-125F	
	Standard	7-3/8	9-1/16	9-13/64	11-11/32	1-1/4	2-9/32	1/4	24025S-125F	
	Extended	11-3/8	13-1-16	13-13/64	15-11/32	1-1/4	2-9/32	1/4	<b>25025S-125F</b>	
m	2	Stub	57.2	88.5	92.1	148.5	32.0	60.0	1/4*	21020S-32FM
		Short	85.7	128.6	132.2	188.6	32.0	60.0	1/4*	22020S-32FM
		XL	511.0	554.1	557.7	614.1	32.0	60.0	1/4*	<b>27020S-32FM</b>
		3XL	692.0	735.1	738.7	795.1	32.0	60.0	1/4*	<b>29020S-32FM</b>
	2.5	Stub	92.1	123.4	127.0	183.4	32.0	60.0	1/4*	21025S-32FM
		Short	85.7	128.6	132.2	188.6	32.0	60.0	1/4*	22025S-32FM

\*Metric thread to BSP and ISO 7-1

**NOTE:** Stub length holders have a 1/8" side pipe tap (P<sub>2</sub>)

### Connection Accessories

Insert Screws	Nylon Locking Screws	Insert Driver	Preset Torque Hand Driver	Replacement Tips	Admissible Tightening Torque*
7495-IP15-1	7495N-IP15-1	8IP-15	8IP-15TL	8IP-15B	61.0 in-lbs (690 N-cm)

\*Tightening torques are calculated with a friction coefficient of  $\mu = 0.14$  and develop 90% of ultimate yield strength

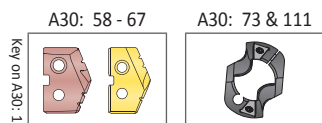

Key on A30: 1

**i** = Imperial (in)

**m** = Metric (mm)

Screws sold in quantities of 10

**WARNING** Refer to Speed and Feed charts for recommended adjustments to speeds and feeds. Refer to page A30: 146 for deep hole drilling guidelines in this section of the catalog. Visit [www.alliedmachine.com/DeepHoleGuidelines](http://www.alliedmachine.com/DeepHoleGuidelines) for the most up-to-date information and procedures. Factory technical assistance is available for your specific applications through our Application Engineering Team.



## T-A Drill Insert Holders

2 Series | Flange Shank | Diameter Range: 0.961" - 1.380" (24.41mm - 35.05mm)

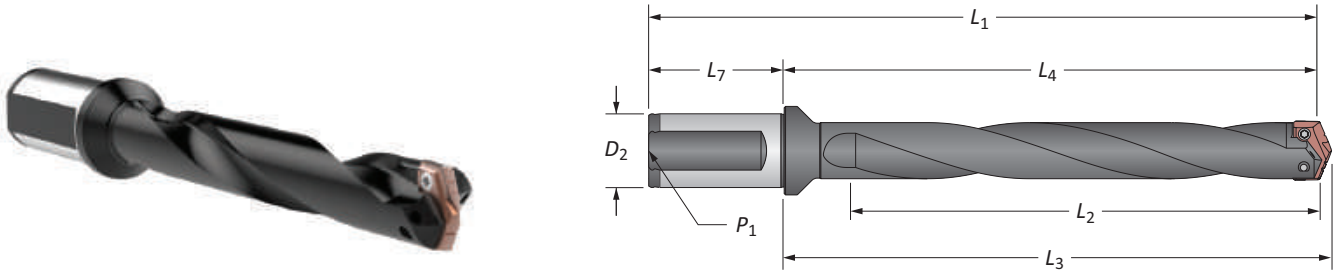





### Helical Flute

Series	Length	Body				Shank			Part No.	
		L <sub>2</sub>	L <sub>4</sub>	L <sub>3</sub>	L <sub>1</sub>	D <sub>2</sub>	L <sub>7</sub>	P <sub>1</sub>		
i	2	Intermediate	5-3/8	7-1/16	7-13/64	9-11/32	1-1/4	2-9/32	1/4	23020H-125F
		Standard	7-3/8	9-1/16	9-13/64	11-11/32	1-1/4	2-9/32	1/4	24020H-125F
		Standard Plus	9-3/8	11-1/16	11-13/64	13-31/64	1-1/4	2-9/32	1/4	24520H-125F
		Extended	11-3/8	13-1/16	13-13/64	15-11/32	1-1/4	2-9/32	1/4	⚠ 25020H-125F
		Long	16-1/8	17-53/64	7-31/32	20-1/4	1-1/4	2-9/32	1/4	⚠ 26020H-125F
2.5	Intermediate	5-3/8	7-1/16	7-13/64	9-11/32	1-1/4	2-9/32	1/4	23025H-125F	
		Standard	7-3/8	9-1/16	9-13/64	11-11/32	1-1/4	2-9/32	1/4	24025H-125F
		Extended	11-3/8	13-1/16	13-13/64	15-11/32	1-1/4	2-9/32	1/4	⚠ 25025H-125F
ii	2	Intermediate	136.5	179.4	183.0	239.4	32.0	60.0	1/4*	23020H-32FM
		Standard	187.3	230.2	233.8	290.2	32.0	60.0	1/4*	24020H-32FM
		Standard Plus	238.0	280.9	284.5	340.9	32.0	60.0	1/4*	24520H-32FM
		Extended	288.9	331.8	335.4	391.8	32.0	60.0	1/4*	⚠ 25020H-32FM
		Long	410.0	452.9	456.5	512.9	32.0	60.0	1/4*	⚠ 26020H-32FM
	2.5	Intermediate	136.5	179.4	183.0	239.4	32.0	60.0	1/4*	23025H-32FM
		Standard	187.3	230.2	233.8	290.2	32.0	60.0	1/4*	24025H-32FM
	Extended	288.9	331.8	335.4	391.8	32.0	60.0	1/4*	⚠ 25025H-32FM	

\*Metric thread to BSP and ISO 7-1

### Connection Accessories

					Admissible Tightening Torque*
7495-IP15-1	7495N-IP15-1	8IP-15	8IP-15TL	8IP-15B	61.0 in-lbs (690 N-cm)

\*Tightening torques are calculated with a friction coefficient of  $\mu = 0.14$  and develop 90% of ultimate yield strength

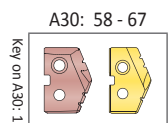

i = Imperial (in)  
m = Metric (mm)

Screws sold in quantities of 10

**⚠ WARNING** Refer to Speed and Feed charts for recommended adjustments to speeds and feeds. Refer to page A30: 146 for deep hole drilling guidelines in this section of the catalog. Visit [www.alliedmachine.com/DeepHoleGuidelines](http://www.alliedmachine.com/DeepHoleGuidelines) for the most up-to-date information and procedures. Factory technical assistance is available for your specific applications through our Application Engineering Team.

## T-A Drill Insert Holders

2 Series | Taper Shank | Diameter Range: 0.961" - 1.380" (24.41mm - 35.05mm)

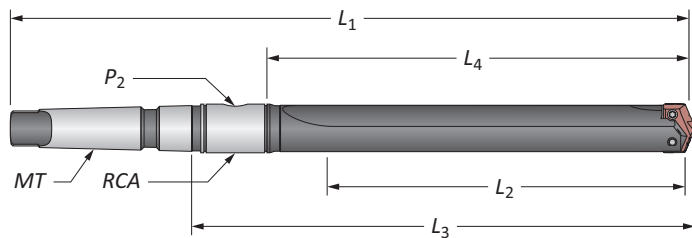

### Straight Flute

Series	Length	Body				Shank			Part No.
		L <sub>2</sub>	L <sub>4</sub>	L <sub>3</sub>	L <sub>1</sub>	MT	P <sub>2</sub>	RCA	
2	Short	3-3/8	4-1/2	6-15/64	9-25/32	#3	1/8	2T-3SR	22020S-003I
	Short	3-3/8	4-1/2	6-19/64	10-25/32	#4	1/8	2T-3SR	22020S-004I
	Intermediate	5-3/8	6-1/2	8-19/64	12-25/32	#4	1/8	2T-3SR	23020S-004I
	Standard	7-3/8	8-1/2	10-15/64	13-25/32	#3	1/8	2T-3SR	24020S-003I
	Standard	7-3/8	8-1/2	10-19/64	14-25/32	#4	1/8	2T-3SR	24020S-004I
2.5	Extended	11-3/8	12-1/2	14-15/64	18-25/32	#4	1/4	2T-3SR	25020S-004I
	Short	3-3/8	4-1/2	6-15/64	9-25/32	#3	1/8	2T-3SR	22025S-003I
	Short	3-3/8	4-1/2	6-37/64	11-1/16	#4	1/4	2T-4SR	22025S-004I
	Intermediate	5-3/8	6-1/2	8-37/64	13-1/16	#4	1/4	2T-4SR	23025S-004I
	Standard	7-3/8	8-1/2	10-15/64	13-25/32	#3	1/8	2T-3SR	24025S-003I
	Standard	7-3/8	8-1/2	10-37/64	15-1/16	#4	1/8	2T-4SR	24025S-004I
2	Short	69.8	98.4	142.5	232.5	#4**	1/8*	2T-3SRM	22020S-004M
	2.5	Short	69.8	98.4	142.5	#4**	1/8*	2T-4SRM	22025S-004M

\*Metric thread to BSP and ISO 7-1

\*\*Per ISO 296 type BEK

**NOTE:** 2.5 series inserts fit into both 2 and 2.5 series holders. However, 2 series inserts ONLY fit into 2 series holders. See page A30: 7 for visual.

### Connection Accessories

Insert Screws	Nylon Locking Screws	Insert Driver	Preset Torque Hand Driver	Replacement Tips	Admissible Tightening Torque*
7495-IP15-1	7495N-IP15-1	8IP-15	8IP-15TL	8IP-15B	61.0 in-lbs (690 N-cm)

\*Tightening torques are calculated with a friction coefficient of  $\mu = 0.14$  and develop 90% of ultimate yield strength

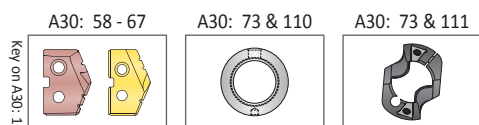

Key on A30: 1

I = Imperial (in)

M = Metric (mm)

Screws sold in quantities of 10

**WARNING** Refer to Speed and Feed charts for recommended adjustments to speeds and feeds. Refer to page A30: 146 for deep hole drilling guidelines in this section of the catalog. Visit [www.alliedmachine.com/DeepHoleGuidelines](http://www.alliedmachine.com/DeepHoleGuidelines) for the most up-to-date information and procedures. Factory technical assistance is available for your specific applications through our Application Engineering Team.

## T-A Drill Insert Holders

2 Series | Taper Shank | Diameter Range: 0.961" - 1.380" (24.41mm - 35.05mm)

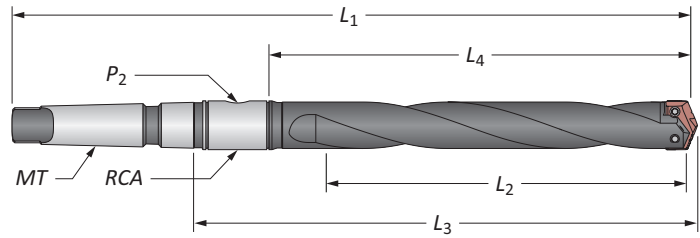

### Helical Flute

Series	Length	Body				Shank			Part No.	
		L <sub>2</sub>	L <sub>4</sub>	L <sub>3</sub>	L <sub>1</sub>	MT	P <sub>2</sub>	RCA		
i	2	Intermediate	5-3/8	6-1/2	8-19/64	12-25/32	#4	1/8	2T-3SR	23020H-004I
		Standard	7-3/8	8-1/2	10-15/64	13-25/32	#3	1/8	2T-3SR	24020H-003I
		Standard	7-3/8	8-1/2	10-19/64	14-25/32	#4	1/8	2T-3SR	24020H-004I
		Extended	11-3/8	12-1/2	14-15/64	18-25/32	#4	1/8	2T-3SR	⚠ 25020H-004I
	2.5	Intermediate	5-3/8	6-1/2	8-37/64	13-1/16	#4	1/4	2T-4SR	23025H-004I
		Standard	7-3/8	8-1/2	10-15/64	13-25/32	#3	1/8	2T-3SR	24025H-003I
		Standard	7-3/8	8-1/2	10-37/64	15-1/6	#4	1/4	2T-4SR	24025H-004I
		Extended	11-3/8	12-1/2	14-37/64	19-1/16	#4	1/4	2T-4SR	⚠ 25025H-004I
m	2	Intermediate	136.5	165.1	211.2	324.6	#4**	1/8*	2T-3SRM	23020H-004M
		Standard	187.3	215.9	262.0	375.4	#4**	1/8*	2T-3SRM	24020H-004M
		Extended	289.0	317.5	363.6	477.0	#4**	1/8*	2T-3SRM	⚠ 25020H-004M
		Intermediate	136.5	165.1	218.4	331.8	#4**	1/4*	2T-4SRM	23025H-004M
	2.5	Standard	187.3	215.9	269.2	382.6	#4**	1/4*	2T-4SRM	24025H-004M
		Extended	289.0	317.5	370.8	484.2	#4**	1/4*	2T-4SRM	⚠ 25025H-004M

\*Metric thread to BSP and ISO 7-1

\*\*Per ISO 296 type BEK

**NOTE:** 2.5 series inserts fit into both 2 and 2.5 series holders. However, 2 series inserts ONLY fit into 2 series holders. See page A30: 7 for visual.

### Connection Accessories

Insert Screws	Nylon Locking Screws	Insert Driver	Preset Torque Hand Driver	Replacement Tips	Admissible Tightening Torque*
7495-IP15-1	7495N-IP15-1	8IP-15	8IP-15TL	8IP-15B	61.0 in-lbs (690 N-cm)

\*Tightening torques are calculated with a friction coefficient of  $\mu = 0.14$  and develop 90% of ultimate yield strength

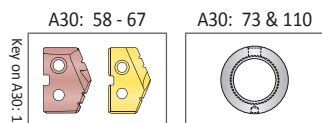

i = Imperial (in)  
m = Metric (mm)

Screws sold in quantities of 10

**⚠ WARNING** Refer to Speed and Feed charts for recommended adjustments to speeds and feeds. Refer to page A30: 146 for deep hole drilling guidelines in this section of the catalog. Visit [www.alliedmachine.com/DeepHoleGuidelines](http://www.alliedmachine.com/DeepHoleGuidelines) for the most up-to-date information and procedures. Factory technical assistance is available for your specific applications through our Application Engineering Team.

## T-A Drill Insert Holders

2 Series | Straight Shank | Diameter Range: 0.961" - 1.380" (24.41mm - 35.05mm)

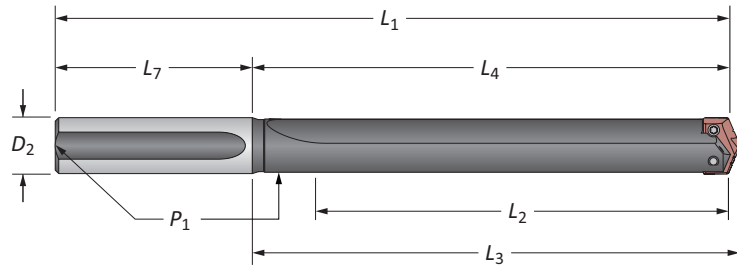





### Straight Flute

Series	Length	Body				Shank			Part No.
		L <sub>2</sub>	L <sub>4</sub>	L <sub>3</sub>	L <sub>1</sub>	D <sub>2</sub>	L <sub>7</sub>	P <sub>1</sub>	
2	Short	3-3/8	4-1/2	4-41/64	8	1	3-1/2	1/8	22020S-100L
	Short	3-3/8	4-1/2	4-41/64	8	1-1/4	3-1/2	1/8	22020S-125L
	Intermediate	5-3/8	6-1/2	6-41/64	10	1-1/4	3-1/2	1/8	23020S-125L
	Standard	7-3/8	8-1/2	8-41/64	12	1	3-1/2	1/8	24020S-100L
	Standard	7-3/8	8-1/2	8-41/64	12	1-1/4	3-1/2	1/8	24020S-125L
	Extended	11-3/8	12-1/2	12-41/64	16	1-1/4	3-1/2	1/8	25020S-125L
	XL	20-1/8	21-1/4	21-25/64	24-3/4	1-1/4	3-1/2	1/8	27020S-125L
2.5	3XL	27-1/4	28-3/8	28-33/64	31-7/8	1-1/4	3-1/2	1/8	29020S-125L
	Short	3-3/8	4-1/2	4-41/64	8	1	3-1/2	1/8*	22025S-100L
	Short	3-3/8	4-1/2	4-41/64	8	1-1/4	3-1/2	1/8*	22025S-125L
	Intermediate	5-3/8	6-1/2	6-41/64	10	1-1/4	3-1/2	1/8*	23025S-125L
	Standard	7-3/8	8-1/2	8-41/64	12	1	3-1/2	1/8*	24025S-100L
	Standard	7-3/8	8-1/2	8-41/64	12	1-1/4	3-1/2	1/8*	24025S-125L
	Extended	11-3/8	12-1/2	12-41/64	16	1-1/4	3-1/2	1/8*	25025S-125L

**NOTE:** 2.5 series inserts fit into both 2 and 2.5 series holders. However, 2 series inserts ONLY fit into 2 series holders. See page A30: 7 for visual.

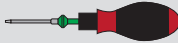
### Connection Accessories

					Admissible Tightening Torque*
7495-IP15-1	7495N-IP15-1	8IP-15	8IP-15TL	8IP-15B	

\*Tightening torques are calculated with a friction coefficient of  $\mu = 0.14$  and develop 90% of ultimate yield strength

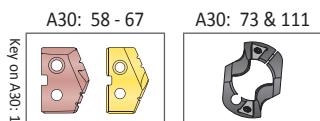

i = Imperial (in)  
m = Metric (mm)

Screws sold in quantities of 10

**WARNING** Refer to Speed and Feed charts for recommended adjustments to speeds and feeds. Refer to page A30: 146 for deep hole drilling guidelines in this section of the catalog. Visit [www.alliedmachine.com/DeepHoleGuidelines](http://www.alliedmachine.com/DeepHoleGuidelines) for the most up-to-date information and procedures. Factory technical assistance is available for your specific applications through our Application Engineering Team.

T-A Drill Accessories

2 Series | Chamfer Rings | Rotary Coolant Adapters | Torx® Plus Screws

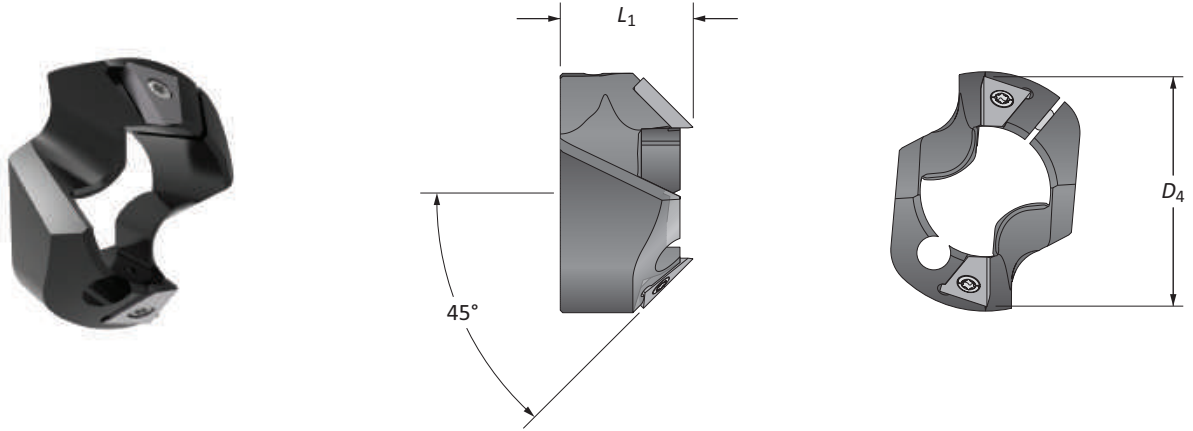

T-ACR 45 Chamfer Ring

Holder Series	D <sub>1</sub> Range	Chamfer Ring		Part No.	Insert Part No.	Insert Screw	Insert Driver	Clamping Screw	Insert Driver
		D <sub>4</sub>	L <sub>1</sub>						
2	0.9610 - 1.3800	1-9/16	1	T-ACR-45-2	T-ACRI-45-B-C5A	7255-IP8-1	8IP-8	7514-IP20-1	8IP-20

Rotary Coolant Adapter (RCA) and Accessories

ID	OD	L <sub>1</sub>	Driving Rod Thread	P <sub>1</sub>	Part No.	RCA O-Rings		
						Kit Part No.**	Replacements	
i	1	2-1/8	1-1/8	5/16-18	1/8	▲ 2T-3SR	2T1-3SR	2T1-3OR-10
	1-1/4	2-1/2	1-3/8	3/8-16	1/4	▲ 2T-4SR	2T1-4SR	2T1-4OR-10
m	25.40	53.97	28.57	M8 x 1.25	1/8*	▲ 2T-3SRM	2T1-3SR	2T1-3OR-10
	31.75	63.50	34.92	M10 x 1.50	1/4*	▲ 2T-4SRM	2T1-4SR	2T1-4OR-10

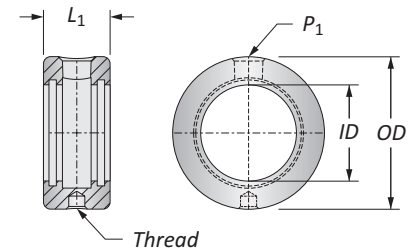

\*Thread to BSP and ISO 7-1

\*\*RCA Repair Kit includes (2) O-rings, (2) snap rings, and (2) thrust washers

▲ Refer to page A30: 110 for proper RCA assembly and safety information

Connection Accessories

Insert Screws	Nylon Locking Screws	Insert Driver	Preset Torque Hand Driver	Replacement Tips	Admissible Tightening Torque*
7495-IP15-1	7495N-IP15-1	8IP-15	8IP-15TL	8IP-15B	61.0 in-lbs (690 N-cm)

\*Tightening torques are calculated with a friction coefficient of  $\mu = 0.14$  and develop 90% of ultimate yield strength

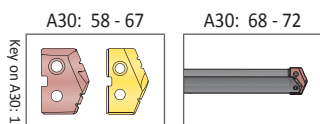

i = Imperial (in)  
 m = Metric (mm)  
 Inserts sold separately  
 Screws sold in packs of 10  
 O-rings sold in packs of 10

**WARNING** RCA rotation during drilling can cause hose and/or hose fitting failure, machinery damage, and/or serious injury. To prevent, use RCA and positive stop studs when drilling. Factory technical assistance is also available for your specific applications.



A DRILLING  
 B BORING  
 C REAMING  
 D BURNISHING  
 E THREADING  
 X SPECIALS

## GEN2 T-A Drill Inserts

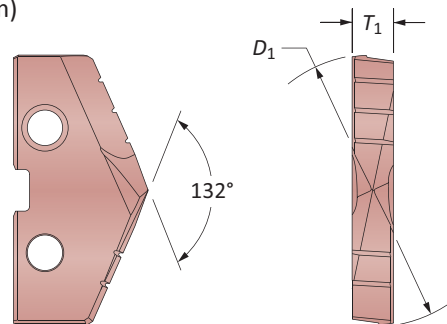
3 Series | HSS | Diameter Range: 1.353" - 1.882" (34.36mm - 47.80mm)

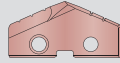

### HSS Inserts – Premium Cobalt

Fractional Equivalent	Insert			Part No.	
	$D_1$ inch	$D_1$ mm	$T_1$	 AM200®	 TiN
1-13/32	1.4063	35.72	1/4	483H-0113	483T-0113
-	1.4173	36.00	1/4	483H-36	483T-36
1-7/16	1.4375	36.51	1/4	483H-0114	483T-0114
-	1.4567	37.00	1/4	483H-37	483T-37
1-15/32	1.4688	37.31	1/4	483H-0115	483T-0115
-	1.4961	38.00	1/4	483H-38	483T-38
1-1/2	1.5000	38.10	1/4	483H-0116	483T-0116
1-17/32	1.5313	38.89	1/4	483H-0117	483T-0117
-	1.5354	39.00	1/4	483H-39	483T-39
-	1.5470	39.29	1/4	483H-1.547	483T-1.547
1-9/16	1.5625	39.69	1/4	483H-0118	483T-0118
-	1.5748	40.00	1/4	483H-40	483T-40
1-19/32	1.5938	40.48	1/4	483H-0119	483T-0119
-	1.6142	41.00	1/4	483H-41	483T-41
1-5/8	1.6250	41.28	1/4	483H-0120	483T-0120
-	1.6535	42.00	1/4	483H-42	483T-42
1-21/32	1.6563	42.07	1/4	483H-0121	483T-0121
1-11/16	1.6875	42.86	1/4	483H-0122	483T-0122
-	1.6929	43.00	1/4	483H-43	483T-43
1-23/32	1.7188	43.66	1/4	483H-0123	483T-0123
-	1.7323	44.00	1/4	483H-44	483T-44
1-3/4	1.7500	44.45	1/4	483H-0124	483T-0124
-	1.7717	45.00	1/4	483H-45	483T-45
1-25/32	1.7813	45.24	1/4	483H-0125	483T-0125
-	1.7913	45.50	1/4	483H-45.5	483T-45.5
-	1.7970	45.64	1/4	483H-1.797	483T-1.797
-	1.8110	46.00	1/4	483H-46	483T-46
1-13/16	1.8125	46.04	1/4	483H-0126	483T-0126
1-27/32	1.8438	46.83	1/4	483H-0127	483T-0127
-	1.8504	47.00	1/4	483H-47	483T-47
1-7/8	1.8750	47.63	1/4	483H-0128	483T-0128

Inserts sold in quantities of 1

A30: 112 - 143

A30: 82 - 85

A30: 4 - 6

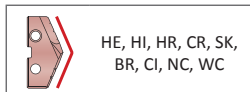
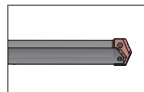
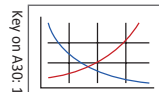

Coatings not listed above can be supplied as non-stocked standards. Process fees apply. →

TiN = 483T-XXXX	TiAlN = 483A-XXXX
TiCN = 483N-XXXX	AM200® = 483H-XXXX

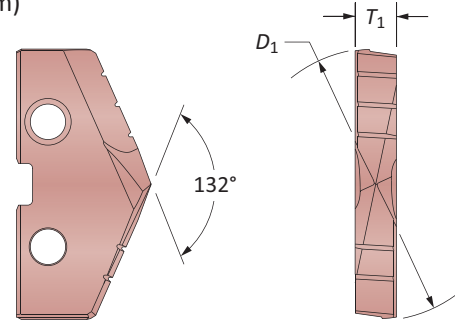

**GEN2 T-A Drill Inserts**

3 Series | HSS | Diameter Range: 1.353" - 1.882" (34.36mm - 47.80mm)

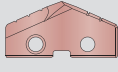
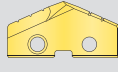

**HSS Inserts – Super Cobalt**

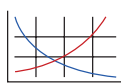
Fractional Equivalent	Insert			Part No.	
	$D_1$ inch	$D_1$ mm	$T_1$	 AM200®	 TiN
1-13/32	1.4063	35.72	1/4	453H-0113	453T-0113
-	1.4173	36.00	1/4	453H-36	453T-36
1-7/16	1.4375	36.51	1/4	453H-0114	453T-0114
-	1.4567	37.00	1/4	453H-37	453T-37
1-15/32	1.4688	37.31	1/4	453H-0115	453T-0115
-	1.4961	38.00	1/4	453H-38	453T-38
1-1/2	1.5000	38.10	1/4	453H-0116	453T-0116
1-17/32	1.5313	38.89	1/4	453H-0117	453T-0117
-	1.5354	39.00	1/4	453H-39	453T-39
-	1.5470	39.29	1/4	453H-1.547	453T-1.547
1-9/16	1.5625	39.69	1/4	453H-0118	453T-0118
-	1.5748	40.00	1/4	453H-40	453T-40
1-19/32	1.5938	40.48	1/4	453H-0119	453T-0119
-	1.6142	41.00	1/4	453H-41	453T-41
1-5/8	1.6250	41.28	1/4	453H-0120	453T-0120
-	1.6535	42.00	1/4	453H-42	453T-42
1-21/32	1.6563	42.07	1/4	453H-0121	453T-0121
1-11/16	1.6875	42.86	1/4	453H-0122	453T-0122
-	1.6929	43.00	1/4	453H-43	453T-43
1-23/32	1.7188	43.66	1/4	453H-0123	453T-0123
-	1.7323	44.00	1/4	453H-44	453T-44
1-3/4	1.7500	44.45	1/4	453H-0124	453T-0124
-	1.7717	45.00	1/4	453H-45	453T-45
1-25/32	1.7813	45.24	1/4	453H-0125	453T-0125
-	1.7913	45.50	1/4	453H-45.5	453T-45.5
-	1.7970	45.64	1/4	453H-1.797	453T-1.797
-	1.8110	46.00	1/4	453H-46	453T-46
1-13/16	1.8125	46.04	1/4	453H-0126	453T-0126
1-27/32	1.8438	46.83	1/4	453H-0127	453T-0127
-	1.8504	47.00	1/4	453H-47	453T-47
1-7/8	1.8750	47.63	1/4	453H-0128	453T-0128

A30: 112 - 143  A30: 82 - 85  A30: 4 - 6  HE, HI, HR, CR, SK, BR, CI, NC, WC

Coatings not listed above can be supplied as non-stocked standards. Process fees apply. 

Inserts sold in quantities of 1

TiN = 453T-XXXX	TiAlN = 453A-XXXX
TiCN = 453N-XXXX	AM200® = 453H-XXXX

## GEN2 T-A Drill Inserts

3 Series | HSS | Diameter Range: 1.353" - 1.882" (34.36mm - 47.80mm)

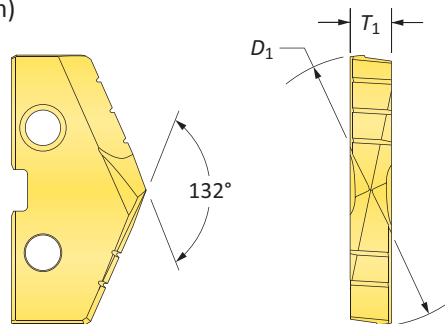

### HSS Inserts – HSS

Fractional Equivalent	Insert			Part No.
	$D_1$ inch	$D_1$ mm	$T_1$	
1-13/32	1.4063	35.72	1/4	 <b>433T-0113</b>
-	1.4173	36.00	1/4	<b>433T-36</b>
1-7/16	1.4375	36.51	1/4	<b>433T-0114</b>
-	1.4567	37.00	1/4	<b>433T-37</b>
1-15/32	1.4688	37.31	1/4	<b>433T-0115</b>
-	1.4961	38.00	1/4	<b>433T-38</b>
1-1/2	1.5000	38.10	1/4	<b>433T-0116</b>
1-17/32	1.5313	38.89	1/4	<b>433T-0117</b>
-	1.5354	39.00	1/4	<b>433T-39</b>
-	1.5470	39.29	1/4	<b>433T-1.547</b>
1-9/16	1.5625	39.69	1/4	<b>433T-0118</b>
-	1.5748	40.00	1/4	<b>433T-40</b>
1-19/32	1.5938	40.48	1/4	<b>433T-0119</b>
-	1.6142	41.00	1/4	<b>433T-41</b>
1-5/8	1.6250	41.28	1/4	<b>433T-0120</b>
-	1.6535	42.00	1/4	<b>433T-42</b>
1-21/32	1.6563	42.07	1/4	<b>433T-0121</b>
1-11/16	1.6875	42.86	1/4	<b>433T-0122</b>
-	1.6929	43.00	1/4	<b>433T-43</b>
1-23/32	1.7188	43.66	1/4	<b>433T-0123</b>
-	1.7323	44.00	1/4	<b>433T-44</b>
1-3/4	1.7500	44.45	1/4	<b>433T-0124</b>
-	1.7717	45.00	1/4	<b>433T-45</b>
1-25/32	1.7813	45.24	1/4	<b>433T-0125</b>
-	1.7913	45.50	1/4	<b>433T-45.5</b>
-	1.7970	45.64	1/4	<b>433T-1.797</b>
-	1.8110	46.00	1/4	<b>433T-46</b>
1-13/16	1.8125	46.04	1/4	<b>433T-0126</b>
1-27/32	1.8438	46.83	1/4	<b>433T-0127</b>
-	1.8504	47.00	1/4	<b>433T-47</b>
1-7/8	1.8750	47.63	1/4	<b>433T-0128</b>

Inserts sold in quantities of 1

A30: 112 - 143

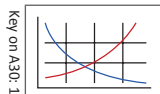

A30: 82 - 85

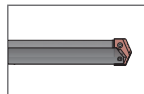

A30: 4 - 6

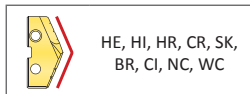

Coatings not listed above  
can be supplied as  
non-stocked standards.  
Process fees apply. →

TiN = 433T-XXXX

TiAlN = 433A-XXXX

TiCN = 433N-XXXX

AM200® = 433H-XXXX



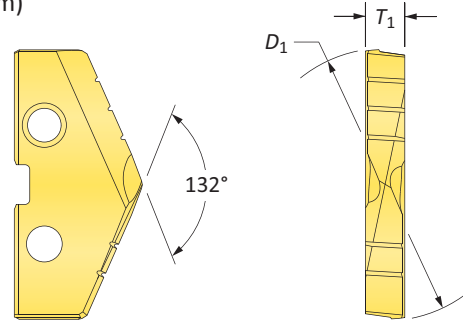

**Original T-A Drill Inserts**

3 Series | HSS | Diameter Range: 1.353" - 1.882" (34.36mm - 47.80mm)

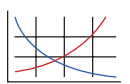

**HSS Inserts – Super Cobalt**

Fractional Equivalent	Insert			Part No.
	D <sub>1</sub> inch	D <sub>1</sub> mm	T <sub>1</sub>	
1-13/32	1.4063	35.72	1/4	153T-0113
-	1.4173	36.00	1/4	153T-36
1-7/16	1.4375	36.51	1/4	153T-0114
-	1.4567	37.00	1/4	153T-37
1-15/32	1.4688	37.31	1/4	153T-0115
-	1.4961	38.00	1/4	153T-38
1-1/2	1.5000	38.10	1/4	153T-0116
1-17/32	1.5313	38.89	1/4	153T-0117
-	1.5354	39.00	1/4	153T-39
-	1.5470	39.29	1/4	153T-1.547
1-9/16	1.5625	39.69	1/4	153T-0118
-	1.5748	40.00	1/4	153T-40
1-19/32	1.5938	40.48	1/4	153T-0119
-	1.6142	41.00	1/4	153T-41
1-5/8	1.6250	41.28	1/4	153T-0120
-	1.6535	42.00	1/4	153T-42
1-21/32	1.6563	42.07	1/4	153T-0121
1-11/16	1.6875	42.86	1/4	153T-0122
-	1.6929	43.00	1/4	153T-43
1-23/32	1.7188	43.66	1/4	153T-0123
-	1.7323	44.00	1/4	153T-44
1-3/4	1.7500	44.45	1/4	153T-0124
-	1.7717	45.00	1/4	153T-45
1-25/32	1.7813	45.24	1/4	153T-0125
-	1.7913	45.50	1/4	153T-45.5
-	1.7970	45.64	1/4	153T-1.797
-	1.8110	46.00	1/4	153T-46
1-13/16	1.8125	46.04	1/4	153T-0126
1-27/32	1.8438	46.83	1/4	153T-0127
-	1.8504	47.00	1/4	153T-47
1-7/8	1.8750	47.63	1/4	153T-0128

A30: 112 - 143  A30: 82 - 85  A30: 4 - 6  HI, HR, CR, SK, BR, CI, NC, WC, TC

Coatings not listed above can be supplied as non-stocked standards. Process fees apply. →

Inserts sold in quantities of 1

TiN = 153T-XXXX	TiAlN = 153A-XXXX
TiCN = 153N-XXXX	AM200® = 153H-XXXX

## Original T-A Drill Inserts

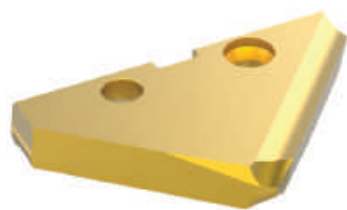

3 Series | HSS | Diameter Range: 1.353" - 1.882" (34.36mm - 47.80mm)

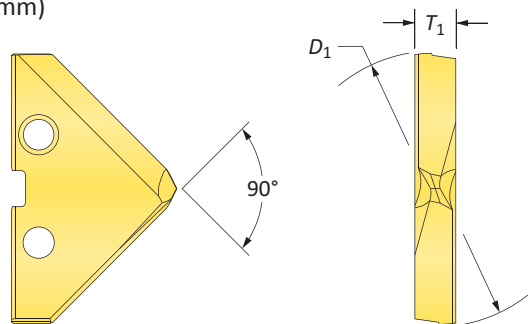

90° Spot & Chamfer



### HSS Inserts – Super Cobalt

Fractional Equivalent	Insert			Part No.		
	$D_1$ inch	$D_1$ mm	$T_1$	 TiN	 TiAlN	 TiCN
1-13/32	1.4063	35.72	1/4	153T-0113-SP	153A-0113-SP	153N-0113-SP
-	1.4173	36.00	1/4	153T-36-SP	153A-36-SP	153N-36-SP
1-7/16	1.4375	36.51	1/4	153T-0114-SP	153A-0114-SP	153N-0114-SP
-	1.4567	37.00	1/4	153T-37-SP	153A-37-SP	153N-37-SP
1-15/32	1.4688	37.31	1/4	153T-0115-SP	153A-0115-SP	153N-0115-SP
-	1.4961	38.00	1/4	153T-38-SP	153A-38-SP	153N-38-SP
1-1/2	1.5000	38.10	1/4	153T-0116-SP	153A-0116-SP	153N-0116-SP
1-17/32	1.5313	38.89	1/4	153T-0117-SP	153A-0117-SP	153N-0117-SP
-	1.5354	39.00	1/4	153T-39-SP	153A-39-SP	153N-39-SP
-	1.5470	39.29	1/4	153T-1.547-SP	153A-1.547-SP	153N-1.547-SP
1-9/16	1.5625	39.69	1/4	153T-0118-SP	153A-0118-SP	153N-0118-SP
-	1.5748	40.00	1/4	153T-40-SP	153A-40-SP	153N-40-SP
1-19/32	1.5938	40.48	1/4	153T-0119-SP	153A-0119-SP	153N-0119-SP
-	1.6142	41.00	1/4	153T-41-SP	153A-41-SP	153N-41-SP
1-5/8	1.6250	41.28	1/4	153T-0120-SP	153A-0120-SP	153N-0120-SP
-	1.6535	42.00	1/4	153T-42-SP	153A-42-SP	153N-42-SP
1-21/32	1.6563	42.07	1/4	153T-0121-SP	153A-0121-SP	153N-0121-SP
1-11/16	1.6875	42.86	1/4	153T-0122-SP	153A-0122-SP	153N-0122-SP
-	1.6929	43.00	1/4	153T-43-SP	153A-43-SP	153N-43-SP
1-23/32	1.7188	43.66	1/4	153T-0123-SP	153A-0123-SP	153N-0123-SP
-	1.7323	44.00	1/4	153T-44-SP	153A-44-SP	153N-44-SP
1-3/4	1.7500	44.45	1/4	153T-0124-SP	153A-0124-SP	153N-0124-SP
-	1.7717	45.00	1/4	153T-45-SP	153A-45-SP	153N-45-SP
1-25/32	1.7813	45.24	1/4	153T-0125-SP	153A-0125-SP	153N-0125-SP
-	1.7913	45.50	1/4	153T-45.5-SP	153A-45.5-SP	153N-45.5-SP
-	1.7970	45.64	1/4	153T-1.797-SP	153A-1.797-SP	153N-1.797-SP
-	1.8110	46.00	1/4	153T-46-SP	153A-46-SP	153N-46-SP
1-13/16	1.8125	46.04	1/4	153T-0126-SP	153A-0126-SP	153N-0126-SP
1-27/32	1.8438	46.83	1/4	153T-0127-SP	153A-0127-SP	153N-0127-SP
-	1.8504	47.00	1/4	153T-47-SP	153A-47-SP	153N-47-SP
1-7/8	1.8750	47.63	1/4	153T-0128-SP	153A-0128-SP	153N-0128-SP

Inserts sold in quantities of 1

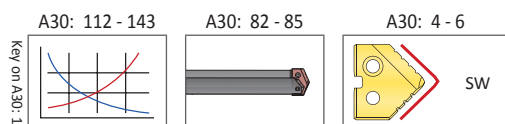

Coatings not listed above can be supplied as non-stocked standards. Process fees apply. →

TiN = 153T-XXXX	TiAlN = 153A-XXXX
TiCN = 153N-XXXX	AM200® = 153H-XXXX

### Original T-A Drill Inserts

3 Series | HSS | Diameter Range: 1.353" - 1.882" (34.36mm - 47.80mm)



Flat Bottom

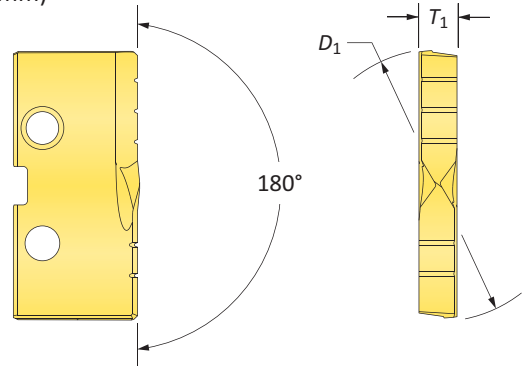

#### HSS Inserts – Super Cobalt

Fractional Equivalent	Insert			Part No.
	D <sub>1</sub> inch	D <sub>1</sub> mm	T <sub>1</sub>	
1-13/32	1.4063	35.72	1/4	153T-0113-FB
-	1.4173	36.00	1/4	153T-36-FB
1-7/16	1.4375	36.51	1/4	153T-0114-FB
-	1.4567	37.00	1/4	153T-37-FB
1-15/32	1.4688	37.31	1/4	153T-0115-FB
-	1.4961	38.00	1/4	153T-38-FB
1-1/2	1.5000	38.10	1/4	153T-0116-FB
1-17/32	1.5313	38.89	1/4	153T-0117-FB
-	1.5354	39.00	1/4	153T-39-FB
-	1.5470	39.29	1/4	153T-1.547-FB
1-9/16	1.5625	39.69	1/4	153T-0118-FB
-	1.5748	40.00	1/4	153T-40-FB
1-19/32	1.5938	40.48	1/4	153T-0119-FB
-	1.6142	41.00	1/4	153T-41-FB
1-5/8	1.6250	41.28	1/4	153T-0120-FB
-	1.6535	42.00	1/4	153T-42-FB
1-21/32	1.6563	42.07	1/4	153T-0121-FB
1-11/16	1.6875	42.86	1/4	153T-0122-FB
-	1.6929	43.00	1/4	153T-43-FB
1-23/32	1.7188	43.66	1/4	153T-0123-FB
-	1.7323	44.00	1/4	153T-44-FB
1-3/4	1.7500	44.45	1/4	153T-0124-FB
-	1.7717	45.00	1/4	153T-45-FB
1-25/32	1.7813	45.24	1/4	153T-0125-FB
-	1.7913	45.50	1/4	153T-45.5-FB
-	1.7970	45.64	1/4	153T-1.797-FB
-	1.8110	46.00	1/4	153T-46-FB
1-13/16	1.8125	46.04	1/4	153T-0126-FB
1-27/32	1.8438	46.83	1/4	153T-0127-FB
-	1.8504	47.00	1/4	153T-47-FB
1-7/8	1.8750	47.63	1/4	153T-0128-FB

Key on A30-1

A30: 112 - 143

A30: 82 - 85

A30: 4 - 6

Coatings not listed above can be supplied as non-stocked standards. Process fees apply. →

TiN = 153T-XXXX	TiAlN = 153A-XXXX
TiCN = 153N-XXXX	AM200® = 153H-XXXX

Inserts sold in quantities of 1

## Original T-A Drill Inserts

3 Series | Carbide | Diameter Range: 1.353" - 1.882" (34.36mm - 47.80mm)

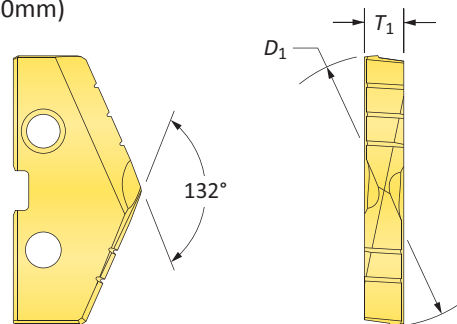

### Carbide Inserts – C2 (K20)

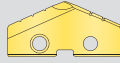
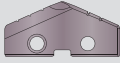
Fractional Equivalent	Insert			Part No.	
	$D_1$ inch	$D_1$ mm	$T_1$	 TiN	 TiAlN
1-13/32	1.4063	35.72	1/4	1C23T-0113	1C23A-0113
-	1.4173	36.00	1/4	1C23T-36	1C23A-36
1-7/16	1.4375	36.51	1/4	1C23T-0114	1C23A-0114
-	1.4567	37.00	1/4	1C23T-37	1C23A-37
1-15/32	1.4688	37.31	1/4	1C23T-0115	1C23A-0115
-	1.4961	38.00	1/4	1C23T-38	1C23A-38
1-1/2	1.5000	38.10	1/4	1C23T-0116	1C23A-0116
1-17/32	1.5313	38.89	1/4	1C23T-0117	1C23A-0117
-	1.5354	39.00	1/4	1C23T-39	1C23A-39
-	1.5470	39.29	1/4	1C23T-1.547	1C23A-1.547
1-9/16	1.5625	39.69	1/4	1C23T-0118	1C23A-0118
-	1.5748	40.00	1/4	1C23T-40	1C23A-40
1-19/32	1.5938	40.48	1/4	1C23T-0119	1C23A-0119
-	1.6142	41.00	1/4	1C23T-41	1C23A-41
1-5/8	1.6250	41.28	1/4	1C23T-0120	1C23A-0120
-	1.6535	42.00	1/4	1C23T-42	1C23A-42
1-21/32	1.6563	42.07	1/4	1C23T-0121	1C23A-0121
1-11/16	1.6875	42.86	1/4	1C23T-0122	1C23A-0122
-	1.6929	43.00	1/4	1C23T-43	1C23A-43
1-23/32	1.7188	43.66	1/4	1C23T-0123	1C23A-0123
-	1.7323	44.00	1/4	1C23T-44	1C23A-44
1-3/4	1.7500	44.45	1/4	1C23T-0124	1C23A-0124
-	1.7717	45.00	1/4	1C23T-45	1C23A-45
1-25/32	1.7813	45.24	1/4	1C23T-0125	1C23A-0125
-	1.7913	45.50	1/4	1C23T-45.5	1C23A-45.5
-	1.7970	45.64	1/4	1C23T-1.797	1C23A-1.797
-	1.8110	46.00	1/4	1C23T-46	1C23A-46
1-13/16	1.8125	46.04	1/4	1C23T-0126	1C23A-0126
1-27/32	1.8438	46.83	1/4	1C23T-0127	1C23A-0127
-	1.8504	47.00	1/4	1C23T-47	1C23A-47
1-7/8	1.8750	47.63	1/4	1C23T-0128	1C23A-0128

Inserts sold in quantities of 1

A30: 112 - 143

A30: 82 - 85

A30: 4 - 6

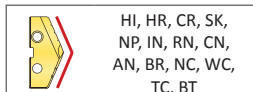
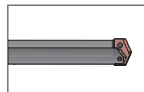
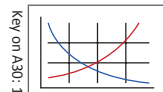

Coatings not listed above can be supplied as non-stocked standards. Process fees apply. →

TiN = 1C23T-XXXX	TiAlN = 1C23A-XXXX
TiCN = 1C23N-XXXX	AM200® = 1C23H-XXXX

**Original T-A Drill Inserts**

3 Series | Carbide | Diameter Range: 1.353" - 1.882" (34.36mm - 47.80mm)

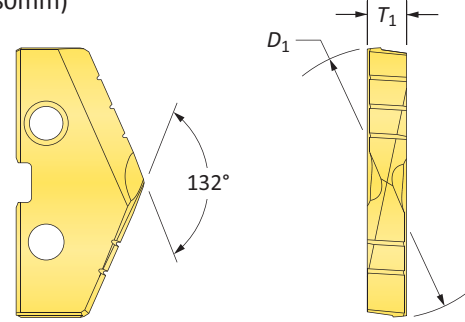

**Carbide Inserts – C5 (P40)**

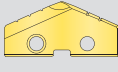
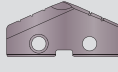
Fractional Equivalent	Insert			Part No.	
	D <sub>1</sub> inch	D <sub>1</sub> mm	T <sub>1</sub>	 TiN	 TiAlN
1-13/32	1.4063	35.72	1/4	1C53T-0113	1C53A-0113
-	1.4173	36.00	1/4	1C53T-36	1C53A-36
1-7/16	1.4375	36.51	1/4	1C53T-0114	1C53A-0114
-	1.4567	37.00	1/4	1C53T-37	1C53A-37
1-15/32	1.4688	37.31	1/4	1C53T-0115	1C53A-0115
-	1.4961	38.00	1/4	1C53T-38	1C53A-38
1-1/2	1.5000	38.10	1/4	1C53T-0116	1C53A-0116
1-17/32	1.5313	38.89	1/4	1C53T-0117	1C53A-0117
-	1.5354	39.00	1/4	1C53T-39	1C53A-39
-	1.5470	39.29	1/4	1C53T-1.547	1C53A-1.547
1-9/16	1.5625	39.69	1/4	1C53T-0118	1C53A-0118
-	1.5748	40.00	1/4	1C53T-40	1C53A-40
1-19/32	1.5938	40.48	1/4	1C53T-0119	1C53A-0119
-	1.6142	41.00	1/4	1C53T-41	1C53A-41
1-5/8	1.6250	41.28	1/4	1C53T-0120	1C53A-0120
-	1.6535	42.00	1/4	1C53T-42	1C53A-42
1-21/32	1.6563	42.07	1/4	1C53T-0121	1C53A-0121
1-11/16	1.6875	42.86	1/4	1C53T-0122	1C53A-0122
-	1.6929	43.00	1/4	1C53T-43	1C53A-43
1-23/32	1.7188	43.66	1/4	1C53T-0123	1C53A-0123
-	1.7323	44.00	1/4	1C53T-44	1C53A-44
1-3/4	1.7500	44.45	1/4	1C53T-0124	1C53A-0124
-	1.7717	45.00	1/4	1C53T-45	1C53A-45
1-25/32	1.7813	45.24	1/4	1C53T-0125	1C53A-0125
-	1.7913	45.50	1/4	1C53T-45.5	1C53A-45.5
-	1.7970	45.64	1/4	1C53T-1.797	1C53A-1.797
-	1.8110	46.00	1/4	1C53T-46	1C53A-46
1-13/16	1.8125	46.04	1/4	1C53T-0126	1C53A-0126
1-27/32	1.8438	46.83	1/4	1C53T-0127	1C53A-0127
-	1.8504	47.00	1/4	1C53T-47	1C53A-47
1-7/8	1.8750	47.63	1/4	1C53T-0128	1C53A-0128

A30: 112 - 143

A30: 82 - 85

A30: 4 - 6

HI, HR, CR, SK,  
NP, IN, RN, CN,  
AN, BR, NC, WC,  
TC, BT

Coatings not listed above can be supplied as non-stocked standards. Process fees apply. →

TiN = 1C53T-XXXX	TiAlN = 1C53A-XXXX
TiCN = 1C53N-XXXX	AM200® = 1C53H-XXXX

Inserts sold in quantities of 1

## T-A Drill Insert Holders

3 Series | Flange Shank | Diameter Range: 1.353" - 1.882" (34.36mm - 47.80mm)

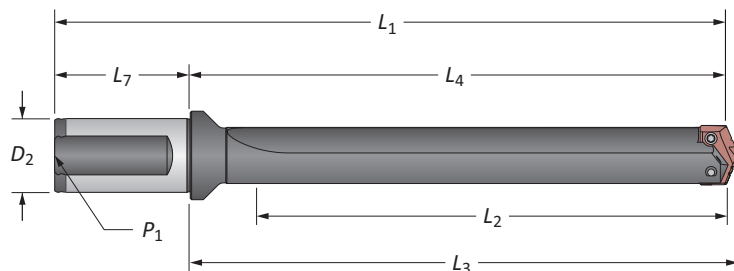

### Straight Flute

Length	Body				Shank			Part No.
	$L_2$	$L_4$	$L_3$	$L_1$	$D_2$	$L_7$	$P_1$	
<b>i</b> Short	4-3/4	6-13/16	7	9-1/2	1-1/2	2-11/16	1/4	22030S-150F
<b>i</b> Intermediate	6-1/2	8-9/16	8-3/4	11-1/4	1-1/2	2-11/16	1/4	23030S-150F
<b>i</b> Standard	8-1/4	10-5/16	10-1/2	13	1-1/2	2-11/16	1/4	24030S-150F
<b>m</b> Short	120.7	173.0	177.8	243.0	40.0	70.0	1/4*	22030S-40FM
<b>m</b> Extended	349.3	401.6	406.4	471.6	40.0	70.0	1/4*	<b>▲ 25030S-40FM</b>
<b>m</b> XL	558.8	611.1	615.9	681.1	40.0	70.0	1/4*	<b>▲ 27030S-40FM</b>
<b>m</b> 3XL	787.4	839.7	844.5	909.7	40.0	70.0	1/4*	<b>▲ 29030S-40FM</b>

\*Metric thread to BSP and ISO 7-1

**NOTE:** Stub length holders have a 1/4" side pipe tap ( $P_2$ )

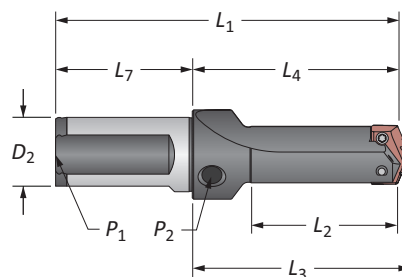

### Straight Flute (Stub Length)

Length	Body				Shank			Part No.
	$L_2$	$L_4$	$L_3$	$L_1$	$D_2$	$L_7$	$P_1$	
<b>i</b> Stub	3	4-59/64	5-7/64	7-39-64	1-1/2	2-11/16	1/4	21030S-150F
<b>m</b> Stub	76.2	125.0	129.8	195.0	40.0	70.0	1/4*	21030S-40FM

\*Metric thread to BSP and ISO 7-1

**NOTE:** Stub length holders have a 1/4" side pipe tap ( $P_2$ )

### Connection Accessories

Insert Screws	Nylon Locking Screws	Insert Driver	Preset Torque Hand Driver	Replacement Tips	Admissible Tightening Torque*
7514-IP20-1	7514N-IP20-1	8IP-20	-	-	121.3 in-lbs (1370 N-cm)

\*Tightening torques are calculated with a friction coefficient of  $\mu = 0.14$  and develop 90% of ultimate yield strength

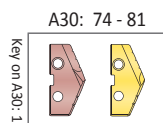

**i** = Imperial (in)

**m** = Metric (mm)

Screws sold in quantities of 10

**WARNING** Refer to Speed and Feed charts for recommended adjustments to speeds and feeds. Refer to page A30: 146 for deep hole drilling guidelines in this section of the catalog. Visit [www.alliedmachine.com/DeepHoleGuidelines](http://www.alliedmachine.com/DeepHoleGuidelines) for the most up-to-date information and procedures. Factory technical assistance is available for your specific applications through our Application Engineering Team.

### T-A Drill Insert Holders

3 Series | Flange Shank | Diameter Range: 1.353" - 1.882" (34.36mm - 47.80mm)

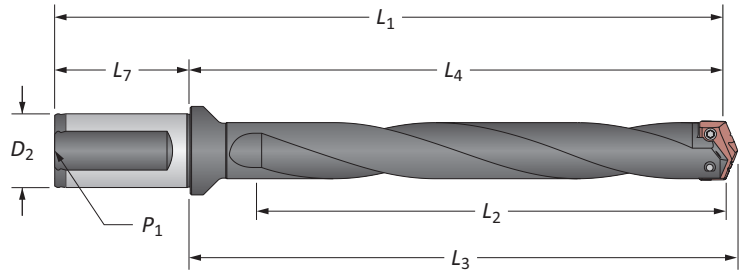

#### Helical Flute

Length	Body				Shank			Part No.	
	L <sub>2</sub>	L <sub>4</sub>	L <sub>3</sub>	L <sub>1</sub>	D <sub>2</sub>	L <sub>7</sub>	P <sub>1</sub>		
i	Intermediate	6-1/2	8-9/16	8-3/4	11-1/4	1-1/2	2-11/16	1/4	23030H-150F
	Standard	8-1/4	10-5/16	10-1/2	13	1-1/2	2-11/16	1/4	24030H-150F
m	Intermediate	165.1	217.5	222.3	287.5	40.0	70.0	1/4*	23030H-40FM
	Standard	209.6	261.9	266.7	331.9	40.0	70.0	1/4*	24030H-40FM

\*Metric thread to BSP and ISO 7-1

#### Connection Accessories

Insert Screws	Nylon Locking Screws	Insert Driver	Preset Torque Hand Driver	Replacement Tips	Admissible Tightening Torque*
7514-IP20-1	7514N-IP20-1	8IP-20	-	-	121.3 in-lbs (1370 N-cm)

\*Tightening torques are calculated with a friction coefficient of  $\mu = 0.14$  and develop 90% of ultimate yield strength

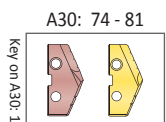

Key on A30-1

i = Imperial (in)  
m = Metric (mm)

Screws sold in quantities of 10

## T-A Drill Insert Holders

3 Series | Taper Shank | Diameter Range: 1.353" - 1.882" (34.36mm - 47.80mm)

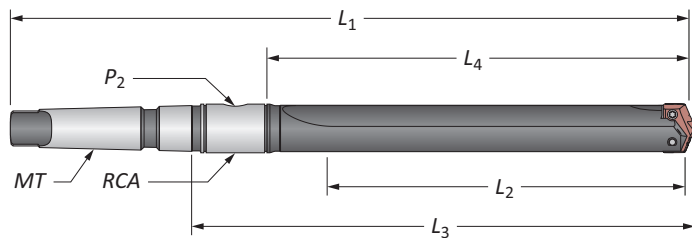

### Straight Flute

Length	Body				Shank			Part No.
	L <sub>2</sub>	L <sub>4</sub>	L <sub>3</sub>	L <sub>1</sub>	MT	P <sub>2</sub>	RCA	
Short	4-3/4	6	8-1/8	12-9/16	#4	1/4	2T-4SR	22030S-004I
Short	4-3/4	6	8-1/8	13-13/16	#5	1/4	2T-5SR	22030S-005I
Intermediate	6-1/2	7-3/4	9-7/8	14-5/16	#4	1/4	2T-4SR	23030S-004I
Standard	8-1/4	9-1/2	11-5/8	16-1/16	#4	1/4	2T-4SR	24030S-004I
Standard	8-1/4	9-1/2	11-5/8	17-5/16	#5	1/4	2T-5SR	24030S-005I
Extended	13-3/4	15	17-1/8	21-9/16	#4	1/4	2T-4SR	25030S-004I
XL	22	22-1/4	25-3/8	29-13/16	#4	1/4	2T-4SR	27030S-004I
3XL	31	32-1/4	34-3/8	38-13/16	#4	1/4	2T-4SR	29030S-004I
Short	120.6	152.4	206.4	319.1	#4**	1/4*	2T-4SRM	22030S-004M
Extended	349.3	381.0	435.0	547.7	#4**	1/4*	2T-4SRM	25030S-004M
XL	558.8	590.6	644.6	757.2	#4**	1/4*	2T-4SRM	27030S-004M
3XL	787.4	819.2	873.2	985.8	#4**	1/4*	2T-4SRM	29030S-004M

\*Metric thread to BSP and ISO 7-1

\*\*Per ISO 296 type BEK

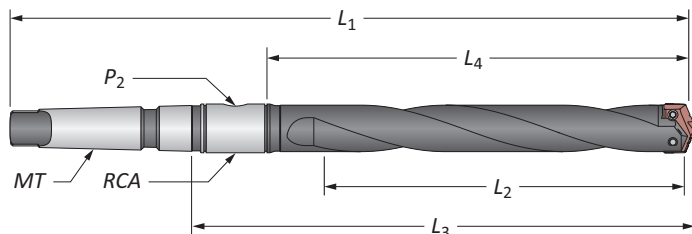

### Helical Flute

Length	Body				Shank			Part No.
	L <sub>2</sub>	L <sub>4</sub>	L <sub>3</sub>	L <sub>1</sub>	MT	P <sub>2</sub>	RCA	
Intermediate	165.1	196.9	250.9	363.6	#4**	1/4*	2T-4SRM	23030H-004M
Standard	209.5	241.3	295.3	408.0	#4**	1/4*	2T-4SRM	24030H-004M

\*Metric thread to BSP and ISO 7-1 | \*\*Per ISO 296 type BEK

### Connection Accessories

Insert Screws	Nylon Locking Screws	Insert Driver	Preset Torque Hand Driver	Replacement Tips	Admissible Tightening Torque*
7514-IP20-1	7514N-IP20-1	8IP-20	-	-	121.3 in-lbs (1370 N-cm)

\*Tightening torques are calculated with a friction coefficient of  $\mu = 0.14$  and develop 90% of ultimate yield strength

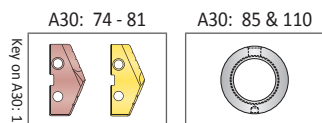

**i** = Imperial (in)

**m** = Metric (mm)

Screws sold in quantities of 10

**WARNING** Refer to Speed and Feed charts for recommended adjustments to speeds and feeds. Refer to page A30: 146 for deep hole drilling guidelines in this section of the catalog. Visit [www.alliedmachine.com/DeepHoleGuidelines](http://www.alliedmachine.com/DeepHoleGuidelines) for the most up-to-date information and procedures. Factory technical assistance is available for your specific applications through our Application Engineering Team.



### T-A Drill Insert Holders

3 Series | Straight Shank | Diameter Range: 1.353" - 1.882" (34.36mm - 47.80mm)

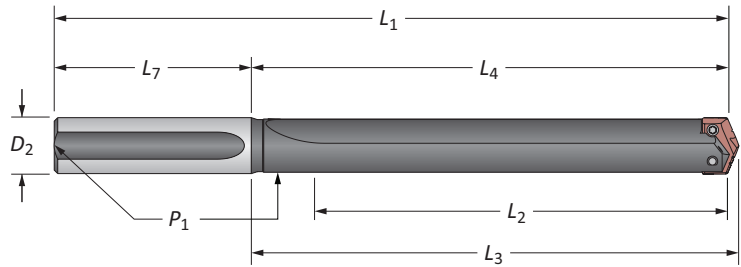

#### Straight Flute

Length	Body				Shank			Part No.
	L <sub>2</sub>	L <sub>4</sub>	L <sub>3</sub>	L <sub>1</sub>	D <sub>2</sub>	L <sub>7</sub>	P <sub>1</sub>	
Short	4-3/4	6	6-3/16	10	1-1/4	4	1/4	22030S-125L
Short	4-3/4	6	6-3/16	10	1-1/2	4	1/4	23030S-150L
Intermediate	6-1/2	7-3/4	7-15/16	11-3/4	1-1/2	4	1/4	23030S-150L
Standard	8-1/4	9-1/2	9-11/16	13-1/2	1-1/4	4	1/4	24030S-125L
Standard	8-1/4	9-1/2	9-11/16	13-1/2	1-1/2	4	1/4	24030S-150L
Extended	13-3/4	15-3/16	15-3/16	19	1-1/4	4	1/4	25030S-125L
XL	22	23-7/16	23-7/16	27-1/4	1-1/2	4	1/4	27030S-150L
3XL	31	32-7/16	32-7/16	36-1/4	1-1/2	4	1/4	29030S-150L

### T-A Drill Accessories

3 Series | Rotary Coolant Adapters | Torx® Plus Screws

#### Rotary Coolant Adapter (RCA) and Accessories

ID	OD	L <sub>1</sub>	Driving Rod Thread	P <sub>1</sub>	Part No.	RCA O-Rings	
						Kit Part No.**	Replacements
1-1/4	2-1/2	1-3/8	3/8-16	1/4	2T-4SR	2T1-4SR	2T1-4OR-10
1-3/4	3	1-3/8	3/8-16	1/4	2T-5SR	2T1-5SR	2T1-5OR-10
31.75	63.50	34.92	M10 x 1.50	1/4*	2T-4SRM	2T1-4SR	2T1-4OR-10
44.45	76.20	34.92	M10 x 1.50	1/4*	2T-5SRM	2T1-5SR	2T1-5OR-10

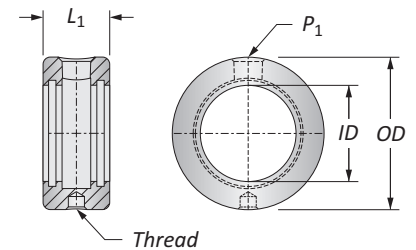

\*Thread to BSP and ISO 7-1

\*\*RCA Repair Kit includes (2) O-rings, (2) snap rings, and (2) thrust washers

Refer to page A30: 110 for proper RCA assembly and safety information

#### Connection Accessories

Insert Screws	Nylon Locking Screws	Insert Driver	Preset Torque Hand Driver	Replacement Tips	Admissible Tightening Torque*
7514-IP20-1	7514N-IP20-1	8IP-20	-	-	121.3 in-lbs (1370 N-cm)

\*Tightening torques are calculated with a friction coefficient of  $\mu = 0.14$  and develop 90% of ultimate yield strength

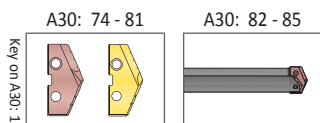

ⓘ = Imperial (in)

Ⓜ = Metric (mm)

Inserts sold separately  
Screws sold in packs of 10  
O-rings sold in packs of 10

**WARNING** Refer to Speed and Feed charts for recommended adjustments to speeds and feeds. Refer to page A30: 146 for deep hole drilling guidelines in this section of the catalog. Visit [www.alliedmachine.com/DeepHoleGuidelines](http://www.alliedmachine.com/DeepHoleGuidelines) for the most up-to-date information and procedures. Factory technical assistance is available for your specific applications through our Application Engineering Team.

## GEN2 T-A Drill Inserts

4 Series | HSS | Diameter Range: 1.850" - 2.570" (46.99mm - 65.28mm)

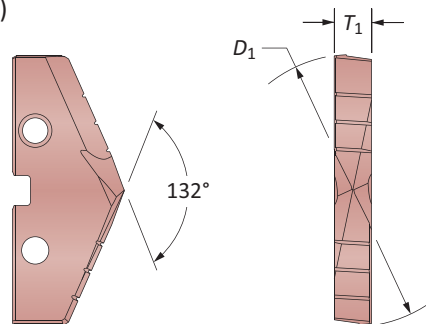

### HSS Inserts – Super Cobalt

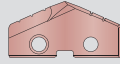
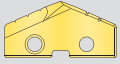
Fractional Equivalent	Insert			Part No.	
	$D_1$ inch	$D_1$ mm	$T_1$	 AM200®	 TiN
–	1.8898	48.00	5/16	454H-48	454T-48
1-29/32	1.9063	48.42	5/16	454H-0129	454T-0129
–	1.9291	49.00	5/16	454H-49	454T-49
1-15/16	1.9375	49.21	5/16	454H-0130	454T-0130
–	1.9685	50.00	5/16	454H-50	454T-50
1-31/32	1.9688	50.01	5/16	454H-0131	454T-0131
2	2.0000	50.80	5/16	454H-0200	454T-0200
–	2.0079	51.00	5/16	454H-51	454T-51
2-1/32	2.0313	51.59	5/16	454H-0201	454T-0201
2-3/64	2.0472	52.00	5/16	454H-52	454T-52
2-1/16	2.0625	52.39	5/16	454H-0202	454T-0202
–	2.0866	53.00	5/16	454H-53	454T-53
2-3/32	2.0938	53.18	5/16	454H-0203	454T-0203
2-1/8	2.1250	53.98	5/16	454H-0204	454T-0204
–	2.1260	54.00	5/16	454H-54	454T-54
2-5/32	2.1563	54.77	5/16	454H-0205	454T-0205
–	2.1654	55.00	5/16	454H-55	454T-55
2-3/16	2.1875	55.56	5/16	454H-0206	454T-0206
–	2.2047	56.00	5/16	454H-56	454T-56
2-7/32	2.2188	56.36	5/16	454H-0207	454T-0207
–	2.2441	57.00	5/16	454H-57	454T-57
2-1/4	2.2500	57.15	5/16	454H-0208	454T-0208
2-9/32	2.2813	57.94	5/16	454H-0209	454T-0209
–	2.2835	58.00	5/16	454H-58	454T-58
2-5/16	2.3125	58.74	5/16	454H-0210	454T-0210
–	2.3228	59.00	5/16	454H-59	454T-59
2-11/32	2.3438	59.53	5/16	454H-0211	454T-0211
–	2.3622	60.00	5/16	454H-60	454T-60
2-3/8	2.3750	60.33	5/16	454H-0212	454T-0212
–	2.4016	61.00	5/16	454H-61	454T-61
2-13/32	2.4063	61.12	5/16	454H-0213	454T-0213
2-7/16	2.4375	61.91	5/16	454H-0214	454T-0214
–	2.4409	62.00	5/16	454H-62	454T-62
2-15/32	2.4688	62.71	5/16	454H-0215	454T-0215
–	2.4803	63.00	5/16	454H-63	454T-63
2-1/2	2.5000	63.50	5/16	454H-0216	454T-0216
–	2.5197	64.00	5/16	454H-64	454T-64
2-17/32	2.5313	64.29	5/16	454H-0217	454T-0217
–	2.5591	65.00	5/16	454H-65	454T-65
2-9/16	2.5625	65.09	5/16	454H-0218	454T-0218

Inserts sold in quantities of 1

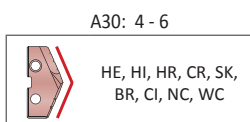
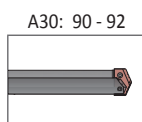
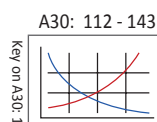

Coatings not listed above  
can be supplied as  
non-stocked standards.  
Process fees apply. →

TiN = 454T-XXXX	TiAlN = 454A-XXXX
TiCN = 454N-XXXX	AM200® = 454H-XXXX



**GEN2 T-A Drill Inserts**

4 Series | HSS | Diameter Range: 1.850" - 2.570" (46.99mm - 65.28mm)

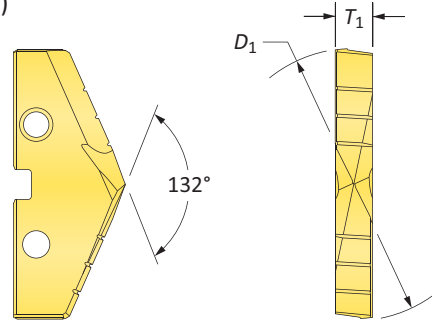

**HSS Inserts – HSS**

Fractional Equivalent	Insert			Part No.
	D <sub>1</sub> inch	D <sub>1</sub> mm	T <sub>1</sub>	
-	1.8898	48.00	5/16	434T-48
1-29/32	1.9063	48.42	5/16	434T-0129
-	1.9291	49.00	5/16	434T-49
1-15/16	1.9375	49.21	5/16	434T-0130
-	1.9685	50.00	5/16	434T-50
1-31/32	1.9688	50.01	5/16	434T-0131
2	2.0000	50.80	5/16	434T-0200
-	2.0079	51.00	5/16	434T-51
2-1/32	2.0313	51.59	5/16	434T-0201
2-3/64	2.0472	52.00	5/16	434T-52
2-1/16	2.0625	52.39	5/16	434T-0202
-	2.0866	53.00	5/16	434T-53
2-3/32	2.0938	53.18	5/16	434T-0203
2-1/8	2.1250	53.98	5/16	434T-0204
-	2.1260	54.00	5/16	434T-54
2-5/32	2.1563	54.77	5/16	434T-0205
-	2.1654	55.00	5/16	434T-55
2-3/16	2.1875	55.56	5/16	434T-0206
-	2.2047	56.00	5/16	434T-56
2-7/32	2.2188	56.36	5/16	434T-0207
-	2.2441	57.00	5/16	434T-57
2-1/4	2.2500	57.15	5/16	434T-0208
2-9/32	2.2813	57.94	5/16	434T-0209
-	2.2835	58.00	5/16	434T-58
2-5/16	2.3125	58.74	5/16	434T-0210
-	2.3228	59.00	5/16	434T-59
2-11/32	2.3438	59.53	5/16	434T-0211
-	2.3622	60.00	5/16	434T-60
2-3/8	2.3750	60.33	5/16	434T-0212
-	2.4016	61.00	5/16	434T-61
2-13/32	2.4063	61.12	5/16	434T-0213
2-7/16	2.4375	61.91	5/16	434T-0214
-	2.4409	62.00	5/16	434T-62
2-15/32	2.4688	62.71	5/16	434T-0215
-	2.4803	63.00	5/16	434T-63
2-1/2	2.5000	63.50	5/16	434T-0216
-	2.5197	64.00	5/16	434T-64
2-17/32	2.5313	64.29	5/16	434T-0217
-	2.5591	65.00	5/16	434T-65
2-9/16	2.5625	65.09	5/16	434T-0218

A30: 112 - 143 A30: 90 - 92 A30: 4 - 6

HE, HI, HR, CR, SK, BR, CI, NC, WC

Coatings not listed above can be supplied as non-stocked standards. Process fees apply. →

TiN = 434T-XXXX	TiAlN = 434A-XXXX
TiCN = 434N-XXXX	AM200® = 434H-XXXX

Inserts sold in quantities of 1

## Original T-A Drill Inserts

4 Series | HSS | Diameter Range: 1.850" - 2.570" (46.99mm - 65.28mm)

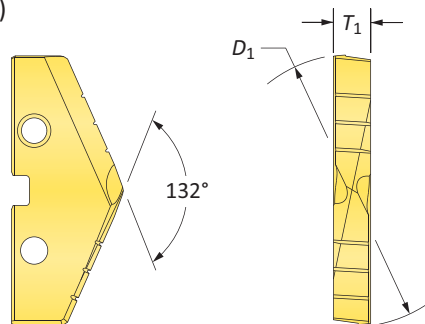

### HSS Inserts – Super Cobalt

Fractional Equivalent	Insert			Part No.
	$D_1$ inch	$D_1$ mm	$T_1$	
-	1.8898	48.00	5/16	<b>154T-48</b>
1-29/32	1.9063	48.42	5/16	<b>154T-0129</b>
-	1.9291	49.00	5/16	<b>154T-49</b>
1-15/16	1.9375	49.21	5/16	<b>154T-0130</b>
-	1.9685	50.00	5/16	<b>154T-50</b>
1-31/32	1.9688	50.01	5/16	<b>154T-0131</b>
2	2.0000	50.80	5/16	<b>154T-0200</b>
-	2.0079	51.00	5/16	<b>154T-51</b>
2-1/32	2.0313	51.59	5/16	<b>154T-0201</b>
2-3/64	2.0472	52.00	5/16	<b>154T-52</b>
2-1/16	2.0625	52.39	5/16	<b>154T-0202</b>
-	2.0866	53.00	5/16	<b>154T-53</b>
2-3/32	2.0938	53.18	5/16	<b>154T-0203</b>
2-1/8	2.1250	53.98	5/16	<b>154T-0204</b>
-	2.1260	54.00	5/16	<b>154T-54</b>
2-5/32	2.1563	54.77	5/16	<b>154T-0205</b>
-	2.1654	55.00	5/16	<b>154T-55</b>
2-3/16	2.1875	55.56	5/16	<b>154T-0206</b>
-	2.2047	56.00	5/16	<b>154T-56</b>
2-7/32	2.2188	56.36	5/16	<b>154T-0207</b>
-	2.2441	57.00	5/16	<b>154T-57</b>
2-1/4	2.2500	57.15	5/16	<b>154T-0208</b>
2-9/32	2.2813	57.94	5/16	<b>154T-0209</b>
-	2.2835	58.00	5/16	<b>154T-58</b>
2-5/16	2.3125	58.74	5/16	<b>154T-0210</b>
-	2.3228	59.00	5/16	<b>154T-59</b>
2-11/32	2.3438	59.53	5/16	<b>154T-0211</b>
-	2.3622	60.00	5/16	<b>154T-60</b>
2-3/8	2.3750	60.33	5/16	<b>154T-0212</b>
-	2.4016	61.00	5/16	<b>154T-61</b>
2-13/32	2.4063	61.12	5/16	<b>154T-0213</b>
2-7/16	2.4375	61.91	5/16	<b>154T-0214</b>
-	2.4409	62.00	5/16	<b>154T-62</b>
2-15/32	2.4688	62.71	5/16	<b>154T-0215</b>
-	2.4803	63.00	5/16	<b>154T-63</b>
2-1/2	2.5000	63.50	5/16	<b>154T-0216</b>
-	2.5197	64.00	5/16	<b>154T-64</b>
2-17/32	2.5313	64.29	5/16	<b>154T-0217</b>
-	2.5591	65.00	5/16	<b>154T-65</b>
2-9/16	2.5625	65.09	5/16	<b>154T-0218</b>

Inserts sold in quantities of 1

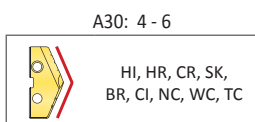
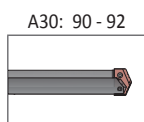
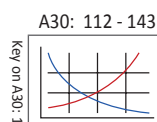

Coatings not listed above can be supplied as non-stocked standards. Process fees apply. →

TiN = 154T-XXXX	TiAlN = 154A-XXXX
TiCN = 154N-XXXX	AM200® = 154H-XXXX



### Original T-A Drill Inserts

4 Series | HSS | Diameter Range: 1.850" - 2.570" (46.99mm - 65.28mm)



Flat Bottom

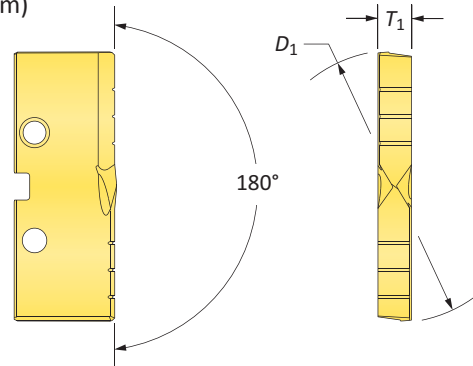

#### HSS Inserts – Super Cobalt

Fractional Equivalent	Insert			Part No.
	D <sub>1</sub> inch	D <sub>1</sub> mm	T <sub>1</sub>	
-	1.8898	48.00	5/16	154T-48-FB
1-29/32	1.9063	48.42	5/16	154T-0129-FB
-	1.9291	49.00	5/16	154T-49-FB
1-15/16	1.9375	49.21	5/16	154T-0130-FB
-	1.9685	50.00	5/16	154T-50-FB
1-31/32	1.9688	50.01	5/16	154T-0131-FB
2	2.0000	50.80	5/16	154T-0200-FB
-	2.0079	51.00	5/16	154T-51-FB
2-1/32	2.0313	51.59	5/16	154T-0201-FB
2-3/64	2.0472	52.00	5/16	154T-52-FB
2-1/16	2.0625	52.39	5/16	154T-0202-FB
-	2.0866	53.00	5/16	154T-53-FB
2-3/32	2.0938	53.18	5/16	154T-0203-FB
2-1/8	2.1250	53.98	5/16	154T-0204-FB
-	2.1260	54.00	5/16	154T-54-FB
2-5/32	2.1563	54.77	5/16	154T-0205-FB
-	2.1654	55.00	5/16	154T-55-FB
2-3/16	2.1875	55.56	5/16	154T-0206-FB
-	2.2047	56.00	5/16	154T-56-FB
2-7/32	2.2188	56.36	5/16	154T-0207-FB
-	2.2441	57.00	5/16	154T-57-FB
2-1/4	2.2500	57.15	5/16	154T-0208-FB
2-9/32	2.2813	57.94	5/16	154T-0209-FB
-	2.2835	58.00	5/16	154T-58-FB
2-5/16	2.3125	58.74	5/16	154T-0210-FB
-	2.3228	59.00	5/16	154T-59-FB
2-11/32	2.3438	59.53	5/16	154T-0211-FB
-	2.3622	60.00	5/16	154T-60-FB
2-3/8	2.3750	60.33	5/16	154T-0212-FB
-	2.4016	61.00	5/16	154T-61-FB
2-13/32	2.4063	61.12	5/16	154T-0213-FB
2-7/16	2.4375	61.91	5/16	154T-0214-FB
-	2.4409	62.00	5/16	154T-62-FB
2-15/32	2.4688	62.71	5/16	154T-0215-FB
-	2.4803	63.00	5/16	154T-63-FB
2-1/2	2.5000	63.50	5/16	154T-0216-FB
-	2.5197	64.00	5/16	154T-64-FB
2-17/32	2.5313	64.29	5/16	154T-0217-FB
-	2.5591	65.00	5/16	154T-65-FB
2-9/16	2.5625	65.09	5/16	154T-0218-FB

A30: 112 - 143

A30: 90 - 92

A30: 4 - 6

Coatings not listed above can be supplied as non-stocked standards. Process fees apply. →

TiN = 154T-XXXX	TiAlN = 154A-XXXX
TiCN = 154N-XXXX	AM200® = 154H-XXXX

Inserts sold in quantities of 1

## T-A Drill Insert Holders

4 Series | Flange Shank | Diameter Range: 1.850" - 2.570" (46.99mm - 65.28mm)

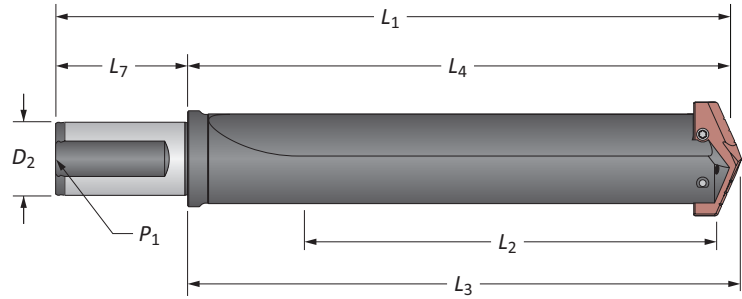

### Straight Flute

Length	Body				Shank			Part No.
	L <sub>2</sub>	L <sub>4</sub>	L <sub>3</sub>	L <sub>1</sub>	D <sub>2</sub>	L <sub>7</sub>	P <sub>1</sub>	
<b>i</b> Short	5-1/8	7-1/6	7-1/4	9-3/4	1-1/2	2-11/16	1/4	22040S-150F
<b>i</b> Standard	9-1/8	11-1/16	11-1/4	13-3/4	1-1/2	2-11/16	1/4	24040S-150F
<b>m</b> Short	130.2	179.4	184.0	249.4	40.0	70.0	1/4*	22040S-40FM
<b>m</b> Extended	422.3	471.5	476.0	541.5	40.0	70.0	1/4*	25040S-40FM
<b>m</b> XL	625.0	674.7	679.0	744.7	40.0	70.0	1/4*	27040S-40FM
<b>m</b> 3XL	879.0	928.7	933.0	998.7	40.0	70.0	1/4*	29040S-40FM

\*Metric thread to BSP and ISO 7-1

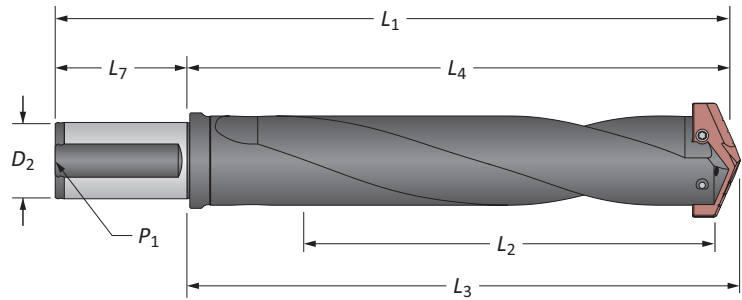

### Helical Flute

Length	Body				Shank			Part No.
	L <sub>2</sub>	L <sub>4</sub>	L <sub>3</sub>	L <sub>1</sub>	D <sub>2</sub>	L <sub>7</sub>	P <sub>1</sub>	
<b>i</b> Standard	9-1/8	11-1/16	11-1/4	13-3/4	1-1/2	2-11/16	1/4	24040H-150F
<b>m</b> Standard	231.8	281.0	285.8	351.0	40.0	70.0	1/4*	24040H-40FM

\*Metric thread to BSP and ISO 7-1

### Connection Accessories

Insert Screws	Nylon Locking Screws	Insert Driver	Preset Torque Hand Driver	Replacement Tips	Admissible Tightening Torque*
7514-IP20-1	7514N-IP20-1	8IP-20	-	-	121.3 in-lbs (1370 N-cm)

\*Tightening torques are calculated with a friction coefficient of  $\mu = 0.14$  and develop 90% of ultimate yield strength

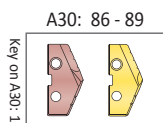

**i** = Imperial (in)

**m** = Metric (mm)

Screws sold in quantities of 10

**WARNING** Refer to Speed and Feed charts for recommended adjustments to speeds and feeds. Refer to page A30: 146 for deep hole drilling guidelines in this section of the catalog. Visit [www.alliedmachine.com/DeepHoleGuidelines](http://www.alliedmachine.com/DeepHoleGuidelines) for the most up-to-date information and procedures. Factory technical assistance is available for your specific applications through our Application Engineering Team.

## T-A Drill Insert Holders

4 Series | Taper Shank | Diameter Range: 1.850" - 2.570" (46.99mm - 65.28mm)

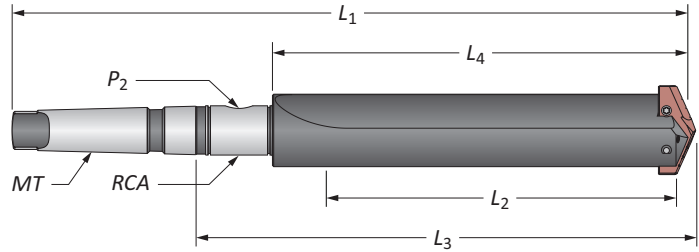

### Straight Flute

	Length	Body				Shank			Part No.
		L <sub>2</sub>	L <sub>4</sub>	L <sub>3</sub>	L <sub>1</sub>	MT	P <sub>2</sub>	RCA	
i	Short	5-1/8	6-1/2	8-5/8	13-1/16	#4	1/4	2T-4SR	22040S-004I
	Short	5-1/8	6-1/2	8-5/8	14-5/16	#5	1/4	2T-5SR	22040S-005I
	Standard	9-1/8	10-1/2	12-5/8	17-1/16	#4	1/4	2T-4SR	24040S-004I
	Standard	9-1/8	10-1/2	12-5/8	18-5/16	#5	1/4	2T-5SR	24040S-005I
	Extended	16-5/8	18	20-1/8	25-13/16	#5	1/4	2T-5SR	25040S-005I
	XL	24-5/8	26	28-1/8	33-13/16	#5	1/4	2T-5SR	27040S-005I
m	3XL	34-5/8	36	38-1/8	43-13/16	#5	1/4	2T-5SR	29040S-005I
	Short	130.1	165.1	219.1	363.5	#5**	1/4*	2T-5SRM	22040S-005M
	Extended	422.3	457.2	511.2	655.6	#5**	1/4*	2T-5SRM	25040S-005M
	XL	625.0	660.4	714.4	858.8	#5**	1/4*	2T-5SRM	27040S-005M
	3XL	879.0	914.4	968.4	1112.8	#5**	1/4*	2T-5SRM	29040S-005M

\*Metric thread to BSP and ISO 7-1

\*\*Per ISO 296 type BEK

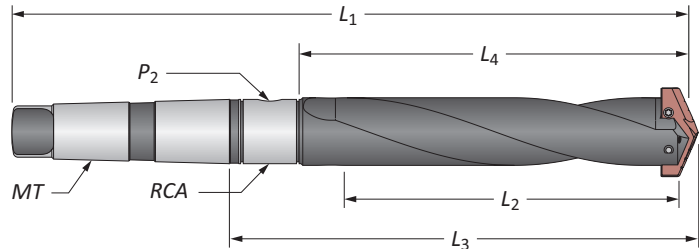

### Helical Flute

	Length	Body				Shank			Part No.
		L <sub>2</sub>	L <sub>4</sub>	L <sub>3</sub>	L <sub>1</sub>	MT	P <sub>2</sub>	RCA	
m	Standard	231.8	266.7	320.7	465.1	#5**	1/4*	2T-5SRM	24040H-005M

\*Metric thread to BSP and ISO 7-1

\*\*Per ISO 296 type BEK

### Connection Accessories

Insert Screws	Nylon Locking Screws	Insert Driver	Preset Torque Hand Driver	Replacement Tips	Admissible Tightening Torque*
7514-IP20-1	7514N-IP20-1	8IP-20	-	-	121.3 in-lbs (1370 N-cm)

\*Tightening torques are calculated with a friction coefficient of  $\mu = 0.14$  and develop 90% of ultimate yield strength

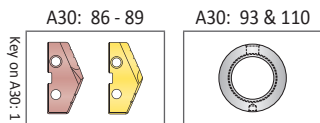

i = Imperial (in)

m = Metric (mm)

Screws sold in quantities of 10

**WARNING** Refer to Speed and Feed charts for recommended adjustments to speeds and feeds. Refer to page A30: 146 for deep hole drilling guidelines in this section of the catalog. Visit [www.alliedmachine.com/DeepHoleGuidelines](http://www.alliedmachine.com/DeepHoleGuidelines) for the most up-to-date information and procedures. Factory technical assistance is available for your specific applications through our Application Engineering Team.

## T-A Drill Insert Holders

4 Series | Straight Shank | Diameter Range: 1.850" - 2.570" (46.99mm - 65.28mm)

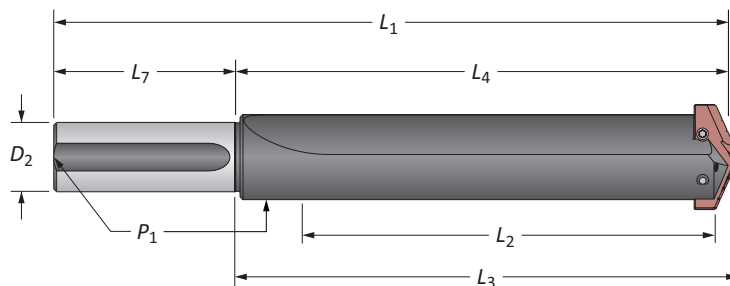

### Straight Flute

Length	Body				Shank			Part No.
	L <sub>2</sub>	L <sub>4</sub>	L <sub>3</sub>	L <sub>1</sub>	D <sub>2</sub>	L <sub>7</sub>	P <sub>1</sub>	
Short	5-1/8	6-1/2	6-11/16	10-1/2	1-1/2	4	1/4	22040S-150L
Short	5-1/8	6-1/2	6-11/16	10-1/2	1-3/4	4	1/4	22040S-175L
Standard	9-1/8	10-1/2	10-11/16	14-1/2	1-1/2	4	1/4	24040S-150L
Standard	9-1/8	10-1/2	10-11/16	14-1/2	1-3/4	4	1/4	24040S-175L
Extended	16-5/8	18	18-3/16	22	1-1/2	4	1/4	25040S-150L
XL	24-5/8	26	26-3/16	30	1-1/2	4	1/4	27040S-150L
3XL	34-5/8	36	36-3/16	40	1-1/2	4	1/4	29040S-150L

### Connection Accessories

Insert Screws	Nylon Locking Screws	Insert Driver	Preset Torque Hand Driver	Replacement Tips	Admissible Tightening Torque*
7514-IP20-1	7514N-IP20-1	8IP-20	-	-	121.3 in-lbs (1370 N-cm)

\*Tightening torques are calculated with a friction coefficient of  $\mu = 0.14$  and develop 90% of ultimate yield strength

A30: 86 - 89

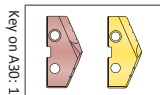

**i** = Imperial (in)

**m** = Metric (mm)

Screws sold in quantities of 10

**WARNING** Refer to Speed and Feed charts for recommended adjustments to speeds and feeds. Refer to page A30: 146 for deep hole drilling guidelines in this section of the catalog. Visit [www.alliedmachine.com/DeepHoleGuidelines](http://www.alliedmachine.com/DeepHoleGuidelines) for the most up-to-date information and procedures. Factory technical assistance is available for your specific applications through our Application Engineering Team.





T-A Drill Accessories

4 Series | Rotary Coolant Adapters | Torx® Plus Screws

Rotary Coolant Adapter (RCA) and Accessories

	ID	OD	L <sub>1</sub>	Driving Rod Thread	P <sub>1</sub>	Part No.	RCA O-Rings	
							Kit Part No.**	Replacements
i	1-1/4	2-1/2	1-3/8	3/8-16	1/4	⚠ 2T-4SR	2T1-4SR	2T1-4OR-10
	1-3/4	3	1-3/8	3/8-16	1/4	⚠ 2T-5SR	2T1-5SR	2T1-5OR-10
m	31.75	63.50	34.92	M10 x 1.50	1/4*	⚠ 2T-4SRM	2T1-4SR	2T1-4OR-10
	44.45	76.20	34.92	M10 x 1.50	1/4*	⚠ 2T-5SRM	2T1-5SR	2T1-5OR-10

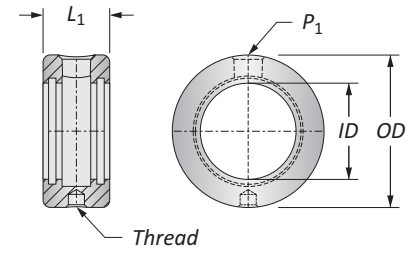

\*Thread to BSP and ISO 7-1

\*\*RCA Repair Kit includes (2) O-rings, (2) snap rings, and (2) thrust washers

⚠ Refer to page A30: 110 for proper RCA assembly and safety information

Connection Accessories

Insert Screws	Nylon Locking Screws	Insert Driver	Preset Torque Hand Driver	Replacement Tips	Admissible Tightening Torque*
7514-IP20-1	7514N-IP20-1	8IP-20	-	-	121.3 in-lbs (1370 N-cm)

\*Tightening torques are calculated with a friction coefficient of  $\mu = 0.14$  and develop 90% of ultimate yield strength

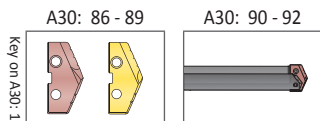

Key on A30: 1

i = Imperial (in)  
m = Metric (mm)

Inserts sold separately  
Screws sold in packs of 10  
O-rings sold in packs of 10

**⚠ WARNING** Refer to Speed and Feed charts for recommended adjustments to speeds and feeds. Refer to page A30: 146 for deep hole drilling guidelines in this section of the catalog. Visit [www.alliedmachine.com/DeepHoleGuidelines](http://www.alliedmachine.com/DeepHoleGuidelines) for the most up-to-date information and procedures. Factory technical assistance is available for your specific applications through our Application Engineering Team.

A DRILLING  
B BORING  
C REAMING  
D BURNISHING  
E THREADING  
X SPECIALS

## GEN2 T-A Drill Inserts

5 Series | HSS | Diameter Range: 2.456" - 3.000" (62.38mm - 76.20mm)

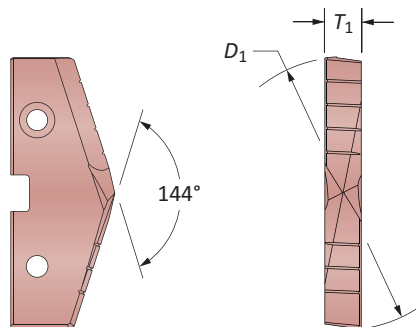

HSS Inserts – Super Cobalt | HSS

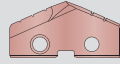
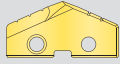
Fractional Equivalent	Insert			Super Cobalt Part No.	HSS Part No.
	$D_1$ inch	$D_1$ mm	$T_1$	 AM200®	 TiN
2-1/2	2.5000	63.50	7/16	455H-0216	435T-0216
-	2.5197	64.00	7/16	455H-64	435T-64
2-17/32	2.5313	64.29	7/16	455H-0217	435T-0217
2-9/16	2.5625	65.09	7/16	455H-0218	435T-0218
2-19/32	2.5938	65.88	7/16	455H-0219	435T-0219
-	2.5984	66.00	7/16	455H-66	435T-66
2-5/8	2.6250	66.68	7/16	455H-0220	435T-0220
2-21/32	2.6563	67.47	7/16	455H-0221	435T-0221
-	2.6772	68.00	7/16	455H-68	435T-68
2-11/16	2.6875	68.26	7/16	455H-0222	435T-0222
2-23/32	2.7188	69.05	7/16	455H-0223	435T-0223
2-3/4	2.7500	69.85	7/16	455H-0224	435T-0224
-	2.7559	70.00	7/16	455H-70	435T-70
2-25/32	2.7813	70.64	7/16	455H-0225	435T-0225
2-13/16	2.8125	71.44	7/16	455H-0226	435T-0226
-	2.8346	72.00	7/16	455H-72	435T-72
2-27/32	2.8438	72.23	7/16	455H-0227	435T-0227
2-7/8	2.8750	73.03	7/16	455H-0228	435T-0228
2-29/32	2.9063	73.82	7/16	455H-0229	435T-0229
-	2.9134	74.00	7/16	455H-74	435T-74
2-15/16	2.9375	74.41	7/16	455H-0230	435T-0230
2-31/32	2.9688	75.61	7/16	455H-0231	435T-0231
-	2.9921	76.00	7/16	455H-76	435T-76
3	3.0000	76.20	7/16	455H-0300	435T-0300

F

THREADING

X

SPECIALS

A30: 112 - 143

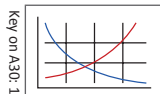

A30: 98 - 100

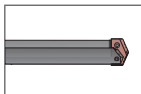

A30: 4 - 6

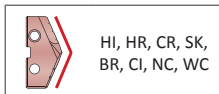

Coatings not listed above  
can be supplied as  
non-stocked standards.  
Process fees apply. →

TiN = 455T-XXXX

TiAlN = 455A-XXXX

TiCN = 455N-XXXX

AM200® = 455H-XXXX

Inserts sold in quantities of 1



### Original T-A Drill Inserts

5 Series | HSS | Diameter Range: 2.456" - 3.000" (62.38mm - 76.20mm)

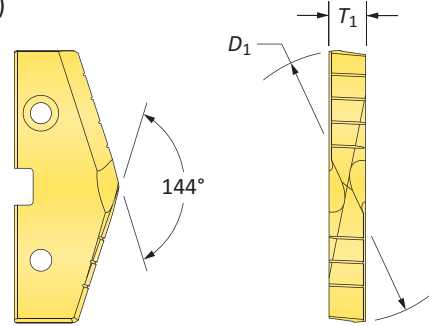

HSS Inserts – Super Cobalt | HSS

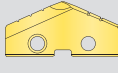
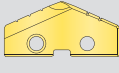
Fractional Equivalent	Insert			Super Cobalt Part No.*	HSS Part No.
	D <sub>1</sub> inch	D <sub>1</sub> mm	T <sub>1</sub>	 TiN	 TiN
2-1/2	2.5000	63.50	7/16	155T-0216	135T-0216
-	2.5197	64.00	7/16	155T-64	135T-64
2-17/32	2.5313	64.29	7/16	155T-0217	135T-0217
2-9/16	2.5625	65.09	7/16	155T-0218	135T-0218
2-19/32	2.5938	65.88	7/16	155T-0219	135T-0219
-	2.5984	66.00	7/16	155T-66	135T-66
2-5/8	2.6250	66.68	7/16	155T-0220	135T-0220
2-21/32	2.6563	67.47	7/16	155T-0221	135T-0221
-	2.6772	68.00	7/16	155T-68	135T-68
2-11/16	2.6875	68.26	7/16	155T-0222	135T-0222
2-23/32	2.7188	69.05	7/16	155T-0223	135T-0223
2-3/4	2.7500	69.85	7/16	155T-0224	135T-0224
-	2.7559	70.00	7/16	155T-70	135T-70
2-25/32	2.7813	70.64	7/16	155T-0225	135T-0225
2-13/16	2.8125	71.44	7/16	155T-0226	135T-0226
-	2.8346	72.00	7/16	155T-72	135T-72
2-27/32	2.8438	72.23	7/16	155T-0227	135T-0227
2-7/8	2.8750	73.03	7/16	155T-0228	135T-0228
2-29/32	2.9063	73.82	7/16	155T-0229	135T-0229
-	2.9134	74.00	7/16	155T-74	135T-74
2-15/16	2.9375	74.41	7/16	155T-0230	135T-0230
2-31/32	2.9688	75.61	7/16	155T-0231	135T-0231
-	2.9921	76.00	7/16	155T-76	135T-76
3	3.0000	76.20	7/16	155T-0300	135T-0300

\*Available as non-stocked standard

A30: 112 - 143

A30: 98 - 100

A30: 4 - 6

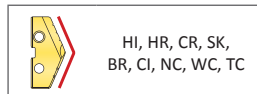
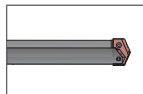
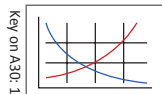

Inserts sold in quantities of 1

Coatings not listed above can be supplied as non-stocked standards. Process fees apply. →

TiN = 155T-XXXX	TiAlN = 155A-XXXX
TiCN = 155N-XXXX	AM200® = 155H-XXXX

A  
DRILLING  
B  
BORING  
C  
REAMING  
D  
BURNISHING  
E  
THREADING  
X  
SPECIALS



## GEN2 T-A Drill Inserts

6 Series | HSS | Diameter Range: 3.001" - 3.507" (76.22mm - 89.08mm)

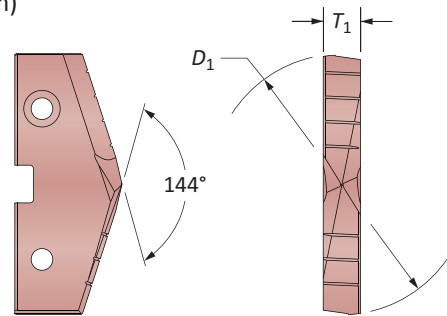
(for use with 5 series holders)

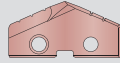

HSS Inserts – Super Cobalt | HSS

Fractional Equivalent	Insert			Super Cobalt Part No.	HSS Part No.
	$D_1$ inch	$D_1$ mm	$T_1$	 AM200®	 TiN
3-1/32	3.0313	76.99	7/16	456H-0301	436T-0301
3-1/16	3.0625	77.79	7/16	456H-0302	436T-0302
–	3.0709	78.00	7/16	456H-78	436T-78
3-3/32	3.0938	78.58	7/16	456H-0303	436T-0303
3-1/8	3.1250	79.38	7/16	456H-0304	436T-0304
–	3.1496	80.00	7/16	456H-80	436T-80
3-5/32	3.1563	80.17	7/16	456H-0305	436T-0305
3-3/16	3.1875	80.96	7/16	456H-0306	436T-0306
3-7/32	3.2188	81.76	7/16	456H-0307	436T-0307
–	3.2283	82.00	7/16	456H-82	436T-82
3-1/4	3.2500	82.55	7/16	456H-0308	436T-0308
3-9/32	3.2813	83.34	7/16	456H-0309	436T-0309
–	3.3071	84.00	7/16	456H-84	436T-84
3-5/16	3.3125	84.14	7/16	456H-0310	436T-0310
3-11/32	3.3438	84.93	7/16	456H-0311	436T-0311
3-3/8	3.3750	85.73	7/16	456H-0312	436T-0312
–	3.3858	86.00	7/16	456H-86	436T-86
3-13/32	3.4063	86.52	7/16	456H-0313	436T-0313
3-7/16	3.4375	87.31	7/16	456H-0314	436T-0314
–	3.4646	88.00	7/16	456H-88	436T-88
3-15/32	3.4688	88.11	7/16	456H-0315	436T-0315
3-1/2	3.5000	88.90	7/16	456H-0316	436T-0316

B

BORING

C

REAMING

D

BURNISHING

E

THREADING

X

SPECIALS

Inserts sold in quantities of 1

A30: 112 - 143

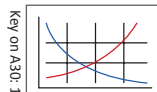

A30: 98 - 100

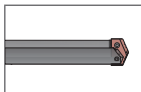

A30: 4 - 6

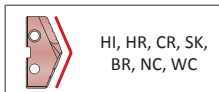

Coatings not listed above  
can be supplied as  
non-stocked standards.  
Process fees apply. →

TiN = 456T-XXXX

TiAlN = 456A-XXXX

TiCN = 456N-XXXX

AM200® = 456H-XXXX



### Original T-A Drill Inserts

6 Series | HSS | Diameter Range: 3.001" - 3.507" (76.22mm - 89.08mm)

(for use with 5 series holders)

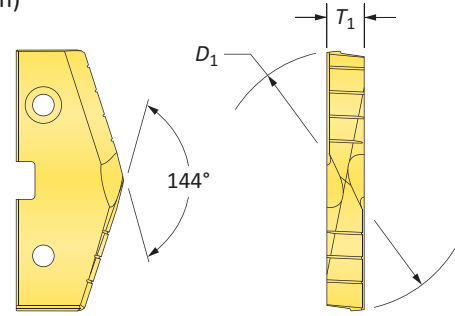

HSS Inserts – Super Cobalt | HSS

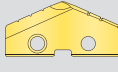
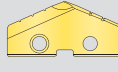
Fractional Equivalent	Insert			Super Cobalt Part No.*	HSS Part No.
	$D_1$ inch	$D_1$ mm	$T_1$	 TiN	 TiN
3-1/32	3.0313	76.99	7/16	156T-0301	136T-0301
3-1/16	3.0625	77.79	7/16	156T-0302	136T-0302
-	3.0709	78.00	7/16	156T-78	136T-78
3-3/32	3.0938	78.58	7/16	156T-0303	136T-0303
3-1/8	3.1250	79.38	7/16	156T-0304	136T-0304
-	3.1496	80.00	7/16	156T-80	136T-80
3-5/32	3.1563	80.17	7/16	156T-0305	136T-0305
3-3/16	3.1875	80.96	7/16	156T-0306	136T-0306
3-7/32	3.2188	81.76	7/16	156T-0307	136T-0307
-	3.2283	82.00	7/16	156T-82	136T-82
3-1/4	3.2500	82.55	7/16	156T-0308	136T-0308
3-9/32	3.2813	83.34	7/16	156T-0309	136T-0309
-	3.3071	84.00	7/16	156T-84	136T-84
3-5/16	3.3125	84.14	7/16	156T-0310	136T-0310
3-11/32	3.3438	84.93	7/16	156T-0311	136T-0311
3-3/8	3.3750	85.73	7/16	156T-0312	136T-0312
-	3.3858	86.00	7/16	156T-86	136T-86
3-13/32	3.4063	86.52	7/16	156T-0313	136T-0313
3-7/16	3.4375	87.31	7/16	156T-0314	136T-0314
-	3.4646	88.00	7/16	156T-88	136T-88
3-15/32	3.4688	88.11	7/16	156T-0315	136T-0315
3-1/2	3.5000	88.90	7/16	156T-0316	136T-0316

\*Available as non-stocked standard

Key on A30-1

A30: 112 - 143

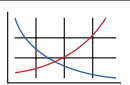

A30: 98 - 100



A30: 4 - 6



HI, HR, CR, SK,  
BR, NC, WC, TC

Coatings not listed above can be supplied as non-stocked standards. Process fees apply. →

TiN = 156T-XXXX	TiAlN = 156A-XXXX
TiCN = 156N-XXXX	AM200® = 156H-XXXX

Inserts sold in quantities of 1

## T-A Drill Insert Holders

5 Series | Flange Shank | Diameter Range: 2.456" - 3.507" (62.38mm - 89.08mm)

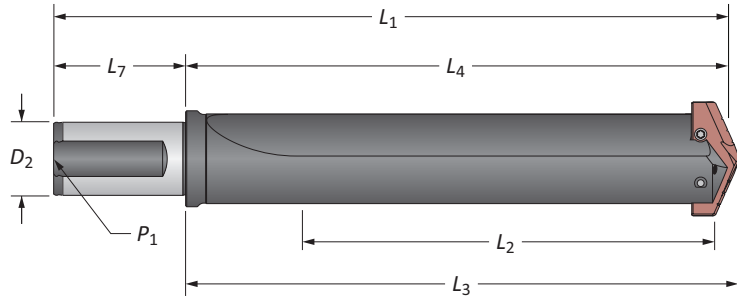

### Straight Flute

Length	Body				Shank			Part No.
	L <sub>2</sub>	L <sub>4</sub>	L <sub>3</sub>	L <sub>1</sub>	D <sub>2</sub>	L <sub>7</sub>	P <sub>1</sub>	
<b>i</b> Short	6-49/64	8-1/2	8-3/4	13-1/4	2	4-1/2	1/2	22050S-200F
Extended	18-17/64	20	20-1/4	24-3/4	2	4-1/2	1/2	25050S-200F
<b>m</b> Short	172	215.9	222.3	302.3	50.0	80.0	1/2*	22050S-50FM
Extended	464	508	514.4	594.4	50.0	80.0	1/2*	25050S-50FM

\*Metric thread to BSP and ISO 7-1

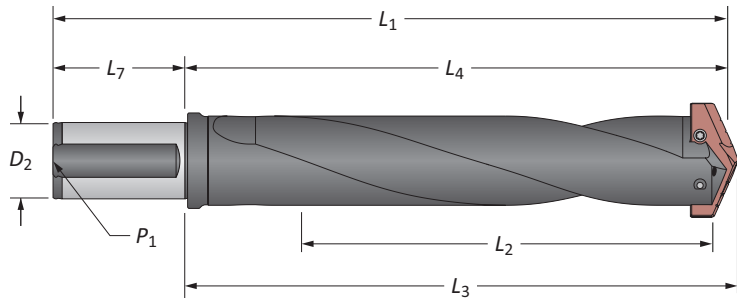

### Helical Flute

Length	Body				Shank			Part No.
	L <sub>2</sub>	L <sub>4</sub>	L <sub>3</sub>	L <sub>1</sub>	D <sub>2</sub>	L <sub>7</sub>	P <sub>1</sub>	
<b>i</b> Standard	10-3/4	12-1/2	12-3/4	17-1/4	2	4-1/2	1/2	24050H-200F
<b>m</b> Standard	273	317.5	323.9	403.9	50.0	80.0	1/2*	24050H-50FM

\*Metric thread to BSP and ISO 7-1

### Connection Accessories

Insert Screws	Nylon Locking Screws	Insert Driver	Preset Torque Hand Driver	Replacement Tips	Admissible Tightening Torque*
7619-IP25-1	-	8IP-25	-	-	155.0 in-lbs (1750 N-cm)

\*Tightening torques are calculated with a friction coefficient of  $\mu = 0.14$  and develop 90% of ultimate yield strength

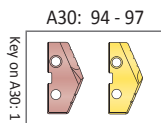

**i** = Imperial (in)  
**m** = Metric (mm)

Screws sold in quantities of 10

**WARNING** Refer to Speed and Feed charts for recommended adjustments to speeds and feeds. Refer to page A30: 146 for deep hole drilling guidelines in this section of the catalog. Visit [www.alliedmachine.com/DeepHoleGuidelines](http://www.alliedmachine.com/DeepHoleGuidelines) for the most up-to-date information and procedures. Factory technical assistance is available for your specific applications through our Application Engineering Team.



## T-A Drill Insert Holders

5 Series | Taper Shank | Diameter Range: 2.456" - 3.507" (62.38mm - 89.08mm)

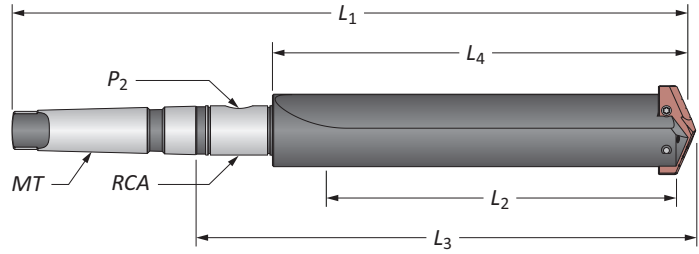

### Straight Flute

	Length	Body				Shank			Part No.
		L <sub>2</sub>	L <sub>4</sub>	L <sub>3</sub>	L <sub>1</sub>	MT	P <sub>2</sub>	RCA	
i	Short	6-3/4	8-1/2	11-5/16	16-15/16	#5	1/2	2T-6SR	22050S-005I
	Standard	10-3/4	12-1/2	15-5/16	20-15/16	#5	1/2	2T-6SR	24050S-005I
	Extended	18-1/4	20	22-13/16	28-7/16	#5	1/2	2T-6SR	25050S-005I
	XL	26	27-3/4	30-9/16	36-3/16	#5	1/2	2T-6SR	27050S-005I
	3XL	35	36-3/4	39-9/16	45-3/16	#5	1/2	2T-6SR	29050S-005I
m	Short	171.5	215.9	287.3	430.2	#5**	1/2*	2T-6SRM	22050S-005M
	Extended	463.6	508.0	579.4	722.3	#5**	1/2*	2T-6SRM	25050S-005M
	XL	660.0	704.8	776.2	919.1	#5**	1/2*	2T-6SRM	27050S-005M
	3XL	889.0	933.4	1004.8	1147.7	#5**	1/2*	2T-6SRM	29050S-005M

\*Metric thread to BSP and ISO 7-1

\*\*Per ISO 296 type BEK

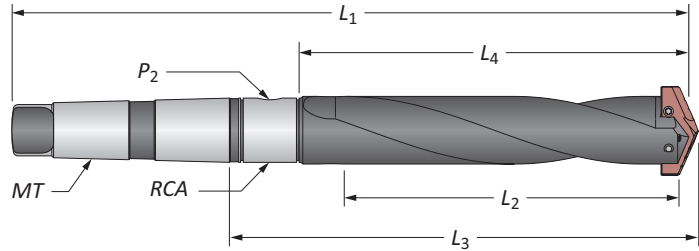

### Helical Flute

	Length	Body				Shank			Part No.
		L <sub>2</sub>	L <sub>4</sub>	L <sub>3</sub>	L <sub>1</sub>	MT	P <sub>2</sub>	RCA	
m	Standard	273.1	317.5	388.9	531.8	#5**	1/2*	2T-6SRM	24050H-005M

\*Metric thread to BSP and ISO 7-1

\*\*Per ISO 296 type BEK

### Connection Accessories

Insert Screws	Nylon Locking Screws	Insert Driver	Preset Torque Hand Driver	Replacement Tips	Admissible Tightening Torque*
7619-IP25-1	-	8IP-25	-	-	155.0 in-lbs (1750 N-cm)

\*Tightening torques are calculated with a friction coefficient of  $\mu = 0.14$  and develop 90% of ultimate yield strength

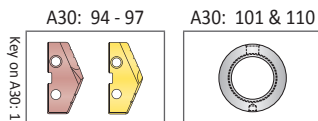

i = Imperial (in)

m = Metric (mm)

Screws sold in quantities of 10

**WARNING** Refer to Speed and Feed charts for recommended adjustments to speeds and feeds. Refer to page A30: 146 for deep hole drilling guidelines in this section of the catalog. Visit [www.alliedmachine.com/DeepHoleGuidelines](http://www.alliedmachine.com/DeepHoleGuidelines) for the most up-to-date information and procedures. Factory technical assistance is available for your specific applications through our Application Engineering Team.

## T-A Drill Insert Holders

5 Series | Straight Shank | Diameter Range: 2.456" - 3.507" (62.38mm - 89.08mm)

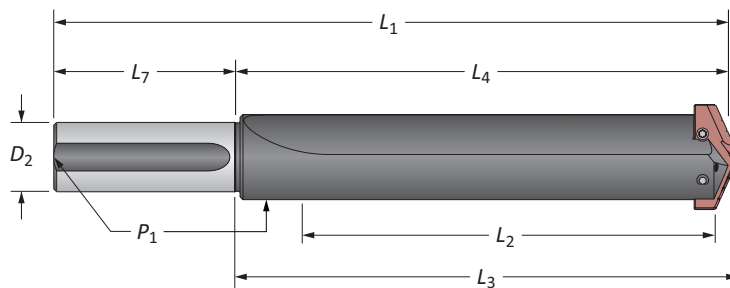

### Straight Flute

Length	Body				Shank			Part No.
	L <sub>2</sub>	L <sub>4</sub>	L <sub>3</sub>	L <sub>1</sub>	D <sub>2</sub>	L <sub>7</sub>	P <sub>1</sub>	
Short	6-3/4	8-1/2	8-3/4	12-1/2	2	4	1/2	22050S-200L
Standard	10-3/4	12-1/2	12-3/4	16-1/2	2	4	1/2	24050S-200L
Extended	18-1/4	20	20-1/4	24	2	4	1/2	25050S-200L
XL	26	27-3/4	28	31-3/4	2	4	1/2	27050S-200L
3XL	35	36-3/4	37	40-3/4	2	4	1/2	29050S-200L

### Connection Accessories

Insert Screws	Nylon Locking Screws	Insert Driver	Preset Torque Hand Driver	Replacement Tips	Admissible Tightening Torque*
7619-IP25-1	-	8IP-25	-	-	155.0 in-lbs (1750 N-cm)

\*Tightening torques are calculated with a friction coefficient of  $\mu = 0.14$  and develop 90% of ultimate yield strength

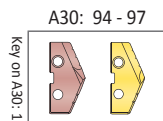

i = Imperial (in)  
m = Metric (mm)

Screws sold in quantities of 10

**WARNING** Refer to Speed and Feed charts for recommended adjustments to speeds and feeds. Refer to page A30: 146 for deep hole drilling guidelines in this section of the catalog. Visit [www.alliedmachine.com/DeepHoleGuidelines](http://www.alliedmachine.com/DeepHoleGuidelines) for the most up-to-date information and procedures. Factory technical assistance is available for your specific applications through our Application Engineering Team.





## T-A Drill Accessories

5/6 Series | Rotary Coolant Adapters | Torx® Plus Screws

### Rotary Coolant Adapter (RCA) and Accessories

ID	OD	L <sub>1</sub>	Driving Rod Thread	P <sub>1</sub>	Part No.	RCA O-Rings	
						Kit Part No.**	Replacements
<b>i</b> 2-1/4	3-3/4	1-3/4	1/2-13	1/2	<b>⚠</b> 2T-6SR	2T1-6SR	2T1-6OR-10
<b>m</b> 57.15	95.27	44.45	M12 x 1.75	1/2*	<b>⚠</b> 2T-6SRM	2T1-6SR	2T1-6OR-10

\*Thread to BSP and ISO 7-1

\*\*RCA Repair Kit includes (2) O-rings, (2) snap rings, and (2) thrust washers

**⚠** Refer to page A30: 110 for proper RCA assembly and safety information

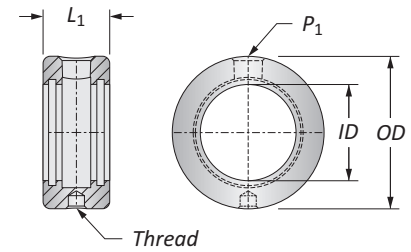

### Connection Accessories

Insert Screws	Nylon Locking Screws	Insert Driver	Preset Torque Hand Driver	Replacement Tips	Admissible Tightening Torque*
7619-IP25-1	-	8IP-25	-	-	155.0 in-lbs (1750 N-cm)

\*Tightening torques are calculated with a friction coefficient of  $\mu = 0.14$  and develop 90% of ultimate yield strength

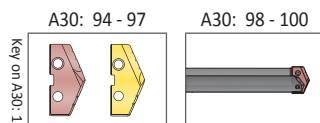

**i** = Imperial (in)  
**m** = Metric (mm)  
 Inserts sold separately  
 Screws sold in packs of 10  
 O-rings sold in packs of 10



**⚠ WARNING** Refer to Speed and Feed charts for recommended adjustments to speeds and feeds. Refer to page A30: 146 for deep hole drilling guidelines in this section of the catalog. Visit [www.alliedmachine.com/DeepHoleGuidelines](http://www.alliedmachine.com/DeepHoleGuidelines) for the most up-to-date information and procedures. Factory technical assistance is available for your specific applications through our Application Engineering Team.

## GEN2 T-A Drill Inserts

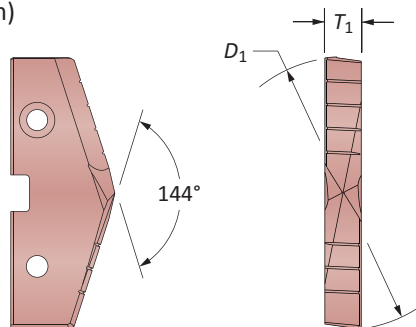
7 Series | HSS | Diameter Range: 3.508" - 4.000" (89.10mm - 101.60mm)

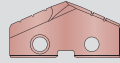

HSS Inserts – Super Cobalt | HSS

Fractional Equivalent	Insert			Super Cobalt Part No.	HSS Part No.
	$D_1$ inch	$D_1$ mm	$T_1$	 AM200®	 TiN
3-17/32	3.5313	89.69	7/16	457H-0317	437T-0317
–	3.5433	90.00	7/16	457H-90	437T-90
3-9/16	3.5625	90.49	7/16	457H-0318	437T-0318
3-19/32	3.5938	91.28	7/16	457H-0319	437T-0319
–	3.6221	92.00	7/16	457H-92	437T-92
3-5/8	3.6250	92.08	7/16	457H-0320	437T-0320
3-21/32	3.6563	92.87	7/16	457H-0321	437T-0321
3-11/16	3.6875	93.66	7/16	457H-0322	437T-0322
–	3.7008	94.00	7/16	457H-94	437T-94
3-23/32	3.7188	94.46	7/16	457H-0323	437T-0323
3-3/4	3.7500	95.25	7/16	457H-0324	437T-0324
–	3.7795	96.00	7/16	457H-96	437T-96
3-25/32	3.7813	96.04	7/16	457H-0325	437T-0325
3-13/16	3.8125	96.84	7/16	457H-0326	437T-0326
3-27/32	3.8438	97.63	7/16	457H-0327	437T-0327
–	3.8583	98.00	7/16	457H-98	437T-98
3-7/8	3.8750	98.43	7/16	457H-0328	437T-0328
3-29/32	3.9063	99.22	7/16	457H-0329	437T-0329
–	3.9370	100.00	7/16	457H-100	437T-100
3-15/16	3.9375	100.01	7/16	457H-0330	437T-0330
3-31/32	3.9688	100.81	7/16	457H-0331	437T-0331
4	4.0000	101.60	7/16	457H-0400	437T-0400

A30: 112 - 143

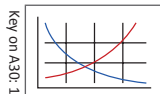

A30: 106 - 108

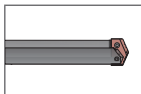

A30: 4 - 6

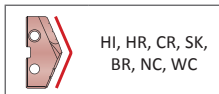

HI, HR, CR, SK,  
BR, NC, WC

Coatings not listed above  
can be supplied as  
non-stocked standards.  
Process fees apply. →

TiN = 457T-XXXX

TiAlN = 457A-XXXX

TiCN = 457N-XXXX

AM200® = 457H-XXXX

Inserts sold in quantities of 1



## Original T-A Drill Inserts

7 Series | HSS | Diameter Range: 3.508" - 4.000" (89.10mm - 101.60mm)

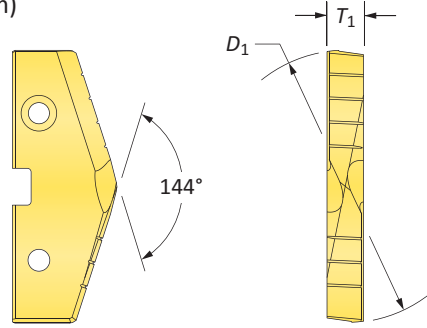

HSS Inserts – Super Cobalt | HSS

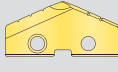
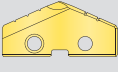
Fractional Equivalent	Insert			Super Cobalt Part No.*	HSS Part No.
	D <sub>1</sub> inch	D <sub>1</sub> mm	T <sub>1</sub>	 TiN	 TiN
3-17/32	3.5313	89.69	7/16	157T-0317	137T-0317
-	3.5433	90.00	7/16	157T-90	137T-90
3-9/16	3.5625	90.49	7/16	157T-0318	137T-0318
3-19/32	3.5938	91.28	7/16	157T-0319	137T-0319
-	3.6221	92.00	7/16	157T-92	137T-92
3-5/8	3.6250	92.08	7/16	157T-0320	137T-0320
3-21/32	3.6563	92.87	7/16	157T-0321	137T-0321
3-11/16	3.6875	93.66	7/16	157T-0322	137T-0322
-	3.7008	94.00	7/16	157T-94	137T-94
3-23/32	3.7188	94.46	7/16	157T-0323	137T-0323
3-3/4	3.7500	95.25	7/16	157T-0324	137T-0324
-	3.7795	96.00	7/16	157T-96	137T-96
3-25/32	3.7813	96.04	7/16	157T-0325	137T-0325
3-13/16	3.8125	96.84	7/16	157T-0326	137T-0326
3-27/32	3.8438	97.63	7/16	157T-0327	137T-0327
-	3.8583	98.00	7/16	157T-98	137T-98
3-7/8	3.8750	98.43	7/16	157T-0328	137T-0328
3-29/32	3.9063	99.22	7/16	157T-0329	137T-0329
-	3.9370	100.00	7/16	157T-100	137T-100
3-15/16	3.9375	100.01	7/16	157T-0330	137T-0330
3-31/32	3.9688	100.81	7/16	157T-0331	137T-0331
4	4.0000	101.60	7/16	157T-0400	137T-0400

\*Available as non-stocked standard

Key on A30-1

A30: 112 - 143

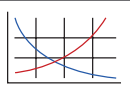

A30: 106 - 108



A30: 4 - 6



HI, HR, CR, SK,  
BR, NC, WC, TC

Coatings not listed above can be supplied as non-stocked standards. Process fees apply. →

Inserts sold in quantities of 1

TiN = 157T-XXXX	TiAlN = 157A-XXXX
TiCN = 157N-XXXX	AM200® = 157H-XXXX



## GEN2 T-A Drill Inserts

8 Series | HSS | Diameter Range: 4.001" - 4.507" (101.63mm - 114.48mm)

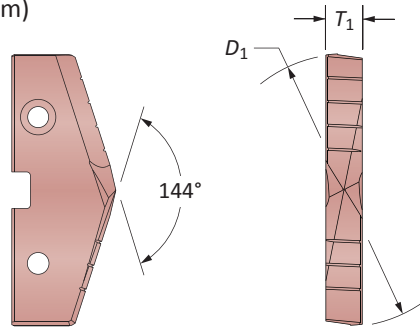
(for use with 7 series holders)

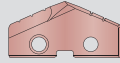

HSS Inserts – Super Cobalt | HSS

Fractional Equivalent	Insert			Super Cobalt Part No.	HSS Part No.
	$D_1$ inch	$D_1$ mm	$T_1$	 AM200®	 TiN
4-1/64	4.0157	102.00	7/16	458H-102	438T-102
4-1/16	4.0625	103.19	7/16	458H-0402	438T-0402
4-3/32	4.0945	104.00	7/16	458H-104	438T-104
4-1/8	4.1250	104.75	7/16	458H-0404	438T-0404
-	4.1732	106.00	7/16	458H-106	438T-106
4-3/16	4.1875	106.36	7/16	458H-0406	438T-0406
4-1/4	4.2500	107.95	7/16	458H-0408	438T-0408
-	4.2520	108.00	7/16	458H-108	438T-108
4-5/16	4.3125	109.54	7/16	458H-0410	438T-0410
-	4.3307	110.00	7/16	458H-110	438T-110
4-3/8	4.3750	111.13	7/16	458H-0412	438T-0412
-	4.4094	112.00	7/16	458H-112	438T-112
4-7/16	4.4375	112.71	7/16	458H-0414	438T-0414
-	4.4882	114.00	7/16	458H-114	438T-114
4-1/2	4.5000	114.30	7/16	458H-0416	438T-0416

D BURNISHING

F THREADING

X SPECIALS

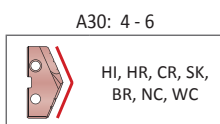
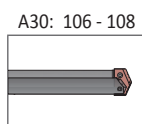
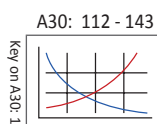

Coatings not listed above  
can be supplied as  
non-stocked standards.  
Process fees apply. →

TiN = 458T-XXXX	TiAlN = 458A-XXXX
TiCN = 458N-XXXX	AM200® = 458H-XXXX

Inserts sold in quantities of 1





## Original T-A Drill Inserts

8 Series | HSS | Diameter Range: 4.001" - 4.507" (101.63mm - 114.48mm)

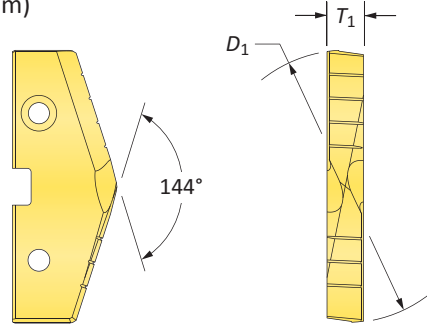
(for use with 7 series holders)

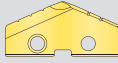

HSS Inserts – Super Cobalt | HSS

Fractional Equivalent	Insert			Super Cobalt Part No.*	HSS Part No.
	$D_1$ inch	$D_1$ mm	$T_1$	 TiN	 TiN
4-1/64	4.0157	102.00	7/16	158T-102	138T-102
4-1/16	4.0625	103.19	7/16	158T-0402	138T-0402
4-3/32	4.0945	104.00	7/16	158T-104	138T-104
4-1/8	4.1250	104.75	7/16	158T-0404	138T-0404
-	4.1732	106.00	7/16	158T-106	138T-106
4-3/16	4.1875	106.36	7/16	158T-0406	138T-0406
4-1/4	4.2500	107.95	7/16	158T-0408	138T-0408
-	4.2520	108.00	7/16	158T-108	138T-108
4-5/16	4.3125	109.54	7/16	158T-0410	138T-0410
-	4.3307	110.00	7/16	158T-110	138T-110
4-3/8	4.3750	111.13	7/16	158T-0412	138T-0412
-	4.4094	112.00	7/16	158T-112	138T-112
4-7/16	4.4375	112.71	7/16	158T-0414	138T-0414
-	4.4882	114.00	7/16	158T-114	138T-114
4-1/2	4.5000	114.30	7/16	158T-0416	138T-0416

\*Available as non-stocked standard

A30: 112 - 143

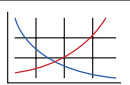

A30: 106 - 108



A30: 4 - 6



HI, HR, CR, SK,  
BR, NC, WC, TC

Coatings not listed above can be supplied as non-stocked standards. Process fees apply. →

TiN = 158T-XXXX	TiAlN = 158A-XXXX
TiCN = 158N-XXXX	AM200® = 158H-XXXX

Inserts sold in quantities of 1

## T-A Drill Insert Holders

7 Series | Flange Shank | Diameter Range: 3.508" - 4.507" (89.10mm - 101.60mm)

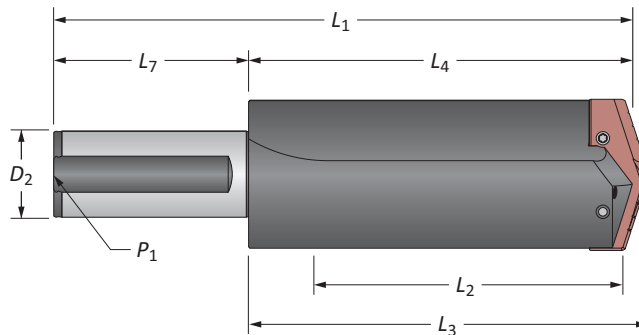

### Straight Flute

Length	Body				Shank			Part No.
	$L_2$	$L_4$	$L_3$	$L_1$	$D_2$	$L_7$	$P_1$	
<b>i</b> Short	6-49/64	8-7/8	9-1/8	13-5/8	2	4-1/2	1/2	<b>22070S-200F</b>
Extended	21-57/64	23-57/64	24-1/4	27-3/4	2	4-1/2	1/2	<b>25070S-200F</b>
<b>m</b> Short	172	225.4	231.8	311.8	50.0	80.0	1/2*	<b>22070S-50FM</b>
Extended	556	606.9	616	696	50.0	80.0	1/2*	<b>25070S-50FM</b>

\*Metric thread to BSP and ISO 7-1

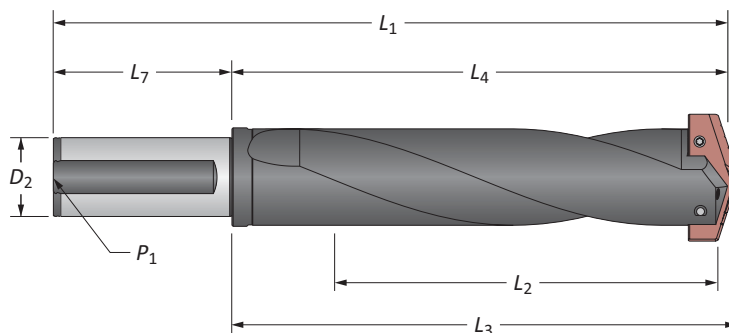

### Helical Flute

Length	Body				Shank			Part No.
	$L_2$	$L_4$	$L_3$	$L_1$	$D_2$	$L_7$	$P_1$	
<b>i</b> Standard	10-3/4	12-7/8	13-1/8	17-5/8	2	4-1/2	1/2	<b>24070H-200F</b>
<b>m</b> Standard	273	327	333.4	413.4	50.0	80.0	1/2*	<b>24070H-50FM</b>

\*Metric thread to BSP and ISO 7-1

### Connection Accessories

Insert Screws	Nylon Locking Screws	Insert Driver	Preset Torque Hand Driver	Replacement Tips	Admissible Tightening Torque*
7619-IP25-1	-	8IP-25	-	-	155.0 in-lbs (1750 N-cm)

\*Tightening torques are calculated with a friction coefficient of  $\mu = 0.14$  and develop 90% of ultimate yield strength

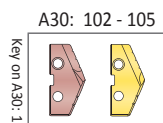

**i** = Imperial (in)

**m** = Metric (mm)

Screws sold in quantities of 10

**WARNING** Refer to Speed and Feed charts for recommended adjustments to speeds and feeds. Refer to page A30: 146 for deep hole drilling guidelines in this section of the catalog. Visit [www.alliedmachine.com/DeepHoleGuidelines](http://www.alliedmachine.com/DeepHoleGuidelines) for the most up-to-date information and procedures. Factory technical assistance is available for your specific applications through our Application Engineering Team.

## T-A Drill Insert Holders

7 Series | Taper Shank | Diameter Range: 3.508" - 4.507" (89.10mm - 101.60mm)

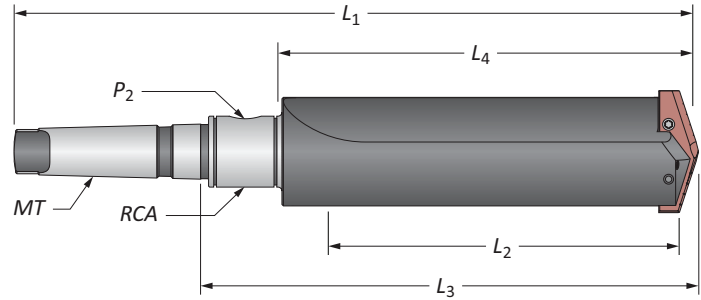

### Straight Flute

	Length	Body				Shank			Part No.
		L <sub>2</sub>	L <sub>4</sub>	L <sub>3</sub>	L <sub>1</sub>	MT	P <sub>2</sub>	RCA	
i	Short	6-3/4	8-7/8	11-11/16	17-5/16	#5	1/2	2T-6SR	22070S-005I
	Standard	10-3/4	12-7/8	15-11/16	21-5/16	#5	1/2	2T-6SR	24070S-005I
	Extended	21-7/8	24	26-13/16	32-7/16	#5	1/2	2T-6SR	▲ 25070S-005I
	XL	27	29-1/8	31-15/16	37-9/16	#5	1/2	2T-6SR	▲ 27070S-005I
	3XL	37	39-1/8	41-5/16	47-9/16	#5	1/2	2T-6SR	▲ 29070S-005I
m	Short	171.5	225.4	296.8	439.7	#5**	1/2*	2T-6SRM	22070S-005M
	Extended	555.6	609.6	681.1	823.9	#5**	1/2*	2T-6SRM	▲ 25070S-005M
	XL	685.0	739.7	811.2	954.0	#5**	1/2*	2T-6SRM	▲ 27070S-005M
	3XL	939.0	993.7	1065.2	1208.0	#5**	1/2*	2T-6SRM	▲ 29070S-005M

\*Metric thread to BSP and ISO 7-1

\*\*Per ISO 296 type BEK

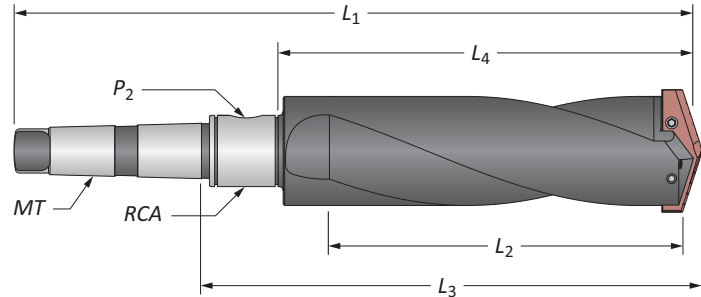

### Helical Flute

	Length	Body				Shank			Part No.
		L <sub>2</sub>	L <sub>4</sub>	L <sub>3</sub>	L <sub>1</sub>	MT	P <sub>2</sub>	RCA	
m	Standard	273.1	327.0	398.5	541.3	#5**	1/2*	2T-6SRM	24070H-005M

\*Metric thread to BSP and ISO 7-1

\*\*Per ISO 296 type BEK

### Connection Accessories

Insert Screws	Nylon Locking Screws	Insert Driver	Preset Torque Hand Driver	Replacement Tips	Admissible Tightening Torque*
7619-IP25-1	-	8IP-25	-	-	155.0 in-lbs (1750 N-cm)

\*Tightening torques are calculated with a friction coefficient of  $\mu = 0.14$  and develop 90% of ultimate yield strength

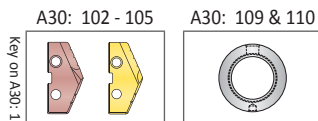

i = Imperial (in)  
m = Metric (mm)

Screws sold in quantities of 10

**WARNING** Refer to Speed and Feed charts for recommended adjustments to speeds and feeds. Refer to page A30: 146 for deep hole drilling guidelines in this section of the catalog. Visit [www.alliedmachine.com/DeepHoleGuidelines](http://www.alliedmachine.com/DeepHoleGuidelines) for the most up-to-date information and procedures. Factory technical assistance is available for your specific applications through our Application Engineering Team.

## T-A Drill Insert Holders

7 Series | Straight Shank | Diameter Range: 3.508" - 4.507" (89.10mm - 101.60mm)

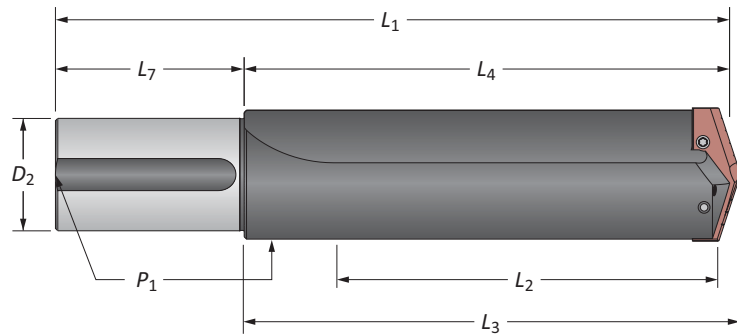

### Straight Flute

Length	Body				Shank			Part No.
	$L_2$	$L_4$	$L_3$	$L_1$	$D_2$	$L_7$	$P_1$	
Short	6-3/4	8-7/8	9-1/8	13-7/8	3	5	1/2	22070S-300L
Standard	10-3/4	12-7/8	13-1/8	17-7/8	3	5	1/2	24070S-300L
<b>i</b> Extended	21-7/8	24	24-1/4	29	3	5	1/2	<b>i</b> 25070S-300L
XL	27	29-1/8	29-3/8	34-1/8	3	5	1/2	<b>i</b> 27070S-300L
3XL	37	39-1/8	39-3/8	44-1/8	3	5	1/2	<b>i</b> 29070S-300L

### Connection Accessories

Insert Screws	Nylon Locking Screws	Insert Driver	Preset Torque Hand Driver	Replacement Tips	Admissible Tightening Torque*
7619-IP25-1	-	8IP-25	-	-	155.0 in-lbs (1750 N-cm)

\*Tightening torques are calculated with a friction coefficient of  $\mu = 0.14$  and develop 90% of ultimate yield strength

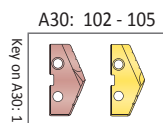

**i** = Imperial (in)

**m** = Metric (mm)

Screws sold in quantities of 10

**WARNING** Refer to Speed and Feed charts for recommended adjustments to speeds and feeds. Refer to page A30: 146 for deep hole drilling guidelines in this section of the catalog. Visit [www.alliedmachine.com/DeepHoleGuidelines](http://www.alliedmachine.com/DeepHoleGuidelines) for the most up-to-date information and procedures. Factory technical assistance is available for your specific applications through our Application Engineering Team.





T-A Drill Accessories

7/8 Series | Rotary Coolant Adapters | Torx® Plus Screws

Rotary Coolant Adapter (RCA) and Accessories

ID	OD	L <sub>1</sub>	Driving Rod Thread	P <sub>1</sub>	Part No.	RCA O-Rings	
						Kit Part No.**	Replacements
<b>i</b> 2-1/4	3-3/4	1-3/4	1/2-13	1/2	<b>⚠</b> 2T-6SR	2T1-6SR	2T1-6OR-10
<b>m</b> 57.15	95.27	44.45	M12 x 1.75	1/2*	<b>⚠</b> 2T-6SRM	2T1-6SR	2T1-6OR-10

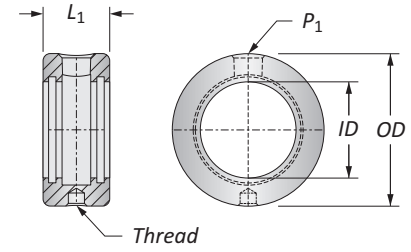

\*Thread to BSP and ISO 7-1

\*\*RCA Repair Kit includes (2) O-rings, (2) snap rings, and (2) thrust washers

**⚠** Refer to page A30: 110 for proper RCA assembly and safety information

Connection Accessories

Insert Screws	Nylon Locking Screws	Insert Driver	Preset Torque Hand Driver	Replacement Tips	Admissible Tightening Torque*
7619-IP25-1	-	8IP-25	-	-	155.0 in-lbs (1750 N-cm)

\*Tightening torques are calculated with a friction coefficient of  $\mu = 0.14$  and develop 90% of ultimate yield strength

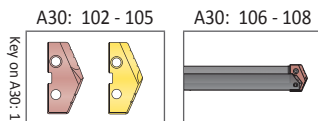

**i** = Imperial (in)  
**m** = Metric (mm)  
 Inserts sold separately  
 Screws sold in packs of 10  
 O-rings sold in packs of 10

**⚠ WARNING** Refer to Speed and Feed charts for recommended adjustments to speeds and feeds. Refer to page A30: 146 for deep hole drilling guidelines in this section of the catalog. Visit [www.alliedmachine.com/DeepHoleGuidelines](http://www.alliedmachine.com/DeepHoleGuidelines) for the most up-to-date information and procedures. Factory technical assistance is available for your specific applications through our Application Engineering Team.

A

DRILLING

B

BORING

C

REAMING

D

BURNISHING

E

THREADING

X

SPECIALS

## Rotary Coolant Adapters (RCA)

### Morse Taper Shanks

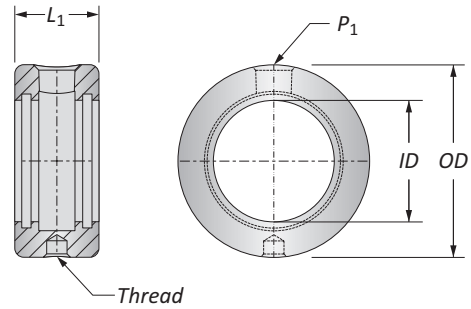

Holder Series	ID	OD	L <sub>1</sub>	Driving Rod Thread	P <sub>1</sub>	Part No.	Max Recommended RPM	RCA O-Rings		
								Kit Part No.**	Replacements	
i	Y, Z, 0	3/4	1-3/4	7/8	5/16 - 18	1/8	⚠ 2T-2SR	3500	2T1-2SR	2T1-2OR-10
	1, 2	1	2-1/8	1-1/8	5/16 - 18	1/8	⚠ 2T-3SR	2500	2T1-3SR	2T1-3OR-10
	2, 3, 4	1-1/4	2-1/2	1-3/8	3/8 - 16	1/4	⚠ 2T-4SR	2000	2T1-4SR	2T1-4OR-10
	3, 4	1-3/4	3	1-3/8	3/8 - 16	1/4	⚠ 2T-5SR	1500	2T1-5SR	2T1-5OR-10
	5, 7	2-1/4	3-3/4	1-3/4	1/2 - 13	1/2	⚠ 2T-6SR	1100	2T1-6SR	2T1-6OR-10
m	Y, Z, 0	19.05	44.45	22.23	M8 x 1.25	1/8*	⚠ 2T-2SRM	3500	2T1-2SR	2T1-2OR-10
	1, 2	25.40	53.97	28.57	M8 x 1.25	1/8*	⚠ 2T-3SRM	2500	2T1-3SR	2T1-3OR-10
	2, 3, 4	31.75	63.50	34.92	M10 x 1.50	1/4*	⚠ 2T-4SRM	2000	2T1-4SR	2T1-4OR-10
	3, 4	44.45	76.20	34.92	M10 x 1.50	1/4*	⚠ 2T-5SRM	1500	2T1-5SR	2T1-5OR-10
	5, 7	57.15	95.27	44.45	M12 x 1.75	1/2*	⚠ 2T-6SRM	1100	2T1-6SR	2T1-6OR-10

\*Thread to BSP and ISO 7-1

\*\*RCA Repair Kit includes (2) O-rings, (2) snap rings, and (2) thrust washers

**NOTE:** Max recommended pressure is 600 PSI (42 bar)

**NOTE:** Recommendations above are based on water and oil based coolants

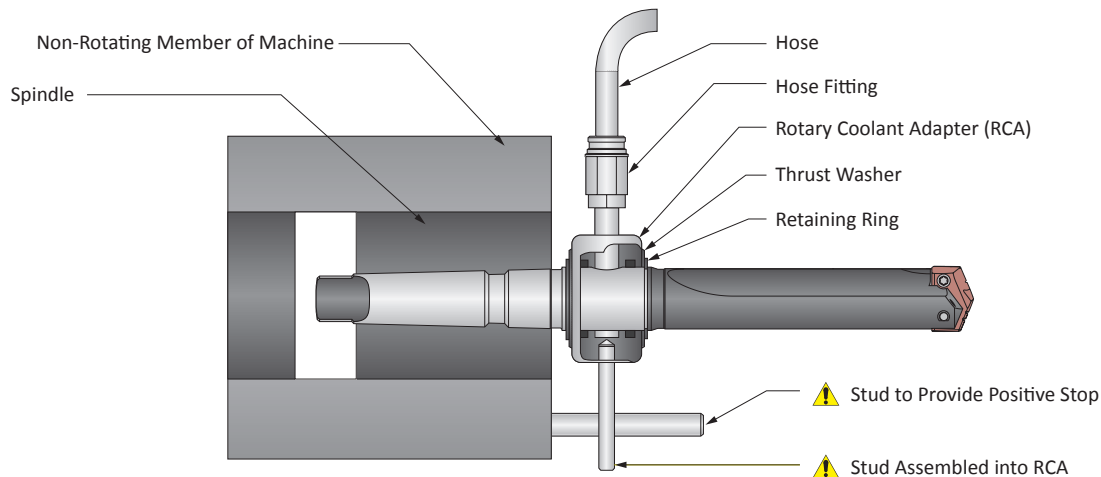

i = Imperial (in)

m = Metric (mm)



O-rings sold in packs of 10

**⚠ WARNING** RCA rotation during drilling can cause hose and/or hose fitting failure, machinery damage, and/or serious injury. To prevent, use RCA and positive stop studs when drilling. Factory technical assistance is also available for your specific applications.

## T-ACR 45 Chamfer Rings

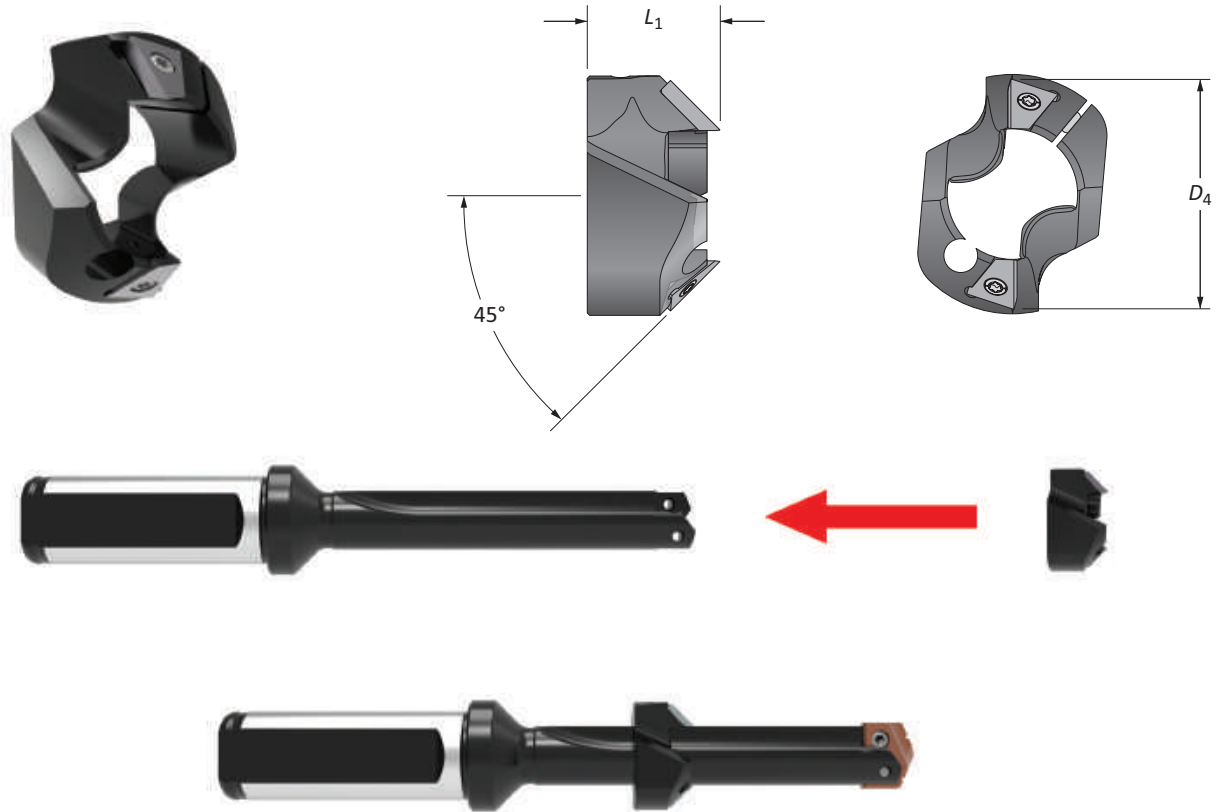
Straight Flute Holders



Holder Series	D <sub>1</sub> Range	Chamfer Ring		Part No.	 Insert Part No.	 Insert Screw	Insert Driver	 Clamping Screw	Insert Driver
		D <sub>4</sub>	L <sub>1</sub>						
0	0.5118 - 0.6890	13/16	0.676	<b>T-ACR-45-0</b>	T-ACRI-45-B-C5A	7255-IP8-1	8IP-8	7375-IP9-1	8IP-9
1	0.6900 - 0.9600	1-3/64	51/64	<b>T-ACR-45-1</b>	T-ACRI-45-B-C5A	7255-IP8-1	8IP-8	7495-IP15-1	8IP-15
1.5	0.8540 - 0.9600	1-1/8	57/64	<b>T-ACR-45-1.5</b>	T-ACRI-45-B-C5A	7255-IP8-1	8IP-8	7495-IP15-1	8IP-15
2	0.9610 - 1.3800	1-9/16	1	<b>T-ACR-45-2</b>	T-ACRI-45-B-C5A	7255-IP8-1	8IP-8	7514-IP20-1	8IP-20

### Highlights and Other Information

- Produces a 45° chamfer only
- Clamping screw allows for setting at any length along the flute
- Double effective cutting with face mounted inserts provides increased feed rates and greater insert strength
- The ring is balanced to match the holder center of gravity to ensure stability
- Inserts only available in C5 carbide and TiAlN coating
- Ideal for short-run or time sensitive jobs that require quick delivery



**IMPORTANT:** T-A chamfer rings can only be used with straight flute T-A holders

Inserts sold in quantities of 2  
Screws sold in quantities of 10

## GEN2 T-A Recommended Drilling Data | Imperial (inch)

### HSS Inserts

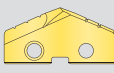
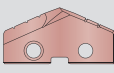
ISO	Material	Hardness (BHN)	HSS Grade	SFM		Feed Rate (IPR) by Diameter	
				 TiN	 AM200®	3/8 - 1/2	33/64 - 11/16
P	Free Machining Steel 1118, 1215, 12L14, etc.	100 - 150	HSS	200	325	0.008	0.012
		150 - 200	HSS	180	300	0.007	0.011
		200 - 250	HSS	160	280	0.006	0.010
	Low Carbon Steel 1010, 1020, 1025, 1522, 1144, etc.	85 - 125	HSS	170	290	0.008 ❖	0.010
		125 - 175	HSS	160	275	0.007 ❖	0.010
		175 - 225	HSS	150	260	0.006 ❖	0.009
	Medium Carbon Steel 1030, 1040, 1050, 1527, 1140, 1151, etc.	225 - 275	HSS	140	240	0.005 ❖	0.009
		125 - 175	HSS	160	275	0.007	0.010
		175 - 225	HSS	150	260	0.006	0.009
	Alloy Steel 4140, 5140, 8640, etc.	225 - 275	HSS	140	240	0.006	0.009
		275 - 325	SC	130	225	0.005	0.008
		325 - 375	SC	110	180	0.004	0.007
225 - 300		SC	80	125	0.006 ❖	0.009	
High Strength Alloy 4340, 4330V, 300M, etc.	300 - 350	SC	60	100	0.005 ❖	0.008	
	350 - 400	SC	50	80	0.004 ❖	0.007	
	100 - 150	HSS	140	235	0.008 ❖	0.011	
Structural Steel A36, A285, A516, etc.	150 - 250	HSS	120	190	0.006 ❖	0.010	
	250 - 350	SC	100	160	0.005 ❖	0.009	
	150 - 200	SC	80	125	0.004	0.007	
Tool Steel H-13, H-21, A-4, O-2, S-3, etc.	200 - 250	SC	60	105	0.004	0.007	
	S	High Temp Alloy Hastelloy B, Inconel 600, etc.	140 - 220	SC	30	45	0.004 ❖
Titanium Alloy		220 - 310	SC	25	40	0.004 ❖	0.006
		140 - 220	SC	35	55	0.004 ❖	0.007
Aerospace Alloy S82		220 - 310	SC	30	50	0.003 ❖	0.006
	185 - 275	SC	75	110	0.006 ❖	0.008	
M	Stainless Steel 400 Series 416, 420, etc.	275 - 350	SC	60	100	0.005 ❖	0.007
		135 - 185	SC	75	110	0.003 ❖	0.007
	Stainless Steel 300 Series 304, 316, 17-4PH, etc.	185 - 275	SC	60	100	0.003 ❖	0.006
		135 - 185	SC	60	85	0.003 ❖	0.007
	Super Duplex Stainless Steel	185 - 275	SC	50	70	0.003 ❖	0.006
H	Wear Plate Hardox, AR400, T-1, etc.	400	SC	45	70	0.003 ❖	0.006
		500	SC	35	45	0.002 ❖	0.005
		600	-	-	-	0.004 ❖	0.006
	Hardened Steel	300 - 400	SC	50	95	-	-
400 - 500		SC	35	45	0.002 ❖	0.005	
K	Nodular, Grey, Ductile Cast Iron	120 - 150	HSS	170	290	0.008	0.012
		150 - 200	HSS	150	260	0.007	0.011
		200 - 220	HSS	130	225	0.006	0.009
		220 - 260	SC	110	190	0.005	0.008
		260 - 320	SC	90	155	0.005	0.007
N	Cast Aluminum	30	HSS	600	-	0.009	0.015
		180	HSS	300	-	0.008	0.013
	Wrought Aluminum	30	HSS	600	900	0.005	0.013
		180	HSS	300	650	0.005	0.007
	Aluminum Bronze	100 - 200	SC	170	270	0.006	0.009
		200 - 250	SC	130	210	0.005	0.007
	Brass	100	HSS	300	470	0.007	0.011
Copper	60	SC	130	190	0.003 ❖	0.004	

❖ Contact our Application Engineering department for assistance when machining these materials

**IMPORTANT:** The speeds and feeds listed above are a general starting point for all applications. Refer to the Coolant Recommendation charts for coolant requirements to run at the recommended speeds and feeds. Factory technical assistance is available through our Application Engineering department. See adjustment examples on the following page.

Feed Rate (IPR) by Diameter				
45/64 - 15/16	31/32 - 1-3/8	1-13/32 - 1-7/8	1-29/32 - 2-9/16	2-19/32 - 4-1/2
0.016	0.019	0.020	0.023	0.028
0.015	0.017	0.020	0.023	0.028
0.014	0.016	0.020	0.023	0.028
0.014	0.018	0.019	0.023	0.027
0.014	0.017	0.019	0.023	0.027
0.013	0.016	0.018	0.021	0.024
0.013	0.016	0.018	0.021	0.024
0.014	0.017	0.019	0.023	0.027
0.013	0.016	0.018	0.021	0.024
0.013	0.016	0.018	0.021	0.024
0.012	0.015	0.016	0.019	0.022
0.014	0.017	0.017	0.019	0.022
0.013	0.016	0.017	0.019	0.022
0.013	0.016	0.017	0.019	0.022
0.012	0.015	0.015	0.017	0.020
0.011	0.014	0.015	0.017	0.020
0.011	0.013	0.014	0.017	0.020
0.010	0.012	0.014	0.017	0.020
0.009	0.011	0.012	0.015	0.018
0.015	0.017	0.018	0.021	0.026
0.013	0.015	0.016	0.019	0.024
0.012	0.013	0.014	0.017	0.020
0.010	0.012	0.012	0.015	0.017
0.010	0.012	0.012	0.015	0.017
0.009	0.011	0.012	0.015	0.017
0.008	0.010	0.010	0.012	0.014
0.008	0.010	0.012	0.015	0.017
0.007	0.009	0.010	0.012	0.014
0.009	0.011	0.014	0.016	0.020
0.008	0.010	0.012	0.014	0.018
0.008	0.011	0.014	0.016	0.020
0.007	0.010	0.012	0.014	0.018
0.008	0.011	0.014	0.016	0.020
0.007	0.010	0.012	0.014	0.018
0.008	0.009	0.012	0.016	0.018
0.007	0.008	0.010	0.012	0.016
0.009	0.011	0.012	0.016	0.018
-	-	-	-	-
0.007	0.009	0.010	0.012	0.016
0.016	0.020	0.024	0.027	0.030
0.015	0.019	0.022	0.025	0.028
0.013	0.017	0.018	0.021	0.024
0.011	0.014	0.014	0.017	0.020
0.010	0.012	0.012	0.014	0.016
0.018	0.023	0.022	0.025	0.025
0.016	0.020	0.022	0.025	0.025
0.016	0.020	0.022	0.025	0.025
0.012	0.014	0.022	0.025	0.025
0.012	0.015	0.017	0.019	0.021
0.009	0.011	0.014	0.016	0.018
0.013	0.018	0.019	0.021	0.023
0.007	0.010	0.009	0.011	0.012

**Deep Hole Drilling Speed and Feed Adjustment**

	Holder Length				
	Extended	Long	Long Plus	XL	3XL
Speed	0.90	0.85	0.80	0.80	0.75
Feed	-	0.95	0.90	0.90	0.90

**Recommended Speed and Feed Example**

If the recommended speed and feed is 200 SFM and 0.008 IPR for a standard length holder, then the speed and feed using a 3XL holder in the same application would be 150 SFM and 0.007 IPR.

$200 \cdot 0.75 = 150 \text{ SFM}$

$0.008 \cdot 0.90 = 0.007 \text{ IPR}$

**Formulas**

- RPM = (3.82 • SFM) / DIA**

where:  
 RPM = revolutions per minute (rev/min)  
 SFM = speed (ft/min)  
 DIA = diameter of drill (inch)
- IPM = RPM • IPR**

where:  
 IPM = inches per minute (in/min)  
 RPM = revolutions per minute (rev/min)  
 IPR = feed rate (in/rev)
- SFM = RPM • 0.262 • DIA**

where:  
 SFM = speed (ft/min)  
 RPM = revolutions per minute (rev/min)  
 DIA = diameter of drill (inch)

**⚠ WARNING Tool failure can cause serious injury. To prevent:**

- When using holders without support bushing, use a short T-A® holder to establish an initial hole that is a minimum of 2 diameters deep.
- Do not rotate tool holder more than 50 RPM unless it is engaged with the workpiece or fixture.

Visit [www.alliedmachine.com/DeepHoleGuidelines](http://www.alliedmachine.com/DeepHoleGuidelines) for the most up-to-date information and procedures. Factory technical assistance is available for your specific applications through our Application Engineering Team.

## GEN2 T-A Recommended Drilling Data | Imperial (inch)

### Carbide Inserts

ISO	Material	Hardness (BHN)	Carbide Grade	SFM  AM300®	Feed Rate (IPR) by Diameter			
					3/8 - 1/2	33/64 - 11/16	45/64 - 15/16	31/32 - 1-3/8
P	Free Machining Steel 1118, 1215, 12L14, etc.	100 - 150	C1	480	0.008	0.012	0.016	0.019
		150 - 200	C1	415	0.007	0.011	0.015	0.017
		200 - 250	C1	390	0.006	0.010	0.014	0.016
	Low Carbon Steel 1010, 1020, 1025, 1522, 1144, etc.	85 - 125	C1	450	0.008 ❖	0.010	0.014	0.018
		125 - 175	C1	390	0.007 ❖	0.010	0.014	0.017
		175 - 225	C1	355	0.006 ❖	0.009	0.013	0.016
		225 - 275	C1	310	0.005 ❖	0.009	0.013	0.016
	Medium Carbon Steel 1030, 1040, 1050, 1527, 1140, 1151, etc.	125 - 175	C1	390	0.007	0.010	0.014	0.017
		175 - 225	C1	355	0.006	0.009	0.013	0.016
		225 - 275	C1	310	0.006	0.009	0.013	0.016
		275 - 325	C1	265	0.005	0.008	0.012	0.015
	Alloy Steel 4140, 5140, 8640, etc.	125 - 175	C1	375	0.007	0.010	0.014	0.017
175 - 225		C1	345	0.006	0.009	0.013	0.016	
225 - 275		C1	310	0.006	0.009	0.013	0.016	
275 - 325		C1	285	0.005	0.008	0.012	0.015	
325 - 375		C1	255	0.004	0.007	0.011	0.014	
High Strength Alloy 4340, 4330V, 300M, etc.	225 - 300	C1	230	0.006 ❖	0.009	0.011	0.013	
	300 - 350	C1	205	0.005 ❖	0.008	0.010	0.012	
	350 - 400	C1	185	0.004 ❖	0.007	0.009	0.011	
Structural Steel A36, A285, A516, etc.	100 - 150	C1	355	0.008 ❖	0.011	0.015	0.017	
	150 - 250	C1	285	0.006 ❖	0.010	0.013	0.015	
	250 - 350	C1	265	0.005 ❖	0.009	0.012	0.013	
Tool Steel H-13, H-21, A-4, O-2, S-3, etc.	150 - 200	C1	255	0.007	0.007	0.010	0.012	
	200 - 250	C1	195	0.007	0.007	0.010	0.012	
S	High Temp Alloy Hastelloy B, Inconel 600, etc.	140 - 220	C2	120	0.004 ❖	0.007	0.009	0.011
		220 - 310	C2	95	0.004 ❖	0.006	0.008	0.010
	Titanium Alloy	140 - 220	C2	140	0.004 ❖	0.007	0.008	0.011
		220 - 310	C2	110	0.003 ❖	0.006	0.007	0.009
	Aerospace Alloy S82	185 - 275	C2	240	0.005 ❖	0.006	0.007	0.009
275 - 350		C2	180	0.004 ❖	0.005	0.006	0.008	
M	Stainless Steel 400 Series 416, 420, etc.	185 - 275	C2	240	0.007 ❖	0.009	0.012	0.014
		275 - 350	C2	180	0.006 ❖	0.008	0.011	0.012
	Stainless Steel 300 Series 304, 316, 17-4PH, etc.	135 - 185	C2	240	0.006 ❖	0.007	0.009	0.012
		185 - 275	C2	180	0.005 ❖	0.006	0.008	0.009
	Super Duplex Stainless Steel	135 - 185	C2	125	0.005 ❖	0.007	0.008	0.010
185 - 275		C2	100	0.004 ❖	0.006	0.007	0.009	

❖ Contact our Application Engineering department for assistance when machining these materials

**IMPORTANT:** The speeds and feeds listed above are a general starting point for all applications. Refer to the Coolant Recommendation charts for coolant requirements to run at the recommended speeds and feeds. Factory technical assistance is available through our Application Engineering department. See adjustment examples on the following page.

ISO	Material	Hardness (BHN)	Carbide Grade	SFM	Feed Rate (IPR) by Diameter			
				 AM300®	3/8 - 1/2	33/64 - 11/16	45/64 - 15/16	31/32 - 1-3/8
H	Wear Plate Hardox, AR400, T-1, etc.	400	C2	150	0.003 ❖	0.005	0.008	0.010
		500	C2	120	0.002 ❖	0.004	0.006	0.008
		600	C2	100	0.001 ❖	0.003	0.005	0.006
	Hardened Steel	300 - 400	C1	150	0.004 ❖	0.006	0.009	0.011
		400 - 500	C1	120	0.003 ❖	0.005	0.008	0.010
K	Nodular, Grey, Ductile Cast Iron	120 - 150	C2	500	0.008	0.012	0.015	0.019
		150 - 200	C2	480	0.007	0.011	0.013	0.017
		200 - 220	C2	430	0.006	0.009	0.012	0.015
		220 - 260	C2	370	0.005	0.008	0.011	0.013
		260 - 320	C2	335	0.005	0.007	0.010	0.011
N	Cast Aluminum	30	C2	975	0.009	0.015	0.018	0.023
		180	C2	730	0.008	0.013	0.016	0.020
	Wrought Aluminum	30	C2	1385	0.005	0.013	0.016	0.020
		180	C2	975	0.005	0.007	0.012	0.014
	Aluminum Bronze	100 - 200	C2	360	0.006	0.009	0.012	0.015
		200 - 250	C2	300	0.005	0.007	0.009	0.011
	Brass	100	C2	650	0.007	0.011	0.013	0.018
Copper	60	C2	420	0.003 ❖	0.004	0.007	0.010	

❖ Contact our Application Engineering department for assistance when machining these materials

**Deep Hole Drilling Speed and Feed Adjustment**

	⚠ Holder Length				
	Extended	Long	Long Plus	XL	3XL
Speed	0.90	0.85	0.80	0.80	0.75
Feed	-	0.95	0.90	0.90	0.90

**Recommended Speed and Feed Example**

If the recommended speed and feed is 200 SFM and 0.008 IPR for a standard length holder, then the speed and feed using a 3XL holder in the same application would be 150 SFM and 0.007 IPR.

$200 \cdot 0.75 = 150 \text{ SFM}$	$0.008 \cdot 0.90 = 0.007 \text{ IPR}$
------------------------------------	--

**Formulas**

1. $RPM = (3.82 \cdot SFM) / DIA$ where: RPM = revolutions per minute (rev/min) SFM = speed (ft/min) DIA = diameter of drill (inch)	2. $IPM = RPM \cdot IPR$ where: IPM = inches per minute (in/min) RPM = revolutions per minute (rev/min) IPR = feed rate (in/rev)	3. $SFM = RPM \cdot 0.262 \cdot DIA$ where: SFM = speed (ft/min) RPM = revolutions per minute (rev/min) DIA = diameter of drill (inch)
---	--	--



**⚠ WARNING** Tool failure can cause serious injury. To prevent:

- When using holders without support bushing, use a short T-A® holder to establish an initial hole that is a minimum of 2 diameters deep.
- Do not rotate tool holder more than 50 RPM unless it is engaged with the workpiece or fixture.

Visit [www.alliedmachine.com/DeepHoleGuidelines](http://www.alliedmachine.com/DeepHoleGuidelines) for the most up-to-date information and procedures. Factory technical assistance is available for your specific applications through our Application Engineering Team.

## Original T-A Recommended Drilling Data | Imperial (inch)

### HSS Inserts

ISO	Material	Hardness (BHN)	HSS Grade	SFM			Feed Rate (IPR) by Diameter	
				 TiN	 TiAlN	 TiCN	3/8 - 1/2	33/64 - 11/16
P	Free Machining Steel 1118, 1215, 12L14, etc.	100 - 150	HSS	200	280	260	0.007	0.010
		150 - 200	HSS	180	260	235	0.007	0.010
		200 - 250	HSS	160	240	210	0.006	0.010
	Low Carbon Steel 1010, 1020, 1025, 1522, 1144, etc.	85 - 125	HSS	170	250	220	0.006 ❖	0.009
		125 - 175	HSS	160	240	210	0.006 ❖	0.009
		175 - 225	HSS	150	225	195	0.005 ❖	0.008
	Medium Carbon Steel 1030, 1040, 1050, 1527, 1140, 1151, etc.	225 - 275	HSS	140	210	180	0.005 ❖	0.008
		125 - 175	HSS	160	240	210	0.006	0.009
		175 - 225	HSS	150	225	195	0.005	0.008
	Alloy Steel 4140, 5140, 8640, etc.	225 - 275	HSS	140	210	180	0.005	0.008
		275 - 325	SC, PC	130	195	170	0.004	0.007
		275 - 325	SC, PC	120	170	155	0.004	0.006
High Strength Alloy 4340, 4330V, 300M, etc.	325 - 375	SC, PC	110	155	145	0.003	0.006	
	225 - 300	SC, PC	80	110	100	0.005 ❖	0.007	
	300 - 350	SC, PC	60	85	80	0.004 ❖	0.007	
Structural Steel A36, A285, A516, etc.	350 - 400	PC	50	70	65	0.003 ❖	0.006	
	100 - 150	HSS	140	200	180	0.006 ❖	0.010	
	150 - 250	HSS	120	170	155	0.005 ❖	0.009	
Tool Steel H-13, H-21, A-4, O-2, S-3, etc.	250 - 350	SC, PC	100	140	130	0.003 ❖	0.008	
	150 - 200	SC	80	110	105	0.004	0.006	
	200 - 250	SC, PC	60	90	85	0.004	0.006	
	S	High Temp Alloy Hastelloy B, Inconel 600, etc.	140 - 220	SC, PC	30	40	35	0.003 ❖
220 - 310			PC	25	35	30	0.003 ❖	0.006
Titanium Alloy		140 - 220	SC, PC	35	50	45	0.003 ❖	0.007
		220 - 310	PC	30	45	35	0.003 ❖	0.006
Aerospace Alloy S82	185 - 275	SC, PC	75	105	95	0.006 ❖	0.008	
	275 - 350	SC, PC	60	90	80	0.005 ❖	0.007	
M	Stainless Steel 400 Series 416, 420, etc.	185 - 275	SC, PC	75	105	95	0.009	0.010
		275 - 350	SC, PC	60	90	80	0.008	0.009
	Stainless Steel 300 Series 304, 316, 17-4PH, etc.	135 - 185	SC, PC	75	105	95	0.007	0.007
		185 - 275	SC, PC	60	90	80	0.006	0.006
	Super Duplex Stainless Steel	135 - 185	SC, PC	60	80	70	0.005	0.005
185 - 275		SC, PC	50	65	60	0.004	0.005	
H	Wear Plate Hardox, AR400, T-1, etc.	400	SC, PC	45	70	55	0.003 ❖	0.006
		500	PC	35	45	40	0.002 ❖	0.005
		600	N/A	-	-	-	-	-
	Hardened Steel	300 - 400	PC	50	95	70	0.003 ❖	0.006
400 - 500		PC	35	45	40	0.002 ❖	0.005	
K	Nodular, Grey, Ductile Cast Iron	120 - 150	HSS	170	250	220	0.007	0.012
		150 - 200	HSS	150	225	195	0.006	0.011
		200 - 220	HSS	130	195	170	0.006	0.009
		220 - 260	SC, PC	110	165	145	0.005	0.007
		260 - 320	SC, PC	90	135	120	0.004	0.006
N	Cast Aluminum	30	HSS	600	850	750	0.008	0.013
		180	HSS	300	450	400	0.008	0.013
	Wrought Aluminum	30	HSS	600	850	750	0.004	0.006
		180	HSS	300	450	400	0.008	0.013
	Aluminum Bronze	100 - 200	SC	170	250	220	0.006	0.011
		200 - 250	SC	130	190	170	0.005	0.007
	Brass	100	HSS	300	445	400	0.007	0.012
Copper	60	SC	130	165	150	0.002 ❖	0.003	

❖ Contact our Application Engineering department for assistance when machining these materials

**IMPORTANT:** The speeds and feeds listed above are a general starting point for all applications. Refer to the Coolant Recommendation charts for coolant requirements to run at the recommended speeds and feeds. Factory technical assistance is available through our Application Engineering department. See adjustment examples on the following page.



Feed Rate (IPR) by Diameter				
45/64 - 15/16	31/32 - 1-3/8	1-13/32 - 1-7/8	1-29/32 - 2-9/16	2-19/32 - 4-1/2
0.013	0.016	0.020	0.023	0.028
0.013	0.016	0.020	0.023	0.028
0.013	0.016	0.020	0.023	0.028
0.012	0.015	0.019	0.023	0.027
0.012	0.015	0.019	0.023	0.027
0.010	0.014	0.018	0.021	0.024
0.010	0.014	0.018	0.021	0.024
0.012	0.015	0.019	0.023	0.027
0.010	0.014	0.018	0.021	0.024
0.010	0.014	0.018	0.021	0.024
0.009	0.012	0.016	0.019	0.022
0.010	0.014	0.017	0.019	0.022
0.010	0.014	0.017	0.019	0.022
0.010	0.014	0.017	0.019	0.022
0.009	0.012	0.015	0.017	0.020
0.009	0.012	0.015	0.017	0.020
0.009	0.010	0.014	0.017	0.020
0.009	0.010	0.014	0.017	0.020
0.008	0.009	0.012	0.015	0.018
0.012	0.014	0.018	0.021	0.026
0.010	0.012	0.016	0.019	0.024
0.009	0.010	0.014	0.017	0.020
0.008	0.010	0.012	0.015	0.017
0.008	0.010	0.012	0.015	0.017
0.008	0.010	0.012	0.015	–
0.007	0.008	0.010	0.012	–
0.008	0.010	0.012	0.015	–
0.007	0.008	0.010	0.012	–
0.009	0.010	0.014	0.016	0.020
0.008	0.008	0.012	0.014	0.018
0.011	0.012	0.013	0.014	0.015
0.010	0.011	0.012	0.013	0.014
0.008	0.008	0.009	0.009	0.010
0.007	0.007	0.008	0.008	0.009
0.006	0.006	0.007	0.008	0.008
0.005	0.006	0.006	0.007	0.007
0.008	0.009	0.012	0.016	0.018
0.007	0.008	0.010	0.012	0.016
–	–	–	–	–
0.008	0.009	0.012	0.016	0.018
0.007	0.008	0.010	0.012	0.016
0.016	0.020	0.024	0.027	0.030
0.014	0.018	0.022	0.025	0.028
0.012	0.016	0.018	0.021	0.024
0.009	0.012	0.014	0.017	0.020
0.007	0.009	0.012	0.014	0.016
0.016	0.020	0.022	0.025	0.025
0.016	0.018	0.022	0.025	0.025
0.010	0.012	0.022	0.025	0.025
0.016	0.018	0.022	0.025	0.025
0.014	0.018	0.022	0.026	0.028
0.009	0.012	0.014	0.017	0.020
0.016	0.020	0.024	0.028	0.030
0.006	0.008	0.012	0.014	0.016

Deep Hole Drilling Speed and Feed Adjustment

	Holder Length				
	Extended	Long	Long Plus	XL	3XL
Speed	0.90	0.85	0.80	0.80	0.75
Feed	–	0.95	0.90	0.90	0.90

Recommended Speed and Feed Example

If the recommended speed and feed is 200 SFM and 0.008 IPR for a standard length holder, then the speed and feed using a 3XL holder in the same application would be 150 SFM and 0.007 IPR.

$200 \cdot 0.75 = 150 \text{ SFM}$

$0.008 \cdot 0.90 = 0.007 \text{ IPR}$

Formulas

- RPM = (3.82 • SFM) / DIA**

where:

  - RPM = revolutions per minute (rev/min)
  - SFM = speed (ft/min)
  - DIA = diameter of drill (inch)
- IPM = RPM • IPR**

where:

  - IPM = inches per minute (in/min)
  - RPM = revolutions per minute (rev/min)
  - IPR = feed rate (in/rev)
- SFM = RPM • 0.262 • DIA**

where:

  - SFM = speed (ft/min)
  - RPM = revolutions per minute (rev/min)
  - DIA = diameter of drill (inch)



**WARNING** Tool failure can cause serious injury. To prevent:

- When using holders without support bushing, use a short T-A® holder to establish an initial hole that is a minimum of 2 diameters deep.
- Do not rotate tool holder more than 50 RPM unless it is engaged with the workpiece or fixture.

Visit [www.alliedmachine.com/DeepHoleGuidelines](http://www.alliedmachine.com/DeepHoleGuidelines) for the most up-to-date information and procedures. Factory technical assistance is available for your specific applications through our Application Engineering Team.



## Original T-A Recommended Drilling Data | Imperial (inch)

### Carbide Inserts

ISO	Material	Hardness (BHN)	Carbide Grade	SFM			Feed Rate (IPR) by Diameter				
				 TiN	 TiAlN	 TiCN	3/8 - 1/2	33/64 - 11/16	45/64 - 15/16	31/32 - 1-3/8	1-13/32 - 1-7/8
P	Free Machining Steel 1118, 1215, 12L14, etc.	100 - 150	C5	320	420	375	0.008	0.012	0.015	0.018	0.021
		150 - 200	C5	280	360	325	0.007	0.011	0.014	0.016	0.019
		200 - 250	C5	260	340	295	0.006	0.010	0.013	0.015	0.017
	Low Carbon Steel 1010, 1020, 1025, 1522, 1144, etc.	85 - 125	C5	300	390	360	0.008 ❖	0.010	0.013	0.017	0.019
		125 - 175	C5	260	340	295	0.007 ❖	0.010	0.013	0.016	0.018
		175 - 225	C5	240	310	270	0.006 ❖	0.009	0.012	0.015	0.017
	Medium Carbon Steel 1030, 1040, 1050, 1527, 1140, 1151, etc.	125 - 175	C5	260	340	295	0.007	0.010	0.013	0.016	0.018
		175 - 225	C5	240	310	275	0.006	0.009	0.012	0.015	0.017
		225 - 275	C5	210	270	235	0.006	0.009	0.012	0.015	0.017
	Alloy Steel 4140, 5140, 8640, etc.	275 - 325	C5	180	230	205	0.005	0.008	0.011	0.014	0.016
		125 - 175	C5	250	325	285	0.007	0.010	0.013	0.016	0.018
		175 - 225	C5	230	300	260	0.006	0.009	0.012	0.015	0.017
225 - 275		C5	210	270	235	0.006	0.009	0.012	0.015	0.017	
275 - 325		C5	200	250	225	0.005	0.008	0.011	0.014	0.016	
High Strength Alloy 4340, 4330V, 300M, etc.	325 - 375	C5	170	220	195	0.004	0.007	0.010	0.013	0.015	
	225 - 300	C5	160	200	180	0.006 ❖	0.009	0.010	0.012	0.015	
	300 - 350	C5	140	180	160	0.005 ❖	0.008	0.009	0.011	0.014	
Structural Steel A36, A285, A516, etc.	350 - 400	C5	120	160	140	0.004 ❖	0.007	0.008	0.010	0.012	
	100 - 150	C5	240	310	275	0.008 ❖	0.011	0.014	0.016	0.018	
	150 - 250	C5	200	250	225	0.006 ❖	0.010	0.012	0.014	0.016	
Tool Steel H-13, H-21, A-4, O-2, S-3, etc.	250 - 350	C5	180	230	205	0.005 ❖	0.009	0.011	0.012	0.014	
	150 - 200	C5	160	220	190	0.004	0.007	0.009	0.011	0.013	
200 - 250	C5	120	170	145	0.004	0.007	0.009	0.011	0.013		
	S	High Temp Alloy Hastelloy B, Inconel 600, etc.	140 - 220	C2	80	105	90	0.004 ❖	0.007	0.009	0.011
220 - 310		C2	60	85	70	0.004 ❖	0.006	0.008	0.010	0.012	
Titanium Alloy		140 - 220	C2	100	125	105	0.004 ❖	0.007	0.009	0.011	0.013
		220 - 310	C2	80	110	90	0.004 ❖	0.006	0.008	0.010	0.012
Aerospace Alloy S82		185 - 275	C2	160	210	185	0.007 ❖	0.006	0.011	0.014	0.016
	275 - 350	C2	120	160	140	0.006 ❖	0.008	0.010	0.012	0.014	
M	Stainless Steel 400 Series 416, 420, etc.	185 - 275	C2	160	210	185	0.007 ❖	0.008	0.011	0.014	0.016
		275 - 350	C2	120	160	140	0.006 ❖	0.007	0.010	0.012	0.014
	Stainless Steel 300 Series 304, 316, 17-4PH, etc.	135 - 185	C2	160	210	185	0.005 ❖	0.007	0.009	0.010	0.012
		185 - 275	C2	120	160	140	0.004 ❖	0.006	0.008	0.009	0.010
	Super Duplex Stainless Steel	135 - 185	C2	80	110	95	0.004 ❖	0.007	0.008	0.009	0.011
185 - 275		C2	60	80	70	0.003 ❖	0.006	0.007	0.008	0.009	

❖ Contact our Application Engineering department for assistance when machining these materials

**IMPORTANT:** The speeds and feeds listed above are a general starting point for all applications. Refer to the Coolant Recommendation charts for coolant requirements to run at the recommended speeds and feeds. Factory technical assistance is available through our Application Engineering department. See adjustment examples on the following page.

ISO	Material	Hardness (BHN)	Carbide Grade	SFM			Feed Rate (IPR) by Diameter				
				 TiN	 TiAlN	 TiCN	3/8 - 1/2	33/64 - 11/16	45/64 - 15/16	31/32 - 1-3/8	1-13/32 - 1-7/8
H	Wear Plate Hardox, AR400, T-1, etc.	400	C5	75	115	100	0.003 ❖	0.006	0.008	0.010	0.012
		500	C5	50	85	70	0.002 ❖	0.005	0.006	0.008	0.010
		600	C5	35	75	55	0.001 ❖	0.004	0.005	0.006	0.008
	Hardened Steel	300 - 400	C5	110	140	130	0.004 ❖	0.006	0.009	0.011	0.013
400 - 500		C5	65	85	75	0.003 ❖	0.005	0.008	0.009	0.011	
K	Nodular, Grey, Ductile Cast Iron	120 - 150	C2, C3	320	460	415	0.008	0.012	0.015	0.019	0.023
		150 - 200	C2, C3	270	400	335	0.007	0.011	0.013	0.017	0.021
		200 - 220	C2, C3	240	360	305	0.006	0.009	0.012	0.015	0.018
		220 - 260	C2, C3	210	310	260	0.005	0.008	0.011	0.013	0.015
		260 - 320	C2, C3	180	270	225	0.005	0.007	0.010	0.011	0.013
N	Cast Aluminum	30	C2	1200	1500	1330	0.010	0.013	0.018	0.020	0.022
		180	C2	800	1000	900	0.009	0.013	0.016	0.018	0.020
	Wrought Aluminum	30	C2	1200	1500	1330	0.004	0.006	0.010	0.012	0.014
		180	C2	800	1000	900	0.008	0.013	0.014	0.018	0.020
	Aluminum Bronze	100 - 200	C2	275	360	325	0.005	0.008	0.010	0.014	0.017
		200 - 250	C2	210	305	260	0.004	0.007	0.007	0.010	0.013
	Brass	100	C2	425	600	520	0.006	0.009	0.011	0.015	0.018
Copper	60	C2	260	390	325	0.002 ❖	0.003	0.004	0.006	0.010	

❖ Contact our Application Engineering department for assistance when machining these materials

**Deep Hole Drilling Speed and Feed Adjustment**

	⚠ Holder Length				
	Extended	Long	Long Plus	XL	3XL
Speed	0.90	0.85	0.80	0.80	0.75
Feed	-	0.95	0.90	0.90	0.90

**Recommended Speed and Feed Example**

If the recommended speed and feed is 200 SFM and 0.008 IPR for a standard length holder, then the speed and feed using a 3XL holder in the same application would be 150 SFM and 0.007 IPR.

$200 \cdot 0.75 = 150 \text{ SFM}$	$0.008 \cdot 0.90 = 0.007 \text{ IPR}$
------------------------------------	--

**Formulas**

1. $RPM = (3.82 \cdot SFM) / DIA$ where: RPM = revolutions per minute (rev/min) SFM = speed (ft/min) DIA = diameter of drill (inch)	2. $IPM = RPM \cdot IPR$ where: IPM = inches per minute (in/min) RPM = revolutions per minute (rev/min) IPR = feed rate (in/rev)	3. $SFM = RPM \cdot 0.262 \cdot DIA$ where: SFM = speed (ft/min) RPM = revolutions per minute (rev/min) DIA = diameter of drill (inch)
---	--	--

**⚠ WARNING** Tool failure can cause serious injury. To prevent:





- When using holders without support bushing, use a short T-A® holder to establish an initial hole that is a minimum of 2 diameters deep.
- Do not rotate tool holder more than 50 RPM unless it is engaged with the workpiece or fixture.

Visit [www.alliedmachine.com/DeepHoleGuidelines](http://www.alliedmachine.com/DeepHoleGuidelines) for the most up-to-date information and procedures. Factory technical assistance is available for your specific applications through our Application Engineering Team.

A  
DRILLING  
B  
BORING  
C  
REAMING  
D  
BURNISHING  
E  
THREADING  
X  
SPECIALS

## Original T-A Recommended Drilling Data | Imperial (inch)

HSS Inserts | Flat Bottom Geometry

ISO	Material	Hardness (BHN)	HSS Grade	SFM			
				 TiN	 TiAlN	 TiCN	 AM200®
P	Free Machining Steel 1118, 1215, 12L14, etc.	100 - 150	HSS	170	250	230	290
		150 - 200	HSS	155	230	205	265
		200 - 250	HSS	140	210	185	245
	Low Carbon Steel 1010, 1020, 1025, 1522, 1144, etc.	85 - 125	HSS	150	220	195	255
		125 - 175	HSS	140	210	185	245
		175 - 225	HSS	130	195	175	225
		225 - 275	HSS	120	185	155	215
	Medium Carbon Steel 1030, 1040, 1050, 1527, 1140, 1151, etc.	125 - 175	HSS	140	210	185	245
		175 - 225	HSS	130	195	175	225
		225 - 275	HSS	120	185	155	215
		275 - 325	SC	110	175	150	205
	Alloy Steel 4140, 5140, 8640, etc.	125 - 175	HSS	130	185	175	215
175 - 225		HSS	120	175	155	205	
225 - 275		HSS	110	155	145	180	
275 - 325		SC	105	145	135	170	
High Strength Alloy 4340, 4330V, 300M, etc.	225 - 300	SC	70	95	85	110	
	300 - 350	SC	50	75	70	90	
	350 - 400	SC	45	65	60	75	
Structural Steel A36, A285, A516, etc.	100 - 150	HSS	120	170	155	195	
	150 - 250	HSS	105	145	135	170	
	250 - 350	SC	85	120	110	140	
Tool Steel H-13, H-21, A-4, O-2, S-3, etc.	150 - 200	SC	70	95	90	110	
	200 - 250	SC	50	80	75	95	
S	High Temp Alloy Hastelloy B, Inconel 600, etc.	140 - 220	SC	25	35	30	40
		220 - 310	SC	20	30	25	35
	Titanium Alloy	140 - 220	SC	35	45	40	50
		220 - 310	SC	26	40	35	45
Aerospace Alloy S82	185 - 275	SC	65	90	85	110	
	275 - 350	SC	50	80	70	90	
M	Stainless Steel 400 Series 416, 420, etc.	185 - 275	SC	65	90	85	110
		275 - 350	SC	50	80	70	90
	Stainless Steel 300 Series 304, 316, 17-4PH, etc.	135 - 185	SC	65	90	85	110
		185 - 275	SC	50	80	70	90
	Super Duplex Stainless Steel	135 - 185	SC	65	90	85	110
185 - 275		SC	50	80	70	90	
H	Wear Plate Hardox, AR400, T-1, etc.	400	SC	-	-	-	-
		500	SC	-	-	-	-
		600	N/A	-	-	-	-
	Hardened Steel	300 - 400	SC	45	65	60	80
400 - 500		SC	25	40	35	45	
K	Nodular, Grey, Ductile Cast Iron	120 - 150	HSS	150	220	195	255
		150 - 200	HSS	130	195	175	225
		200 - 220	HSS	110	175	150	205
		220 - 260	SC	95	150	125	175
		260 - 320	SC	80	120	105	140
N	Cast Aluminum	30	HSS	520	750	650	-
		180	HSS	260	400	350	-
	Wrought Aluminum	30	HSS	520	750	650	850
		180	HSS	260	400	350	450
	Aluminum Bronze	100 - 200	SC	130	190	175	230
		200 - 250	SC	95	150	125	165
Brass	100	HSS	150	220	190	250	
Copper	60	SC	115	150	130	170	

❖ Contact our Application Engineering department for assistance when machining these materials

**IMPORTANT:** The speeds and feeds listed above are a general starting point for all applications. Refer to the Coolant Recommendation charts for coolant requirements to run at the recommended speeds and feeds. Factory technical assistance is available through our Application Engineering department. See adjustment examples on the following page.

Feed Rate (IPR) by Diameter					
3/8 - 1/2	33/64 - 11/16	45/64 - 15/16	31/32 - 1-3/8	1-13/32 - 1-7/8	1-29/32 - 2-9/16
0.006	0.009	0.011	0.014	0.016	0.018
0.006	0.009	0.011	0.014	0.016	0.018
0.005	0.009	0.011	0.014	0.015	0.017
0.005 ❖	0.008	0.010	0.013	0.015	0.017
0.005 ❖	0.008	0.010	0.013	0.015	0.016
0.004 ❖	0.007	0.009	0.012	0.014	0.016
0.004 ❖	0.007	0.009	0.012	0.014	0.015
0.005	0.008	0.010	0.013	0.015	0.018
0.004	0.007	0.009	0.012	0.014	0.017
0.004	0.007	0.009	0.012	0.014	0.017
0.004	0.006	0.008	0.010	0.013	0.015
0.005	0.007	0.009	0.012	0.013	0.016
0.004	0.007	0.009	0.012	0.013	0.016
0.004	0.006	0.009	0.012	0.013	0.016
0.004	0.005	0.008	0.010	0.012	0.015
0.003	0.005	0.008	0.010	0.012	0.014
0.004 ❖	0.006	0.008	0.009	0.010	0.012
0.003 ❖	0.006	0.008	0.009	0.010	0.012
0.003 ❖	0.005	0.007	0.008	0.009	0.011
0.005 ❖	0.009	0.010	0.012	0.015	0.017
0.004 ❖	0.008	0.009	0.010	0.013	0.016
0.004 ❖	0.007	0.008	0.009	0.012	0.015
0.004	0.005	0.007	0.009	0.010	0.012
0.004	0.005	0.007	0.009	0.009	0.011
0.003 ❖	0.006	0.007	0.009	0.010	0.012
0.003 ❖	0.005	0.006	0.007	0.008	0.010
0.003 ❖	0.006	0.007	0.009	0.010	0.012
0.003 ❖	0.005	0.006	0.007	0.008	0.010
0.005 ❖	0.007	0.008	0.010	0.012	0.015
0.004 ❖	0.006	0.007	0.009	0.010	0.012
0.005 ❖	0.007	0.008	0.010	0.012	0.014
0.004 ❖	0.006	0.007	0.009	0.010	0.011
0.005 ❖	0.007	0.008	0.010	0.012	0.014
0.004 ❖	0.006	0.007	0.009	0.010	0.011
-	-	-	-	-	-
-	-	-	-	-	-
-	-	-	-	-	-
0.003 ❖	0.005	0.007	0.008	0.011	0.015
0.002 ❖	0.004	0.006	0.007	0.009	0.011
0.007	0.012	0.016	0.020	0.024	0.027
0.006	0.011	0.014	0.018	0.022	0.025
0.006	0.009	0.012	0.016	0.018	0.021
0.005	0.007	0.009	0.012	0.014	0.017
0.004	0.006	0.007	0.009	0.012	0.014
0.007	0.011	0.014	0.017	0.018	0.019
0.007	0.011	0.014	0.016	0.017	0.019
0.007	0.011	0.014	0.017	0.018	0.019
0.007	0.011	0.014	0.016	0.017	0.019
0.005	0.009	0.012	0.016	0.020	0.024
0.004	0.006	0.008	0.010	0.012	0.015
0.006	0.010	0.014	0.017	0.021	0.025
0.002 ❖	0.003	0.006	0.008	0.010	0.014

Deep Hole Drilling Speed and Feed Adjustment

	Holder Length				
	Extended	Long	Long Plus	XL	3XL
Speed	0.90	0.85	0.80	0.80	0.75
Feed	-	0.95	0.90	0.90	0.90

Recommended Speed and Feed Example

If the recommended speed and feed is 200 SFM and 0.008 IPR for a standard length holder, then the speed and feed using a 3XL holder in the same application would be 150 SFM and 0.007 IPR.

$200 \cdot 0.75 = 150 \text{ SFM}$

$0.008 \cdot 0.90 = 0.007 \text{ IPR}$

Formulas

- RPM = (3.82 • SFM) / DIA**

where:

  - RPM = revolutions per minute (rev/min)
  - SFM = speed (ft/min)
  - DIA = diameter of drill (inch)
- IPM = RPM • IPR**

where:

  - IPM = inches per minute (in/min)
  - RPM = revolutions per minute (rev/min)
  - IPR = feed rate (in/rev)
- SFM = RPM • 0.262 • DIA**

where:

  - SFM = speed (ft/min)
  - RPM = revolutions per minute (rev/min)
  - DIA = diameter of drill (inch)





**⚠ WARNING** Tool failure can cause serious injury. To prevent:

- When using holders without support bushing, use a short T-A® holder to establish an initial hole that is a minimum of 2 diameters deep.
- Do not rotate tool holder more than 50 RPM unless it is engaged with the workpiece or fixture.

Visit [www.alliedmachine.com/DeepHoleGuidelines](http://www.alliedmachine.com/DeepHoleGuidelines) for the most up-to-date information and procedures. Factory technical assistance is available for your specific applications through our Application Engineering Team.





## Original T-A Recommended Drilling Data | Imperial (inch)

Carbide Inserts | Flat Bottom Geometry

ISO	Material	Hardness (BHN)	Carbide Grade	SFM				Feed Rate (IPR) by Diameter			
				 TiN	 TiAlN	 TiCN	 AM200®	3/8 - 1/2	33/64 - 11/16	45/64 - 15/16	13/32 - 1-7/8
P	Free Machining Steel 1118, 1215, 12L14, etc.	100 - 150	C2	270	380	325	425	0.007	0.010	0.013	0.015
		150 - 200	C2	240	320	280	375	0.006	0.009	0.012	0.014
		200 - 250	C2	220	300	260	350	0.005	0.009	0.011	0.013
	Low Carbon Steel 1010, 1020, 1025, 1522, 1144, etc.	85 - 125	C2	260	345	315	410	0.007 ❖	0.009	0.011	0.014
		125 - 175	C2	220	300	260	350	0.006 ❖	0.009	0.011	0.014
		175 - 225	C2	200	280	235	320	0.005 ❖	0.008	0.010	0.013
	Medium Carbon Steel 1030, 1040, 1050, 1527, 1140, 1151, etc.	125 - 175	C2	220	300	260	350	0.006	0.009	0.011	0.014
		175 - 225	C2	200	280	240	320	0.005	0.008	0.010	0.013
		225 - 275	C2	180	240	215	285	0.004 ❖	0.008	0.010	0.013
	Alloy Steel 4140, 5140, 8640, etc.	275 - 325	C2	150	210	180	240	0.004	0.007	0.009	0.012
		125 - 175	C2	215	290	250	340	0.006	0.009	0.011	0.014
		175 - 225	C2	200	270	230	320	0.005	0.008	0.010	0.013
225 - 275		C2	180	230	205	290	0.005	0.008	0.010	0.013	
275 - 325		C2	175	215	190	280	0.004	0.007	0.009	0.012	
High Strength Alloy 4340, 4330V, 300M, etc.	325 - 375	C2	145	190	170	230	0.003	0.006	0.009	0.011	
	225 - 300	C2	140	170	160	220	0.005 ❖	0.008	0.009	0.010	
	300 - 350	C2	120	160	140	190	0.004 ❖	0.007	0.008	0.009	
Structural Steel A36, A285, A516, etc.	350 - 400	C2	100	145	120	160	0.003 ❖	0.006	0.007	0.009	
	100 - 150	C2	205	265	240	325	0.007 ❖	0.009	0.012	0.014	
	150 - 250	C2	170	215	200	270	0.005 ❖	0.009	0.010	0.012	
Tool Steel H-13, H-21, A-4, O-2, S-3, etc.	250 - 350	C2	155	200	180	240	0.004 ❖	0.008	0.009	0.010	
	150 - 200	C2	140	190	160	220	0.003	0.006	0.008	0.009	
200 - 250	C2	100	150	120	160	0.003	0.006	0.008	0.009		
	S	High Temp Alloy Hastelloy B, Inconel 600, etc.	140 - 220	C2	70	90	80	110	0.003 ❖	0.006	0.008
Titanium Alloy		220 - 310	C2	50	70	60	80	0.003 ❖	0.005	0.007	0.009
		140 - 220	C2	85	110	90	130	0.003 ❖	0.005	0.006	0.008
Aerospace Alloy S82		220 - 310	C2	70	95	80	100	0.003 ❖	0.004	0.005	0.007
	185 - 275	C2	140	120	165	130	0.006 ❖	0.006	0.010	0.012	
275 - 350	C2	110	90	125	105	0.005 ❖	0.005	0.009	0.010		
	M	Stainless Steel 400 Series 416, 420, etc.	185 - 275	C2	140	180	165	210	0.006 ❖	0.008	0.010
275 - 350			C2	110	140	125	160	0.005 ❖	0.007	0.009	0.010
Stainless Steel 300 Series 304, 316, 17-4PH, etc.		135 - 185	C2	90	120	110	130	0.005 ❖	0.007	0.008	0.010
		185 - 275	C2	70	90	80	105	0.004 ❖	0.006	0.007	0.009
Super Duplex Stainless Steel		135 - 185	C2	70	95	85	110	0.004 ❖	0.006	0.007	0.008
	185 - 275	C2	55	70	60	85	0.003 ❖	0.005	0.006	0.007	

❖ Contact our Application Engineering department for assistance when machining these materials

**IMPORTANT:** The speeds and feeds listed above are a general starting point for all applications. Refer to the Coolant Recommendation charts for coolant requirements to run at the recommended speeds and feeds. Factory technical assistance is available through our Application Engineering department. See adjustment examples on the following page.

ISO	Material	Hardness (BHN)	Carbide Grade	SFM				Feed Rate (IPR) by Diameter			
				 TiN	 TiAlN	 TiCN	 AM200®	3/8 - 1/2	33/64 - 11/16	45/64 - 15/16	13/32 - 1-7/8
H	Wear Plate Hardox, AR400, T-1, etc.	400	C2	65	100	85	130	0.003 ❖	0.004	0.006	0.008
		500	C2	45	75	60	100	0.002 ❖	0.003	0.005	0.006
		600	C2	35	65	45	80	0.001 ❖	0.002	0.004	0.005
	Hardened Steel	300 - 400	C2	100	125	110	135	0.004 ❖	0.006	0.007	0.009
400 - 500		C2	60	75	65	110	0.003 ❖	0.005	0.006	0.007	
K	Nodular, Grey, Ductile Cast Iron	120 - 150	C2	270	405	360	450	0.007	0.010	0.013	0.016
		150 - 200	C2	230	350	290	390	0.006	0.009	0.011	0.014
		200 - 220	C2	200	320	260	350	0.005	0.008	0.010	0.013
		220 - 260	C2	180	270	220	300	0.004	0.007	0.009	0.011
		260 - 320	C2	160	240	200	265	0.004	0.006	0.009	0.009
N	Cast Aluminum	30	C2	520	750	650	-	0.009	0.013	0.016	0.017
		180	C2	260	400	350	-	0.008	0.012	0.014	0.015
	Wrought Aluminum	30	C2	950	1200	1070	1270	0.005	0.007	0.009	0.010
		180	C2	630	800	715	850	0.004	0.006	0.008	0.009
	Aluminum Bronze	100 - 200	C2	240	310	280	340	0.004	0.006	0.008	0.011
		200 - 250	C2	180	265	220	285	0.003	0.005	0.006	0.008
	Brass	100	C2	370	520	450	600	0.005	0.006	0.008	0.012
Copper	60	C2	220	345	280	380	0.002 ❖	0.002	0.003	0.005	

❖ Contact our Application Engineering department for assistance when machining these materials

**Deep Hole Drilling Speed and Feed Adjustment**

	⚠ Holder Length				
	Extended	Long	Long Plus	XL	3XL
Speed	0.90	0.85	0.80	0.80	0.75
Feed	-	0.95	0.90	0.90	0.90

**Recommended Speed and Feed Example**

If the recommended speed and feed is 200 SFM and 0.008 IPR for a standard length holder, then the speed and feed using a 3XL holder in the same application would be 150 SFM and 0.007 IPR.

$200 \cdot 0.75 = 150 \text{ SFM}$	$0.008 \cdot 0.90 = 0.007 \text{ IPR}$
------------------------------------	--

**Formulas**

<p>1. <math>RPM = (3.82 \cdot SFM) / DIA</math></p> <p>where:</p> <ul style="list-style-type: none"> <li>RPM = revolutions per minute (rev/min)</li> <li>SFM = speed (ft/min)</li> <li>DIA = diameter of drill (inch)</li> </ul>	<p>2. <math>IPM = RPM \cdot IPR</math></p> <p>where:</p> <ul style="list-style-type: none"> <li>IPM = inches per minute (in/min)</li> <li>RPM = revolutions per minute (rev/min)</li> <li>IPR = feed rate (in/rev)</li> </ul>	<p>3. <math>SFM = RPM \cdot 0.262 \cdot DIA</math></p> <p>where:</p> <ul style="list-style-type: none"> <li>SFM = speed (ft/min)</li> <li>RPM = revolutions per minute (rev/min)</li> <li>DIA = diameter of drill (inch)</li> </ul>
--	---	---

**⚠ WARNING** Tool failure can cause serious injury. To prevent:

- When using holders without support bushing, use a short T-A® holder to establish an initial hole that is a minimum of 2 diameters deep.
- Do not rotate tool holder more than 50 RPM unless it is engaged with the workpiece or fixture.

Visit [www.alliedmachine.com/DeepHoleGuidelines](http://www.alliedmachine.com/DeepHoleGuidelines) for the most up-to-date information and procedures. Factory technical assistance is available for your specific applications through our Application Engineering Team.

A  
DRILLING  
B  
BORING  
C  
REAMING  
D  
BURNISHING  
E  
THREADING  
X  
SPECIALS

## Original T-A Recommended Drilling Data | Imperial (inch)

Carbide Inserts | Diamond Coating

Material	Carbide Grade	SFM  Diamond Coating	Feed Rate (IPR) by Diameter				
			3/8 - 1/2	33/64 - 11/16	45/64 - 15/16	31/32 - 1-3/8	
Polymer Matrix Composites	Carbon (hard)	N2	1000 - 1500	0.004 - 0.006	0.008 - 0.010	0.010 - 0.012	0.012 - 0.014
	Carbon Fiber	N2	1000 - 1500	0.004 - 0.006	0.008 - 0.010	0.010 - 0.012	0.012 - 0.014
	Carbon / Glass Fiber	N2	1000 - 1500	0.004 - 0.006	0.008 - 0.010	0.010 - 0.012	0.012 - 0.014
	Fiberglass	N2	1000 - 1500	0.004 - 0.006	0.008 - 0.010	0.010 - 0.012	0.012 - 0.014
	Graphite	N2	1000 - 1500	0.004 - 0.006	0.008 - 0.010	0.010 - 0.012	0.012 - 0.014
	Plastics	N2	250 - 1000	0.004 - 0.006	0.008 - 0.010	0.010 - 0.012	0.012 - 0.014
	Epoxy Resin	N2	250 - 1000	0.004 - 0.006	0.008 - 0.010	0.010 - 0.012	0.012 - 0.014
	Bismaleimide Resin	N2	250 - 1000	0.004 - 0.006	0.008 - 0.010	0.010 - 0.012	0.012 - 0.014
	Polyester Resin	N2	250 - 1000	0.004 - 0.006	0.008 - 0.010	0.010 - 0.012	0.012 - 0.014
	Phenolic Resin	N2	250 - 1000	0.004 - 0.006	0.008 - 0.010	0.010 - 0.012	0.012 - 0.014
Rubber	N2	250 - 1000	0.004 - 0.006	0.008 - 0.010	0.010 - 0.012	0.012 - 0.014	
Metal Matrix Composites	Aluminum	N2	1000	0.008	0.013	0.016	0.020
	Si < 10%	N2	1000	0.008	0.013	0.016	0.020
	10% < Si < 15%	N2	850 - 1000	0.008	0.013	0.016	0.020
	15% < Si < 20%	N2	650 - 850	0.008	0.013	0.016	0.020
	20% < Si < 25%	N2	500 - 650	0.008	0.013	0.016	0.020
	25% < Si	N2	200 - 500	0.008	0.013	0.016	0.020
	Brass	N2	250 - 500	0.008	0.013	0.016	0.020
	Bronze	N2	250 - 500	0.008	0.013	0.016	0.020
	Copper	N2	100 - 250	0.004 - 0.006	0.008 - 0.010	0.010 - 0.012	0.012 - 0.014
	Copper Alloys	N2	100 - 250	0.004 - 0.006	0.008 - 0.010	0.010 - 0.012	0.012 - 0.014
	Lead Alloys	N2	100 - 250	0.004 - 0.006	0.008 - 0.010	0.010 - 0.012	0.012 - 0.014
	Magnesium Alloys	N2	100 - 250	0.004 - 0.006	0.008 - 0.010	0.010 - 0.012	0.012 - 0.014
	Precious Metals	N2	100 - 250	0.004 - 0.006	0.008 - 0.010	0.010 - 0.012	0.012 - 0.014
Ceramic Matrix Composites	Carbide (green)	N2	50 - 250	0.004 - 0.006	0.008 - 0.010	0.010 - 0.012	0.012 - 0.014
	Ceramic (green)	N2	50 - 250	0.004 - 0.006	0.008 - 0.010	0.010 - 0.012	0.012 - 0.014
	Ceramic (pre-sintered)	N2	50 - 250	0.004 - 0.006	0.008 - 0.010	0.010 - 0.012	0.012 - 0.014

### Deep Hole Drilling Speed and Feed Adjustment

	Holder Length				
	Extended	Long	Long Plus	XL	3XL
Speed	0.90	0.85	0.80	0.80	0.75
Feed	-	0.95	0.90	0.90	0.90

### Recommended Speed and Feed Example

If the recommended speed and feed is 200 SFM and 0.008 IPR for a standard length holder, then the speed and feed using a 3XL holder in the same application would be 150 SFM and 0.007 IPR.

$$200 \cdot 0.75 = 150 \text{ SFM}$$

$$0.008 \cdot 0.90 = 0.007 \text{ IPR}$$

#### **WARNING** Tool failure can cause serious injury. To prevent:

- When using holders without support bushing, use a short T-A® holder to establish an initial hole that is a minimum of 2 diameters deep.
- Do not rotate tool holder more than 50 RPM unless it is engaged with the workpiece or fixture.

Visit [www.alliedmachine.com/DeepHoleGuidelines](http://www.alliedmachine.com/DeepHoleGuidelines) for the most up-to-date information and procedures. Factory technical assistance is available for your specific applications through our Application Engineering Team.

**IMPORTANT:** The speeds and feeds listed above are a general starting point for all applications. Refer to the Coolant Recommendation charts for coolant requirements to run at the recommended speeds and feeds. Factory technical assistance is available through our Application Engineering department. See adjustment examples on the following page.



## Tap Drill Information and Formulas | Imperial (inch)

### American - Unified Inch Screw Thread

Tap Size	Tap Drill Size	Decimal Equivalent	* Theo % Thread	Probable Mean Oversize	Probable Hole Size	** Probable % Thread
7/16 - 20	W	0.3860	79%	0.003"	0.3890"	75%
7/16 - 20	25/64"	0.3906	72%	0.003"	0.3936"	68%
1/2 - 13	10.5mm	0.4134	87%	0.003"	0.4164"	84%
1/2 - 13	27/64"	0.4219	78%	0.003"	0.4249"	75%
1/2 - 13	7/16"	0.4375	63%	0.003"	0.4405"	60%
1/2 - 20	29/64"	0.4531	72%	0.003"	0.4561"	68%
9/16 - 12	15/32"	0.4688	87%	0.003"	0.4718"	84%
9/16 - 12	12.0mm	0.4724	72%	0.003"	0.4874"	69%
9/16 - 12	31/64"	0.4844	83%	0.003"	0.4754"	80%
9/16 - 18	1/2"	0.5000"	87%	0.003"	0.5030"	82%
9/16 - 18	13.0mm	0.5118"	70%	0.003"	0.5148"	66%
9/16 - 18	31/64"	0.5156"	65%	0.003"	0.5186"	61%
5/8 - 11	17/32"	0.5313"	79%	0.003"	0.5343"	77%
5/8 - 12	35/64"	0.5469"	72%	0.003"	0.5499"	69%
5/8 - 18	9/16"	0.5625"	87%	0.003"	0.5655"	82%
5/8 - 18	14.5mm	0.5709"	75%	0.003"	0.5739"	75%
5/8 - 18	37/64"	0.5781"	65%	0.003"	0.5811"	70%
11/16 - 12	39/64"	0.6094"	72%	0.003"	0.6124"	69%
3/4 - 10	41/64"	0.6406"	84%	0.003"	0.6436"	82%
3/4 - 10	16.5mm	0.6496"	77%	0.003"	0.6526"	75%
3/4 - 10	21/32"	0.6563"	72%	0.003"	0.6593"	70%
3/4 - 12	43/64"	0.6719"	72%	0.003"	0.6749"	69%
3/4 - 16	11/16"	0.6875"	77%	0.003"	0.6905"	73%
3/4 - 16	17.5mm	0.6890"	75%	0.003"	0.6920"	71%
7/8 - 9	49/64"	0.7656"	76%	0.003"	0.7686"	74%
7/8 - 9	25/32"	0.7813"	65%	0.003"	0.7843"	63%
7/8 - 14	51/64"	0.7969"	84%	0.003"	0.7999"	81%
7/8 - 14	13/16"	0.8125"	67%	0.003"	0.8155"	64%
15/16 - 12	55/64"	0.8594"	72%	0.003"	0.8624"	69%
15/16 - 20	57/64"	0.8906"	72%	0.003"	0.8936"	68%
1 - 8	22.0mm	0.8661"	82%	0.003"	0.8691"	81%
1 - 8	7/8"	0.8750"	77%	0.003"	0.8780"	75%
1 - 8	57/64"	0.8906"	67%	0.003"	0.8936"	65%
1 - 12	29/32"	0.9063"	87%	0.003"	0.9093"	84%
1 - 12	59/64"	0.9219"	72%	0.003"	0.9249"	69%
1 - 14	15/16"	0.9375"	67%	0.003"	0.9405"	64%
1-1/8 - 12	1-1/32"	1.0313"	87%	0.003"	1.0343"	84%
1-1/8 - 12	1-3/64"	1.0469"	72%	0.003"	1.0499"	69%
1-1/4 - 7	1-7/64"	1.1094"	76%	0.003"	1.1124"	74%
24 x 2	7/8"	0.8750"	68%	0.075mm	22.30mm	65%
27 x 3	24.0mm	0.9449"	77%	0.075mm	24.08mm	75%

### Taper Pipe Thread (NPT)

Tap Size	Tap Drill Size	Decimal Equivalent	Theo % Thread*	Probable Mean Oversize	Probable Hole Size	Probable % Thread**
1/4 - 18	7/16	0.4375	-	0.003	0.4405	-
3/8 - 18	9/16	0.5625	-	0.003	0.5655	-
1/2 - 14	45/64	0.7031	-	0.003	0.7061	-
3/4 - 14	29/32	0.9063	-	0.003	0.9093	-

\* Based on nominal tap drill diameter

\*\* Based on .003" probable mean oversize

To calculate the percent of full thread for a given hole diameter:

$$\% \text{ Thread} = \# \text{ of Thread per Inch} \left[ \frac{\text{Basic Major Diameter of Thread} - \text{Drill Hole Size}}{0.0130} \right]$$

### Notes

- The above tap drill information represents probable thread percentages for the standard tap drills stocked at Allied Machine. Special insert diameters may be required in order to meet a user specific percentage of thread requirements.
- The .003 probable mean oversize hole condition is based on optimum cutting conditions. Probable percent of full thread may vary based on less ideal cutting conditions.
- The table and equations on this page are found in the *Machinery's Handbook*. Permission to simplify and print the equations is granted by the Editor of the *Machinery's Handbook*.

### Formulas

1.	<b>RPM</b>	= (3.82 • SFM) / DIA
	where:	
	RPM	= revolutions per minute (rev/min)
	SFM	= speed (ft/min)
	DIA	= diameter of drill (inch)
2.	<b>IPM</b>	= RPM • IPR
	where:	
	IPM	= inches per minute (in/min)
	RPM	= revolutions per minute (rev/min)
	IPR	= feed rate (in/rev)
3.	<b>SFM</b>	= RPM • 0.262 • DIA
	where:	
	SFM	= speed (ft/min)
	RPM	= revolutions per minute (rev/min)
	DIA	= diameter of drill (inch)
4.	<b>Thrust</b>	= 153,700 • IPR • DIA • K <sub>m</sub>
	where:	
	Thrust	= axial thrust (lbs)
	IPR	= feed rate (in/rev)
	DIA	= diameter of drill (inch)
	K <sub>m</sub>	= specific cutting energy (lbs/in <sup>2</sup> )
5.	<b>Tool Power</b>	= .6283 • IPR • RPM • K <sub>m</sub> • DIA <sup>2</sup>
	where:	
	Tool Power	= tool power (HP)
	IPR	= feed rate (in/rev)
	RPM	= revolutions per minute (rev/min)
	K <sub>m</sub>	= specific cutting energy (lbs/in <sup>2</sup> )
	DIA	= diameter of drill (inch)

### Material Constants

Type of Material	Hardness	K <sub>m</sub> (lbs/in <sup>2</sup> )
Plain Carbon and Alloy Steel	85 - 200 BHN	0.79
	200 - 275 BHN	0.94
	275 - 375 BHN	1.00
	375 - 425 BHN	1.15
High Temperature Alloys	-	1.44
Stainless Steels	135 - 275 BHN	0.94
	30 - 45 RC	1.08
Cast Iron	100 - 200 BHN	0.50
	200 - 300 BHN	1.08
Copper Alloy	20 - 80 RB	0.43
	80 - 100 RB	0.72
Titanium Alloy	-	0.72
Aluminum Alloy	-	0.22
Magnesium Alloy	-	0.16

## Coolant Recommendations | Imperial (inch)

### HSS Drill Inserts

ISO	Material	Pressure or Flow Rate	3/8 - 1/2	33/64 - 11/16	23/32 - 1	1 - 1-1/4	1-1/4 - 2	2 - 3	3 - 4
P	Free Machining Steel 1118, 1215, 12L14, etc.	PSI	175 - 185	100 - 120	105 - 140	80 - 115	75 - 100	40 - 50	65 - 90
		GPM	2.5 - 2.6	2.8 - 3.0	4.4 - 5.2	7 - 8	12 - 14	30 - 33	38 - 44
	Low Carbon Steel 1010, 1020, 1025, 1522, 1144, etc.	PSI	165 - 170	75 - 90	75 - 95	60 - 80	55 - 75	30 - 40	50 - 65
		GPM	2.4 - 2.5	2.4 - 2.6	3.7 - 4.2	6 - 7	11 - 12	26 - 30	33 - 38
	Medium Carbon Steel 1030, 1040, 1050, 1527, 1140, 1151, etc.	PSI	160 - 165	70 - 85	70 - 90	55 - 75	50 - 70	30 - 40	50 - 65
		GPM	2.3 - 2.4	2.3 - 2.6	3.7 - 4.2	5 - 6	10 - 12	26 - 30	33 - 38
	Alloy Steel 4140, 5140, 8640, etc.	PSI	160 - 165	65 - 75	65 - 80	50 - 70	45 - 60	30 - 35	40 - 50
		GPM	2.3 - 2.4	2.2 - 2.4	3.5 - 3.9	5 - 6	10 - 11	26 - 28	30 - 33
	High Strength Alloy 4340, 4330V, 300M, etc.	PSI	150 - 155	55 - 60	45 - 50	25 - 30	25 - 30	20 - 25	40 - 50
		GPM	2.3 - 2.4	2.1 - 2.2	2.9 - 3.1	4 - 5	7 - 8	21 - 23	23 - 26
	Structural Steel A36, A285, A516, etc.	PSI	160 - 165	75 - 85	65 - 80	40 - 55	40 - 50	25 - 30	40 - 50
		GPM	2.3 - 2.4	2.4 - 2.6	3.5 - 3.9	5 - 6	9 - 10	23 - 26	30 - 33
Tool Steel H-13, H-21, A-4, O-2, S-3, etc.	PSI	150 - 155	55 - 60	45 - 50	25 - 30	25 - 30	20 - 25	25 - 30	
	GPM	2.3 - 2.4	2.1 - 2.2	2.9 - 3.1	4 - 5	7 - 8	21 - 23	23 - 26	
S	High Temp Alloy Hastelloy B, Inconel 600, etc.	PSI	150 - 155	60 - 65	50 - 55	30 - 35	25 - 30	25 - 30	44
		GPM	2.3 - 2.4	2.2 - 2.3	3.1 - 3.2	4 - 5	7 - 8	23 - 26	33
	Titanium Alloy	PSI	150 - 155	60 - 65	50 - 55	30 - 35	25 - 30	25 - 30	44
		GPM	2.3 - 2.4	2.2 - 2.3	3.1 - 3.2	4 - 5	7 - 8	23 - 26	33
Aerospace Alloy S82	PSI	150 - 155	60 - 65	50 - 55	30 - 35	25 - 30	25 - 30	44	
	GPM	2.3 - 2.4	2.2 - 2.3	3.1 - 3.2	4 - 5	7 - 8	23 - 26	33	
M	Stainless Steel 400 Series 416, 420, etc.	PSI	171	86	75	55	51	29	45
		GPM	3	3	4	6	10	26	31
	Stainless Steel 300 Series 304, 316, 17-4PH, etc.	PSI	171	86	75	55	51	29	45
		GPM	3	3	4	6	10	26	31
	Super Duplex Stainless Steel	PSI	171	86	75	55	51	29	45
		GPM	3	3	4	6	10	26	31
H	Wear Plate Hardox, AR400, T-1, etc.	PSI	155	61	51	29	29	25	29
		GPM	2	2	3	5	8	23	26
	Hardened Steel	PSI	155	61	51	29	29	25	29
		GPM	2	2	3	5	8	23	26
K	SG / Nodular Cast Iron	PSI	160	65	61	41	35	29	35
		GPM	2	2	3	5	9	26	28
	Grey / White Iron	PSI	160	65	61	41	35	29	35
		GPM	2	2	3	5	9	26	28
N	Cast Aluminum	PSI	210	180	230	159	125	51	80
		GPM	3	4	6	9	16	33	42
	Wrought Aluminum	PSI	210	180	230	159	125	51	80
		GPM	3	4	6	9	16	33	42
	Aluminum Bronze	PSI	186	120	140	115	100	51	90
		GPM	2.5	3	5	8	14	33	44
	Brass	PSI	159	65	61	41	35	29	35
		GPM	2	2	3	5	9	26	28
	Copper	PSI	186	120	140	115	100	51	90
		GPM	2.5	3	5	8	14	33	44

#### Deep Hole Drilling Coolant Adjustment

	Holder Length				
	Extended	Long	Long Plus	XL	3XL
Pressure and Flow	1.3	1.5	2	2	3

#### Recommended Coolant Example

If the recommended pressure and flow is 150 PSI and 2.4 GPM for a standard length holder, then the adjusted pressure and flow for a 3XL holder would be 450 PSI and 7.2 GPM.

$$150 \cdot 3 = 450 \text{ PSI} \qquad 2.4 \cdot 3 = 7.2 \text{ GPM}$$

#### ⚠️ WARNING Tool failure can cause serious injury. To prevent:

- When using holders without support bushing, use a short T-A® holder to establish an initial hole that is a minimum of 2 diameters deep.
- Do not rotate tool holder more than 50 RPM unless it is engaged with the workpiece or fixture.

Visit [www.alliedmachine.com/DeepHoleGuidelines](http://www.alliedmachine.com/DeepHoleGuidelines) for the most up-to-date information and procedures. Factory technical assistance is available for your specific applications through our Application Engineering Team.

**IMPORTANT:** The coolant pressure and flow rate recommendations above represent a good approximation to obtain optimum tool life and chip evacuation at Allied Machine recommended speeds and feeds. If lower coolant capabilities exist in a drilling application, the T-A® drilling system will still function at reduced penetration rates. Contact our Application Engineering department for a more specific recommendation of coolant requirements and/or speeds and feeds.

## Coolant Recommendations | Imperial (inch)

### Carbide Drill Inserts

ISO	Material	Pressure or Flow Rate	3/8 - 1/2	33/64 - 11/16	23/32 - 1	1 - 1-3/8	1-13/32 - 1-7/8
P	Free Machining Steel 1118, 1215, 12L14, etc.	PSI	195	140	160	140	155
		GPM	2.6	3.3	5.5	9	18
	Low Carbon Steel 1010, 1020, 1025, 1522, 1144, etc.	PSI	180	105	105	110	115
		GPM	2.5	2.9	4.4	8	15
	Medium Carbon Steel 1030, 1040, 1050, 1527, 1140, 1151, etc.	PSI	175	100	90	70	75
		GPM	2.5	2.8	4.1	7	13
	Alloy Steel 4140, 5140, 8640, etc.	PSI	165	85	100	75	70
		GPM	2.4	2.6	4.3	6	12
	High Strength Alloy 4340, 4330V, 300M, etc.	PSI	175	115	105	75	70
		GPM	2.4	2.3	3.2	5	8
Structural Steel A36, A285, A516, etc.	PSI	175	115	105	75	70	
	GPM	2.5	3.0	4.4	6	12	
Tool Steel H-13, H-21, A-4, O-2, S-3, etc.	PSI	155	60	55	40	35	
	GPM	2.4	2.2	3.2	5	8	
S	High Temp Alloy Hastelloy B, Inconel 600, etc.	PSI	247	160	174	160	130
		GPM	3	4	6	9	16
	Titanium Alloy	PSI	247	160	174	160	130
		GPM	3	4	6	9	16
Aerospace Alloy S82	PSI	247	160	174	160	130	
	GPM	3	4	6	9	16	
M	Stainless Steel 400 Series 416, 420, etc.	PSI	329	239	260	250	190
		GPM	3	4	7	12	20
	Stainless Steel 300 Series 304, 316, 17-4PH, etc.	PSI	329	239	260	250	190
		GPM	3	4	7	12	20
Super Duplex Stainless Steel	PSI	329	239	260	250	190	
	GPM	3	4	7	12	20	
H	Wear Plate Hardox, AR400, T-1, etc.	PSI	210	75	70	49	45
		GPM	3	2	4	5	10
	Hardened Steel	PSI	210	75	70	49	45
		GPM	3	2	4	5	10
K	SG / Nodular Cast Iron	PSI	225	104	90	90	80
		GPM	3	3	4	7	13
	Grey / White Iron	PSI	225	104	90	90	80
		GPM	3	3	4	7	13
N	Cast Aluminum	PSI	350	319	315	284	200
		GPM	4	5	8	12	20
	Wrought Aluminum	PSI	350	319	315	284	200
		GPM	4	5	8	12	20
	Aluminum Bronze	PSI	290	239	239	220	174
		GPM	3	4	7	11	19
	Brass	PSI	350	319	315	284	200
		GPM	4	5	7	12	20
	Copper	PSI	290	239	239	220	174
		GPM	3	4	7	11	19

#### Deep Hole Drilling Coolant Adjustment

	Holder Length				
	Extended	Long	Long Plus	XL	3XL
Pressure and Flow	1.3	1.5	2	2	3

#### Recommended Coolant Example

If the recommended pressure and flow is 150 PSI and 2.4 GPM for a standard length holder, then the adjusted pressure and flow for a 3XL holder would be 450 PSI and 7.2 GPM.

$$150 \cdot 3 = 450 \text{ PSI}$$

$$2.4 \cdot 3 = 7.2 \text{ GPM}$$

#### ⚠️ WARNING Tool failure can cause serious injury. To prevent:

- When using holders without support bushing, use a short T-A® holder to establish an initial hole that is a minimum of 2 diameters deep.
- Do not rotate tool holder more than 50 RPM unless it is engaged with the workpiece or fixture.

Visit [www.alliedmachine.com/DeepHoleGuidelines](http://www.alliedmachine.com/DeepHoleGuidelines) for the most up-to-date information and procedures. Factory technical assistance is available for your specific applications through our Application Engineering Team.

**IMPORTANT:** The coolant pressure and flow rate recommendations above represent a good approximation to obtain optimum tool life and chip evacuation at Allied Machine recommended speeds and feeds. If lower coolant capabilities exist in a drilling application, the T-A® drilling system will still function at reduced penetration rates. Contact our Application Engineering department for a more specific recommendation of coolant requirements and/or speeds and feeds.

## GEN2 T-A Recommended Drilling Data | Metric (mm)

### HSS Inserts

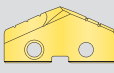
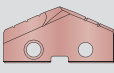
ISO	Material	Hardness (BHN)	HSS Grade	M/min		Feed Rate (mm/rev) by Diameter	
				 TiN	 AM200®	9.50 - 12.95	12.98 - 17.52
P	Free Machining Steel 1118, 1215, 12L14, etc.	100 - 150	HSS	61	99	0.20	0.30
		150 - 200	HSS	55	91	0.18	0.28
		200 - 250	HSS	49	85	0.15	0.25
	Low Carbon Steel 1010, 1020, 1025, 1522, 1144, etc.	85 - 125	HSS	52	88	0.20 ❖	0.25
		125 - 175	HSS	49	83	0.18 ❖	0.25
		175 - 225	HSS	46	79	0.15 ❖	0.23
	Medium Carbon Steel 1030, 1040, 1050, 1527, 1140, 1151, etc.	225 - 275	HSS	43	73	0.13 ❖	0.23
		125 - 175	HSS	49	83	0.18	0.25
		175 - 225	HSS	46	79	0.15	0.23
	Alloy Steel 4140, 5140, 8640, etc.	225 - 275	HSS	43	73	0.15	0.23
		275 - 325	SC, PC	40	68	0.13	0.20
		325 - 375	SC, PC	34	54	0.10	0.18
275 - 325		SC, PC	37	59	0.13	0.20	
High Strength Alloy 4340, 4330V, 300M, etc.	350 - 400	PC	15	24	0.10 ❖	0.18	
	225 - 300	SC, PC	24	38	0.15 ❖	0.23	
	300 - 350	SC, PC	18	30	0.13 ❖	0.20	
Structural Steel A36, A285, A516, etc.	350 - 400	PC	15	24	0.10 ❖	0.18	
	100 - 150	HSS	43	71	0.20 ❖	0.28	
	150 - 250	HSS	37	57	0.15 ❖	0.25	
Tool Steel H-13, H-21, A-4, O-2, S-3, etc.	250 - 350	SC, PC	30	48	0.13 ❖	0.23	
	150 - 200	SC	24	38	0.10	0.18	
S	High Temp Alloy Hastelloy B, Inconel 600, etc.	200 - 250	SC, PC	18	32	0.10	0.18
		140 - 220	SC, PC	9	13	0.10 ❖	0.18
	Titanium Alloy	220 - 310	PC	8	12	0.10 ❖	0.15
		140 - 220	SC, PC	11	16	0.10 ❖	0.18
	Aerospace Alloy S82	220 - 310	PC	10	15	0.08 ❖	0.15
185 - 275		SC, PC	23	35	0.15 ❖	0.20	
M	Stainless Steel 400 Series 416, 420, etc.	275 - 350	SC, PC	18	31	0.13 ❖	0.18
		185 - 275	SC, PC	15	22	0.08 ❖	0.15
	Stainless Steel 300 Series 304, 316, 17-4PH, etc.	135 - 185	SC, PC	23	35	0.08 ❖	0.18
		185 - 275	SC, PC	18	31	0.08 ❖	0.15
	Super Duplex Stainless Steel	135 - 185	SC, PC	18	26	0.08 ❖	0.18
185 - 275		SC, PC	15	22	0.08 ❖	0.15	
H	Wear Plate Hardox, AR400, T-1, etc.	400	SC, PC	14	21	0.08 ❖	0.15
		500	PC	10	14	0.05 ❖	0.12
		600	N/A	-	-	-	-
	Hardened Steel	300 - 400	PC	15	29	0.10 ❖	0.15
400 - 500		PC	10	14	0.06 ❖	0.12	
K	Nodular, Grey, Ductile Cast Iron	120 - 150	HSS	52	84	0.20	0.30
		150 - 200	HSS	46	79	0.18	0.28
		200 - 220	HSS	40	68	0.15	0.23
		220 - 260	SC, PC	34	57	0.13	0.20
		260 - 320	SC, PC	27	47	0.13	0.18
N	Cast Aluminum	30	HSS	183	-	0.23	0.38
		180	HSS	91	-	0.20	0.33
	Wrought Aluminum	30	HSS	183	280	0.12	0.33
		180	HSS	91	200	0.12	0.18
	Aluminum Bronze	100 - 200	SC	52	82	0.15	0.24
		200 - 250	SC	40	65	0.12	0.18
	Brass	100	HSS	91	144	0.18	0.27
Copper	60	SC	40	58	0.07 ❖	0.10	

❖ Contact our Application Engineering department for assistance when machining these materials

**IMPORTANT:** The speeds and feeds listed above are a general starting point for all applications. Refer to the Coolant Recommendation charts for coolant requirements to run at the recommended speeds and feeds. Factory technical assistance is available through our Application Engineering department. See adjustment examples on the following page.

Feed Rate (mm/rev) by Diameter				
17.53 - 24.38	24.41 - 35.00	35.01 - 47.80	47.85 - 65.99	66.00 - 114.48
0.41	0.48	0.51	0.58	0.71
0.38	0.43	0.51	0.58	0.71
0.36	0.41	0.51	0.58	0.71
0.36	0.46	0.48	0.58	0.69
0.36	0.43	0.48	0.58	0.69
0.33	0.41	0.46	0.53	0.61
0.33	0.41	0.46	0.53	0.61
0.36	0.43	0.48	0.58	0.69
0.33	0.41	0.46	0.53	0.61
0.33	0.41	0.46	0.53	0.61
0.30	0.38	0.41	0.48	0.56
0.36	0.43	0.43	0.48	0.56
0.33	0.41	0.43	0.48	0.56
0.33	0.41	0.43	0.48	0.56
0.30	0.38	0.38	0.43	0.51
0.28	0.36	0.38	0.43	0.51
0.28	0.33	0.36	0.43	0.51
0.25	0.30	0.36	0.43	0.51
0.23	0.28	0.30	0.41	0.46
0.38	0.43	0.46	0.53	0.66
0.33	0.38	0.41	0.48	0.61
0.30	0.33	0.36	0.43	0.51
0.25	0.30	0.30	0.38	0.43
0.25	0.30	0.30	0.38	0.43
0.23	0.28	0.30	0.38	-
0.20	0.25	0.25	0.30	-
0.21	0.27	0.30	0.38	-
0.18	0.23	0.25	0.30	-
0.23	0.28	0.36	0.41	0.51
0.20	0.25	0.30	0.36	0.46
0.23	0.28	0.36	0.41	0.51
0.20	0.25	0.30	0.36	0.46
0.23	0.28	0.36	0.41	0.51
0.20	0.25	0.30	0.36	0.46
0.20	0.23	0.30	0.41	0.46
0.18	0.20	0.25	0.30	0.40
-	-	-	-	-
0.23	0.27	0.30	0.41	0.46
0.18	0.24	0.25	0.30	0.40
0.41	0.51	0.61	0.69	0.76
0.38	0.48	0.56	0.64	0.71
0.33	0.43	0.46	0.53	0.61
0.28	0.36	0.36	0.43	0.51
0.25	0.28	0.28	0.36	0.41
0.46	0.58	0.56	0.64	0.64
0.40	0.50	0.56	0.64	0.64
0.40	0.50	0.56	0.64	0.64
0.30	0.35	0.56	0.64	0.64
0.30	0.38	0.43	0.48	0.53
0.23	0.28	0.36	0.40	0.46
0.33	0.45	0.47	0.53	0.58
0.18	0.26	0.23	0.27	0.31

Deep Hole Drilling Speed and Feed Adjustment

	Holder Length				
	Extended	Long	Long Plus	XL	3XL
Speed	0.90	0.85	0.80	0.80	0.75
Feed	-	0.95	0.90	0.90	0.90

Recommended Speed and Feed Example

If the recommended speed and feed is 50 M/min and 0.20 mm/rev for a standard length holder, then the speed and feed using a 3XL holder in the same application would be 37.5 M/min and 0.18 mm/rev.

$50 \cdot 0.75 = 37.5 \text{ M/min}$        $0.20 \cdot 0.90 = 0.18 \text{ mm/rev}$

Formulas

- RPM = (318.47 • M/min) / DIA**

where:  
 RPM = revolutions per minute (rev/min)  
 M/min = speed (M/min)  
 DIA = diameter of drill (mm)
- mm/min = RPM • mm/rev**

where:  
 mm/min = mm per minute (mm/min)  
 RPM = revolutions per minute (rev/min)  
 mm/rev = feed rate (mm/rev)
- M/min = RPM • 0.003 • DIA**

where:  
 M/min = speed (M/min)  
 RPM = revolutions per minute (rev/min)  
 DIA = diameter of drill (mm)

**⚠ WARNING** Tool failure can cause serious injury. To prevent:

- When using holders without support bushing, use a short T-A® holder to establish an initial hole that is a minimum of 2 diameters deep.
- Do not rotate tool holder more than 50 RPM unless it is engaged with the workpiece or fixture.

Visit [www.alliedmachine.com/DeepHoleGuidelines](http://www.alliedmachine.com/DeepHoleGuidelines) for the most up-to-date information and procedures. Factory technical assistance is available for your specific applications through our Application Engineering Team.

## GEN2 T-A Recommended Drilling Data | Metric (mm)

### Carbide Inserts

ISO	Material	Hardness (BHN)	Carbide Grade	M/min  AM300®	Feed Rate (mm/rev) by Diameter			
					9.50 - 12.95	12.98 - 17.53	17.54 - 24.38	24.41 - 35.00
P	Free Machining Steel 1118, 1215, 12L14, etc.	100 - 150	C1	146	0.20	0.30	0.41	0.48
		150 - 200	C1	126	0.18	0.28	0.38	0.43
		200 - 250	C1	119	0.15	0.25	0.36	0.41
	Low Carbon Steel 1010, 1020, 1025, 1522, 1144, etc.	85 - 125	C1	137	0.20 ❖	0.25	0.36	0.46
		125 - 175	C1	119	0.18 ❖	0.25	0.36	0.43
		175 - 225	C1	108	0.15 ❖	0.23	0.33	0.41
	Medium Carbon Steel 1030, 1040, 1050, 1527, 1140, 1151, etc.	225 - 275	C1	95	0.13 ❖	0.23	0.33	0.41
		125 - 175	C1	119	0.18	0.25	0.36	0.43
		175 - 225	C1	108	0.15	0.23	0.33	0.41
	Alloy Steel 4140, 5140, 8640, etc.	225 - 275	C1	95	0.15	0.23	0.33	0.41
		275 - 325	C1	80	0.13	0.20	0.30	0.38
		325 - 375	C1	78	0.10	0.18	0.28	0.36
125 - 175		C1	115	0.18	0.25	0.36	0.43	
175 - 225		C1	105	0.15	0.23	0.33	0.43	
High Strength Alloy 4340, 4330V, 300M, etc.	225 - 300	C1	70	0.15 ❖	0.23	0.28	0.33	
	300 - 350	C1	63	0.13 ❖	0.20	0.25	0.30	
	350 - 400	C1	56	0.10 ❖	0.18	0.23	0.28	
Structural Steel A36, A285, A516, etc.	100 - 150	C1	108	0.20 ❖	0.28	0.38	0.43	
	150 - 250	C1	87	0.15 ❖	0.25	0.33	0.38	
	250 - 350	C1	80	0.13 ❖	0.23	0.30	0.33	
Tool Steel H-13, H-21, A-4, O-2, S-3, etc.	150 - 200	C1	78	0.10	0.18	0.25	0.30	
	200 - 250	C1	59	0.10	0.18	0.25	0.30	
S	High Temp Alloy Hastelloy B, Inconel 600, etc.	140 - 220	C2	37	0.10 ❖	0.18	0.23	0.28
		220 - 310	C2	29	0.10 ❖	0.15	0.20	0.25
	Titanium Alloy	140 - 220	C2	42	0.10 ❖	0.18	0.21	0.27
		220 - 310	C2	33	0.08 ❖	0.15	0.18	0.23
	Aerospace Alloy S82	185 - 275	C2	73	0.12 ❖	0.16	0.18	0.22
275 - 350		C2	56	0.10 ❖	0.14	0.16	0.19	
M	Stainless Steel 400 Series 416, 420, etc.	185 - 275	C2	73	0.18 ❖	0.23	0.30	0.36
		275 - 350	C2	56	0.15 ❖	0.20	0.28	0.30
	Stainless Steel 300 Series 304, 316, 17-4PH, etc.	135 - 185	C2	73	0.14 ❖	0.18	0.24	0.29
		185 - 275	C2	56	0.12 ❖	0.16	0.22	0.24
	Super Duplex Stainless Steel	135 - 185	C2	38	0.12 ❖	0.17	0.22	0.26
185 - 275		C2	30	0.10 ❖	0.15	0.18	0.22	

❖ Contact our Application Engineering department for assistance when machining these materials

**IMPORTANT:** The speeds and feeds listed above are a general starting point for all applications. Refer to the Coolant Recommendation charts for coolant requirements to run at the recommended speeds and feeds. Factory technical assistance is available through our Application Engineering department. See adjustment examples on the following page.

ISO	Material	Hardness (BHN)	Carbide Grade	M/min	Feed Rate (mm/rev) by Diameter			
				 AM300®	9.50 - 12.95	12.98 - 17.53	17.54 - 24.38	24.41 - 35.00
H	Wear Plate Hardox, AR400, T-1, etc.	400	C2	45	0.07 ❖	0.12	0.20	0.25
		500	C2	37	0.05 ❖	0.10	0.15	0.20
		600	C2	30	0.04 ❖	0.08	0.12	0.16
	Hardened Steel	300 - 400	C1	47	0.10 ❖	0.18	0.23	0.27
		400 - 500	C1	37	0.06 ❖	0.12	0.18	0.24
K	Nodular, Grey, Ductile Cast Iron	120 - 150	C2	152	0.20	0.30	0.38	0.48
		150 - 200	C2	146	0.18	0.28	0.33	0.43
		200 - 220	C2	131	0.15	0.23	0.30	0.38
		220 - 260	C2	113	0.13	0.20	0.28	0.33
		260 - 320	C2	102	0.13	0.18	0.25	0.28
N	Cast Aluminum	30	C2	300	0.23	0.38	0.46	0.58
		180	C2	225	0.20	0.33	0.40	0.50
	Wrought Aluminum	30	C2	426	0.12	0.33	0.40	0.50
		180	C2	300	0.12	0.18	0.30	0.35
	Aluminum Bronze	100 - 200	C2	110	0.15	0.24	0.30	0.38
		200 - 250	C2	90	0.12	0.18	0.23	0.28
	Brass	100	C2	200	0.18	0.27	0.33	0.45
Copper	60	C2	130	0.07 ❖	0.10	0.18	0.26	

❖ Contact our Application Engineering department for assistance when machining these materials

**Deep Hole Drilling Speed and Feed Adjustment**

	⚠ Holder Length				
	Extended	Long	Long Plus	XL	3XL
Speed	0.90	0.85	0.80	0.80	0.75
Feed	-	0.95	0.90	0.90	0.90

**Recommended Speed and Feed Example**

If the recommended speed and feed is 50 M/min and 0.20 mm/rev for a standard length holder, then the speed and feed using a 3XL holder in the same application would be 37.5 M/min and 0.18 mm/rev.

$50 \cdot 0.75 = 37.5 \text{ M/min}$	$0.20 \cdot 0.90 = 0.18 \text{ mm/rev}$
--------------------------------------	---

**Formulas**

1. <b>RPM = (318.47 • M/min) / DIA</b> where: RPM = revolutions per minute (rev/min) M/min = speed (M/min) DIA = diameter of drill (mm)	2. <b>mm/min = RPM • mm/rev</b> where: mm/min = mm per minute (mm/min) RPM = revolutions per minute (rev/min) mm/rev = feed rate (mm/rev)	3. <b>M/min = RPM • 0.003 • DIA</b> where: M/min = speed (M/min) RPM = revolutions per minute (rev/min) DIA = diameter of drill (mm)
---	---	--



**⚠ WARNING** Tool failure can cause serious injury. To prevent:

- When using holders without support bushing, use a short T-A® holder to establish an initial hole that is a minimum of 2 diameters deep.
- Do not rotate tool holder more than 50 RPM unless it is engaged with the workpiece or fixture.

Visit [www.alliedmachine.com/DeepHoleGuidelines](http://www.alliedmachine.com/DeepHoleGuidelines) for the most up-to-date information and procedures. Factory technical assistance is available for your specific applications through our Application Engineering Team.

## Original T-A Recommended Drilling Data | Metric (mm)

### HSS Inserts

ISO	Material	Hardness (BHN)	HSS Grade	M/min			Feed Rate (mm/rev) by Diameter	
				 TiN	 TiAlN	 TiCN	9.50 - 12.95	12.98 - 17.52
P	Free Machining Steel 1118, 1215, 12L14, etc.	100 - 150	HSS	61	85	79	0.18	0.25
		150 - 200	HSS	55	79	72	0.18	0.25
		200 - 250	HSS	49	73	64	0.15	0.25
	Low Carbon Steel 1010, 1020, 1025, 1522, 1144, etc.	85 - 125	HSS	52	76	67	0.15 ❖	0.23
		125 - 175	HSS	49	73	64	0.15 ❖	0.23
		175 - 225	HSS	46	69	59	0.13 ❖	0.20
	Medium Carbon Steel 1030, 1040, 1050, 1527, 1140, 1151, etc.	225 - 275	HSS	43	64	55	0.13 ❖	0.20
		125 - 175	HSS	49	73	64	0.15	0.23
		175 - 225	HSS	46	69	59	0.13	0.20
	Alloy Steel 4140, 5140, 8640, etc.	225 - 275	HSS	43	64	55	0.13	0.20
		275 - 325	SC, PC	40	59	52	0.10	0.18
		275 - 325	SC, PC	40	59	52	0.10	0.15
325 - 375		SC, PC	34	47	44	0.08	0.15	
High Strength Alloy 4340, 4330V, 300M, etc.	225 - 300	SC, PC	24	34	30	0.13 ❖	0.18	
	300 - 350	SC, PC	18	26	24	0.10 ❖	0.18	
	350 - 400	PC	15	21	20	0.08 ❖	0.15	
Structural Steel A36, A285, A516, etc.	100 - 150	HSS	43	61	55	0.15 ❖	0.25	
	150 - 250	HSS	37	52	47	0.13 ❖	0.23	
	250 - 350	SC, PC	30	43	40	0.10 ❖	0.20	
Tool Steel H-13, H-21, A-4, O-2, S-3, etc.	150 - 200	SC	24	34	32	0.10	0.15	
	200 - 250	SC, PC	18	27	26	0.10	0.15	
S	High Temp Alloy Hastelloy B, Inconel 600, etc.	140 - 220	SC, PC	9	12	11	0.08 ❖	0.18
		220 - 310	PC	8	11	9	0.08 ❖	0.15
	Titanium Alloy	140 - 220	SC, PC	11	15	14	0.08 ❖	0.18
		220 - 310	PC	9	14	11	0.08 ❖	0.15
Aerospace Alloy S82	185 - 275	SC, PC	23	32	29	0.15 ❖	0.20	
	275 - 350	SC, PC	18	27	24	0.13 ❖	0.18	
M	Stainless Steel 400 Series 416, 420, etc.	185 - 275	SC, PC	23	32	29	0.15 ❖	0.20
		275 - 350	SC, PC	18	27	24	0.13 ❖	0.18
	Stainless Steel 300 Series 304, 316, 17-4PH, etc.	135 - 185	SC, PC	23	32	29	0.08 ❖	0.18
		185 - 275	SC, PC	18	27	24	0.08 ❖	0.15
	Super Duplex Stainless Steel	135 - 185	SC, PC	18	24	21	0.08 ❖	0.18
185 - 275		SC, PC	15	20	18	0.08 ❖	0.15	
H	Wear Plate Hardox, AR400, T-1, etc.	400	SC, PC	14	21	17	0.08 ❖	0.15
		500	PC	11	14	12	0.05 ❖	0.13
		600	N/A	-	-	-	-	-
	Hardened Steel	300 - 400	PC	15	29	21	0.08 ❖	0.15
400 - 500		PC	11	14	12	0.05 ❖	0.13	
K	Nodular, Grey, Ductile Cast Iron	120 - 150	HSS	52	76	67	0.18	0.30
		150 - 200	HSS	46	69	59	0.15	0.28
		200 - 220	HSS	40	59	52	0.15	0.23
		220 - 260	SC, PC	34	50	44	0.13	0.18
		260 - 320	SC, PC	27	41	37	0.10	0.15
N	Cast Aluminum	30	HSS	183	259	229	0.20	0.33
		180	HSS	91	137	122	0.20	0.33
	Wrought Aluminum	30	HSS	183	259	229	0.10	0.15
		180	HSS	91	137	122	0.20	0.33
	Aluminum Bronze	100 - 200	SC	52	76	67	0.15	0.28
		200 - 250	SC	40	58	52	0.13	0.18
	Brass	100	HSS	91	136	122	0.18	0.30
Copper	60	SC	40	50	46	0.05 ❖	0.08	

❖ Contact our Application Engineering department for assistance when machining these materials

**IMPORTANT:** The speeds and feeds listed above are a general starting point for all applications. Refer to the Coolant Recommendation charts for coolant requirements to run at the recommended speeds and feeds. Factory technical assistance is available through our Application Engineering department. See adjustment examples on the following page.



Feed Rate (mm/rev) by Diameter				
17.53 - 24.38	24.41 - 35.00	35.01 - 47.80	47.85 - 65.99	66.00 - 114.48
0.33	0.41	0.51	0.58	0.71
0.33	0.41	0.51	0.58	0.71
0.33	0.41	0.51	0.58	0.71
0.30	0.38	0.48	0.58	0.69
0.30	0.38	0.48	0.58	0.69
0.25	0.36	0.46	0.53	0.61
0.25	0.36	0.46	0.53	0.61
0.30	0.38	0.48	0.58	0.69
0.25	0.36	0.46	0.53	0.61
0.25	0.36	0.46	0.53	0.61
0.23	0.30	0.41	0.48	0.56
0.25	0.36	0.43	0.48	0.56
0.25	0.36	0.43	0.48	0.56
0.25	0.36	0.43	0.48	0.56
0.23	0.30	0.38	0.43	0.51
0.23	0.30	0.38	0.43	0.51
0.23	0.25	0.36	0.43	0.51
0.23	0.25	0.36	0.43	0.51
0.20	0.23	0.30	0.38	0.46
0.30	0.36	0.46	0.53	0.66
0.25	0.30	0.41	0.48	0.61
0.23	0.25	0.36	0.43	0.51
0.20	0.25	0.30	0.38	0.43
0.20	0.25	0.30	0.38	0.43
0.20	0.25	0.30	0.38	0.43
0.18	0.20	0.25	0.30	0.38
0.18	0.20	0.25	0.30	0.38
0.18	0.20	0.25	0.30	0.38
0.23	0.25	0.36	0.41	0.51
0.20	0.20	0.30	0.36	0.46
0.23	0.25	0.36	0.41	0.51
0.20	0.20	0.30	0.36	0.46
0.20	0.20	0.30	0.36	0.46
0.20	0.23	0.30	0.41	0.46
0.18	0.20	0.25	0.30	0.41
-	-	-	-	-
0.20	0.23	0.30	0.41	0.46
0.18	0.20	0.25	0.30	0.41
0.41	0.51	0.61	0.69	0.76
0.36	0.46	0.56	0.64	0.71
0.30	0.41	0.46	0.53	0.61
0.23	0.30	0.36	0.43	0.51
0.18	0.23	0.30	0.36	0.41
0.41	0.51	0.56	0.64	0.64
0.41	0.46	0.56	0.64	0.64
0.25	0.30	0.56	0.64	0.64
0.41	0.46	0.56	0.64	0.64
0.36	0.46	0.56	0.66	0.71
0.23	0.30	0.36	0.43	0.51
0.41	0.51	0.61	0.71	0.76
0.15	0.20	0.30	0.36	0.41

**Deep Hole Drilling Speed and Feed Adjustment**

	Holder Length				
	Extended	Long	Long Plus	XL	3XL
Speed	0.90	0.85	0.80	0.80	0.75
Feed	-	0.95	0.90	0.90	0.90

**Recommended Speed and Feed Example**

If the recommended speed and feed is 50 M/min and 0.20 mm/rev for a standard length holder, then the speed and feed using a 3XL holder in the same application would be 37.5 M/min and 0.18 mm/rev.

$50 \cdot 0.75 = 37.5 \text{ M/min}$        $0.20 \cdot 0.90 = 0.18 \text{ mm/rev}$

**Formulas**

- RPM = (318.47 • M/min) / DIA**

where:  
 RPM = revolutions per minute (rev/min)  
 M/min = speed (M/min)  
 DIA = diameter of drill (mm)
- mm/min = RPM • mm/rev**



where:  
 mm/min = mm per minute (mm/min)  
 RPM = revolutions per minute (rev/min)  
 mm/rev = feed rate (mm/rev)
- M/min = RPM • 0.003 • DIA**

where:  
 M/min = speed (M/min)  
 RPM = revolutions per minute (rev/min)  
 DIA = diameter of drill (mm)

**⚠ WARNING** Tool failure can cause serious injury. To prevent:  
 - When using holders without support bushing, use a short T-A® holder to establish an initial hole that is a minimum of 2 diameters deep.  
 - Do not rotate tool holder more than 50 RPM unless it is engaged with the workpiece or fixture.  
 Visit [www.alliedmachine.com/DeepHoleGuidelines](http://www.alliedmachine.com/DeepHoleGuidelines) for the most up-to-date information and procedures. Factory technical assistance is available for your specific applications through our Application Engineering Team.



## Original T-A Recommended Drilling Data | Metric (mm)

### Carbide Inserts

ISO	Material	Hardness (BHN)	Carbide Grade	M/min			Feed Rate (mm/rev) by Diameter				
				 TiN	 TiAlN	 TiCN	9.50 - 12.95	12.98 - 17.52	17.53 - 24.38	24.41 - 35.00	35.01 - 47.80
P	<b>Free Machining Steel</b> 1118, 1215, 12L14, etc.	100 - 150	C5	96	128	115	0.20	0.30	0.38	0.45	0.53
		150 - 200	C5	85	110	100	0.18	0.28	0.35	0.40	0.48
		200 - 250	C5	79	104	90	0.15	0.25	0.33	0.38	0.43
	<b>Low Carbon Steel</b> 1010, 1020, 1025, 1522, 1144, etc.	85 - 125	C5	91	119	110	0.20 ❖	0.25	0.33	0.43	0.48
		125 - 175	C5	79	104	90	0.18 ❖	0.25	0.33	0.40	0.45
		175 - 225	C5	73	95	82	0.15 ❖	0.23	0.30	0.38	0.43
	<b>Medium Carbon Steel</b> 1030, 1040, 1050, 1527, 1140, 1151, etc.	125 - 175	C5	79	104	90	0.18	0.25	0.33	0.40	0.45
		175 - 225	C5	73	95	84	0.15	0.23	0.30	0.38	0.43
		225 - 275	C5	67	83	72	0.15	0.23	0.30	0.38	0.43
	<b>Alloy Steel</b> 4140, 5140, 8640, etc.	275 - 325	C5	55	70	62	0.13	0.20	0.28	0.35	0.40
		125 - 175	C5	76	99	87	0.18	0.25	0.33	0.40	0.45
		175 - 225	C5	70	92	80	0.15	0.23	0.30	0.38	0.43
225 - 275		C5	64	83	72	0.15	0.23	0.30	0.38	0.43	
275 - 325		C5	61	76	68	0.13	0.20	0.28	0.35	0.40	
<b>High Strength Alloy</b> 4340, 4330V, 300M, etc.	325 - 375	C5	52	67	60	0.10	0.18	0.25	0.33	0.38	
	225 - 300	C5	49	61	55	0.15 ❖	0.23	0.25	0.30	0.38	
	300 - 350	C5	43	55	49	0.13 ❖	0.20	0.23	0.28	0.35	
<b>Structural Steel</b> A36, A285, A516, etc.	350 - 400	C5	37	49	43	0.10 ❖	0.18	0.20	0.25	0.30	
	100 - 150	C5	73	95	84	0.20 ❖	0.28	0.35	0.40	0.45	
	150 - 250	C5	61	76	68	0.15 ❖	0.25	0.30	0.35	0.40	
<b>Tool Steel</b> H-13, H-21, A-4, O-2, S-3, etc.	250 - 350	C5	55	70	62	0.13 ❖	0.23	0.28	0.30	0.35	
	150 - 200	C5	49	67	58	0.10	0.18	0.23	0.28	0.33	
	200 - 250	C5	37	52	45	0.10	0.18	0.23	0.28	0.33	
	S	<b>High Temp Alloy</b> Hastelloy B, Inconel 600, etc.	140 - 220	C2	24	32	28	0.10 ❖	0.18	0.23	0.28
220 - 310			C2	18	26	22	0.10 ❖	0.15	0.20	0.25	0.30
<b>Titanium Alloy</b>		140 - 220	C2	30	38	32	0.10 ❖	0.18	0.23	0.28	0.33
		220 - 310	C2	24	33	28	0.10 ❖	0.15	0.20	0.25	0.30
<b>Aerospace Alloy</b> S82		185 - 275	C2	49	64	57	0.17 ❖	0.22	0.29	0.35	0.40
	275 - 350	C2	37	49	43	0.14 ❖	0.19	0.27	0.30	0.35	
M	<b>Stainless Steel 400 Series</b> 416, 420, etc.	185 - 275	C2	49	64	57	0.17 ❖	0.22	0.29	0.35	0.40
		275 - 350	C2	37	49	43	0.14 ❖	0.19	0.27	0.30	0.35
	<b>Stainless Steel 300 Series</b> 304, 316, 17-4PH, etc.	135 - 185	C2	49	64	57	0.13 ❖	0.17	0.22	0.26	0.30
		185 - 275	C2	37	49	43	0.11 ❖	0.14	0.20	0.22	0.25
	<b>Super Duplex Stainless Steel</b>	135 - 185	C2	25	33	29	0.11 ❖	0.15	0.19	0.23	0.27
185 - 275		C2	19	25	22	0.09 ❖	0.13	0.18	0.20	0.23	

❖ Contact our Application Engineering department for assistance when machining these materials

**IMPORTANT:** The speeds and feeds listed above are a general starting point for all applications. Refer to the Coolant Recommendation charts for coolant requirements to run at the recommended speeds and feeds. Factory technical assistance is available through our Application Engineering department. See adjustment examples on the following page.

ISO	Material	Hardness (BHN)	Carbide Grade	M/min			Feed Rate (mm/rev) by Diameter				
				 TiN	 TiAlN	 TiCN	9.50 - 12.95	12.98 - 17.52	17.53 - 24.38	24.41 - 35.00	35.01 - 47.80
H	Wear Plate Hardox, AR400, T-1, etc.	400	C5	23	35	30	0.07	0.12	0.20	0.25	0.30
		500	C5	15	26	21	0.05	0.10	0.15	0.20	0.25
		600	C5	11	22	16	0.04	0.08	0.12	0.16	0.20
	Hardened Steel	300 - 400	C5	34	43	39	0.10 ❖	0.18	0.23	0.28	0.33
400 - 500		C5	20	25	23	0.08 ❖	0.15	0.20	0.23	0.28	
K	Nodular, Grey, Ductile Cast Iron	120 - 150	C2, C3	98	141	127	0.20	0.30	0.38	0.48	0.58
		150 - 200	C2, C3	82	122	102	0.18	0.28	0.33	0.43	0.53
		200 - 220	C2, C3	73	110	93	0.15	0.23	0.30	0.38	0.45
		220 - 260	C2, C3	64	95	79	0.13	0.20	0.28	0.33	0.38
		260 - 320	C2, C3	55	83	69	0.13	0.18	0.25	0.28	0.33
N	Cast Aluminum	30	C2	366	460	410	0.25	0.38	0.45	0.50	0.55
		180	C2	244	306	275	0.23	0.33	0.40	0.45	0.50
	Wrought Aluminum	30	C2	366	460	410	0.10	0.15	0.25	0.30	0.36
		180	C2	244	306	275	0.20	0.28	0.36	0.45	0.50
	Aluminum Bronze	100 - 200	C2	85	110	100	0.13	0.20	0.25	0.36	0.42
		200 - 250	C2	64	94	79	0.10	0.15	0.18	0.25	0.33
	Brass	100	C2	130	184	160	0.15	0.23	0.28	0.38	0.45
Copper	60	C2	80	120	100	0.05 ❖	0.08	0.10	0.15	0.25	

❖ Contact our Application Engineering department for assistance when machining these materials

**Deep Hole Drilling Speed and Feed Adjustment**

	⚠ Holder Length				
	Extended	Long	Long Plus	XL	3XL
Speed	0.90	0.85	0.80	0.80	0.75
Feed	-	0.95	0.90	0.90	0.90

**Recommended Speed and Feed Example**

If the recommended speed and feed is 50 M/min and 0.20 mm/rev for a standard length holder, then the speed and feed using a 3XL holder in the same application would be 37.5 M/min and 0.18 mm/rev.

$50 \cdot 0.75 = 37.5 \text{ M/min}$	$0.20 \cdot 0.90 = 0.18 \text{ mm/rev}$
--------------------------------------	---

**Formulas**

<p>1. <math>RPM = (318.47 \cdot M/min) / DIA</math></p> <p>where:</p> <p>RPM = revolutions per minute (rev/min)</p> <p>M/min = speed (M/min)</p> <p>DIA = diameter of drill (mm)</p>	<p>2. <math>mm/min = RPM \cdot mm/rev</math></p> <p>where:</p> <p>mm/min = mm per minute (mm/min)</p> <p>RPM = revolutions per minute (rev/min)</p> <p>mm/rev = feed rate (mm/rev)</p>	<p>3. <math>M/min = RPM \cdot 0.003 \cdot DIA</math></p> <p>where:</p> <p>M/min = speed (M/min)</p> <p>RPM = revolutions per minute (rev/min)</p> <p>DIA = diameter of drill (mm)</p>
--	--	---





**⚠ WARNING** Tool failure can cause serious injury. To prevent:

- When using holders without support bushing, use a short T-A® holder to establish an initial hole that is a minimum of 2 diameters deep.
- Do not rotate tool holder more than 50 RPM unless it is engaged with the workpiece or fixture.

Visit [www.alliedmachine.com/DeepHoleGuidelines](http://www.alliedmachine.com/DeepHoleGuidelines) for the most up-to-date information and procedures. Factory technical assistance is available for your specific applications through our Application Engineering Team.

## Original T-A Recommended Drilling Data | Metric (mm)

HSS Inserts | Flat Bottom Geometry

ISO	Material	Hardness (BHN)	HSS Grade	M/min			
				 TiN	 TiAlN	 TiCN	 AM200®
P	Free Machining Steel 1118, 1215, 12L14, etc.	100 - 150	HSS	52	76	70	88
		150 - 200	HSS	47	70	62	81
		200 - 250	HSS	43	64	56	74
	Low Carbon Steel 1010, 1020, 1025, 1522, 1144, etc.	85 - 125	HSS	46	67	59	77
		125 - 175	HSS	43	64	56	74
		175 - 225	HSS	40	59	53	68
		225 - 275	HSS	37	56	47	65
	Medium Carbon Steel 1030, 1040, 1050, 1527, 1140, 1151, etc.	125 - 175	HSS	43	64	56	74
		175 - 225	HSS	40	59	53	68
		225 - 275	HSS	37	56	47	65
		275 - 325	SC	34	53	46	61
	Alloy Steel 4140, 5140, 8640, etc.	125 - 175	HSS	40	56	53	65
175 - 225		HSS	37	53	47	61	
225 - 275		HSS	34	47	44	54	
275 - 325		SC	32	44	41	51	
High Strength Alloy 4340, 4330V, 300M, etc.	225 - 300	SC	21	29	26	33	
	300 - 350	SC	15	23	21	27	
	350 - 400	SC	13	20	18	23	
Structural Steel A36, A285, A516, etc.	100 - 150	HSS	36	52	47	60	
	150 - 250	HSS	32	44	41	51	
	250 - 350	SC	26	37	34	43	
Tool Steel H-13, H-21, A-4, O-2, S-3, etc.	150 - 200	SC	21	29	27	33	
	200 - 250	SC	15	24	23	28	
S	High Temp Alloy Hastelloy B, Inconel 600, etc.	140 - 220	SC	7	10	9	13
		220 - 310	SC	6	9	7	10
	Titanium Alloy	140 - 220	SC	10	14	12	16
		220 - 310	SC	8	12	11	14
Aerospace Alloy S82	185 - 275	SC	20	27	26	34	
	275 - 350	SC	15	24	21	28	
M	Stainless Steel 400 Series 416, 420, etc.	185 - 275	SC	20	27	26	34
		275 - 350	SC	15	24	21	28
	Stainless Steel 300 Series 304, 316, 17-4PH, etc.	135 - 185	SC	20	27	26	34
		185 - 275	SC	15	24	21	28
	Super Duplex Stainless Steel	135 - 185	SC	20	27	26	34
185 - 275	SC	15	24	21	28		
H	Wear Plate Hardox, AR400, T-1, etc.	400	SC	-	-	-	-
		500	SC	-	-	-	-
		600	N/A	-	-	-	-
	Hardened Steel	300 - 400	SC	13	20	18	24
400 - 500		SC	8	12	10	13	
K	Nodular, Grey, Ductile Cast Iron	120 - 150	HSS	46	67	59	77
		150 - 200	HSS	40	59	53	68
		200 - 220	HSS	34	53	46	61
		220 - 260	SC	29	46	38	53
		260 - 320	SC	24	37	32	43
N	Cast Aluminum	30	HSS	160	228	198	-
		180	HSS	79	122	107	-
	Wrought Aluminum	30	HSS	160	228	198	261
		180	HSS	79	122	107	141
	Aluminum Bronze	100 - 200	SC	40	59	53	70
		200 - 250	SC	29	46	38	50
Brass	100	HSS	46	67	59	78	
Copper	60	SC	35	45	40	53	

❖ Contact our Application Engineering department for assistance when machining these materials

**IMPORTANT:** The speeds and feeds listed above are a general starting point for all applications. Refer to the Coolant Recommendation charts for coolant requirements to run at the recommended speeds and feeds. Factory technical assistance is available through our Application Engineering department. See adjustment examples on the following page.

Feed Rate (mm/rev) by Diameter					
9.50 - 12.95	12.98 - 17.53	17.53 - 24.38	24.21 - 35.00	35.01 - 47.80	47.85 - 65.99
0.15	0.23	0.28	0.35	0.41	0.46
0.15	0.23	0.28	0.35	0.41	0.46
0.13	0.23	0.28	0.35	0.38	0.43
0.13 ❖	0.20	0.25	0.33	0.38	0.43
0.13 ❖	0.20	0.25	0.33	0.38	0.41
0.10 ❖	0.18	0.23	0.30	0.36	0.41
0.10 ❖	0.18	0.23	0.30	0.36	0.38
0.13	0.20	0.25	0.33	0.38	0.46
0.10	0.18	0.23	0.30	0.36	0.43
0.10	0.18	0.23	0.30	0.36	0.43
0.10	0.15	0.20	0.25	0.33	0.38
0.13	0.18	0.23	0.30	0.33	0.41
0.10	0.18	0.23	0.30	0.33	0.41
0.10	0.15	0.23	0.30	0.33	0.41
0.10	0.13	0.20	0.25	0.30	0.38
0.08	0.13	0.20	0.25	0.30	0.36
0.10 ❖	0.15	0.20	0.23	0.25	0.30
0.08 ❖	0.15	0.20	0.23	0.25	0.30
0.08 ❖	0.13	0.18	0.20	0.23	0.28
0.13 ❖	0.23	0.25	0.30	0.38	0.43
0.10 ❖	0.20	0.23	0.25	0.33	0.41
0.10 ❖	0.18	0.20	0.23	0.30	0.38
0.10	0.13	0.18	0.23	0.25	0.30
0.10	0.13	0.18	0.23	0.23	0.28
0.08 ❖	0.15	0.18	0.23	0.25	0.30
0.08 ❖	0.13	0.15	0.18	0.20	0.25
0.08 ❖	0.15	0.18	0.23	0.25	0.30
0.08 ❖	0.13	0.15	0.18	0.20	0.25
0.13 ❖	0.18	0.20	0.25	0.30	0.38
0.10 ❖	0.15	0.18	0.23	0.25	0.30
0.13 ❖	0.18	0.20	0.25	0.30	0.36
0.10 ❖	0.15	0.18	0.23	0.25	0.28
0.13 ❖	0.18	0.20	0.25	0.30	0.36
0.10 ❖	0.15	0.18	0.23	0.25	0.28
-	-	-	-	-	-
-	-	-	-	-	-
-	-	-	-	-	-
0.08 ❖	0.13	0.18	0.20	0.27	0.38
0.06 ❖	0.10	0.15	0.18	0.23	0.28
0.15	0.25	0.36	0.43	0.48	0.51
0.13	0.23	0.30	0.41	0.46	0.48
0.13	0.20	0.25	0.36	0.41	0.43
0.10	0.15	0.20	0.25	0.33	0.33
0.10	0.13	0.15	0.20	0.25	0.25
0.18	0.28	0.36	0.43	0.46	0.48
0.18	0.28	0.36	0.41	0.43	0.48
0.18	0.28	0.36	0.43	0.46	0.48
0.18	0.28	0.36	0.41	0.43	0.48
0.13	0.23	0.30	0.41	0.51	0.61
0.10	0.15	0.20	0.25	0.31	0.38
0.15	0.25	0.36	0.43	0.53	0.63
0.05 ❖	0.08	0.15	0.20	0.25	0.35

Deep Hole Drilling Speed and Feed Adjustment

	Holder Length				
	Extended	Long	Long Plus	XL	3XL
Speed	0.90	0.85	0.80	0.80	0.75
Feed	-	0.95	0.90	0.90	0.90

Recommended Speed and Feed Example

If the recommended speed and feed is 50 M/min and 0.20 mm/rev for a standard length holder, then the speed and feed using a 3XL holder in the same application would be 37.5 M/min and 0.18 mm/rev.

$50 \cdot 0.75 = 37.5 \text{ M/min}$        $0.20 \cdot 0.90 = 0.18 \text{ mm/rev}$

Formulas

- RPM = (318.47 • M/min) / DIA**

where:  
 RPM = revolutions per minute (rev/min)  
 M/min = speed (M/min)  
 DIA = diameter of drill (mm)
- mm/min = RPM • mm/rev**





where:  
 mm/min = mm per minute (mm/min)  
 RPM = revolutions per minute (rev/min)  
 mm/rev = feed rate (mm/rev)
- M/min = RPM • 0.003 • DIA**

where:  
 M/min = speed (M/min)  
 RPM = revolutions per minute (rev/min)  
 DIA = diameter of drill (mm)

**⚠ WARNING** Tool failure can cause serious injury. To prevent:  
 - When using holders without support bushing, use a short T-A® holder to establish an initial hole that is a minimum of 2 diameters deep.  
 - Do not rotate tool holder more than 50 RPM unless it is engaged with the workpiece or fixture.  
 Visit [www.alliedmachine.com/DeepHoleGuidelines](http://www.alliedmachine.com/DeepHoleGuidelines) for the most up-to-date information and procedures. Factory technical assistance is available for your specific applications through our Application Engineering Team.





## Original T-A Recommended Drilling Data | Metric (mm)

Carbide Inserts | Flat Bottom Geometry

ISO	Material	Hardness (BHN)	Carbide Grade	M/min				Feed Rate (mm/rev) by Diameter			
				 TiN	 TiAlN	 TiCN	 AM200®	9.50 - 12.95	12.98 - 17.53	17.54 - 24.38	24.41 - 35.00
P	<b>Free Machining Steel</b> 1118, 1215, 12L14, etc.	100 - 150	C2	82	110	98	126	0.17	0.26	0.32	0.39
		150 - 200	C2	73	94	85	110	0.15	0.24	0.30	0.35
		200 - 250	C2	67	88	76	102	0.13	0.22	0.28	0.32
	<b>Low Carbon Steel</b> 1010, 1020, 1025, 1522, 1144, etc.	85 - 125	C2	79	102	94	117	0.17 ❖	0.22	0.28	0.37
		125 - 175	C2	67	88	76	102	0.15 ❖	0.22	0.28	0.35
		175 - 225	C2	61	81	70	93	0.13 ❖	0.19	0.26	0.32
	<b>Medium Carbon Steel</b> 1030, 1040, 1050, 1527, 1140, 1151, etc.	225 - 275	C2	55	70	64	81	0.11 ❖	0.19	0.26	0.32
		125 - 175	C2	67	88	76	102	0.15	0.22	0.28	0.35
		175 - 225	C2	61	81	72	93	0.13	0.19	0.26	0.32
	<b>Alloy Steel</b> 4140, 5140, 8640, etc.	225 - 275	C2	55	70	61	81	0.13	0.19	0.26	0.32
		275 - 325	C2	46	61	53	70	0.11	0.17	0.24	0.30
		125 - 175	C2	64	85	75	99	0.15	0.22	0.28	0.35
175 - 225		C2	59	79	67	91	0.13	0.19	0.26	0.32	
225 - 275		C2	55	70	61	81	0.13	0.19	0.26	0.32	
<b>High Strength Alloy</b> 4340, 4330V, 300M, etc.	275 - 325	C2	44	58	50	67	0.09	0.15	0.22	0.28	
	225 - 300	C2	41	52	47	59	0.13 ❖	0.19	0.22	0.26	
	300 - 350	C2	37	47	41	55	0.11 ❖	0.17	0.19	0.24	
<b>Structural Steel</b> A36, A285, A516, etc.	350 - 400	C2	30	41	37	47	0.09 ❖	0.15	0.17	0.22	
	100 - 150	C2	62	81	72	93	0.17 ❖	0.24	0.30	0.35	
	150 - 250	C2	52	66	58	76	0.13 ❖	0.22	0.28	0.30	
<b>Tool Steel</b> H-13, H-21, A-4, O-2, S-3, etc.	250 - 350	C2	47	61	53	70	0.11 ❖	0.19	0.25	0.26	
	150 - 200	C2	41	58	49	67	0.09	0.15	0.19	0.24	
	200 - 250	C2	30	44	37	50	0.09	0.15	0.19	0.24	
	<b>High Temp Alloy</b> Hastelloy B, Inconel 600, etc.	140 - 220	C2	21	27	23	32	0.09 ❖	0.15	0.19	0.24
220 - 310		C2	15	21	18	24	0.09 ❖	0.13	0.17	0.22	
<b>Titanium Alloy</b>		140 - 220	C2	26	33	28	40	0.08 ❖	0.14	0.17	0.20
		220 - 310	C2	21	29	25	30	0.08 ❖	0.12	0.15	0.18
<b>Aerospace Alloy</b> S82	185 - 275	C2	43	37	50	40	0.15 ❖	0.17	0.25	0.30	
	275 - 350	C2	33	28	38	32	0.13 ❖	0.15	0.23	0.25	
<b>M</b>	<b>Stainless Steel 400 Series</b> 416, 420, etc.	185 - 275	C2	43	56	50	64	0.15 ❖	0.20	0.25	0.30
		275 - 350	C2	33	43	38	49	0.13 ❖	0.18	0.23	0.25
	<b>Stainless Steel 300 Series</b> 304, 316, 17-4PH, etc.	135 - 185	C2	28	37	33	40	0.13 ❖	0.17	0.21	0.25
		185 - 275	C2	21	28	25	32	0.11 ❖	0.15	0.19	0.21
	<b>Super Duplex Stainless Steel</b>	135 - 185	C2	22	29	26	33	0.10 ❖	0.14	0.17	0.20
185 - 275		C2	17	22	19	26	0.08 ❖	0.12	0.15	0.17	

❖ Contact our Application Engineering department for assistance when machining these materials

**IMPORTANT:** The speeds and feeds listed above are a general starting point for all applications. Refer to the Coolant Recommendation charts for coolant requirements to run at the recommended speeds and feeds. Factory technical assistance is available through our Application Engineering department. See adjustment examples on the following page.

ISO	Material	Hardness (BHN)	Carbide Grade	M/min				Feed Rate (mm/rev) by Diameter			
				 TiN	 TiAlN	 TiCN	 AM200®	9.50 - 12.95	12.98 - 17.53	17.54 - 24.38	24.41 - 35.00
H	Wear Plate Hardox, AR400, T-1, etc.	400	C2	20	31	26	39	0.06 ❖	0.10	0.16	0.20
		500	C2	13	23	18	31	0.04 ❖	0.08	0.12	0.16
		600	C2	10	19	14	25	0.03 ❖	0.06	0.10	0.13
	Hardened Steel	300 - 400	C2	30	38	34	41	0.08 ❖	0.14	0.18	0.22
400 - 500		C2	18	22	20	33	0.06 ❖	0.12	0.16	0.18	
K	Nodular, Grey, Ductile Cast Iron	120 - 150	C2	82	120	108	137	0.17	0.26	0.32	0.41
		150 - 200	C2	70	104	87	119	0.15	0.24	0.28	0.38
		200 - 220	C2	61	94	79	108	0.13	0.19	0.26	0.32
		220 - 260	C2	55	81	67	93	0.11	0.17	0.24	0.28
		260 - 320	C2	47	70	58	81	0.11	0.15	0.22	0.24
N	Cast Aluminum	30	C2	160	228	198	-	0.22	0.32	0.41	0.43
		180	C2	79	122	107	-	0.19	0.28	0.35	0.39
	Wrought Aluminum	30	C2	292	368	328	390	0.12	0.18	0.23	0.25
		180	C2	195	245	220	260	0.10	0.16	0.20	0.22
	Aluminum Bronze	100 - 200	C2	73	95	85	105	0.10	0.16	0.20	0.29
		200 - 250	C2	55	81	68	87	0.08	0.12	0.14	0.20
	Brass	100	C2	112	160	138	185	0.12	0.18	0.22	0.30
Copper	60	C2	68	105	85	117	0.04 ❖	0.06	0.08	0.12	

❖ Contact our Application Engineering department for assistance when machining these materials

**Deep Hole Drilling Speed and Feed Adjustment**

	⚠ Holder Length				
	Extended	Long	Long Plus	XL	3XL
Speed	0.90	0.85	0.80	0.80	0.75
Feed	-	0.95	0.90	0.90	0.90

**Recommended Speed and Feed Example**

If the recommended speed and feed is 50 M/min and 0.20 mm/rev for a standard length holder, then the speed and feed using a 3XL holder in the same application would be 37.5 M/min and 0.18 mm/rev.

$50 \cdot 0.75 = 37.5 \text{ M/min}$	$0.20 \cdot 0.90 = 0.18 \text{ mm/rev}$
--------------------------------------	---

**Formulas**

1. $RPM = (318.47 \cdot M/min) / DIA$ where: RPM = revolutions per minute (rev/min) M/min = speed (M/min) DIA = diameter of drill (mm)	2. $mm/min = RPM \cdot mm/rev$ where: mm/min = mm per minute (mm/min) RPM = revolutions per minute (rev/min) mm/rev = feed rate (mm/rev)	3. $M/min = RPM \cdot 0.003 \cdot DIA$ where: M/min = speed (M/min) RPM = revolutions per minute (rev/min) DIA = diameter of drill (mm)
--	--	---

**⚠ WARNING** Tool failure can cause serious injury. To prevent:

- When using holders without support bushing, use a short T-A® holder to establish an initial hole that is a minimum of 2 diameters deep.
- Do not rotate tool holder more than 50 RPM unless it is engaged with the workpiece or fixture.

Visit [www.alliedmachine.com/DeepHoleGuidelines](http://www.alliedmachine.com/DeepHoleGuidelines) for the most up-to-date information and procedures. Factory technical assistance is available for your specific applications through our Application Engineering Team.

## Original T-A Recommended Drilling Data | Metric (mm)

Carbide Inserts | Diamond Coating

Material	Carbide Grade	M/min  Diamond Coating	Feed Rate (mm/rev) by Diameter				
			9.5 - 12.5	13 - 17.5	18 - 24	25 - 35	
Polymer Matrix Composites	Carbon (hard)	N2	305 - 450	0.10 - 0.15	0.20 - 0.25	0.25 - 0.30	0.30 - 0.36
	Carbon Fiber	N2	305 - 450	0.10 - 0.15	0.20 - 0.25	0.25 - 0.30	0.30 - 0.36
	Carbon / Glass Fiber	N2	305 - 450	0.10 - 0.15	0.20 - 0.25	0.25 - 0.30	0.30 - 0.36
	Fiberglass	N2	305 - 450	0.10 - 0.15	0.20 - 0.25	0.25 - 0.30	0.30 - 0.36
	Graphite	N2	305 - 450	0.10 - 0.15	0.20 - 0.25	0.25 - 0.30	0.30 - 0.36
	Plastics	N2	76 - 305	0.10 - 0.15	0.20 - 0.25	0.25 - 0.30	0.30 - 0.36
	Epoxy Resin	N2	76 - 305	0.10 - 0.15	0.20 - 0.25	0.25 - 0.30	0.30 - 0.36
	Bismaleimide Resin	N2	76 - 305	0.10 - 0.15	0.20 - 0.25	0.25 - 0.30	0.30 - 0.36
	Polyester Resin	N2	76 - 305	0.10 - 0.15	0.20 - 0.25	0.25 - 0.30	0.30 - 0.36
	Phenolic Resin	N2	76 - 305	0.10 - 0.15	0.20 - 0.25	0.25 - 0.30	0.30 - 0.36
Rubber	N2	76 - 305	0.10 - 0.15	0.20 - 0.25	0.25 - 0.30	0.30 - 0.36	
Metal Matrix Composites	Aluminum	N2	305	0.20	0.33	0.41	0.51
	Si < 10%	N2	305	0.20	0.33	0.41	0.51
	10% < Si < 15%	N2	259 - 305	0.20	0.33	0.41	0.51
	15% < Si < 20%	N2	198 - 259	0.20	0.33	0.41	0.51
	20% < Si < 25%	N2	152 - 198	0.20	0.33	0.41	0.51
	25% < Si	N2	61 - 152	0.20	0.33	0.41	0.51
	Brass	N2	76 - 152	0.20	0.33	0.41	0.51
	Bronze	N2	76 - 152	0.20	0.33	0.41	0.51
	Copper	N2	30 - 76	0.10 - 0.15	0.20 - 0.25	0.25 - 0.30	0.30 - 0.36
	Copper Alloys	N2	30 - 76	0.10 - 0.15	0.20 - 0.25	0.25 - 0.30	0.30 - 0.36
	Lead Alloys	N2	30 - 76	0.10 - 0.15	0.20 - 0.25	0.25 - 0.30	0.30 - 0.36
	Magnesium Alloys	N2	30 - 76	0.10 - 0.15	0.20 - 0.25	0.25 - 0.30	0.30 - 0.36
	Precious Metals	N2	30 - 76	0.10 - 0.15	0.20 - 0.25	0.25 - 0.30	0.30 - 0.36
Ceramic Matrix Composites	Carbide (green)	N2	15 - 76	0.10 - 0.15	0.20 - 0.25	0.25 - 0.30	0.30 - 0.36
	Ceramic (green)	N2	15 - 76	0.10 - 0.15	0.20 - 0.25	0.25 - 0.30	0.30 - 0.36
	Ceramic (pre-sintered)	N2	15 - 76	0.10 - 0.15	0.20 - 0.25	0.25 - 0.30	0.30 - 0.36

### Deep Hole Drilling Speed and Feed Adjustment

	Holder Length				
	Extended	Long	Long Plus	XL	3XL
Speed	0.90	0.85	0.80	0.80	0.75
Feed	-	0.95	0.90	0.90	0.90

### Recommended Speed and Feed Example

If the recommended speed and feed is 50 M/min and 0.20 mm/rev for a standard length holder, then the speed and feed using a 3XL holder in the same application would be 37.5 M/min and 0.18 mm/rev.

$$50 \cdot 0.75 = 37.5 \text{ M/min}$$

$$0.20 \cdot 0.90 = 0.18 \text{ mm/rev}$$

#### **⚠ WARNING** Tool failure can cause serious injury. To prevent:

- When using holders without support bushing, use a short T-A® holder to establish an initial hole that is a minimum of 2 diameters deep.
- Do not rotate tool holder more than 50 RPM unless it is engaged with the workpiece or fixture.

Visit [www.alliedmachine.com/DeepHoleGuidelines](http://www.alliedmachine.com/DeepHoleGuidelines) for the most up-to-date information and procedures. Factory technical assistance is available for your specific applications through our Application Engineering Team.

**IMPORTANT:** The speeds and feeds listed above are a general starting point for all applications. Refer to the Coolant Recommendation charts for coolant requirements to run at the recommended speeds and feeds. Factory technical assistance is available through our Application Engineering department. See adjustment examples on the following page.



## Tap Drill Information and Formulas | Metric (mm)

### Metric Profile Screw Thread

Tap Size	Tap Drill Size	Decimal Equivalent	* Theo % Thread	Probable Mean Oversize	Probable Hole Size	** Probable % Thread
12 x 1.75	10.2mm	0.4016"	79%	0.075mm	10.28mm	76%
12 x 1.75	13/32"	0.4063"	74%	0.075mm	10.40mm	71%
12 x 1.25	27/64"	0.4219"	79%	0.075mm	10.79mm	74%
12 x 1.25	10.8mm	0.4252"	74%	0.075mm	10.88mm	69%
14 x 20	15/32"	0.4688"	81%	0.075mm	11.98mm	78%
14 x 20	12.0mm	0.4724"	77%	0.075mm	12.08mm	74%
14 x 1.5	12.5mm	0.4921"	77%	0.075mm	12.58mm	73%
16 x 2.0	14.0mm	0.5512"	77%	0.075mm	14.08mm	74%
16 x 1.5	14.5mm	0.5709"	77%	0.075mm	14.58mm	73%
16 x 1.5	37/64"	0.5781"	68%	0.075mm	14.76mm	64%
18 x 2.5	15.5mm	0.6102"	77%	0.075mm	15.58mm	75%
18 x 1.5	16.5mm	0.6496"	77%	0.075mm	16.58mm	73%
18 x 1.5	21/32"	0.6563"	68%	0.075mm	16.75mm	64%
20 x 2.5	11/16"	0.6875"	78%	0.075mm	17.54mm	76%
20 x 2.5	17.5mm	0.6890"	77%	0.075mm	17.58mm	74%
20 x 1.5	18.5mm	0.7283"	77%	0.075mm	18.58mm	73%
20 x 1.5	47/64"	0.7344"	69%	0.075mm	18.66mm	65%
22 x 2.5	49/64"	0.7656"	79%	0.075mm	19.52mm	76%
22 x 2.5	19.5mm	0.7677"	77%	0.075mm	19.58mm	75%
22 x 1.5	20.5mm	0.8071"	77%	0.075mm	20.58mm	73%
22 x 1.5	13/16"	0.8125"	70%	0.075mm	20.71mm	66%
24 x 3	13/16"	0.8125"	86%	0.075mm	20.71mm	84%
24 x 3	21.0mm	0.8268"	76%	0.075mm	21.08mm	75%
24 x 2	22.0mm	0.8661"	77%	0.075mm	22.08mm	74%
24 x 2	7/8"	0.8750"	68%	0.075mm	22.30mm	65%
27 x 3	24.0mm	0.9449"	77%	0.075mm	24.08mm	75%

### Taper Pipe Thread (NPT)

Tap Size	Tap Drill Size	Decimal Equivalent	Theo % Thread*	Probable Mean Oversize	Probable Hole Size	Probable % Thread**
1/4 - 18	7/16	0.4375	-	0.075mm	11.19mm	-
3/8 - 18	9/16	0.5625	-	0.075mm	14.76mm	-
1/2 - 14	45/64	0.7031	-	0.075mm	18.33mm	-
3/4 - 14	29/32	0.9063	-	0.075mm	23.89mm	-

\* Based on nominal tap drill diameter

\*\* Based on .003" probable mean oversize

To calculate the percent of full thread for a given hole diameter:

$$\% \text{ Thread} = \left[ \frac{76.93}{\text{Pitch (mm)}} \right] \left[ \text{Basic Major Diameter of Thread (mm)} - \text{Drill Hole Size (mm)} \right]$$

### Notes

- The above tap drill information represents probable thread percentages for the standard tap drills stocked at Allied Machine. Special insert diameters may be required in order to meet a user specific percentage of thread requirements.
- The .003 probable mean oversize hole condition is based on optimum cutting conditions. Probable percent of full thread may vary based on less ideal cutting conditions.
- The table and equations on this page are found in the *Machinery's Handbook*. Permission to simplify and print the equations is granted by the Editor of the *Machinery's Handbook*.

### Formulas

1.	<b>RPM</b> = (318.47 • M/min) / DIA
	where: RPM = revolutions per minute (rev/min) M/min = speed (M/min) DIA = diameter of drill (mm)
2.	<b>mm/min</b> = RPM • mm/rev
	where: mm/min = mm per minute (mm/min) RPM = revolutions per minute (rev/min) mm/rev = feed rate (mm/rev)
3.	<b>M/min</b> = RPM • 0.003 • DIA
	where: M/min = speed (M/min) RPM = revolutions per minute (rev/min) DIA = diameter of drill (mm)
4.	<b>Thrust</b> = 154 • (mm/rev) • DIA • K <sub>m</sub>
	where: Thrust = axial thrust (N) mm/rev = feed rate (mm/rev) DIA = diameter of drill (mm) K <sub>m</sub> = specific cutting energy (bar)
5.	<b>Tool Power</b> = ((mm/rev) • RPM • K <sub>m</sub> • DIA <sup>2</sup> ) / 210604.8
	where: Tool Power = tool power (HP) mm/rev = feed rate (mm/rev) RPM = revolutions per minute (rev/min) K <sub>m</sub> = specific cutting energy (bar) DIA = diameter of drill (mm)

### Material Constants

Type of Material	Hardness	K <sub>m</sub> (kPa)
Plain Carbon and Alloy Steel	85 - 200 BHN	5.45
	200 - 275 BHN	6.48
	275 - 375 BHN	6.89
	375 - 425 BHN	7.93
High Temperature Alloys	-	9.93
Stainless Steels	135 - 275 BHN	6.48
	30 - 45 RC	7.45
Cast Iron	100 - 200 BHN	3.45
	200 - 300 BHN	7.45
Copper Alloy	20 - 80 RB	2.96
	80 - 100 RB	4.96
Titanium Alloy	-	4.96
Aluminum Alloy	-	1.52
Magnesium Alloy	-	1.10

## Coolant Recommendations | Metric (mm)

### HSS Drill Inserts

ISO	Material	Pressure or Flow Rate	9.5 - 12.5	13 - 17	18 - 24	25 - 35	36 - 50	51 - 76	76 - 102
P	Free Machining Steel 1118, 1215, 12L14, etc.	BAR	12 - 13	7 - 8	7 - 10	6 - 8	5 - 7	4	5 - 6
		LPM	9.5 - 9.8	10.6 - 11.4	16.7 - 19.7	26.5 - 30.3	45.4 - 53.0	114 - 125	144 - 167
	Low Carbon Steel 1010, 1020, 1025, 1522, 1144, etc.	BAR	11 - 12	5 - 6	5 - 7	4 - 6	4 - 5	2 - 3	3 - 5
		LPM	9.1 - 9.5	9.1 - 9.8	14.0 - 15.9	22.7 - 26.5	41.6 - 45.4	98 - 114	125 - 144
	Medium Carbon Steel 1030, 1040, 1050, 1527, 1140, 1151, etc.	BAR	11	5 - 6	5 - 6	4 - 5	3 - 5	2 - 3	3 - 5
		LPM	8.7 - 9.1	8.7 - 9.8	13.6 - 15.5	18.9 - 22.7	37.9 - 45.4	98 - 114	125 - 144
	Alloy Steel 4140, 5140, 8640, etc.	BAR	11	5	5 - 6	3 - 5	3 - 4	2	3
		LPM	8.7 - 9.1	8.3 - 9.1	13.2 - 14.8	18.9 - 22.7	31.9 - 41.6	98 - 106	114 - 125
	High Strength Alloy 4340, 4330V, 300M, etc.	BAR	10 - 11	4	3	2	2	1 - 2	2
		LPM	8.7 - 9.1	7.9 - 8.3	11.0 - 11.7	15.1 - 18.9	26.5 - 30.3	79 - 87	87 - 98
	Structural Steel A36, A285, A516, etc.	BAR	11	5 - 6	5 - 6	3 - 4	3	2	3
		LPM	8.7 - 9.1	9.1 - 9.8	13.2 - 14.8	18.9 - 22.7	34.1 - 37.9	87 - 98	114 - 125
Tool Steel H-13, H-21, A-4, O-2, S-3, etc.	BAR	10 - 11	4	3	2	2	1 - 2	2	
	LPM	8.7 - 9.1	7.9 - 8.3	11.0 - 11.7	15.1 - 18.9	26.5 - 30.3	79 - 87	87 - 98	
S	High Temp Alloy Hastelloy B, Inconel 600, etc.	BAR	10 - 11	4 - 5	3 - 4	2	2	2	3
		LPM	8.7 - 9.1	8.3 - 8.7	11.7 - 12.1	15.1 - 18.9	26.5 - 30.3	87 - 98	125
	Titanium Alloy	BAR	10 - 11	4 - 5	3 - 4	2	2	2	3
		LPM	8.7 - 9.1	8.3 - 8.7	11.7 - 12.1	15.1 - 18.9	26.5 - 30.3	87 - 98	125
Aerospace Alloy S82	BAR	10 - 11	4 - 5	3 - 4	2	2	2	3	
	LPM	8.7 - 9.1	8.3 - 8.7	11.7 - 12.1	15.1 - 18.9	26.5 - 30.3	87 - 98	125	
M	Stainless Steel 400 Series 416, 420, etc.	BAR	11.8	5.9	5.2	3.8	3.5	2	3.1
		LPM	9.5	9.8	14	23	38	98	117
	Stainless Steel 300 Series 304, 316, 17-4PH, etc.	BAR	11.8	5.9	5.2	3.8	3.5	2	3.1
		LPM	9.5	9.8	14	23	38	98	117
	Super Duplex Stainless Steel	BAR	11.8	5.9	5.2	3.8	3.5	2	3.1
		LPM	9.5	9.8	14	23	38	98	117
H	Wear Plate Hardox, AR400, T-1, etc.	BAR	10.7	4.2	3.5	2	2	1.7	2
		LPM	9.1	8.3	11.7	19	30	87	98
	Hardened Steel	BAR	10.7	4.2	3.5	2	2	1.7	2
		LPM	9.1	8.3	11.7	19	30	87	98
K	SG / Nodular Cast Iron	BAR	11	4.5	4.2	2.8	2.4	2	2.4
		LPM	9.1	8.7	12.5	19	34	98	106
	Grey / White Iron	BAR	11	4.5	4.2	2.8	2.4	2	2.4
		LPM	9.1	8.7	12.5	19	34	98	106
N	Cast Aluminum	BAR	14.5	12.4	15.8	11	8.6	3.5	5.5
		LPM	10	14	23	34	61	125	159
	Wrought Aluminum	BAR	14.5	12.4	15.8	11	8.6	3.5	5.5
		LPM	10	14	23	34	61	125	159
	Aluminum Bronze	BAR	12.8	8.3	9.65	7.95	6.9	3.5	6.2
		LPM	9.6	11.4	19.7	30.3	53	125	167
	Brass	BAR	11	4.5	4.2	2.8	2.4	2	2.4
		LPM	9.1	8.7	12.5	19	34	98	106
	Copper	BAR	12.8	8.3	9.65	7.95	6.9	3.5	6.2
		LPM	9.6	11.4	19.7	30.3	53	125	167

#### Deep Hole Drilling Coolant Adjustment

	Holder Length				
	Extended	Long	Long Plus	XL	3XL
Pressure and Flow	1.3	1.5	2	2	3

#### Recommended Coolant Example

If the recommended pressure and flow is 12 bar and 22 LPM for a standard length holder, then the adjusted pressure and flow for a 3XL holder would be 36 bar and 66 LPM.

$$12 \cdot 3 = 36 \text{ bar} \quad 22 \cdot 3 = 66 \text{ LPM}$$

#### WARNING Tool failure can cause serious injury. To prevent:

- When using holders without support bushing, use a short T-A® holder to establish an initial hole that is a minimum of 2 diameters deep.
- Do not rotate tool holder more than 50 RPM unless it is engaged with the workpiece or fixture.

Visit [www.alliedmachine.com/DeepHoleGuidelines](http://www.alliedmachine.com/DeepHoleGuidelines) for the most up-to-date information and procedures. Factory technical assistance is available for your specific applications through our Application Engineering Team.

**IMPORTANT:** The coolant pressure and flow rate recommendations above represent a good approximation to obtain optimum tool life and chip evacuation at Allied Machine recommended speeds and feeds. If lower coolant capabilities exist in a drilling application, the T-A® drilling system will still function at reduced penetration rates. Contact our Application Engineering department for a more specific recommendation of coolant requirements and/or speeds and feeds.

## Coolant Recommendations | Metric (mm)

### Carbide Drill Inserts

ISO	Material	Pressure or Flow Rate	9.5 - 12.5	13 - 17	18 - 24	25 - 35	36 - 47
P	Free Machining Steel 1118, 1215, 12L14, etc.	BAR	17 - 20	17	15	15	20
		LPM	12.2	16.3	25.2	41.5	71.9
	Low Carbon Steel 1010, 1020, 1025, 1522, 1144, etc.	BAR	18	11	11	12	9
		LPM	11.4	13.3	20.6	36.5	62.0
	Medium Carbon Steel 1030, 1040, 1050, 1527, 1140, 1151, etc.	BAR	17	10	10	10	8
		LPM	11.3	12.5	20.0	33.8	57.0
	Alloy Steel 4140, 5140, 8640, etc.	BAR	17	9	10	8	7
		LPM	11.1	12.3	19.3	30.0	55.8
	High Strength Alloy 4340, 4330V, 300M, etc.	BAR	15	5	4	3	3
		LPM	10.4	9.1	12.6	18.8	33.6
Structural Steel A36, A285, A516, etc.	BAR	16	9	8	7	5	
	LPM	10.8	12.0	17.5	27.8	47.1	
Tool Steel H-13, H-21, A-4, O-2, S-3, etc.	BAR	15	5	5	3	3	
	LPM	10.4	9.1	13.6	19.7	36.5	
S	High Temp Alloy Hastelloy B, Inconel 600, etc.	BAR	17	11	12	11	9
		LPM	11.1	13.5	21.9	35.4	62.0
	Titanium Alloy	BAR	17	11	12	11	9
		LPM	11.1	13.5	21.9	35.4	62.0
Aerospace Alloy S82	BAR	17	11	12	11	9	
	LPM	11.1	13.5	21.9	35.4	62.0	
M	Stainless Steel 400 Series 416, 420, etc.	BAR	22.7	16.5	17.9	17.2	13.1
		LPM	13	16.3	26.3	44.2	75
	Stainless Steel 300 Series 304, 316, 17-4PH, etc.	BAR	22.7	16.5	17.9	17.2	13.1
		LPM	13	16.3	26.3	44.2	75
Super Duplex Stainless Steel	BAR	22.7	16.5	17.9	17.2	13.1	
	LPM	13	16.3	26.3	44.2	75	
H	Wear Plate Hardox, AR400, T-1, etc.	BAR	14.5	5.2	4.8	3.4	3.1
		LPM	10.4	9.1	13.6	19.7	36.5
	Hardened Steel	BAR	14.5	5.2	4.8	3.4	3.1
		LPM	10.4	9.1	13.6	19.7	36.5
K	SG / Nodular Cast Iron	BAR	15.5	7.2	6.2	6.2	5.5
		LPM	10.7	10.8	15.4	26.5	48.7
	Grey / White Iron	BAR	15.5	7.2	6.2	6.2	5.5
		LPM	10.7	10.8	15.4	26.5	48.7
N	Cast Aluminum	BAR	24.1	22	21.7	19.6	13.8
		LPM	13.4	18.8	29	47.2	77
	Wrought Aluminum	BAR	24.1	22	21.7	19.6	13.8
		LPM	13.4	18.8	29	47.2	77
	Aluminum Bronze	BAR	20	16.5	16.5	15.2	12
		LPM	12.2	16.3	25.2	41.5	71.9
	Brass	BAR	24.1	22	21.7	19.6	13.8
		LPM	13.4	18.8	29	47.2	77
Copper	BAR	20	16.5	16.5	15.2	12	
	LPM	12.2	16.3	25.2	41.5	71.9	

#### Deep Hole Drilling Coolant Adjustment

	Holder Length				
	Extended	Long	Long Plus	XL	3XL
Pressure and Flow	1.3	1.5	2	2	3

#### Recommended Coolant Example

If the recommended pressure and flow is 12 bar and 22 LPM for a standard length holder, then the adjusted pressure and flow for a 3XL holder would be 36 bar and 66 LPM.

$$12 \cdot 3 = 36 \text{ bar}$$

$$22 \cdot 3 = 66 \text{ LPM}$$

#### ⚠️ WARNING Tool failure can cause serious injury. To prevent:

- When using holders without support bushing, use a short T-A® holder to establish an initial hole that is a minimum of 2 diameters deep.
- Do not rotate tool holder more than 50 RPM unless it is engaged with the workpiece or fixture.

Visit [www.alliedmachine.com/DeepHoleGuidelines](http://www.alliedmachine.com/DeepHoleGuidelines) for the most up-to-date information and procedures. Factory technical assistance is available for your specific applications through our Application Engineering Team.

**IMPORTANT:** The coolant pressure and flow rate recommendations above represent a good approximation to obtain optimum tool life and chip evacuation at Allied Machine recommended speeds and feeds. If lower coolant capabilities exist in a drilling application, the T-A® drilling system will still function at reduced penetration rates. Contact our Application Engineering department for a more specific recommendation of coolant requirements and/or speeds and feeds.

A  
DRILLING  
B  
BORING  
C  
REAMING  
D  
BURNISHING  
E  
THREADING  
X  
SPECIALS

## Troubleshooting Guide

	Potential Problem																						
	Accelerated corner wear	Barber pole	Bell mouth hole	Insert chipping	Blue chips	Build Up Edge (BUE)	Chatter	Chip packing	Chipping of point	Damaged or broken tools	Excessive margin wear	High flank wear	Hole lead off	Hole out of position	Hole out of round	Notching of insert	Oversize hole	Poor hole finish	Poor tool life	Power spikes - Load meter	Retract spiral	Step burned on insert	
Setup Condition	1	2	3	4	5	6	7	8	9	10	11	12	13	14	15	16	17	18	19	20	21	22	Possible Solutions
<p>⚠ Use of Standard, Standard Plus, Extended, Long, Long Plus, XL, and 3XL holders.</p> <p>See page 8 for Deep Hole Drilling guidelines.</p>		2	3				7		9				13	14			17				21		<ul style="list-style-type: none"> <li>Start with short holder and drill a minimum depth equal to 2xD (see page A30: 146 for instructions).</li> <li>Spot hole with stub tool of same or greater included angle as T-A® drill insert.</li> <li>Decrease feed a minimum of 50% until establishing full diameter.</li> <li>Use special holder with wear pads or chrome bearing area to work with drill bushings.</li> </ul>
Starting on an inclined surface.							7		9	10	11		13		15						21		<ul style="list-style-type: none"> <li>Spot face surface to provide a flat entry surface.</li> <li>Spot hole with stub tool of same or greater included angle as T-A® drill insert.</li> <li>Decrease feed a minimum of 50% until establishing full diameter.</li> <li>Use special holder with wear pads or chrome bearing area to work with drill bushings.</li> </ul>
Worn or misaligned spindle (lathe, screw machine, chucker).	1		3				7		9	10	11		13				17	18			21		<ul style="list-style-type: none"> <li>Align spindle and turret or tailstock.</li> <li>Repair spindle.</li> <li>Spot hole with stub tool of same or greater included angle as T-A® drill insert.</li> </ul>
Use of low rigidity machine tools (radial drills, multi-spindle drill press, etc.).		2	3	4			7		9	10			13	14							21		<ul style="list-style-type: none"> <li>Spot hole with stub tool of same or greater included angle as T-A® drill insert.</li> <li>Reduce penetration rate to fall within the physical limits of the machine or setup (<b>NOTICE:</b> Do not reduce feed below threshold of good chip formation).</li> <li>Use special holder with wear pads or chrome bearing area to work with drill bushings.</li> <li>Use tougher tool steel grades with high wear resistant coatings.</li> </ul>
Poor work piece support.		2		4			7			10	11				15				18		21		<ul style="list-style-type: none"> <li>Provide additional support for the work piece.Reduce penetration rate to fall within the physical limits of the machine or setup (<b>NOTICE:</b> Do not reduce feed below threshold of good chip formation).</li> <li>Use tougher tool steel grades with high wear resistant coatings.</li> </ul>
Flood coolant, low coolant pressure or low coolant volume.	1				5	6		8		10		12					17	18	19	20		22	<ul style="list-style-type: none"> <li>Run coolant through tool holder when drilling greater than one times diameter.</li> <li>Increase coolant pressure and volume through the tool holder.</li> <li>Reduce penetration rate to fall within the coolant limitations (<b>NOTICE:</b> Do not reduce feed below threshold of good chip formation).</li> <li>Add a peck cycle to help clear chips.</li> </ul>

**1. WARNING** Tool failure can cause serious injury. To prevent:



- When using holders without support bushing, use a short T-A® holder to establish an initial hole that is a minimum of 2 diameters deep.
- Do not rotate tool holder more than 50 RPM unless it is engaged with the workpiece or fixture.

Visit [www.alliedmachine.com/DeepHoleGuidelines](http://www.alliedmachine.com/DeepHoleGuidelines) for the most up-to-date information and procedures. Factory technical assistance is available for your specific applications through our Application Engineering Team.

	Potential Problem																						Possible Solutions
	Accelerated corner wear	Barber pole	Bell mouth hole	Insert chipping	Blue chips	Build Up Edge (BUE)	Chatter	Chip packing	Chipping of point	Damaged or broken tools	Excessive margin wear	High flank wear	Hole lead off	Hole out of position	Hole out of round	Notching of insert	Oversize hole	Poor hole finish	Poor tool life	Power spikes - Load meter	Retract spiral	Step burned on insert	
Setup Condition	1	2	3	4	5	6	7	8	9	10	11	12	13	14	15	16	17	18	19	20	21	22	
Interrupted cuts. Entry or exit surfaces that are not perpendicular to the spindle (draft angles, stepped surfaces, cross holes, and cast or forged surfaces).				4			7		9	10	11		13	14	15			17	18	19			<ul style="list-style-type: none"> <li>Pre-mill (spot face) entry or exit surface to remove interruption.</li> <li>Spot hole with stub tool of same or greater included angle as T-A® drill insert.</li> <li>Decrease feed as much as 50% through entry or exit interruption.</li> <li>Use short holders in low impact entry cuts.</li> </ul>
Material harder than expected or running tools beyond recommended speeds.	1				5	6				10		12								19		22	<ul style="list-style-type: none"> <li>Reduce speed if a step is worn in the insert, calculate SFM at the worn diameter. Reduce this value by 10% and apply this new value to the original tool diameter.</li> <li>Increase coolant pressure and volume.</li> <li>Improve coolant condition by use of quality products and regular maintenance.</li> <li>Select an insert grade (premium, super cobalt, or carbide) or coating (TiAlN, TiCN, or AM200®) that is more wear and heat resistant.</li> </ul>
Poor material micro-structure or foreign particles (forgings and castings that have not been normalized or annealed, poorly prepared steel, flame cut parts and sand casting).				4		6				10		12	13			16				19			<ul style="list-style-type: none"> <li>Compare performance of other tools for similar wear problems, which may indicate poor micro-structure. Anneal or normalize parts to improve micro-structure for machining.</li> <li>To improve tool life in materials with poor micro-structure, try carbide grades.</li> <li>For hard spots or inclusions, use the tougher insert steel grade with high wear resistant coatings (TiAlN, TiCN, AM200®).</li> <li>Reduce feeds (<b>NOTICE:</b> Do not reduce feed below threshold of good chip formation).</li> </ul>
Poor chip control.								8		10	11		13					17	18	19	20		<ul style="list-style-type: none"> <li>Increase feed to recommended levels. Contact Allied Application Engineering team for technical recommendations.</li> <li>Increase coolant pressure and volume.</li> <li>Improve coolant condition by use of quality products and regular maintenance.</li> <li>See pages A30: 4 - 5 for special purpose geometries.</li> </ul>
Spot drilled holes with included angle less than that matching T-A® or cored holes.	1			4			7						13			16				19			<ul style="list-style-type: none"> <li>Spot hole with short tool of same or greater included angle as T-A® drill insert.</li> <li>Reduce feed (<b>NOTICE:</b> Do not reduce feed below threshold of good chip formation)</li> <li>If possible, drill from solid.</li> </ul>
Use of high wear resistant insert grades.				4						10													<ul style="list-style-type: none"> <li>Use tougher grade of T-A® (from carbide to cobalt to HSS). See wear versus toughness chart on page A30: 9.</li> <li>Increase rigidity of setup.</li> </ul>

## Deep Hole Drilling Guidelines

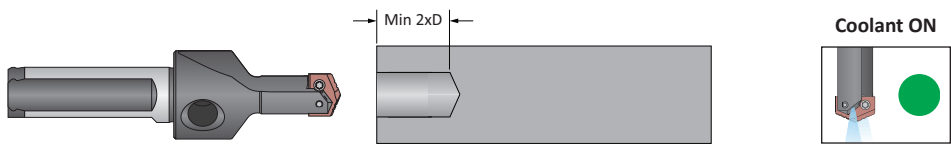
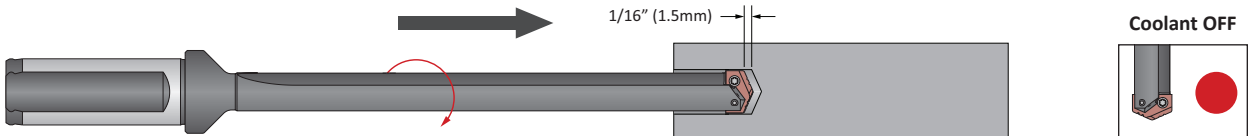
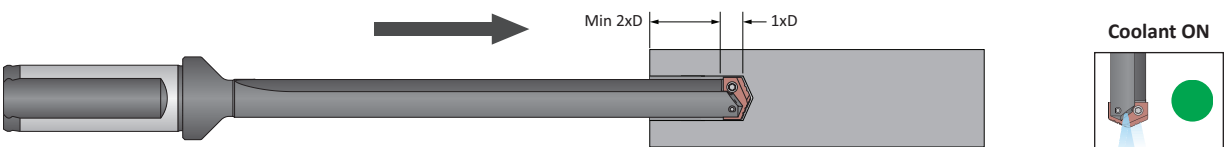
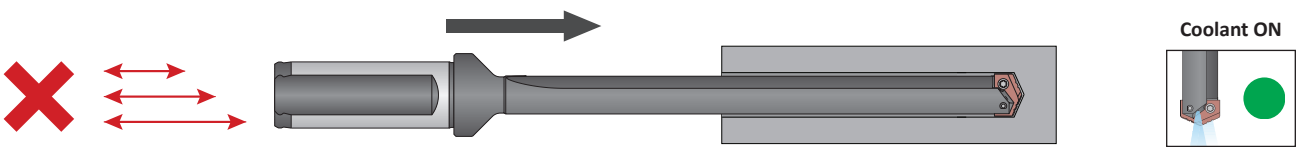
For Lengths Greater Than 9xD (including Extended, Long, XL, 3XL, and Special Length)

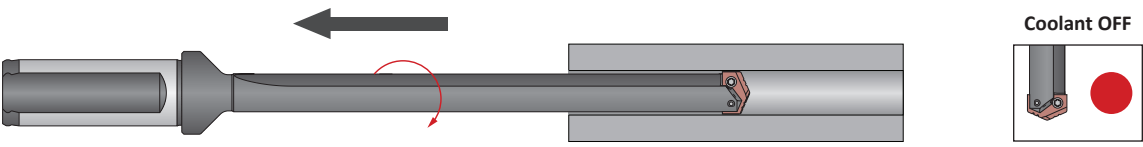
A DRILLING	<p><b>1. Pilot Hole</b> 100 % RPM 100% IPR (mm/rev)</p>	<p>Establish the pilot hole using the same diameter short drill to a depth of 2xD minimum. Utilize a pilot drill with the same or larger included point angle.</p>	
B BORING	<p><b>2. Feed-in</b> 50 RPM max 12 IPM (300 mm/min)</p>	<p>Feed the longer drill within 1/16" (1.5mm) short of the established pilot hole bottom at a <b>maximum of 50 RPM</b> and 12 IPM (300 mm/min) feed rate.</p>	
C REAMING	<p><b>3. Deep Hole Transition Drilling</b> 50 % RPM 75% IPR (mm/rev)</p>	<p>Drill additional 1xD past the bottom of the pilot hole at 50% reduction of recommended speed and 25% reduction of recommended feed. Minimum of 1 second dwell is required to meet full speed before feeding.</p>	
D BURNISHING	<p><b>4. Deep Hole Drilling - Blind</b> 100% RPM 100% IPR (mm/rev)</p>	<p>Drill to full depth at recommended speed and feed for longer drill according to Allied speed and feed charts. <b>No peck cycle recommended.</b></p>	
E THREADING	<p><b>5. Deep Hole Drilling - at Breakout</b> 50% RPM 75% IPR (mm/rev)</p>	<p><b>For through holes only:</b> Reduce speed by 50% and feed by 25% prior to breakout. Do not breakout more than 1/8" (3mm) past the full diameter of the drill.</p>	
X SPECIALS	<p><b>6. Drill Retract</b> 50 RPM max</p>	<p>Reduce speed to a <b>maximum of 50 RPM</b> before retracting from the hole.</p>	

**1. WARNING** Tool failure can cause serious injury. To prevent:

- When using holders without support bushing, use a short T-A® holder to establish an initial hole that is a minimum of 2 diameters deep.
- Do not rotate tool holder more than 50 RPM unless it is engaged with the workpiece or fixture.

Visit [www.alliedmachine.com/DeepHoleGuidelines](http://www.alliedmachine.com/DeepHoleGuidelines) for the most up-to-date information and procedures. Factory technical assistance is available for your specific applications through our Application Engineering Team.







SECTION

---

# A40

---

High Performance / Universal

# High Performance and Universal

## Replaceable Spade Drill Insert Drilling System

► Diameter Range: 0.9688" - 8.5000"



### Since the Beginning

The Universal spade drill is the original design that launched Allied Machine into the holemaking industry. After the T-A<sup>®</sup> was introduced, customers who already owned the Universal style holders wanted the same benefits offered by the T-A without having to invest in an entirely new system.

The High Performance (HP) insert was created to provide similar performance as the T-A. The HP insert (along with an adapter for larger sizes) fits into existing Universal style holders.

When the customers speak, we listen.

### Applicable Industries



Aerospace



Agriculture



Automotive



Energy



Firearms



General Machining



Oil & Gas

Your safety and the safety of others is very important. This catalog contains important safety messages. Always read and follow all safety precautions.



This triangle is a safety hazard symbol. It alerts you to potential safety hazards that can cause tool failure and serious injury.

When you see this symbol in the catalog, look for a related safety message that may be near this triangle or referred to in the nearby text.

There are safety signal words also used in the catalog. Safety messages follow these words.

#### **WARNING**

**WARNING** (shown above) means that failure to follow the precautions in this message could result in tool failure and serious injury.

**NOTICE** means that failure to follow the precautions in this message could result in damage to the tool or machine but not result in personal injury.

**NOTE** and **IMPORTANT** are also used. These are important that you read and follow but are not safety-related.

Visit [www.alliedmachine.com](http://www.alliedmachine.com) for the most up-to-date information and procedures.

# High Performance / Universal Drilling System Contents

## Reference Icons

The following icons will appear throughout the catalog to help you navigate between products.

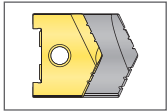

### High Performance / Universal Inserts

Refers to the range of inserts that connect with the corresponding holders

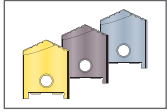

### Universal Insert Coating Options

Details and overview of the different coatings available for Universal spade drill inserts

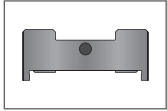

### Insert Adapter Information

Detailed information regarding the corresponding adapter item

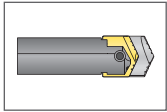

### High Performance / Universal Holders

Refers to the range of holders that connect with the corresponding inserts

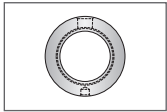

### Rotary Coolant Adapter (RCA) Information

Detailed instructions and information regarding the corresponding RCA part

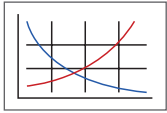

### Recommended Cutting Data

Speed and feed recommendations for optimum and safe drilling

Series	Diameter Range - Imperial (in)
A	0.9688 - 1.2500
B	1.2500 - 1.7500
C	1.5000 - 2.3750
D	2.0000 - 2.8750
E	2.5000 - 3.3750
F	3.0000 - 3.8750
G	3.5000 - 4.5000
H <sup>1</sup> - H <sup>2</sup>	4.0000 - 5.0000
H <sup>3</sup> - H <sup>9</sup>	5.1250 - 8.5000

## Introduction Information

System Overview . . . . .	2 - 3
Product Nomenclature . . . . .	4 - 5

## Drill Series

A Series . . . . .	6 - 9
B Series . . . . .	10 - 13
C Series . . . . .	14 - 17
D Series . . . . .	18 - 21
E Series . . . . .	22 - 25
F Series . . . . .	26 - 29
G Series . . . . .	30 - 33
H Series . . . . .	34 - 37

## Accessories

Adapters and Blade-Loc Screws . . . . .	38 - 39
Rotary Coolant Adapters (RCA) . . . . .	40
Top Mounting Plate . . . . .	41
Cylindrical Grinding Fixtures . . . . .	41

## Recommended Cutting Data

Regrind Charts . . . . .	42 - 43
High Performance Inserts . . . . .	44 - 45
Universal Inserts . . . . .	46 - 47
Deep Hole Drilling Guidelines . . . . .	48

**System Overview | Inserts**

A  
DRILLING  
B  
BORING  
C  
REAMING  
D  
URNISHING  
E  
HREADING  
X  
PECIALS

**High Performance Inserts**

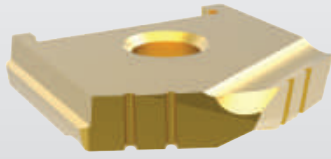

A - C Series

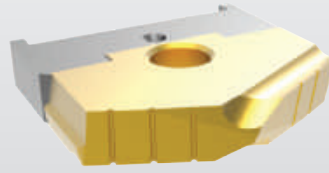

D - H Series  
(adapter required)

**High Performance Inserts**

- Increase production 100 - 500% compared to uncoated Universal spade drill inserts
- Fit into Universal style holders
- Available in TiN and TiAlN coatings
- Single-piece design (A - C series) eliminates the need for adapters, which maximizes tool performance in these smaller sizes

**Universal Inserts**

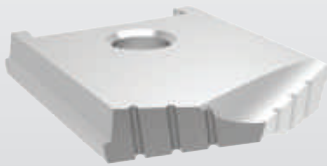

130° CPM-M4  
130° CPM-T15

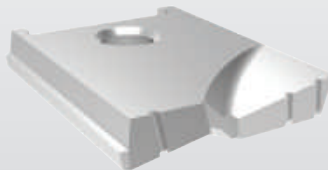

Flat Bottom

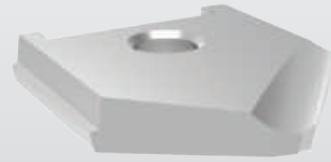

90° Spot and Chamfer

**Universal Inserts**

- Standard inserts stocked uncoated
- Also available in TiN, TiAlN, and TiCN coatings, which improve tool life when compared to uncoated inserts

TiN Coating	
Ordering Code: T	Example: 10224-0116 <b>T</b>

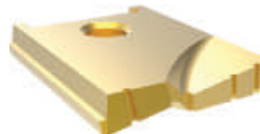
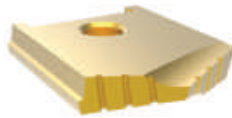

TiAlN Coating	
Ordering Code: A	Example: 10224-0116 <b>A</b>

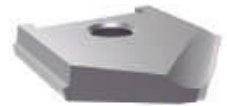
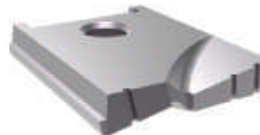
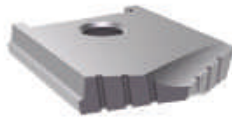

TiCN Coating	
Ordering Code: N	Example: 10224-0116 <b>N</b>

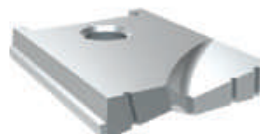



**Straight Shank Holders**

- Stub (#125)
- Short (#150)
- Short (#100)
- Standard (#200)
- Long (#250)



**Taper Shank Holders**

- Short (#300)
- Short (#300 TSC)
- Short (#400 SR)
- Standard (#500 SR)
- Long (#600 SR)
- XL (#700 SR)



**50 NMTB Shank Holders**

- Short (#300)
- Short (#400)
- Standard (#500 SR)



**Adapter\***

for High Performance D - H series inserts only



\*For detailed information and set-up for adapters and Blade-Loc screw assembly, see page A40: 38

## Product Nomenclature

### High Performance Spade Drill Inserts

<b>1</b>	<b>02</b>	<b>8</b>	<b>T</b>	-	<b>0406</b>
1	2	3	4		5

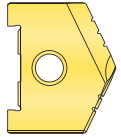

1. Spade Drill Insert	2. Material	3. Series	4. Coating	5. Diameter (by 1/32")
1 = Spade drill insert	02 = High speed steel	1 = A series 2 = B series 3 = C series 4 = D series 5 = E series 6 = F series 7 = G series 8 = H series	T = TiN A = TiAlN N = TiCN	0406 = Inch 4.3593 = Decimal

### Universal Spade Drill Inserts

<b>1</b>	<b>02</b>	<b>8</b>	<b>4</b>	-	<b>0406</b>	<b>T</b>
1	2	3	4		5	6

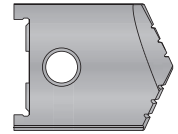

1. Spade Drill Insert	2. Insert Style	3. Series	4. Material
1 = Spade drill insert	02 = 130° Spade 04 = Flat Bottom 12 = 90° Spot and Chamfer	1 = A series 2 = B series 3 = C series 4 = D series 5 = E series 6 = F series 7 = G series 8 = H1 - H2 series 9 = H3 - H9 series J = J series	2 = M-2 (J series only) 4 = High speed steel (SPM-M4 HSS) 5 = High speed steel (CPM-T15 HSS)*  *discontinued

5. Diameter (by 1/32")	6. Coating
0406 = Inch 4.3593 = Decimal	Blank = Uncoated T = TiN A = TiAlN N = TiCN

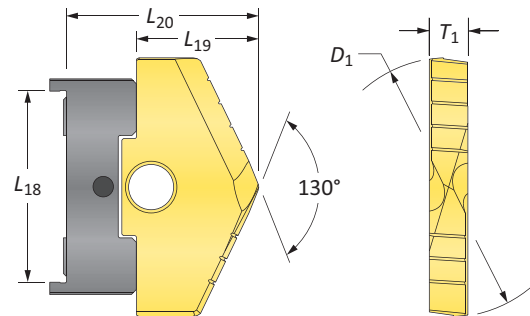

#### Reference Key

Symbol	Attribute
$D_1$	Insert diameter
$L_{18}$	Holder locating area
$L_{19}$	Reference length
$L_{20}$	High Performance length (with adapter)
$T_1$	Thickness

## Product Nomenclature

### High Performance / Universal Spade Drill Insert Holders

<b>2</b>	<b>22</b>	<b>8</b>	<b>1</b>	-	<b>0006</b>
1	2	3	4		5



1. Holder	2. Classification	3. Series																					
2 = Drill holder	<table border="0"> <tr> <td><b>Straight Shank</b></td> <td><b>Taper Shank</b></td> <td><b>50 NMTB Shank</b></td> </tr> <tr> <td><b>02</b> = Stub #125 (NC)</td> <td><b>14</b> = Short #300 (NC)</td> <td><b>24</b> = Short #300 (NC)</td> </tr> <tr> <td><b>04</b> = Short #150 (NC)</td> <td><b>15</b> = Short #300 (TSC)</td> <td><b>26</b> = Short #400 (C)</td> </tr> <tr> <td><b>06</b> = Short #100 (C)</td> <td><b>16</b> = Short #400 SR (RCA)</td> <td><b>28</b> = Standard #500 (C)</td> </tr> <tr> <td><b>08</b> = Standard #200 (C)</td> <td><b>18</b> = Standard #500 SR (RCA)</td> <td></td> </tr> <tr> <td><b>10</b> = Long #250 (C)</td> <td><b>20</b> = Long #600 SR (RCA)</td> <td></td> </tr> <tr> <td></td> <td><b>22</b> = XL #700 SR SR (RCA)</td> <td></td> </tr> </table> <p><i>C = Coolant   NC = No Coolant   TSC = Through Shank Coolant   RCA = Rotary Coolant Adapter</i></p>	<b>Straight Shank</b>	<b>Taper Shank</b>	<b>50 NMTB Shank</b>	<b>02</b> = Stub #125 (NC)	<b>14</b> = Short #300 (NC)	<b>24</b> = Short #300 (NC)	<b>04</b> = Short #150 (NC)	<b>15</b> = Short #300 (TSC)	<b>26</b> = Short #400 (C)	<b>06</b> = Short #100 (C)	<b>16</b> = Short #400 SR (RCA)	<b>28</b> = Standard #500 (C)	<b>08</b> = Standard #200 (C)	<b>18</b> = Standard #500 SR (RCA)		<b>10</b> = Long #250 (C)	<b>20</b> = Long #600 SR (RCA)			<b>22</b> = XL #700 SR SR (RCA)		<p><b>1</b> = A series  <b>2</b> = B series  <b>3</b> = C series  <b>4</b> = D series  <b>5</b> = E series  <b>6</b> = F series  <b>7</b> = G series  <b>8</b> = H series</p>
<b>Straight Shank</b>	<b>Taper Shank</b>	<b>50 NMTB Shank</b>																					
<b>02</b> = Stub #125 (NC)	<b>14</b> = Short #300 (NC)	<b>24</b> = Short #300 (NC)																					
<b>04</b> = Short #150 (NC)	<b>15</b> = Short #300 (TSC)	<b>26</b> = Short #400 (C)																					
<b>06</b> = Short #100 (C)	<b>16</b> = Short #400 SR (RCA)	<b>28</b> = Standard #500 (C)																					
<b>08</b> = Standard #200 (C)	<b>18</b> = Standard #500 SR (RCA)																						
<b>10</b> = Long #250 (C)	<b>20</b> = Long #600 SR (RCA)																						
	<b>22</b> = XL #700 SR SR (RCA)																						

4. Holder Style	5. Shank Size and Configuration																					
1 = Universal	<table border="0"> <tr> <td><b>Straight Shank</b></td> <td><b>Taper Shank</b></td> <td><b>NMTB Shank</b></td> </tr> <tr> <td><b>0750</b> = 0.750" Straight Shank</td> <td><b>0002</b> = #2 Morse Taper Shank</td> <td><b>0050</b> = 50 NMTB Shank</td> </tr> <tr> <td><b>1000</b> = 1.000" Straight Shank</td> <td><b>0003</b> = #3 Morse Taper Shank</td> <td></td> </tr> <tr> <td><b>1250</b> = 1.250" Straight Shank</td> <td><b>0004</b> = #4 Morse Taper Shank</td> <td></td> </tr> <tr> <td><b>1500</b> = 1.500" Straight Shank</td> <td><b>0005</b> = #5 Morse Taper Shank</td> <td></td> </tr> <tr> <td><b>2000</b> = 2.000" Straight Shank</td> <td><b>0006</b> = #6 Morse Taper Shank</td> <td></td> </tr> <tr> <td><b>3000</b> = 3.000" Straight Shank</td> <td></td> <td></td> </tr> </table>	<b>Straight Shank</b>	<b>Taper Shank</b>	<b>NMTB Shank</b>	<b>0750</b> = 0.750" Straight Shank	<b>0002</b> = #2 Morse Taper Shank	<b>0050</b> = 50 NMTB Shank	<b>1000</b> = 1.000" Straight Shank	<b>0003</b> = #3 Morse Taper Shank		<b>1250</b> = 1.250" Straight Shank	<b>0004</b> = #4 Morse Taper Shank		<b>1500</b> = 1.500" Straight Shank	<b>0005</b> = #5 Morse Taper Shank		<b>2000</b> = 2.000" Straight Shank	<b>0006</b> = #6 Morse Taper Shank		<b>3000</b> = 3.000" Straight Shank		
<b>Straight Shank</b>	<b>Taper Shank</b>	<b>NMTB Shank</b>																				
<b>0750</b> = 0.750" Straight Shank	<b>0002</b> = #2 Morse Taper Shank	<b>0050</b> = 50 NMTB Shank																				
<b>1000</b> = 1.000" Straight Shank	<b>0003</b> = #3 Morse Taper Shank																					
<b>1250</b> = 1.250" Straight Shank	<b>0004</b> = #4 Morse Taper Shank																					
<b>1500</b> = 1.500" Straight Shank	<b>0005</b> = #5 Morse Taper Shank																					
<b>2000</b> = 2.000" Straight Shank	<b>0006</b> = #6 Morse Taper Shank																					
<b>3000</b> = 3.000" Straight Shank																						

#### Reference Key

Symbol	Attribute
$D_1$	Insert diameter
$D_2$	Shank diameter
$L_1$	Overall length
$L_{3HP}$	Reference length (High Performance)
$L_{3U}$	Reference length (Universal)
$L_4$	Flute length
$L_7$	Shank length
$P_1$	Pipe tap

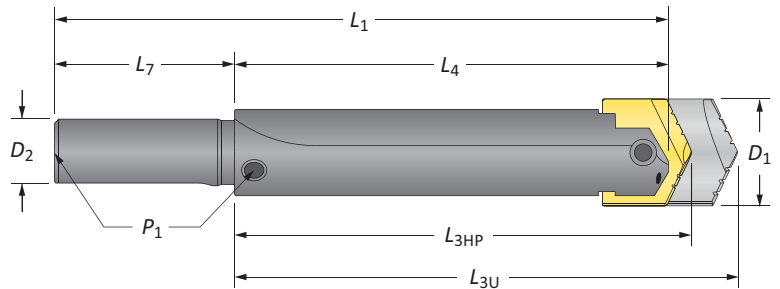



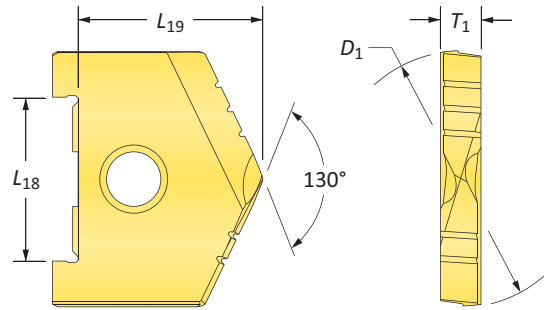
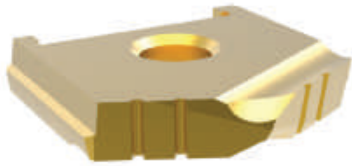

## High Performance Spade Drill Inserts

A Series | Diameter Range: 0.9688" - 1.3750"



Series	$D_1$ inch		Inserts					
	Fraction	Decimal	$L_{18}$	$L_{19}$	$T_1$	TiN Part No.	TiAlN Part No.	TiCN Part No.
A	31/32	0.9688	3/4	7/8	3/16	1021T-0031	1021A-0031	1021N-0031
	1	1.0000	3/4	7/8	3/16	1021T-0100	1021A-0100	1021N-0100
	1-1/32	1.0313	3/4	7/8	3/16	1021T-0101	1021A-0101	1021N-0101
	1-1/16	1.0625	3/4	7/8	3/16	1021T-0102	1021A-0102	1021N-0102
	1-3/32	1.0938	3/4	7/8	3/16	1021T-0103	1021A-0103	1021N-0103
	1-1/8	1.1250	3/4	7/8	3/16	1021T-0104	1021A-0104	1021N-0104
	1-5/32	1.1563	3/4	7/8	3/16	1021T-0105	1021A-0105	1021N-0105
	1-3/16	1.1875	3/4	7/8	3/16	1021T-0106	1021A-0106	1021N-0106
	1-7/32	1.2188	3/4	7/8	3/16	1021T-0107	1021A-0107	1021N-0107
A Oversize	1-1/4	1.2500	3/4	7/8	3/16	1021T-0108	1021A-0108	1021N-0108
	1-9/32	1.2813	3/4	7/8	3/16	1021T-0109	1021A-0109	1021N-0109
	1-5/16	1.3125	3/4	7/8	3/16	1021T-0110	1021A-0110	1021N-0110
	1-11/32	1.3438	3/4	7/8	3/16	1021T-0111	1021A-0111	1021N-0111
	1-3/8	1.3750	3/4	7/8	3/16	1021T-0112	1021A-0112	1021N-0112

Inserts sold in multiples of 1

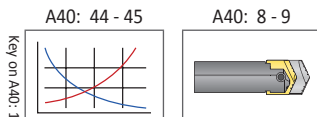

Sizes not shown are available upon request.  
When ordering, please follow the example below:

<b>Inch:</b>	7-63/64", 130° CPM-M4 (H8 series) = use Part No. <b>10294-7.9843</b>
<b>Decimal:</b>	6.391", 130° CPM-M4 (H5 series) = use Part No. <b>10294-6.3910</b>





## Universal Spade Drill Inserts

A Series | Diameter Range: 0.9688" - 1.3750"

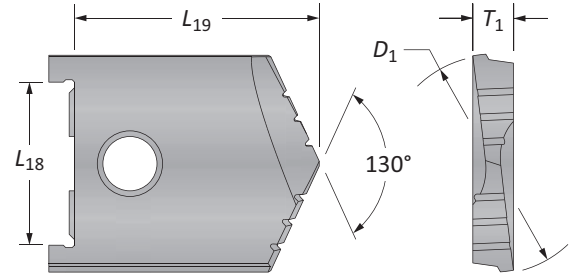
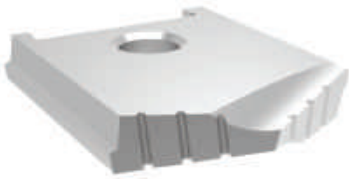

Series	D <sub>1</sub> inch		Inserts						
	Fraction	Decimal	L <sub>18</sub>	L <sub>19</sub>	T <sub>1</sub>	130° CPM-M4	130° CPM-T15*	Flat Bottom	90° Spot & Chamfer
A	31/32	0.9688	3/4	1-5/32	3/16	10214-0031	-	-	POR
	1	1.0000	3/4	1-5/32	3/16	10214-0100	-	10414-0100	POR
	1-1/32	1.0313	3/4	1-5/32	3/16	10214-0101	-	-	POR
	1-1/16	1.0625	3/4	1-5/32	3/16	10214-0102	10215-0102	10414-0102	POR
	1-3/32	1.0938	3/4	1-5/32	3/16	10214-0103	-	-	POR
	1-1/8	1.1250	3/4	1-5/32	3/16	10214-0104	10215-0104	10414-0104	POR
	1-5/32	1.1563	3/4	1-5/32	3/16	10214-0105	-	-	POR
	1-3/16	1.1875	3/4	1-5/32	3/16	10214-0106	10215-0106	10414-0106	POR
	1-7/32	1.2188	3/4	1-5/32	3/16	10214-0107	-	-	POR
1-1/4	1.2500	3/4	1-5/32	3/16	10214-0108	-	10414-0108	11214-0108	
A Oversize	1-9/32	1.2813	3/4	1-5/32	3/16	10214-0109	-	-	-
	1-5/16	1.3125	3/4	1-5/32	3/16	10214-0110	-	-	-
	1-11/32	1.3438	3/4	1-5/32	3/16	10214-0111	-	-	-
	1-3/8	1.3750	3/4	1-5/32	3/16	10214-0112	-	-	-

\*Discontinued

NOTE: POR = Priced on request

Flat Bottom

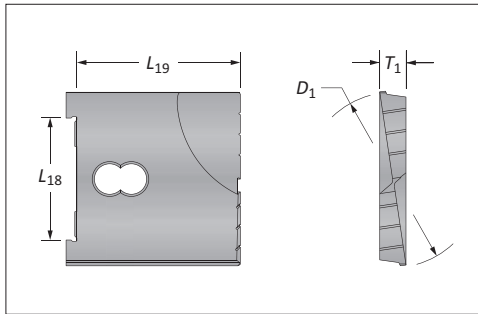

90° Spot & Chamfer

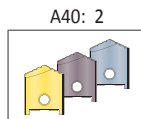
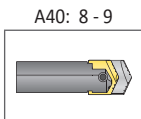
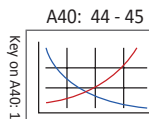
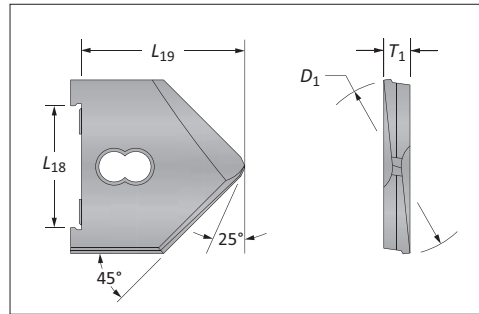

Sizes not shown are available upon request.  
When ordering, please follow the example below:

Inch:	1-17/64", 130° CPM-M4 (B series) = use Part No. 10224-1.2656
Decimal:	1.5110", 130° Flat Bottom (C series) = use Part No. 10434-1.5110



## High Performance / Universal Spade Drill Insert Holders

## A Series

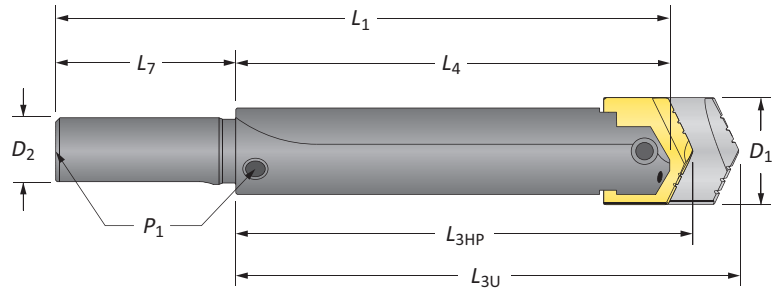

## Straight Shank

Length	$D_1$	Holder				Shank				Style	Part No.
		$L_{3HP}$	$L_{3U}$	$L_4$	$L_1$	$D_2$	$L_7$	$P_1$			
Short	31/32 - 1-3/8	3-1/4	3-17/32	3	6-1/2	3/4	3-1/2	-	#150	20411-0750	
Short	31/32 - 1-3/8	3-1/4	3-17/32	3	6-1/2	1	3-1/2	-	#150	20411-1000	
Short	31/32 - 1-3/8	3-1/4	3-17/32	3	6-1/2	1	3-1/2	1/8	#100	20611-1000	
Short	31/32 - 1-3/8	3-1/4	3-17/32	3	6-1/2	1-1/2	3-1/2	1/8	#100	20611-1500	
Standard	31/32 - 1-3/8	8	8-9/32	7-3/4	11-1/4	3/4	3-1/2	1/8	#200	20811-0750	
Standard	31/32 - 1-3/8	8	8-9/32	7-3/4	11-1/4	1	3-1/2	1/8	#200	20811-1000	
Standard	31/32 - 1-3/8	8	8-9/32	7-3/4	11-1/4	1-1/2	3-1/2	1/8	#200	20811-1500	
Long	31/32 - 1-3/8	15-1/4	15-17/32	15	18-1/2	1	3-1/2	1/8	#250	21011-1000	

## Connection Accessories



Clamping Screw

#10-24 x 5/8"



Blade-Loc Screw

-

A40: 6 - 7



**i** = Imperial (in)  
**m** = Metric (mm)

**WARNING** Refer to Speed and Feed charts for recommended adjustments to speeds and feeds. Refer to page A40: 48 for deep hole drilling guidelines in this section of the catalog. Visit [www.alliedmachine.com/DeepHoleGuidelines](http://www.alliedmachine.com/DeepHoleGuidelines) for the most up-to-date information and procedures. Factory technical assistance is available for your specific applications through our Application Engineering Team.



## High Performance / Universal Spade Drill Insert Holders

### A Series

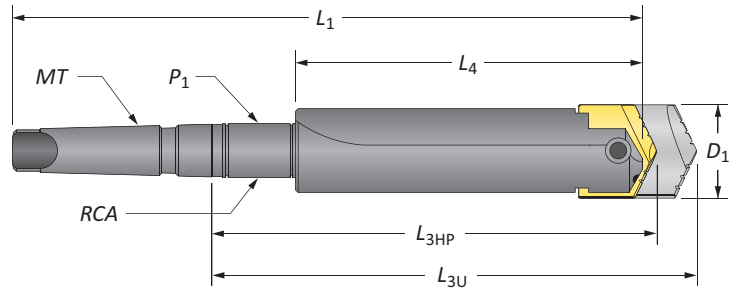

### Taper Shank

Length	D <sub>1</sub>	Holder				Shank					Part No.
		L <sub>3HP</sub>	L <sub>3U</sub>	L <sub>4</sub>	L <sub>1</sub>	MT	P <sub>1</sub>	RCA	Style		
Short	31/32 - 1-3/8	3-7/16	3-23/32	3	6-7/8	#3	-	-	#300	21411-0003	
Short	31/32 - 1-3/8	3-1/2	3-13/16	3	7-7/8	#4	-	-	#300	21411-0004	
Short	31/32 - 1-3/8	3-7/16	3-23/32	3	6-7/8	#3	-	-	#300 TSC	21511-0003*	
Short	31/32 - 1-3/8	5-3/16	5-15/32	3	9-9/16	#4	1/4	2T-4SR	#400 SR	21611-0004	
Standard	31/32 - 1-3/8	9-15/16	10-7/32	7-3/4	14-5/16	#4	1/4	2T-4SR	#500 SR	21811-0004	
Long	31/32 - 1-3/8	17-3/16	17-15/32	15	21-9/16	#4	1/4	2T-4SR	#600 SR	22011-0004	
XL	31/32 - 1-3/8	23-3/16	23-15/32	21	27-9/16	#4	1/4	2T-4SR	#700 SR	22211-0004	

\*Through shank coolant, coolant inlet diameter = 1/4"

### Rotary Coolant Adapter (RCA) and Accessories

ID	OD	L <sub>1</sub>	Driving Rod Thread	P <sub>1</sub>	Part No.*	RCA O-Rings	
						Kit Part No.**	Replacements
1-1/4	2-1/2	1-3/8	3/8 - NC	1/4	2T-4SR	2T1-4SR	2T1-4OR-10

\*RCA comes complete with (1) RCA, (2) O-rings, (2) snap rings, and (2) thrust washers

\*\*RCA Repair Kit includes (2) O-rings, (2) snap rings, and (2) thrust washers

Refer to page A40: 40 for proper RCA assembly and safety information

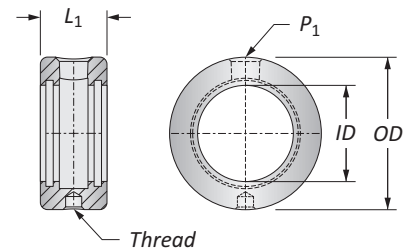

### Connection Accessories

Clamping Screw	Blade-Loc Screw
#10-24 x 5/8"	-

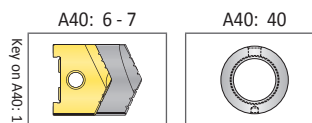

ⓘ = Imperial (in)  
 ⓘ = Metric (mm)  
 O-rings sold in packs of 10

**WARNING** Refer to Speed and Feed charts for recommended adjustments to speeds and feeds. Refer to page A40: 48 for deep hole drilling guidelines in this section of the catalog. Visit [www.alliedmachine.com/DeepHoleGuidelines](http://www.alliedmachine.com/DeepHoleGuidelines) for the most up-to-date information and procedures. Factory technical assistance is available for your specific applications through our Application Engineering Team.



## High Performance Spade Drill Inserts

B Series | Diameter Range: 1.2500" - 1.7500"

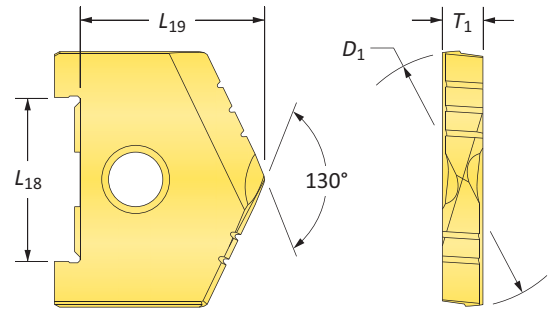
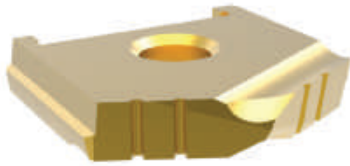

Series	D <sub>1</sub> inch		Insert			TiN Part No.	TiAlN Part No.	TiCN Part No.
	Fraction	Decimal	L <sub>18</sub>	L <sub>19</sub>	T <sub>1</sub>			
B	1-1/4	1.2500	1-1/16	1-3/32	9/32	1022T-0108	1022A-0108	1022N-0108
	1-9/32	1.2813	1-1/16	1-3/32	9/32	1022T-0109	1022A-0109	1022N-0109
	1-5/16	1.3125	1-1/16	1-3/32	9/32	1022T-0110	1022A-0110	1022N-0110
	1-11/32	1.3438	1-1/16	1-3/32	9/32	1022T-0111	1022A-0111	1022N-0111
	1-3/8	1.3750	1-1/16	1-3/32	9/32	1022T-0112	1022A-0112	1022N-0112
	1-13/32	1.4063	1-1/16	1-3/32	9/32	1022T-0113	1022A-0113	1022N-0113
	1-7/16	1.4375	1-1/16	1-3/32	9/32	1022T-0114	1022A-0114	1022N-0114
	1-15/32	1.4688	1-1/16	1-3/32	9/32	1022T-0115	1022A-0115	1022N-0115
B Oversize	1-1/2	1.5000	1-1/16	1-3/32	9/32	1022T-0116	1022A-0116	1022N-0116
	1-17/32	1.5313	1-1/16	1-3/32	9/32	1022T-0117	1022A-0117	1022N-0117
	1-9/16	1.5625	1-1/16	1-3/32	9/32	1022T-0118	1022A-0118	1022N-0118
	1-19/32	1.5938	1-1/16	1-3/32	9/32	1022T-0119	1022A-0119	1022N-0119
	1-5/8	1.6250	1-1/16	1-3/32	9/32	1022T-0120	1022A-0120	1022N-0120
	1-21/32	1.6563	1-1/16	1-3/32	9/32	1022T-0121	1022A-0121	1022N-0121
	1-11/16	1.6875	1-1/16	1-3/32	9/32	1022T-0122	1022A-0122	1022N-0122
	1-23/32	1.7188	1-1/16	1-3/32	9/32	1022T-0123	1022A-0123	1022N-0123
	1-3/4	1.7500	1-1/16	1-3/32	9/32	1022T-0124	1022A-0124	1022N-0124

Inserts sold in multiples of 1

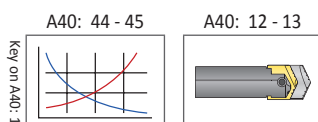

A40: 10

Sizes not shown are available upon request.

When ordering, please follow the example below:

<b>Inch:</b>	7-63/64", 130° CPM-M4 (H8 series) = use Part No. <b>10294-7.9843</b>
<b>Decimal:</b>	6.391", 130° CPM-M4 (H5 series) = use Part No. <b>10294-6.3910</b>



## Universal Spade Drill Inserts

B Series | Diameter Range: 1.2500" - 1.7500"

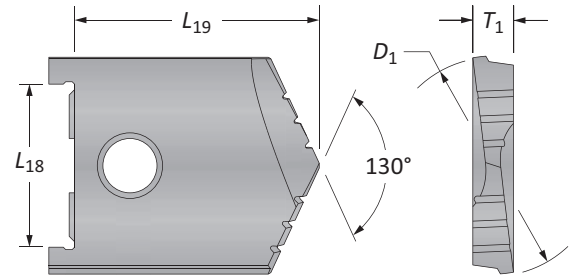

Series	D <sub>1</sub> inch		Insert						
	Fraction	Decimal	L <sub>18</sub>	L <sub>19</sub>	T <sub>1</sub>	130° CPM-M4	130° CPM-T15*	Flat Bottom	90° Spot & Chamfer
B	1-1/4	1.2500	1-1/16	1-13/32	9/32	10224-0108	-	10424-0108	POR
	1-9/32	1.2813	1-1/16	1-13/32	9/32	10224-0109	-	-	POR
	1-5/16	1.3125	1-1/16	1-13/32	9/32	10224-0110	10225-0110	10424-0110	POR
	1-11/32	1.3438	1-1/16	1-13/32	9/32	10224-0111	-	-	POR
	1-3/8	1.3750	1-1/16	1-13/32	9/32	10224-0112	-	10424-0112	POR
	1-13/32	1.4063	1-1/16	1-13/32	9/32	10224-0113	-	-	POR
	1-7/16	1.4375	1-1/16	1-13/32	9/32	10224-0114	-	10424-0114	POR
	1-15/32	1.4688	1-1/16	1-13/32	9/32	10224-0115	-	-	POR
	1-1/2	1.5000	1-1/16	1-13/32	9/32	10224-0116	-	10424-0116	11224-0116
B Oversize	1-17/32	1.5313	1-1/16	1-13/32	9/32	10224-0117	-	-	-
	1-9/16	1.5625	1-1/16	1-13/32	9/32	10224-0118	-	-	-
	1-19/32	1.5938	1-1/16	1-13/32	9/32	10224-0119	-	-	-
	1-5/8	1.6250	1-1/16	1-13/32	9/32	10224-0120	-	-	-
	1-21/32	1.6563	1-1/16	1-13/32	9/32	10224-0121	-	-	-
	1-11/16	1.6875	1-1/16	1-13/32	9/32	10224-0122	-	-	-
	1-23/32	1.7188	1-1/16	1-13/32	9/32	10224-0123	-	-	-
	1-3/4	1.7500	1-1/16	1-13/32	9/32	10224-0124	-	-	-

\*Discontinued

NOTE: POR = Priced on request

Flat Bottom

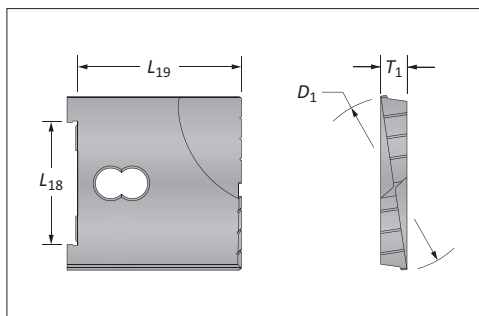

90° Spot & Chamfer

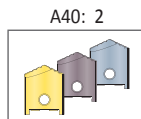
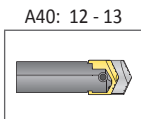
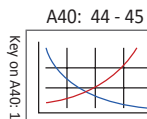
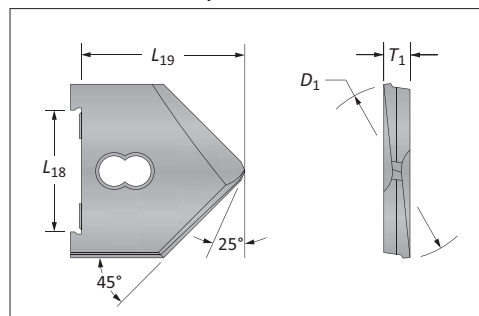

Sizes not shown are available upon request.  
When ordering, please follow the example below:

Inch:	1-17/64", 130° CPM-M4 (B series) = use Part No. <b>10224-1.2656</b>
Decimal:	1.5110", 130° Flat Bottom (C series) = use Part No. <b>10434-1.5110</b>

## High Performance / Universal Spade Drill Insert Holders

### B Series

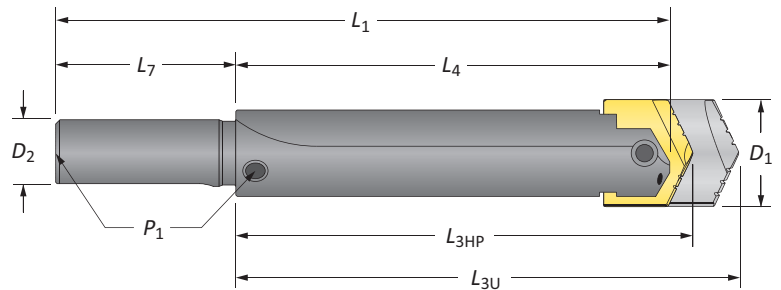

#### Straight Shank

Length	D <sub>1</sub> Range	Holder				Shank				Style	Part No.
		L <sub>3HP</sub>	L <sub>3U</sub>	L <sub>4</sub>	L <sub>1</sub>	D <sub>2</sub>	L <sub>7</sub>	P <sub>1</sub>			
Short	1-1/4 - 1-3/4	3-25/32	4-3/32	3-1/2	7	1	3-1/2	-	#150	<b>20421-1000</b>	
Short	1-1/4 - 1-3/4	3-25/32	4-3/32	3-1/2	7	1	3-1/2	1/4	#100	<b>20621-1000</b>	
Short	1-1/4 - 1-3/4	3-25/32	4-3/32	3-1/2	7	1-1/4	3-1/2	1/4	#100	<b>20621-1250</b>	
<b>i</b> Short	1-1/4 - 1-3/4	3-25/32	4-3/32	3-1/2	7	1-1/2	3-1/2	1/4	#100	<b>20621-1500</b>	
Standard	1-1/4 - 1-3/4	8-13/32	8-23/32	8-1/8	11-5/8	1	3-1/2	1/4	#200	<b>20821-1000</b>	
Standard	1-1/4 - 1-3/4	8-13/32	8-23/32	8-1/8	11-5/8	1-1/4	3-1/2	1/4	#200	<b>20821-1250</b>	
Standard	1-1/4 - 1-3/4	8-13/32	8-23/32	8-1/8	11-5/8	1-1/2	3-1/2	1/4	#200	<b>20821-1500</b>	
Long	1-1/4 - 1-3/4	15-9/32	15-19/32	15	18-1/2	1-1/4	3-1/2	1/4	#250	<b>21021-1250</b>	

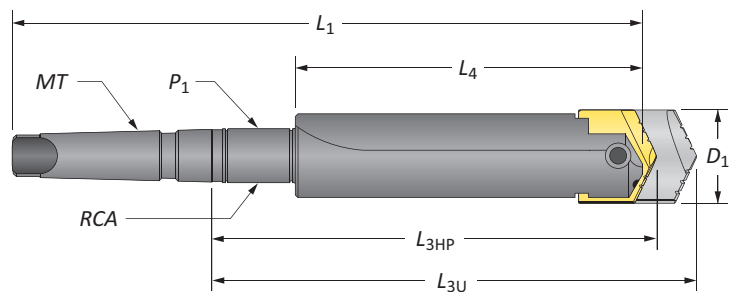

#### Taper Shank

Length	D <sub>1</sub> Range	Holder				Shank				Style	Part No.
		L <sub>3HP</sub>	L <sub>3U</sub>	L <sub>4</sub>	L <sub>1</sub>	MT	P <sub>1</sub>	RCA			
Short	1-1/4 - 1-3/4	3-31/32	4-9/32	3-1/2	7-3/8	#3	-	-	#300	<b>21421-0003</b>	
Short	1-1/4 - 1-3/4	4-1/32	4-11/32	3-1/2	8-3/8	#4	-	-	#300	<b>21421-0004</b>	
Short	1-1/4 - 1-3/4	4-1/32	4-11/32	3-1/2	8-3/8	#4	-	-	#300 TSC	<b>21521-0004*</b>	
<b>i</b> Short	1-1/4 - 1-3/4	5-23/32	6-1/32	3-1/2	10-1/16	#4	1/4	2T-4SR	#400 SR	<b>21621-0004</b>	
Standard	1-1/4 - 1-3/4	10-11/32	10-21/32	8-1/8	14-11/16	#4	1/4	2T-4SR	#500 SR	<b>21821-0004</b>	
Long	1-1/4 - 1-3/4	17-7/32	17-17/32	15	21-9/16	#4	1/4	2T-4SR	#600 SR	<b>22021-0004</b>	
XL	1-1/4 - 1-3/4	24-7/32	24-17/32	22	28-9/16	#4	1/4	2T-4SR	#700 SR	<b>22221-0004</b>	

\*Through shank coolant, coolant inlet diameter = 5/16"

#### Connection Accessories

<p><b>Clamping Screw</b> 1/4"-20 x 7/8</p>	<p><b>Blade-Loc Screw</b> -</p>
--	-------------------------------------

A40: 10 - 11



A40: 40

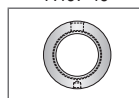

**i** = Imperial (in)  
**m** = Metric (mm)

**WARNING** Refer to Speed and Feed charts for recommended adjustments to speeds and feeds. Refer to page A40: 48 for deep hole drilling guidelines in this section of the catalog. Visit [www.alliedmachine.com/DeepHoleGuidelines](http://www.alliedmachine.com/DeepHoleGuidelines) for the most up-to-date information and procedures. Factory technical assistance is available for your specific applications through our Application Engineering Team.



## High Performance / Universal Spade Drill Insert Holders

B Series

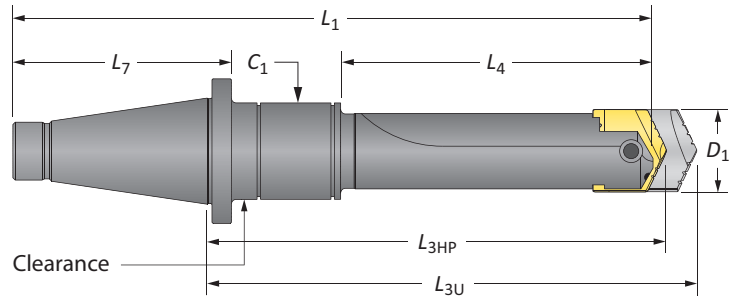

50 NMTB Shank\*

Length	D <sub>1</sub> Range	Holder				Shank					Part No.
		L <sub>3HP</sub>	L <sub>3U</sub>	L <sub>4</sub>	L <sub>1</sub>	MT	L <sub>7</sub>	C <sub>1</sub>	RCA	Style	
Short	1-1/4 - 1-3/4	5-13/32	5-23/32	4	10-1/8	50	5-5/8	–	–	#300	<b>22421-0050</b>
Short	1-1/4 - 1-3/4	7-3/32	7-13/32	4	11-13/16	50	5-5/8	3/8	2T-5SR	#400	<b>22621-0050</b>
Short	1-1/4 - 1-3/4	11-19/32	11-29/32	8-1/2	16-5/16	50	5-5/8	3/8	2T-5SR	#500	<b>22821-0050</b>

\*All NMTB shank holders are discontinued items. Items listed are available (subject to prior sale) at list prices until stock is depleted. Once stock is depleted, items are available as quoted specials only.

### Rotary Coolant Adapter (RCA) and Accessories

ID	OD	L <sub>1</sub>	Driving Rod Thread	P <sub>1</sub>	Part No.*	RCA O-Rings	
						Kit Part No.**	Replacements
1-1/4	2-1/2	1-3/8	3/8 - NC	1/4	<b>2T-4SR</b>	2T1-4SR	2T1-4OR-10
1-3/4	3	1-3/8	3/8 - NC	1/4	<b>2T-5SR</b>	2T1-5SR	2T1-5OR-10

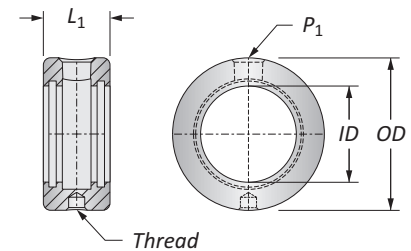

\*RCA comes complete with (1) RCA, (2) O-rings, (2) snap rings, and (2) thrust washers

\*\*RCA Repair Kit includes (2) O-rings, (2) snap rings, and (2) thrust washers

▲ Refer to page A40: 40 for proper RCA assembly and safety information

### Connection Accessories

Clamping Screw	Blade-Loc Screw
1/4"-20 x 7/8	–

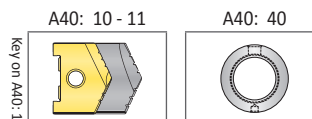

ⓘ = Imperial (in)  
 ⓘ = Metric (mm)  
 O-rings sold in packs of 10

**WARNING** RCA rotation during drilling can cause hose and/or hose fitting failure, machinery damage, and/or serious injury. To prevent, use RCA and positive stop studs when drilling. Factory technical assistance is also available for your specific applications.



## High Performance Spade Drill Inserts

C Series | Diameter Range: 1.5000" - 2.3750"

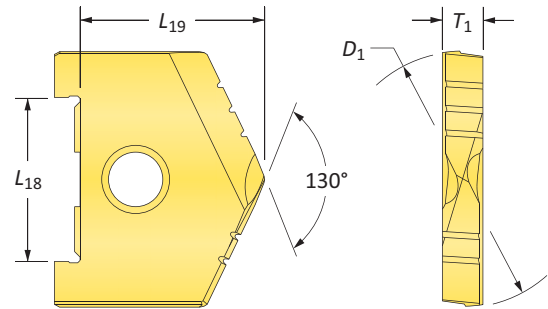

Series	D <sub>1</sub> inch		Insert			TiN Part No.	TiAlN Part No.	TiCN Part No.
	Fraction	Decimal	L <sub>18</sub>	L <sub>19</sub>	T <sub>1</sub>			
C	1-1/2	1.5000	1-1/4	1-19/64	5/16	1023T-0116	1023A-0116	1023N-0116
	1-17/32	1.5313	1-1/4	1-19/64	5/16	1023T-0117	1023A-0117	1023N-0117
	1-9/16	1.5625	1-1/4	1-19/64	5/16	1023T-0118	1023A-0118	1023N-0118
	1-19/32	1.5938	1-1/4	1-19/64	5/16	1023T-0119	1023A-0119	1023N-0119
	1-5/8	1.6250	1-1/4	1-19/64	5/16	1023T-0120	1023A-0120	1023N-0120
	1-21/32	1.6563	1-1/4	1-19/64	5/16	1023T-0121	1023A-0121	1023N-0121
	1-11/16	1.6875	1-1/4	1-19/64	5/16	1023T-0122	1023A-0122	1023N-0122
	1-23/32	1.7188	1-1/4	1-19/64	5/16	1023T-0123	1023A-0123	1023N-0123
	1-3/4	1.7500	1-1/4	1-19/64	5/16	1023T-0124	1023A-0124	1023N-0124
	1-25/32	1.7813	1-1/4	1-19/64	5/16	1023T-0125	1023A-0125	1023N-0125
	1-13/16	1.8125	1-1/4	1-19/64	5/16	1023T-0126	1023A-0126	1023N-0126
	1-27/32	1.8438	1-1/4	1-19/64	5/16	1023T-0127	1023A-0127	1023N-0127
	1-7/8	1.8750	1-1/4	1-19/64	5/16	1023T-0128	1023A-0128	1023N-0128
	1-29/32	1.9063	1-1/4	1-19/64	5/16	1023T-0129	1023A-0129	1023N-0129
	1-15/16	1.9375	1-1/4	1-19/64	5/16	1023T-0130	1023A-0130	1023N-0130
	1-31/32	1.9688	1-1/4	1-19/64	5/16	1023T-0131	1023A-0131	1023N-0131
2	2.0000	1-1/4	1-19/64	5/16	1023T-0200	1023A-0200	1023N-0200	
C Oversize	2-1/32	2.0313	1-1/4	1-19/64	5/16	1023T-0201	1023A-0201	1023N-0201
	2-1/16	2.0625	1-1/4	1-19/64	5/16	1023T-0202	1023A-0202	1023N-0202
	2-3/32	2.0938	1-1/4	1-19/64	5/16	1023T-0203	1023A-0203	1023N-0203
	2-1/8	2.1250	1-1/4	1-19/64	5/16	1023T-0204	1023A-0204	1023N-0204
	2-5/32	2.1563	1-1/4	1-19/64	5/16	1023T-0205	1023A-0205	1023N-0205
	2-3/16	2.1875	1-1/4	1-19/64	5/16	1023T-0206	1023A-0206	1023N-0206
	2-7/32	2.2188	1-1/4	1-19/64	5/16	1023T-0207	1023A-0207	1023N-0207
	2-1/4	2.2500	1-1/4	1-19/64	5/16	1023T-0208	1023A-0208	1023N-0208
	2-9/32	2.2813	1-1/4	1-19/64	5/16	1023T-0209	1023A-0209	1023N-0209
	2-5/16	2.3125	1-1/4	1-19/64	5/16	1023T-0210	1023A-0210	1023N-0210
	2-11/32	2.3438	1-1/4	1-19/64	5/16	1023T-0211	1023A-0211	1023N-0211
	2-3/8	2.3750	1-1/4	1-19/64	5/16	1023T-0212	1023A-0212	1023N-0212

Inserts sold in multiples of 1

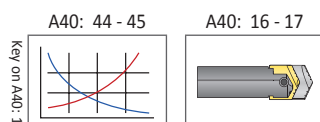

Sizes not shown are available upon request.

When ordering, please follow the example below:





<b>Inch:</b>	7-63/64", 130° CPM-M4 (H8 series) = use Part No. <b>10294-7.9843</b>
<b>Decimal:</b>	6.391", 130° CPM-M4 (H5 series) = use Part No. <b>10294-6.3910</b>

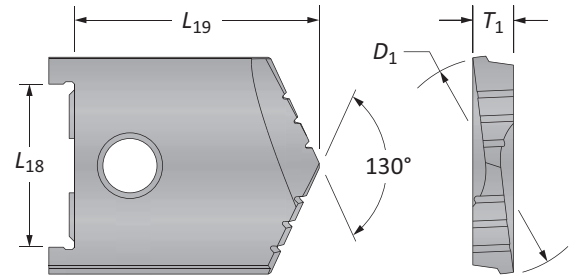

## Universal Spade Drill Inserts

C Series | Diameter Range: 1.5000" - 2.3750"



Series	D <sub>1</sub> inch		Insert						
	Fraction	Decimal	L <sub>18</sub>	L <sub>19</sub>	T <sub>1</sub>	130° CPM-M4	130° CPM-T15*	Flat Bottom	90° Spot & Chamfer
C	1-1/2	1.5000	1-1/4	2	5/16	10234-0116	10235-0116	10434-0116	POR
	1-17/32	1.5313	1-1/4	2	5/16	10234-0117	-	-	POR
	1-9/16	1.5625	1-1/4	2	5/16	10234-0118	10235-0118	10434-0118	POR
	1-19/32	1.5938	1-1/4	2	5/16	10234-0119	-	-	POR
	1-5/8	1.6250	1-1/4	2	5/16	10234-0120	10235-0120	10434-0120	POR
	1-21/32	1.6563	1-1/4	2	5/16	10234-0121	-	-	POR
	1-11/16	1.6875	1-1/4	2	5/16	10234-0122	10235-0122	10434-0122	POR
	1-23/32	1.7188	1-1/4	2	5/16	10234-0123	-	-	POR
	1-3/4	1.7500	1-1/4	2	5/16	10234-0124	10235-0124	10434-0124	POR
	1-25/32	1.7813	1-1/4	2	5/16	10234-0125	-	-	POR
	1-13/16	1.8125	1-1/4	2	5/16	10234-0126	10235-0126	10434-0126	POR
	1-27/32	1.8438	1-1/4	2	5/16	10234-0127	-	-	POR
	1-7/8	1.8750	1-1/4	2	5/16	10234-0128	10235-0128	10434-0128	POR
	1-29/32	1.9063	1-1/4	2	5/16	10234-0129	-	-	POR
	1-15/16	1.9375	1-1/4	2	5/16	10234-0130	10235-0130	10434-0130	POR
	1-31/32	1.9688	1-1/4	2	5/16	10234-0131	-	-	POR
	2	2.0000	1-1/4	2	5/16	10234-0200	10235-0200	10434-0200	11234-0200
C Oversize	2-1/32	2.0313	1-1/4	2	5/16	10234-0201	-	-	-
	2-1/16	2.0625	1-1/4	2	5/16	10234-0202	-	-	-
	2-3/32	2.0938	1-1/4	2	5/16	10234-0203	-	-	-
	2-1/8	2.1250	1-1/4	2	5/16	10234-0204	-	-	-
	2-5/32	2.1563	1-1/4	2	5/16	10234-0205	-	-	-
	2-3/16	2.1875	1-1/4	2	5/16	10234-0206	-	-	-
	2-7/32	2.2188	1-1/4	2	5/16	10234-0207	-	-	-
	2-1/4	2.2500	1-1/4	2	5/16	10234-0208	-	-	-
	2-9/32	2.2813	1-1/4	2	5/16	10234-0209	-	-	-
	2-5/16	2.3125	1-1/4	2	5/16	10234-0210	-	-	-
	2-11/32	2.3438	1-1/4	2	5/16	10234-0211	-	-	-
	2-3/8	2.3750	1-1/4	2	5/16	10234-0212	-	-	-

\*Discontinued | NOTE: POR = Priced on request

Flat Bottom

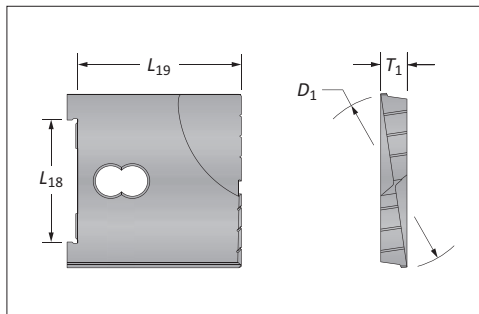

90° Spot & Chamfer

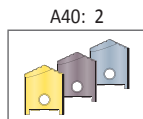
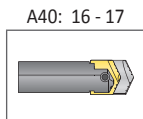
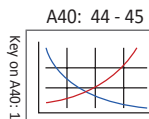
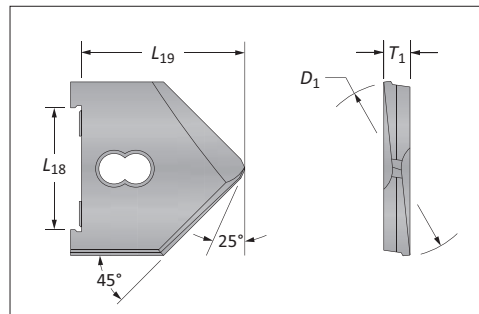

Sizes not shown are available upon request.  
When ordering, please follow the example below:

Inch:	1-17/64", 130° CPM-M4 (B series) = use Part No. 10224-1.2656
Decimal:	1.5110", 130° Flat Bottom (C series) = use Part No. 10434-1.5110

A  
DRILLING  
B  
BORING  
C  
REAMING  
D  
BURNISHING  
E  
THREADING  
X  
SPECIALS



## High Performance / Universal Spade Drill Insert Holders

## C Series

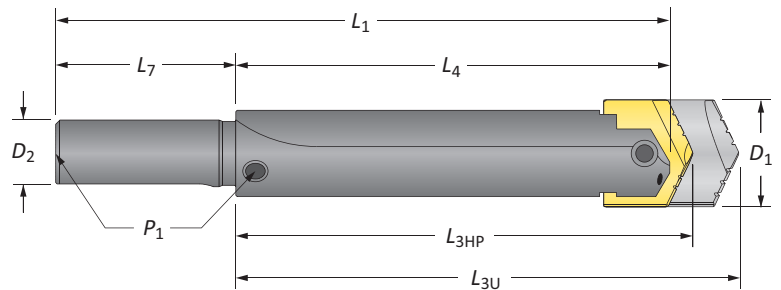

## Straight Shank

Length	$D_1$	Holder				Shank				Style	Part No.
		$L_{3HP}$	$L_{3U}$	$L_4$	$L_1$	$D_2$	$L_7$	$P_1$			
Stub	1-1/2 - 2-3/8	2-19/64	3	2	6	1-1/2	4	-	#125	20231-1500	
Short	1-1/2 - 2-3/8	4-19/64	5	4	8	1-1/4	4	-	#150	20431-1250	
Short	1-1/2 - 2-3/8	4-19/64	5	4	8	1-1/4	4	1/4	#100	20631-1250	
<b>i</b> Short	1-1/2 - 2-3/8	4-19/64	5	4	8	1-1/2	4	1/4	#100	20631-1500	
Standard	1-1/2 - 2-3/8	8-51/64	9-1/2	8-1/2	12-1/2	1-1/4	4	1/4	#200	20831-1250	
Standard	1-1/2 - 2-3/8	8-51/64	9-1/2	8-1/2	12-1/2	1-1/2	4	1/4	#200	20831-1500	
Long	1-1/2 - 2-3/8	18-19/64	19	18	22	1-1/2	4	1/4	#250	<b>21031-1500</b>	

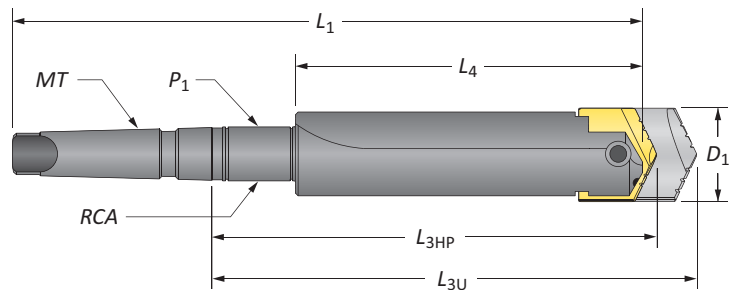

## Taper Shank

Length	$D_1$	Holder				Shank				Style	Part No.
		$L_{3HP}$	$L_{3U}$	$L_4$	$L_1$	MT	$P_1$	RCA			
Short	1-1/2 - 2-3/8	4-35/64	5-1/4	4	8-7/8	#4	-	-	#300	21431-0004	
Short	1-1/2 - 2-3/8	4-35/64	5-1/4	4	8-7/8	#4	-	-	#300 TSC	21531-0004*	
Short	1-1/2 - 2-3/8	4-35/64	5-1/4	4	10-1/8	#5	-	-	#300 TSC	21531-0005*	
Short	1-1/2 - 2-3/8	6-15/64	6-15/64	4	10-9/16	#4	1/4	2T-4SR	#400 SR	21631-0004	
<b>i</b> Standard	1-1/2 - 2-3/8	10-47/64	11-7/16	8-1/2	15-1/16	#4	1/4	2T-4SR	#500 SR	21831-0004	
Standard	1-1/2 - 2-3/8	10-47/64	11-7/16	8-1/2	16-5/16	#5	1/4	2T-5SR	#500 SR	21831-0005	
Long	1-1/2 - 2-3/8	20-15/64	20-5/16	18	24-9/16	#4	1/4	2T-4SR	#600 SR	<b>22031-0004</b>	
Long	1-1/2 - 2-3/8	20-15/64	20-5/16	18	25-13/16	#5	1/4	2T-5SR	#600 SR	<b>22031-0005</b>	
XL	1-1/2 - 2-3/8	28-15/64	28-15/16	26	32-9/16	#4	1/4	2T-4SR	#700 SR	<b>22231-0004</b>	
XL	1-1/2 - 2-3/8	28-15/64	28-15/16	26	33-13/16	#5	1/4	2T-5SR	#700 SR	<b>22231-0005</b>	

\*Through shank coolant, coolant inlet diameter = 5/16"

## Connection Accessories



Clamping Screw

1/4"-20 x 1



Blade-Loc Screw

-

A40: 14 - 15



**i** = Imperial (in)  
**m** = Metric (mm)

**WARNING** Refer to Speed and Feed charts for recommended adjustments to speeds and feeds. Refer to page A40: 48 for deep hole drilling guidelines in this section of the catalog. Visit [www.alliedmachine.com/DeepHoleGuidelines](http://www.alliedmachine.com/DeepHoleGuidelines) for the most up-to-date information and procedures. Factory technical assistance is available for your specific applications through our Application Engineering Team.

## High Performance / Universal Spade Drill Insert Holders

### C Series

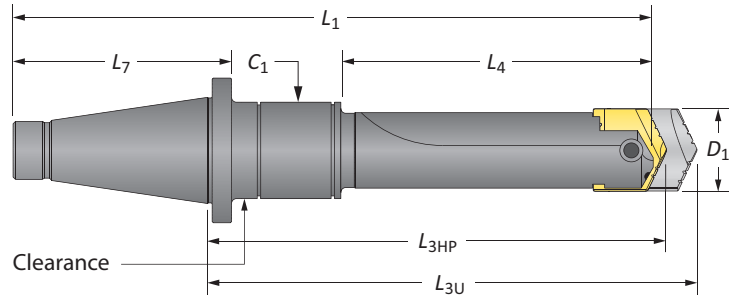

#### 50 NMTB Shank\*

Length	D <sub>1</sub>	Holder				Shank					Part No.
		L <sub>3HP</sub>	L <sub>3U</sub>	L <sub>4</sub>	L <sub>1</sub>	NMTB	L <sub>7</sub>	C <sub>1</sub>	RCA	Style	
i Short	1-1/2 - 2-3/8	5-27/64	6-1/8	4	10-1/8	50	5-5/8	-	-	#300	<b>22431-0050</b>
	1-1/2 - 2-3/8	7-7/64	7-13/16	4	11-13/16	50	5-5/8	3/8	2T-5SR	#400	<b>22631-0050</b>
	1-1/2 - 2-3/8	11-39/64	12-5/16	8-1/2	16-5/16	50	5-5/8	3/8	2T-5SR	#500	<b>22831-0050</b>

\*All NMTB shank holders are discontinued items. Items listed are available (subject to prior sale) at list prices until stock is depleted. Once stock is depleted, items are available as quoted specials only.

#### Rotary Coolant Adapter (RCA) and Accessories

ID	OD	L <sub>1</sub>	Driving Rod Thread	P <sub>1</sub>	Part No.*	RCA O-Rings	
						Kit Part No.**	Replacements
i 1-1/4	2-1/2	1-3/8	3/8 - NC	1/4	<b>2T-4SR</b>	2T1-4SR	2T1-4OR-10
	3	1-3/8	3/8 - NC	1/4	<b>2T-5SR</b>	2T1-5SR	2T1-5OR-10

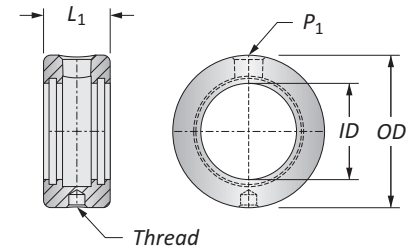



\*RCA comes complete with (1) RCA, (2) O-rings, (2) snap rings, and (2) thrust washers

\*\*RCA Repair Kit includes (2) O-rings, (2) snap rings, and (2) thrust washers

▲ Refer to page A40: 40 for proper RCA assembly and safety information

#### Connection Accessories

	
<b>Clamping Screw</b>	<b>Blade-Loc Screw</b>
1/4"-20 x 1	-

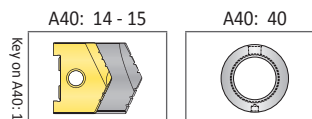

i = Imperial (in)  
m = Metric (mm)  
O-rings sold in packs of 10

**WARNING** RCA rotation during drilling can cause hose and/or hose fitting failure, machinery damage, and/or serious injury. To prevent, use RCA and positive stop studs when drilling. Factory technical assistance is also available for your specific applications.



## High Performance Spade Drill Inserts

D Series | Diameter Range: 2.0000" - 2.8750"

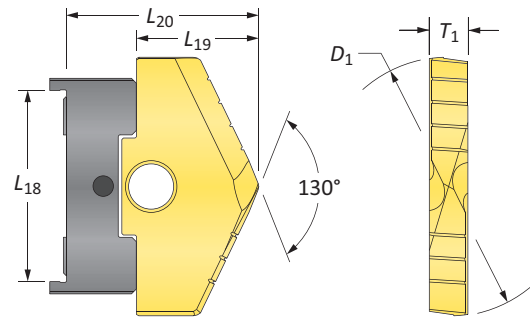
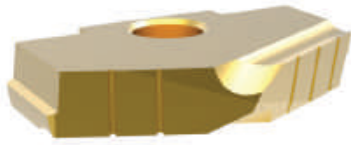

Series	D <sub>1</sub> inch		Insert				TiN Part No.	TiAlN Part No.	TiCN Part No.	Adapter
	Fraction	Decimal	L <sub>18</sub>	L <sub>19</sub>	L <sub>20</sub>	T <sub>1</sub>				
D	2	2.0000	1-3/4	1-3/16	1-55/64	3/8	1024T-0200	1024A-0200	1024N-0200	1024U-Adapter
	2-1/32	2.0313	1-3/4	1-3/16	1-55/64	3/8	1024T-0201	1024A-0201	1024N-0201	1024U-Adapter
	2-1/16	2.0625	1-3/4	1-3/16	1-55/64	3/8	1024T-0202	1024A-0202	1024N-0202	1024U-Adapter
	2-3/32	2.0938	1-3/4	1-3/16	1-55/64	3/8	1024T-0203	1024A-0203	1024N-0203	1024U-Adapter
	2-1/8	2.1250	1-3/4	1-3/16	1-55/64	3/8	1024T-0204	1024A-0204	1024N-0204	1024U-Adapter
	2-5/32	2.1563	1-3/4	1-3/16	1-55/64	3/8	1024T-0205	1024A-0205	1024N-0205	1024U-Adapter
	2-3/16	2.1875	1-3/4	1-3/16	1-55/64	3/8	1024T-0206	1024A-0206	1024N-0206	1024U-Adapter
	2-7/32	2.2188	1-3/4	1-3/16	1-55/64	3/8	1024T-0207	1024A-0207	1024N-0207	1024U-Adapter
	2-1/4	2.2500	1-3/4	1-3/16	1-55/64	3/8	1024T-0208	1024A-0208	1024N-0208	1024U-Adapter
	2-9/32	2.2813	1-3/4	1-3/16	1-55/64	3/8	1024T-0209	1024A-0209	1024N-0209	1024U-Adapter
	2-5/16	2.3125	1-3/4	1-3/16	1-55/64	3/8	1024T-0210	1024A-0210	1024N-0210	1024U-Adapter
	2-11/32	2.3438	1-3/4	1-3/16	1-55/64	3/8	1024T-0211	1024A-0211	1024N-0211	1024U-Adapter
	2-3/8	2.3750	1-3/4	1-3/16	1-55/64	3/8	1024T-0212	1024A-0212	1024N-0212	1024U-Adapter
	2-13/32	2.4063	1-3/4	1-3/16	1-55/64	3/8	1024T-0213	1024A-0213	1024N-0213	1024U-Adapter
	2-7/16	2.4375	1-3/4	1-3/16	1-55/64	3/8	1024T-0214	1024A-0214	1024N-0214	1024U-Adapter
	2-15/32	2.4688	1-3/4	1-3/16	1-55/64	3/8	1024T-0215	1024A-0215	1024N-0215	1024U-Adapter
2-1/2	2.5000	1-3/4	1-3/16	1-55/64	3/8	1024T-0216	1024A-0216	1024N-0216	1024U-Adapter	
D Oversize	2-17/32	2.5313	1-3/4	1-3/16	1-55/64	3/8	1024T-0217	1024A-0217	1024N-0217	1024U-Adapter
	2-9/16	2.5625	1-3/4	1-3/16	1-55/64	3/8	1024T-0218	1024A-0218	1024N-0218	1024U-Adapter
	2-19/32	2.5938	1-3/4	1-3/16	1-55/64	3/8	1024T-0219	1024A-0219	1024N-0219	1024U-Adapter
	2-5/8	2.6250	1-3/4	1-3/16	1-55/64	3/8	1024T-0220	1024A-0220	1024N-0220	1024U-Adapter
	2-21/32	2.6563	1-3/4	1-3/16	1-55/64	3/8	1024T-0221	1024A-0221	1024N-0221	1024U-Adapter
	2-11/16	2.6875	1-3/4	1-3/16	1-55/64	3/8	1024T-0222	1024A-0222	1024N-0222	1024U-Adapter
	2-23/32	6.7188	1-3/4	1-3/16	1-55/64	3/8	1024T-0223	1024A-0223	1024N-0223	1024U-Adapter
	2-3/4	6.7500	1-3/4	1-3/16	1-55/64	3/8	1024T-0224	1024A-0224	1024N-0224	1024U-Adapter
	2-25/35	6.7813	1-3/4	1-3/16	1-55/64	3/8	1024T-0225	1024A-0225	1024N-0225	1024U-Adapter
	2-13/16	2.8125	1-3/4	1-3/16	1-55/64	3/8	1024T-0226	1024A-0226	1024N-0226	1024U-Adapter
	2-27/32	2.8438	1-3/4	1-3/16	1-55/64	3/8	1024T-0227	1024A-0227	1024N-0227	1024U-Adapter
	2-7/8	2.8750	1-3/4	1-3/16	1-55/64	3/8	1024T-0228	1024A-0228	1024N-0228	1024U-Adapter

**NOTE:** Adapter is required for D-H series High Performance spade drills. Adapters sold separately.

Inserts sold in multiples of 1

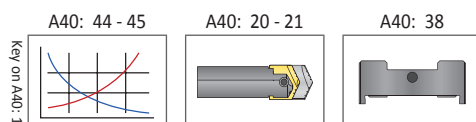

Sizes not shown are available upon request.





When ordering, please follow the example below:

<b>Inch:</b>	7-63/64", 130° CPM-M4 (H8 series) = use Part No. <b>10294-7.9843</b>
<b>Decimal:</b>	6.391", 130° CPM-M4 (H5 series) = use Part No. <b>10294-6.3910</b>

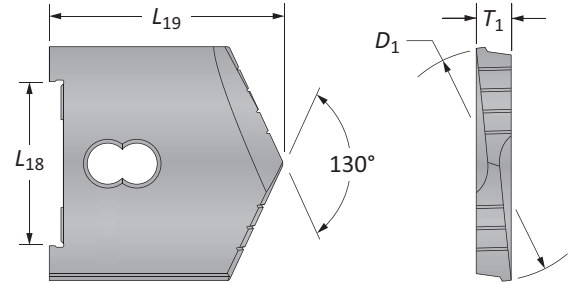
## Universal Spade Drill Inserts

D Series | Diameter Range: 2.0000" - 2.8750"



Series	D <sub>1</sub> inch		Insert						
	Fraction	Decimal	L <sub>18</sub>	L <sub>19</sub>	T <sub>1</sub>	130° CPM-M4	130° CPM-T15*	Flat Bottom	90° Spot & Chamfer
D	2	2.0000	1-3/4	2-3/8	3/8	10244-0200	-	10444-0200	POR
	2-1/32	2.0313	1-3/4	2-3/8	3/8	10244-0201	-	-	POR
	2-1/16	2.0625	1-3/4	2-3/8	3/8	10244-0202	10245-0202	10444-0202	POR
	2-3/32	2.0938	1-3/4	2-3/8	3/8	10244-0203	-	-	POR
	2-1/8	2.1250	1-3/4	2-3/8	3/8	10244-0204	-	10444-0204	POR
	2-5/32	2.1563	1-3/4	2-3/8	3/8	10244-0205	-	-	POR
	2-3/16	2.1875	1-3/4	2-3/8	3/8	10244-0206	10245-0206	10444-0206	POR
	2-7/32	2.2188	1-3/4	2-3/8	3/8	10244-0207	-	-	POR
	2-1/4	2.2500	1-3/4	2-3/8	3/8	10244-0208	-	10444-0208	POR
	2-9/32	2.2813	1-3/4	2-3/8	3/8	10244-0209	-	-	POR
	2-5/16	2.3125	1-3/4	2-3/8	3/8	10244-0210	10245-0210	10444-0210	POR
	2-11/32	2.3438	1-3/4	2-3/8	3/8	10244-0211	-	-	POR
	2-3/8	2.3750	1-3/4	2-3/8	3/8	10244-0212	-	10444-0212	POR
	2-13/32	2.4063	1-3/4	2-3/8	3/8	10244-0213	-	-	POR
	2-7/16	2.4375	1-3/4	2-3/8	3/8	10244-0214	10245-0214	10444-0214	POR
	2-15/32	2.4688	1-3/4	2-3/8	3/8	10244-0215	-	-	POR
2-1/2	2.5000	1-3/4	2-3/8	3/8	10244-0216	-	10444-0216	11244-0216	
D Oversize	2-17/32	2.5313	1-3/4	2-3/8	3/8	10244-0217	-	-	-
	2-9/16	2.5625	1-3/4	2-3/8	3/8	10244-0218	-	-	-
	2-19/32	2.5938	1-3/4	2-3/8	3/8	10244-0219	-	-	-
	2-5/8	2.6250	1-3/4	2-3/8	3/8	10244-0220	-	-	-
	2-21/32	2.6563	1-3/4	2-3/8	3/8	10244-0221	-	-	-
	2-11/16	2.6875	1-3/4	2-3/8	3/8	10244-0222	-	-	-
	2-23/32	2.7188	1-3/4	2-3/8	3/8	10244-0223	-	-	-
	2-3/4	2.7500	1-3/4	2-3/8	3/8	10244-0224	-	-	-
	2-25/32	2.7813	1-3/4	2-3/8	3/8	10244-0225	-	-	-
	2-13/16	2.8125	1-3/4	2-3/8	3/8	10244-0226	-	-	-
	2-27/32	2.8438	1-3/4	2-3/8	3/8	10244-0227	-	-	-
	2-7/8	2.8750	1-3/4	2-3/8	3/8	10244-0228	-	-	-

\*Discontinued | NOTE: POR = Priced on request

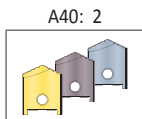
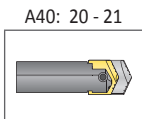
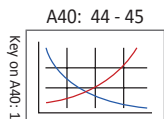
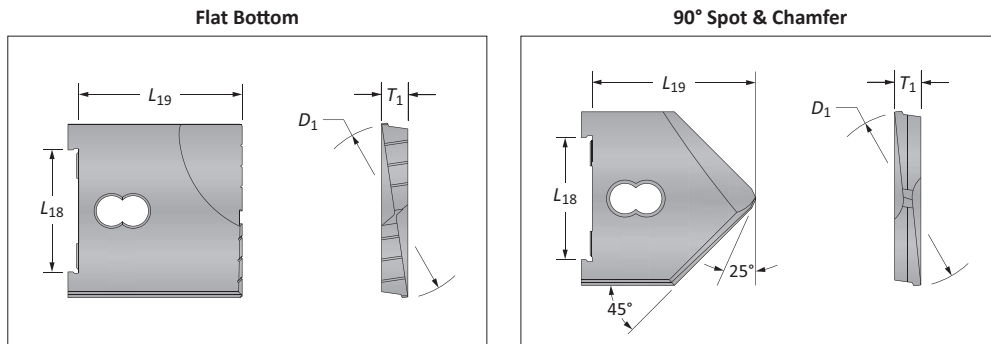

Sizes not shown are available upon request.  
When ordering, please follow the example below:

<b>Inch:</b>	1-17/64", 130° CPM-M4 (B series) = use Part No. <b>10224-1.2656</b>
<b>Decimal:</b>	1.5110", 130° Flat Bottom (C series) = use Part No. <b>10434-1.5110</b>



## High Performance / Universal Spade Drill Insert Holders

## D Series

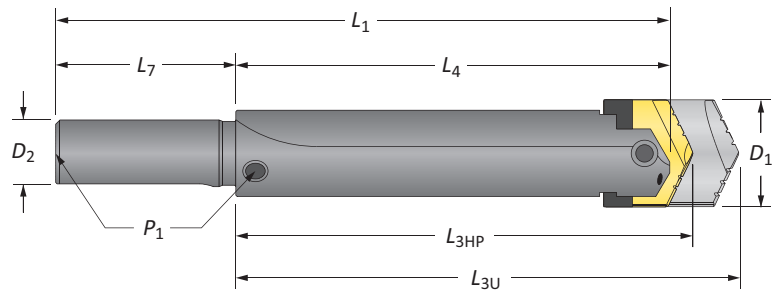

## Straight Shank

Length	D <sub>1</sub>	Holder				Shank				Style	Part No.
		L <sub>3HP</sub>	L <sub>3U</sub>	L <sub>4</sub>	L <sub>1</sub>	D <sub>2</sub>	L <sub>7</sub>	P <sub>1</sub>			
Stub	2 - 2-7/8	2-19/64	3	2	6	1-1/2	4	-	#125	<b>20241-1500</b>	
Short	2 - 2-7/8	4-63/64	5-1/2	4-1/2	8-1/2	1-1/2	4	-	#150	<b>20441-1500</b>	
Short	2 - 2-7/8	4-63/64	5-1/2	4-1/2	8-1/2	1-1/2	4	1/4	#100	<b>20641-1500</b>	
Standard	2 - 2-7/8	9-31/64	10	9	13	1-1/2	4	1/4	#200	<b>20841-1500</b>	
Long	2 - 2-7/8	18-31/64	19	18	22	1-1/2	4	1/4	#250	<b>21041-1500</b>	

NOTE: Adapter is required for D-H series High Performance spade drills. Adapters sold separately.

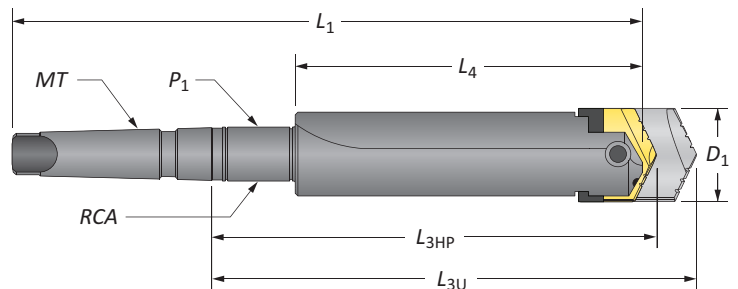



## Taper Shank

Length	D <sub>1</sub>	Holder				Shank				Style	Part No.
		L <sub>3HP</sub>	L <sub>3U</sub>	L <sub>4</sub>	L <sub>1</sub>	MT	P <sub>1</sub>	RCA			
Short	2 - 2-7/8	5-15/64	5-3/4	4-1/2	9-3/8	#4	-	-	#300	<b>21441-0004</b>	
Short	2 - 2-7/8	5-15/64	5-3/4	4-1/2	10-5/8	#5	-	-	#300	<b>21441-0005</b>	
Short	2 - 2-7/8	5-15/64	5-3/4	4-1/2	9-3/8	#4	-	-	#300 TSC	<b>21541-0004*</b>	
Short	2 - 2-7/8	6-59/64	7-7/16	4-1/2	11-1/16	#4	1/4	2T-4SR	#400 SR	<b>21641-0004</b>	
Standard	2 - 2-7/8	11-27/64	11-15/16	9	15-9/16	#4	1/4	2T-4SR	#500 SR	<b>21841-0004</b>	
Standard	2 - 2-7/8	11-27/64	11-15/16	9	16-13/16	#5	1/4	2T-5SR	#500 SR	<b>21841-0005</b>	
Long	2 - 2-7/8	20-27/64	20-15/16	18	24-9/16	#4	1/4	2T-4SR	#600 SR	<b>22041-0004</b>	
Long	2 - 2-7/8	20-27/64	20-15/16	18	25-13/16	#5	1/4	2T-5SR	#600 SR	<b>22041-0005</b>	
XL	2 - 2-7/8	30-27/64	30-15/16	28	34-9/16	#4	1/4	2T-4SR	#700 SR	<b>22241-0004</b>	
XL	2 - 2-7/8	30-27/64	30-15/16	28	35-13/16	#5	1/4	2T-5SR	#700 SR	<b>22241-0005</b>	

\*Through shank coolant, coolant inlet diameter = 5/16"

NOTE: Adapter is required for D-H series High Performance spade drills. Adapters sold separately.

## Connection Accessories

	
<b>Clamping Screw</b>	<b>Blade-Loc Screw</b>
3/8"-16 x 1-1/4"	5/16"-18 x 1/2"

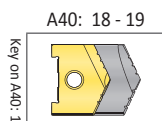

**i** = Imperial (in)  
**m** = Metric (mm)

**WARNING** Refer to Speed and Feed charts for recommended adjustments to speeds and feeds. Refer to page A40: 48 for deep hole drilling guidelines in this section of the catalog. Visit [www.alliedmachine.com/DeepHoleGuidelines](http://www.alliedmachine.com/DeepHoleGuidelines) for the most up-to-date information and procedures. Factory technical assistance is available for your specific applications through our Application Engineering Team.

## High Performance / Universal Spade Drill Insert Holders

D Series

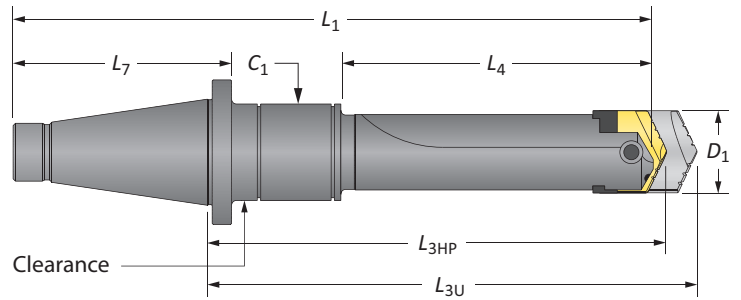

50 NMTB Shank\*

Length	D <sub>1</sub>	Holder				Shank					Part No.
		L <sub>3HP</sub>	L <sub>3U</sub>	L <sub>4</sub>	L <sub>1</sub>	NMTB	L <sub>7</sub>	C <sub>1</sub>	RCA	Style	
Short	2 - 2-7/8	9-27/64	9-15/16	5-1/2	13-15/16	50	5-5/8	3/8	2T-55SR	#400	<b>22641-0050</b>
	2 - 2-7/8	15-27/64	15-15/16	11-1/2	19-15/16	50	5-5/8	3/8	2T-55SR	#500	<b>22841-0050</b>

\*All NMTB shank holders are discontinued items. Items listed are available (subject to prior sale) at list prices until stock is depleted. Once stock is depleted, items are available as quoted specials only.

### Rotary Coolant Adapter (RCA) and Accessories

ID	OD	L <sub>1</sub>	Driving Rod Thread	P <sub>1</sub>	Part No.*	RCA O-Rings	
						Kit Part No.**	Replacements
1-1/4	2-1/2	1-3/8	3/8 - NC	1/4	<b>2T-4SR</b>	2T1-4SR	2T1-4OR-10
1-3/4	3	1-3/8	3/8 - NC	1/4	<b>2T-5SR</b>	2T1-5SR	2T1-5OR-10
2-1/2	4	1-3/4	1/2 - NC	1/2	<b>2T-55SR</b>	2T1-55SR	2T1-55OR-10

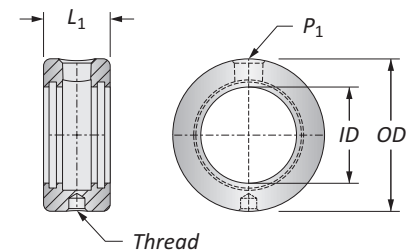

\*RCA comes complete with (1) RCA, (2) O-rings, (2) snap rings, and (2) thrust washers

\*\*RCA Repair Kit includes (2) O-rings, (2) snap rings, and (2) thrust washers

▲ Refer to page A40: 40 for proper RCA assembly and safety information

### Connection Accessories

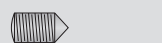
	
<b>Clamping Screw</b>	<b>Blade-Loc Screw</b>
3/8"-16 x 1-1/4"	5/16"-18 x 1/2"

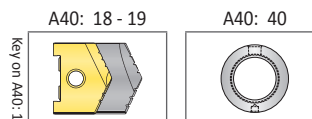

ⓘ = Imperial (in)  
 ⓘ = Metric (mm)  
 O-rings sold in packs of 10

**WARNING** RCA rotation during drilling can cause hose and/or hose fitting failure, machinery damage, and/or serious injury. To prevent, use RCA and positive stop studs when drilling. Factory technical assistance is also available for your specific applications.

## High Performance Spade Drill Inserts

E Series | Diameter Range: 2.5000" - 3.3750"

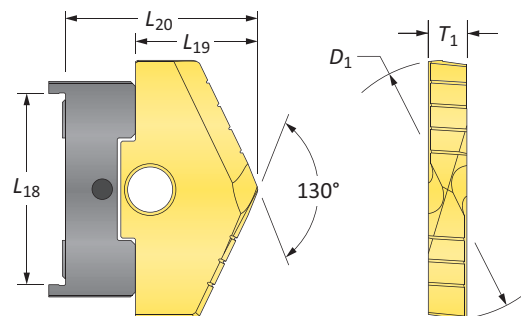
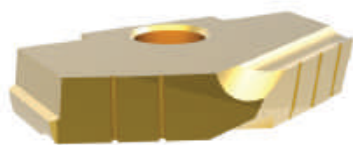

Series	D <sub>1</sub> inch		Inserts				TiN Part No.	TiAlN Part No.	TiCN Part No.	Adapter
	Fraction	Decimal	L <sub>18</sub>	L <sub>19</sub>	L <sub>20</sub>	T <sub>1</sub>				
E	2-1/2	2.5000	2-1/16	1-7/16	2-3/32	7/16	1025T-0216	1025A-0216	1025N-0216	1025U-Adapter
	2-17/32	2.5313	2-1/16	1-7/16	2-3/32	7/16	1025T-0217	1025A-0217	1025N-0217	1025U-Adapter
	2-9/16	2.5625	2-1/16	1-7/16	2-3/32	7/16	1025T-0218	1025A-0218	1025N-0218	1025U-Adapter
	2-19/32	2.5938	2-1/16	1-7/16	2-3/32	7/16	1025T-0219	1025A-0219	1025N-0219	1025U-Adapter
	2-5/8	2.6250	2-1/16	1-7/16	2-3/32	7/16	1025T-0220	1025A-0220	1025N-0220	1025U-Adapter
	2-21/32	2.6563	2-1/16	1-7/16	2-3/32	7/16	1025T-0221	1025A-0221	1025N-0221	1025U-Adapter
	2-11/16	2.6875	2-1/16	1-7/16	2-3/32	7/16	1025T-0222	1025A-0222	1025N-0222	1025U-Adapter
	2-23/32	2.7188	2-1/16	1-7/16	2-3/32	7/16	1025T-0223	1025A-0223	1025N-0223	1025U-Adapter
	2-3/4	2.7500	2-1/16	1-7/16	2-3/32	7/16	1025T-0224	1025A-0224	1025N-0224	1025U-Adapter
	2-25/32	2.7813	2-1/16	1-7/16	2-3/32	7/16	1025T-0225	1025A-0225	1025N-0225	1025U-Adapter
	2-13/16	2.8125	2-1/16	1-7/16	2-3/32	7/16	1025T-0226	1025A-0226	1025N-0226	1025U-Adapter
	2-27/32	2.8438	2-1/16	1-7/16	2-3/32	7/16	1025T-0227	1025A-0227	1025N-0227	1025U-Adapter
	2-7/8	2.8750	2-1/16	1-7/16	2-3/32	7/16	1025T-0228	1025A-0228	1025N-0228	1025U-Adapter
	2-29/32	2.9063	2-1/16	1-7/16	2-3/32	7/16	1025T-0229	1025A-0229	1025N-0229	1025U-Adapter
	2-15/16	2.9375	2-1/16	1-7/16	2-3/32	7/16	1025T-0230	1025A-0230	1025N-0230	1025U-Adapter
2-31/32	2.9688	2-1/16	1-7/16	2-3/32	7/16	1025T-0231	1025A-0231	1025N-0231	1025U-Adapter	
3	3.0000	2-1/16	1-7/16	2-3/32	7/16	1025T-0300	1025A-0300	1025N-0300	1025U-Adapter	
E Oversize	3-1/32	3.0313	2-1/16	1-7/16	2-3/32	7/16	1025T-0301	1025A-0301	1025N-0301	1025U-Adapter
	3-1/16	3.0625	2-1/16	1-7/16	2-3/32	7/16	1025T-0302	1025A-0302	1025N-0302	1025U-Adapter
	3-3/32	3.0938	2-1/16	1-7/16	2-3/32	7/16	1025T-0303	1025A-0303	1025N-0303	1025U-Adapter
	3-1/8	3.1250	2-1/16	1-7/16	2-3/32	7/16	1025T-0304	1025A-0304	1025N-0304	1025U-Adapter
	3-5/32	3.1563	2-1/16	1-7/16	2-3/32	7/16	1025T-0305	1025A-0305	1025N-0305	1025U-Adapter
	3-3/16	3.1875	2-1/16	1-7/16	2-3/32	7/16	1025T-0306	1025A-0306	1025N-0306	1025U-Adapter
	3-7/32	3.2188	2-1/16	1-7/16	2-3/32	7/16	1025T-0307	1025A-0307	1025N-0307	1025U-Adapter
	3-1/4	3.2500	2-1/16	1-7/16	2-3/32	7/16	1025T-0308	1025A-0308	1025N-0308	1025U-Adapter
	3-9/32	3.2813	2-1/16	1-7/16	2-3/32	7/16	1025T-0309	1025A-0309	1025N-0309	1025U-Adapter
	3-5/16	3.3125	2-1/16	1-7/16	2-3/32	7/16	1025T-0310	1025A-0310	1025N-0310	1025U-Adapter
	3-11/32	3.3438	2-1/16	1-7/16	2-3/32	7/16	1025T-0311	1025A-0311	1025N-0311	1025U-Adapter
	3-3/8	3.3750	2-1/16	1-7/16	2-3/32	7/16	1025T-0312	1025A-0312	1025N-0312	1025U-Adapter

**NOTE:** Adapter is required for D-H series High Performance spade drills. Adapters sold separately.

Inserts sold in multiples of 1

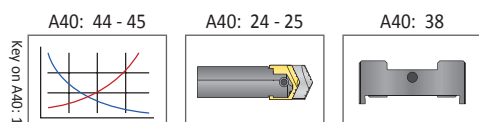

Sizes not shown are available upon request.

When ordering, please follow the example below:

<b>Inch:</b>	7-63/64", 130° CPM-M4 (H8 series) = use Part No. <b>10294-7.9843</b>
<b>Decimal:</b>	6.391", 130° CPM-M4 (H5 series) = use Part No. <b>10294-6.3910</b>





## Universal Spade Drill Inserts

E Series | Diameter Range: 2.5000" - 3.3750"

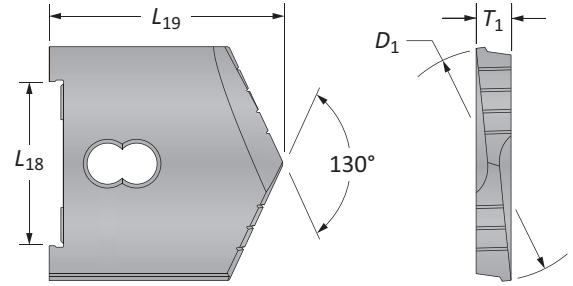

Series	D <sub>1</sub> inch		Inserts						
	Fraction	Decimal	L <sub>18</sub>	L <sub>19</sub>	T <sub>1</sub>	130° CPM-M4	130° CPM-T15*	Flat Bottom	90° Spot & Chamfer
E	2-1/2	2.5000	2-1/16	2-5/8	7/16	10254-0216	10255-0216	10454-0216	POR
	2-17/32	2.5313	2-1/16	2-5/8	7/16	10254-0217	-	-	POR
	2-9/16	2.5625	2-1/16	2-5/8	7/16	10254-0218	10255-0218	10454-0218	POR
	2-19/32	2.5938	2-1/16	2-5/8	7/16	10254-0219	-	-	POR
	2-5/8	2.6250	2-1/16	2-5/8	7/16	10254-0220	10255-0220	10454-0220	POR
	2-21/32	2.6563	2-1/16	2-5/8	7/16	10254-0221	-	-	POR
	2-11/16	2.6875	2-1/16	2-5/8	7/16	10254-0222	10255-0222	10454-0222	POR
	2-23/32	2.7188	2-1/16	2-5/8	7/16	10254-0223	-	-	POR
	2-3/4	2.7500	2-1/16	2-5/8	7/16	10254-0224	10255-0224	10454-0224	POR
	2-25/32	2.7813	2-1/16	2-5/8	7/16	10254-0225	-	-	POR
	2-13/16	2.8125	2-1/16	2-5/8	7/16	10254-0226	10255-0226	10454-0226	POR
	2-27/32	2.8438	2-1/16	2-5/8	7/16	10254-0227	-	-	POR
	2-7/8	2.8750	2-1/16	2-5/8	7/16	10254-0228	10255-0228	10454-0228	POR
	2-29/32	2.9063	2-1/16	2-5/8	7/16	10254-0229	-	-	POR
	2-15/16	2.9375	2-1/16	2-5/8	7/16	10254-0230	10255-0230	10454-0230	POR
	2-31/32	2.9688	2-1/16	2-5/8	7/16	10254-0231	-	-	POR
3	3.0000	2-1/16	2-5/8	7/16	10254-0300	10255-0300	10454-0300	11254-0300	
E Oversize	3-1/32	3.0313	2-1/16	2-5/8	7/16	10254-0301	-	-	-
	3-1/16	3.0625	2-1/16	2-5/8	7/16	10254-0302	-	-	-
	3-3/32	3.0938	2-1/16	2-5/8	7/16	10254-0303	-	-	-
	3-1/8	3.1250	2-1/16	2-5/8	7/16	10254-0304	-	-	-
	3-5/32	3.1563	2-1/16	2-5/8	7/16	10254-0305	-	-	-
	3-3/16	3.1875	2-1/16	2-5/8	7/16	10254-0306	-	-	-
	3-7/32	3.2188	2-1/16	2-5/8	7/16	10254-0307	-	-	-
	3-1/4	3.2500	2-1/16	2-5/8	7/16	10254-0308	-	-	-
	3-9/32	3.2813	2-1/16	2-5/8	7/16	10254-0309	-	-	-
	3-5/16	3.3125	2-1/16	2-5/8	7/16	10254-0310	-	-	-
	3-11/32	3.3438	2-1/16	2-5/8	7/16	10254-0311	-	-	-
	3-3/8	3.3750	2-1/16	2-5/8	7/16	10254-0312	-	-	-

\*Discontinued | NOTE: POR = Priced on request

Flat Bottom

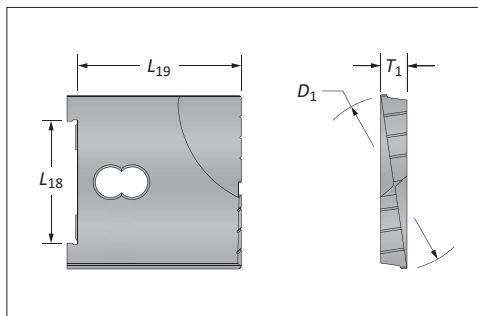

90° Spot & Chamfer

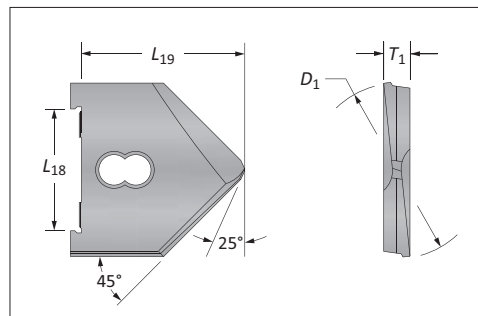

A40: 44 - 45

A40: 24 - 25

A40: 2

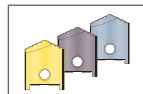
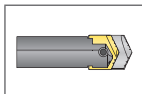
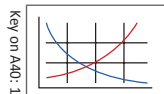

Sizes not shown are available upon request.  
When ordering, please follow the example below:

<b>Inch:</b>	1-17/64", 130° CPM-M4 (B series) = use Part No. <b>10224-1.2656</b>
<b>Decimal:</b>	1.5110", 130° Flat Bottom (C series) = use Part No. <b>10434-1.5110</b>

## High Performance / Universal Spade Drill Insert Holders

### E Series

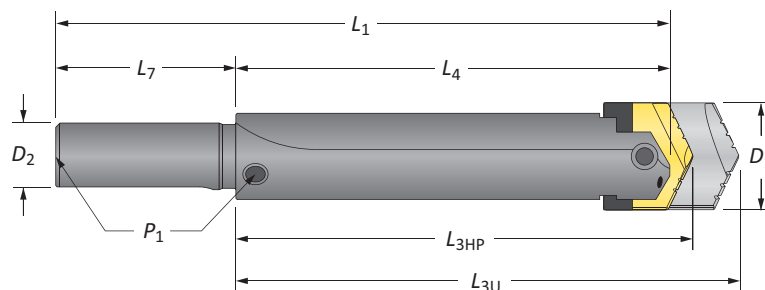

#### Straight Shank

Length	$D_1$	Insert				Shank				Part No.
		$L_{3HP}$	$L_{3U}$	$L_4$	$L_1$	$D_2$	$L_7$	$P_1$	Style	
Stub	2-1/2 - 3-3/8	3-1/32	3-9/16	2-1/2	6-1/2	2	4	–	#125	<b>20251-2000</b>
Short	2-1/2 - 3-3/8	5-17/32	6-1/16	5	9	1-3/4	4	–	#150	<b>20451-1750</b>
<b>i</b> Short	2-1/2 - 3-3/8	5-17/32	6-1/16	5	9	1-3/4	4	1/2	#100	<b>20651-1750</b>
Standard	2-1/2 - 3-3/8	10-17/32	11-1/16	10	14	2	4	1/2	#200	<b>20851-2000</b>
Long	2-1/2 - 3-3/8	20-17/32	21-1/16	20	24	2	4	1/2	#250	<b>21051-2000</b>

**NOTE:** Adapter is required for D-H series High Performance spade drills. Adapters sold separately.

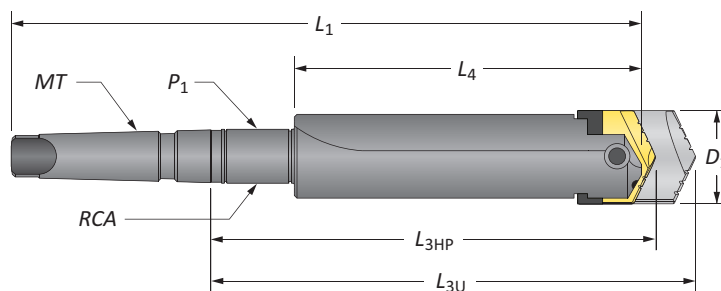



#### Taper Shank

Length	$D_1$	Holder				Shank				Part No.
		$L_{3HP}$	$L_{3U}$	$L_4$	$L_1$	MT	$P_1$	RCA	Style	
Short	2-1/2 - 3-3/8	5-25/32	6-5/16	5	9-7/8	#4	–	–	#300	<b>21451-0004</b>
Short	2-1/2 - 3-3/8	5-25/32	6-5/16	5	11-1/8	#5	–	–	#300	<b>21451-0005</b>
Short	2-1/2 - 3-3/8	5-25/32	6-5/16	5	11-1/8	#5	–	–	#300 TSC	<b>21551-0005*</b>
<b>i</b> Short	2-1/2 - 3-3/8	8-3/32	8-5/8	5	13-7/16	#5	1/2	2T-6SR	#400 SR	<b>21651-0005</b>
Standard	2-1/2 - 3-3/8	13-3/32	13-5/8	10	18-7/16	#5	1/2	2T-6SR	#500 SR	<b>21851-0005</b>
Long	2-1/2 - 3-3/8	23-3/32	23-5/8	20	28-7/16	#5	1/2	2T-6SR	#600 SR	<b>22051-0005</b>
XL	2-1/2 - 3-3/8	33-3/32	33-5/8	30	38-7/16	#5	1/2	2T-6SR	#700 SR	<b>22251-0005</b>

\*Through shank coolant, coolant inlet diameter = 3/8"

**NOTE:** Adapter is required for D-H series High Performance spade drills. Adapters sold separately.

#### Connection Accessories

	
<b>Clamping Screw</b>	<b>Blade-Loc Screw</b>
1/2"-13 x 1-3/4"	5/16"-18 x 1/2"

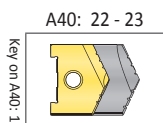

A40: 22 - 23

Key on A40: 1

**i** = Imperial (in)  
**m** = Metric (mm)

**WARNING** Refer to Speed and Feed charts for recommended adjustments to speeds and feeds. Refer to page A40: 48 for deep hole drilling guidelines in this section of the catalog. Visit [www.alliedmachine.com/DeepHoleGuidelines](http://www.alliedmachine.com/DeepHoleGuidelines) for the most up-to-date information and procedures. Factory technical assistance is available for your specific applications through our Application Engineering Team.

## High Performance / Universal Spade Drill Insert Holders

E Series

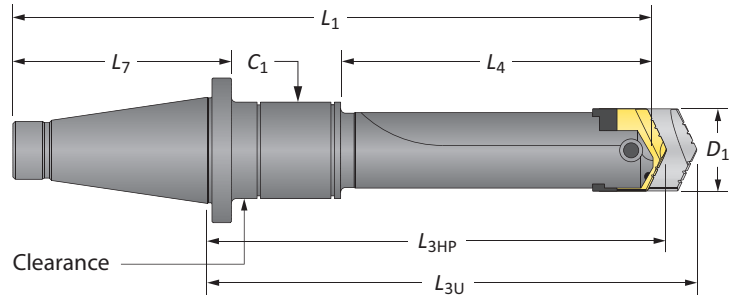

50 NMTB Shank\*

Length	D <sub>1</sub>	Holders				Shank					Part No.
		L <sub>3HP</sub>	L <sub>3U</sub>	L <sub>4</sub>	L <sub>1</sub>	NMTB	L <sub>7</sub>	C <sub>1</sub>	RCA	Style	
Short	2-1/2 - 3-3/8	9-15/32	10	5-1/2	13-15/16	50	5-5/8	5/8	2T-55SR	#400	<b>22651-0050</b>
	2-1/2 - 3-3/8	15-15/32	16	11-1/2	19-15/16	50	5-5/8	5/8	2T-55SR	#500	<b>22851-0050</b>

\*All NMTB shank holders are discontinued items. Items listed are available (subject to prior sale) at list prices until stock is depleted. Once stock is depleted, items are available as quoted specials only.

### Rotary Coolant Adapter (RCA) and Accessories

ID	OD	L <sub>1</sub>	Driving Rod Thread	P <sub>1</sub>	Part No.*	RCA O-Rings	
						Kit Part No.**	Replacements
2-1/4	3-3/4	1-3/4	1/2 - NC	1/2	▲ 2T-6SR	2T1-6SR	2T1-6OR-10
							2T1-55SR
2-1/2	4	1-3/4	1/2 - NC	1/2	▲ 2T-55SR	2T1-55SR	2T1-55OR-10

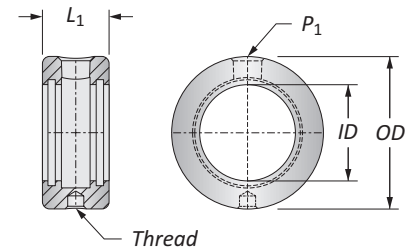



\*RCA comes complete with (1) RCA, (2) O-rings, (2) snap rings, and (2) thrust washers

\*\*RCA Repair Kit includes (2) O-rings, (2) snap rings, and (2) thrust washers

▲ Refer to page A40: 40 for proper RCA assembly and safety information

### Connection Accessories

	
<b>Clamping Screw</b>	<b>Blade-Loc Screw</b>
1/2"-13 x 1-3/4"	5/16"-18 x 1/2"

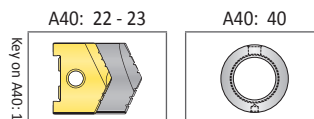

ⓘ = Imperial (in)  
 ⓘ = Metric (mm)  
 O-rings sold in packs of 10

**⚠ WARNING** RCA rotation during drilling can cause hose and/or hose fitting failure, machinery damage, and/or serious injury. To prevent, use RCA and positive stop studs when drilling. Factory technical assistance is also available for your specific applications.

## High Performance Spade Drill Inserts

F Series | Diameter Range: 3.0000" - 3.8750"

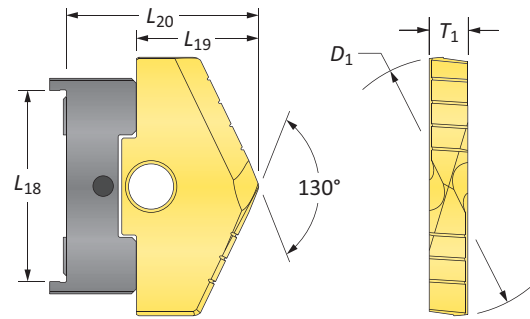
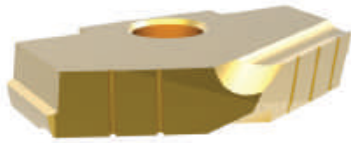

Series	D <sub>1</sub> inch		Insert				TiN Part No.	TiAlN Part No.	TiCN Part No.	Adapter
	Fraction	Decimal	L <sub>18</sub>	L <sub>19</sub>	L <sub>20</sub>	T <sub>1</sub>				
F	3	3.0000	2-5/8	1-13/16	2-17/32	1/2	1026T-0300	1026A-0300	1026N-0300	1026U-Adapter
	3-1/32	3.0313	2-5/8	1-13/16	2-17/32	1/2	1026T-0301	1026A-0301	1026N-0301	1026U-Adapter
	3-1/16	3.0625	2-5/8	1-13/16	2-17/32	1/2	1026T-0302	1026A-0302	1026N-0302	1026U-Adapter
	3-3/32	3.0938	2-5/8	1-13/16	2-17/32	1/2	1026T-0303	1026A-0303	1026N-0303	1026U-Adapter
	3-1/8	3.1250	2-5/8	1-13/16	2-17/32	1/2	1026T-0304	1026A-0304	1026N-0304	1026U-Adapter
	3-5/32	3.1563	2-5/8	1-13/16	2-17/32	1/2	1026T-0305	1026A-0305	1026N-0305	1026U-Adapter
	3-3/16	3.1875	2-5/8	1-13/16	2-17/32	1/2	1026T-0306	1026A-0306	1026N-0306	1026U-Adapter
	3-7/32	3.2188	2-5/8	1-13/16	2-17/32	1/2	1026T-0307	1026A-0307	1026N-0307	1026U-Adapter
	3-1/4	3.2500	2-5/8	1-13/16	2-17/32	1/2	1026T-0308	1026A-0308	1026N-0308	1026U-Adapter
	3-9/32	3.2813	2-5/8	1-13/16	2-17/32	1/2	1026T-0309	1026A-0309	1026N-0309	1026U-Adapter
	3-5/16	3.3125	2-5/8	1-13/16	2-17/32	1/2	1026T-0310	1026A-0310	1026N-0310	1026U-Adapter
	3-11/32	3.3438	2-5/8	1-13/16	2-17/32	1/2	1026T-0311	1026A-0311	1026N-0311	1026U-Adapter
	3-3/8	3.3750	2-5/8	1-13/16	2-17/32	1/2	1026T-0312	1026A-0312	1026N-0312	1026U-Adapter
	3-13/32	3.4063	2-5/8	1-13/16	2-17/32	1/2	1026T-0313	1026A-0313	1026N-0313	1026U-Adapter
	3-7/16	3.4375	2-5/8	1-13/16	2-17/32	1/2	1026T-0314	1026A-0314	1026N-0314	1026U-Adapter
	3-15/32	3.4688	2-5/8	1-13/16	2-17/32	1/2	1026T-0315	1026A-0315	1026N-0315	1026U-Adapter
3-1/2	3.5000	2-5/8	1-13/16	2-17/32	1/2	1026T-0316	1026A-0316	1026N-0316	1026U-Adapter	
F Oversize	3-17/32	3.5313	2-5/8	1-13/16	2-17/32	1/2	1026T-0317	1026A-0317	1026N-0317	1026U-Adapter
	3-9/16	3.5625	2-5/8	1-13/16	2-17/32	1/2	1026T-0318	1026A-0318	1026N-0318	1026U-Adapter
	3-19/32	3.5938	2-5/8	1-13/16	2-17/32	1/2	1026T-0319	1026A-0319	1026N-0319	1026U-Adapter
	3-5/8	3.6250	2-5/8	1-13/16	2-17/32	1/2	1026T-0320	1026A-0320	1026N-0320	1026U-Adapter
	3-21/32	3.6563	2-5/8	1-13/16	2-17/32	1/2	1026T-0321	1026A-0321	1026N-0321	1026U-Adapter
	3-11/16	3.6875	2-5/8	1-13/16	2-17/32	1/2	1026T-0322	1026A-0322	1026N-0322	1026U-Adapter
	3-23/32	3.7188	2-5/8	1-13/16	2-17/32	1/2	1026T-0323	1026A-0323	1026N-0323	1026U-Adapter
	3-3/4	3.7500	2-5/8	1-13/16	2-17/32	1/2	1026T-0324	1026A-0324	1026N-0324	1026U-Adapter
	3-25/32	3.7813	2-5/8	1-13/16	2-17/32	1/2	1026T-0325	1026A-0325	1026N-0325	1026U-Adapter
	3-13/16	3.8125	2-5/8	1-13/16	2-17/32	1/2	1026T-0326	1026A-0326	1026N-0326	1026U-Adapter
	3-27/32	3.8438	2-5/8	1-13/16	2-17/32	1/2	1026T-0327	1026A-0327	1026N-0327	1026U-Adapter
	3-7/8	3.8750	2-5/8	1-13/16	2-17/32	1/2	1026T-0328	1026A-0328	1026N-0328	1026U-Adapter

**NOTE:** Adapter is required for D-H series High Performance spade drills. Adapters sold separately.

Inserts sold in multiples of 1

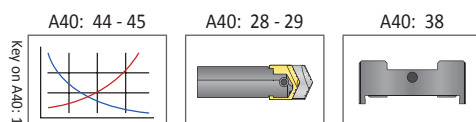

Sizes not shown are available upon request.

When ordering, please follow the example below:

<b>Inch:</b>	7-63/64", 130° CPM-M4 (H8 series) = use Part No. <b>10294-7.9843</b>
<b>Decimal:</b>	6.391", 130° CPM-M4 (H5 series) = use Part No. <b>10294-6.3910</b>



## Universal Spade Drill Inserts

F Series | Diameter Range: 3.0000" - 3.8750"

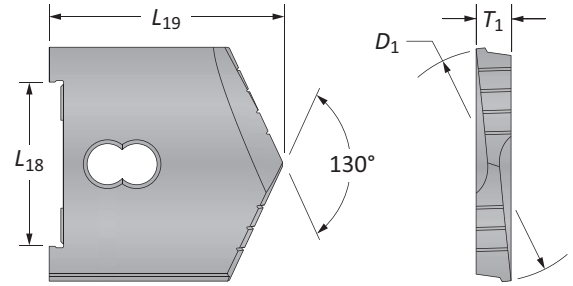

Series	D <sub>1</sub> inch		Insert						
	Fraction	Decimal	L <sub>18</sub>	L <sub>19</sub>	T <sub>1</sub>	130° CPM-M4	130° CPM-T15*	Flat Bottom	90° Spot & Chamfer
F	3	3.0000	2-5/8	3-1/8	1/2	10264-0300	10265-0300	10464-0300	POR
	3-1/32	3.0313	2-5/8	3-1/8	1/2	10264-0301	-	-	POR
	3-1/16	3.0625	2-5/8	3-1/8	1/2	10264-0302	10265-0302	10464-0302	POR
	3-3/32	3.0938	2-5/8	3-1/8	1/2	10264-0303	-	-	POR
	3-1/8	3.1250	2-5/8	3-1/8	1/2	10264-0304	10265-0304	10464-0304	POR
	3-5/32	3.1563	2-5/8	3-1/8	1/2	10264-0305	-	-	POR
	3-3/16	3.1875	2-5/8	3-1/8	1/2	10264-0306	10265-0306	10464-0306	POR
	3-7/32	3.2188	2-5/8	3-1/8	1/2	10264-0307	-	-	POR
	3-1/4	3.2500	2-5/8	3-1/8	1/2	10264-0308	-	-	POR
	3-9/32	3.2813	2-5/8	3-1/8	1/2	10264-0309	-	-	POR
	3-5/16	3.3125	2-5/8	3-1/8	1/2	10264-0310	10265-0310	10464-0310	POR
	3-11/32	3.3438	2-5/8	3-1/8	1/2	10264-0311	-	-	POR
	3-3/8	3.3750	2-5/8	3-1/8	1/2	10264-0312	-	-	POR
	3-13/32	3.4063	2-5/8	3-1/8	1/2	10264-0313	-	-	POR
	3-7/16	3.4375	2-5/8	3-1/8	1/2	10264-0314	10265-0314	10464-0314	POR
	3-15/32	3.4688	2-5/8	3-1/8	1/2	10264-0315	-	-	POR
3-1/2	3.5000	2-5/8	3-1/8	1/2	10264-0316	-	10464-0316	11264-0316	
F Oversize	3-17/32	3.5313	2-5/8	3-1/8	1/2	10264-0317	-	-	-
	3-9/16	3.5625	2-5/8	3-1/8	1/2	10264-0318	-	-	-
	3-19/32	3.5938	2-5/8	3-1/8	1/2	10264-0319	-	-	-
	3-5/8	3.6250	2-5/8	3-1/8	1/2	10264-0320	-	-	-
	3-21/32	3.6563	2-5/8	3-1/8	1/2	10264-0321	-	-	-
	3-11/16	3.6875	2-5/8	3-1/8	1/2	10264-0322	-	-	-
	3-23/32	3.7188	2-5/8	3-1/8	1/2	10264-0323	-	-	-
	3-3/4	3.7500	2-5/8	3-1/8	1/2	10264-0324	-	-	-
	3-25/32	3.7813	2-5/8	3-1/8	1/2	10264-0325	-	-	-
	3-13/16	3.8125	2-5/8	3-1/8	1/2	10264-0326	-	-	-
	3-27/32	3.8438	2-5/8	3-1/8	1/2	10264-0327	-	-	-
	3-7/8	3.8750	2-5/8	3-1/8	1/2	10264-0328	-	-	-

\*Discontinued | NOTE: POR = Priced on request

Flat Bottom

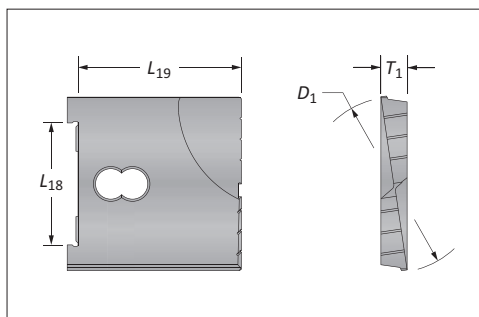

90° Spot & Chamfer

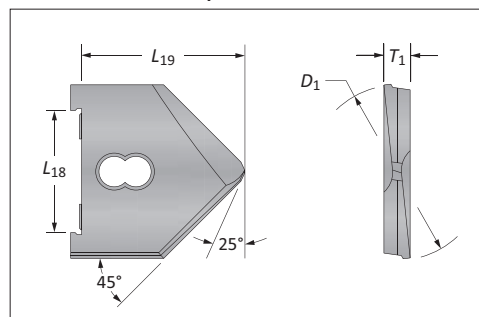

A40: 44 - 45

A40: 28 - 29

A40: 2

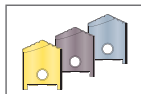
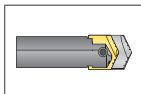
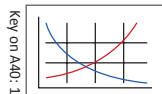

Sizes not shown are available upon request.  
When ordering, please follow the example below:

Inch:	1-17/64", 130° CPM-M4 (B series) = use Part No. 10224-1.2656
Decimal:	1.5110", 130° Flat Bottom (C series) = use Part No. 10434-1.5110

## High Performance / Universal Spade Drill Insert Holders

### F Series

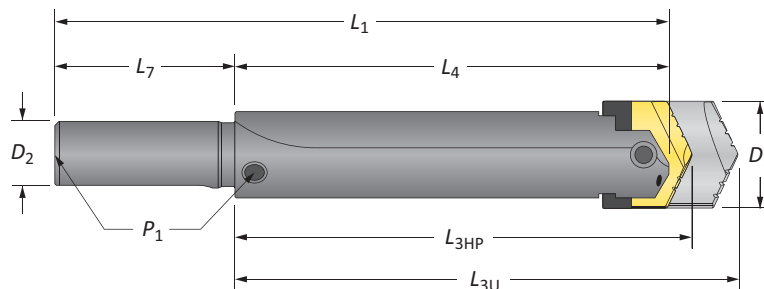

#### Straight Shank

Length	$D_1$	Holder				Shank				Style	Part No.
		$L_{3HP}$	$L_{3U}$	$L_4$	$L_1$	$D_2$	$L_7$	$P_1$			
Stub	3 - 3-7/8	3-13/32	4	2-3/4	6-3/4	2-1/2	4	-	#125	<b>20261-2500</b>	
Short	3 - 3-7/8	6-5/32	6-3/4	5-1/2	9-1/2	2	4	-	#150	<b>20461-2000</b>	
Short	3 - 3-7/8	6-5/32	6-3/4	5-1/2	9-1/2	2	4	1/2	#100	<b>20661-2000</b>	
Short	3 - 3-7/8	6-5/32	6-3/4	5-1/2	9-1/2	2-1/2	4	1/2	#100	<b>20661-2500</b>	
Standard	3 - 3-7/8	12-5/32	12-3/4	11-1/2	15-1/2	2	4	1/2	#200	<b>20861-2000</b>	
Long	3 - 3-7/8	20-21/32	21-1/4	20	24	2-1/2	4	1/2	#250	<b>21061-2500</b>	

**NOTE:** Adapter is required for D-H series High Performance spade drills. Adapters sold separately.

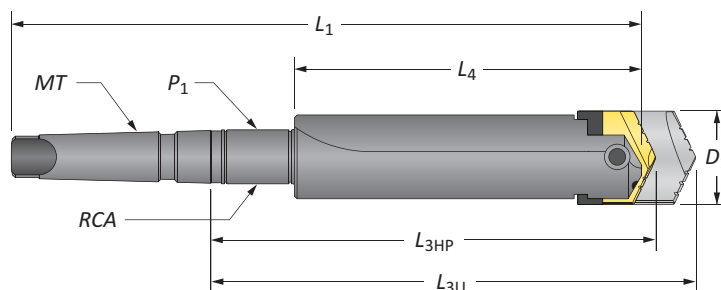

#### Taper Shank

Length	$D_1$	Holder				Shank				Style	Part No.
		$L_{3HP}$	$L_{3U}$	$L_4$	$L_1$	MT	$P_1$	RCA			
Short	3 - 3-7/8	6-13/32	7	5-1/2	11-5/8	#5	-	-	#300	<b>21461-0005</b>	
Short	3 - 3-7/8	6-13/32	7	5-1/2	11-5/8	#5	-	-	#300 TSC	<b>21561-0005*</b>	
Short	3 - 3-7/8	8-23/32	9-5/16	5-1/2	13-15/16	#5	1/2	2T-6SR	#400 SR	<b>21661-0005</b>	
Standard	3 - 3-7/8	14-23/32	15-5/16	11-1/2	19-15/16	#5	1/2	2T-6SR	#500 SR	<b>21861-0005</b>	
Long	3 - 3-7/8	23-7/32	23-13/16	20	28-7/16	#5	1/2	2T-6SR	#600 SR	<b>22061-0005</b>	
XL	3 - 3-7/8	36-7/32	36-13/16	33	41-7/16	#5	1/2	2T-6SR	#700 SR	<b>22261-0005</b>	

\*Through shank coolant, coolant inlet diameter = 3/8"

**NOTE:** Adapter is required for D-H series High Performance spade drills. Adapters sold separately.

#### Connection Accessories

<p><b>Clamping Screw</b> 1/2"-13 x 1-3/4"</p>	<p><b>Blade-Loc Screw</b> 5/16"-18 x 1/2"</p>
---	---

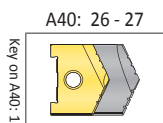

**i** = Imperial (in)  
**m** = Metric (mm)

**WARNING** Refer to Speed and Feed charts for recommended adjustments to speeds and feeds. Refer to page A40: 48 for deep hole drilling guidelines in this section of the catalog. Visit [www.alliedmachine.com/DeepHoleGuidelines](http://www.alliedmachine.com/DeepHoleGuidelines) for the most up-to-date information and procedures. Factory technical assistance is available for your specific applications through our Application Engineering Team.

## High Performance / Universal Spade Drill Insert Holders

F Series

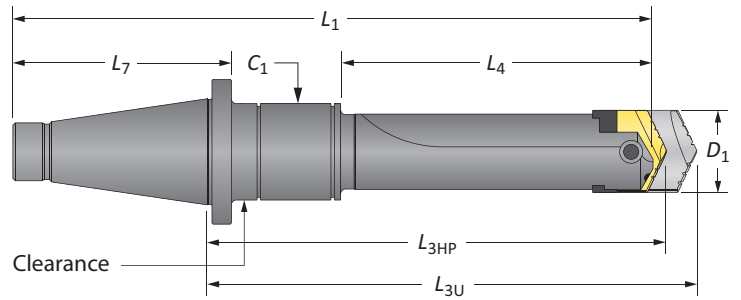

50 NMTB Shank\*

Length	D <sub>1</sub>	Holder				Shank					Part No.
		L <sub>3HP</sub>	L <sub>3U</sub>	L <sub>4</sub>	L <sub>1</sub>	NMTB	L <sub>7</sub>	C <sub>1</sub>	RCA	Style	
Short	3 - 3-7/8	7-9/32	7-7/8	5-1/2	11-5/8	50	5-5/8	–	–	#300	<b>22461-0050</b>
Short	3 - 3-7/8	9-19/32	10-3/16	5-1/2	13-15/16	50	5-5/8	5/8	2T-60SR	#400	<b>22661-0050</b>
Short	3 - 3-7/8	15-19/32	16-3/16	11-1/2	19-15/16	50	5-5/8	5/8	2T-60SR	#500	<b>22861-0050</b>

\*All NMTB shank holders are discontinued items. Items listed are available (subject to prior sale) at list prices until stock is depleted. Once stock is depleted, items are available as quoted specials only.

### Rotary Coolant Adapter (RCA) and Accessories

ID	OD	L <sub>1</sub>	Driving Rod Thread	P <sub>1</sub>	Part No.*	RCA O-Rings	
						Kit Part No.**	Replacements
2-1/4	3-3/4	1-3/4	1/2 - NC	1/2	<b>2T-6SR</b>	2T1-6SR	2T1-6OR-10
3	4-1/2	1-3/4	1/2 - NC	1/2	<b>2T-6OSR</b>	2T1-6OSR	2T1-6OOR-10

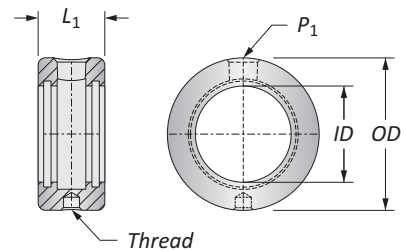



\*RCA comes complete with (1) RCA, (2) O-rings, (2) snap rings, and (2) thrust washers

\*\*RCA Repair Kit includes (2) O-rings, (2) snap rings, and (2) thrust washers

▲ Refer to page A40: 40 for proper RCA assembly and safety information

### Connection Accessories

	
<b>Clamping Screw</b>	<b>Blade-Loc Screw</b>
1/2"-13 x 1-3/4"	5/16"-18 x 1/2"

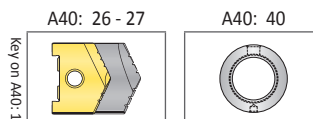

ⓘ = Imperial (in)  
 ⓘ = Metric (mm)  
 O-rings sold in packs of 10

**⚠ WARNING** RCA rotation during drilling can cause hose and/or hose fitting failure, machinery damage, and/or serious injury. To prevent, use RCA and positive stop studs when drilling. Factory technical assistance is also available for your specific applications.

## High Performance Spade Drill Inserts

G Series | Diameter Range: 3.5000" - 4.5000"

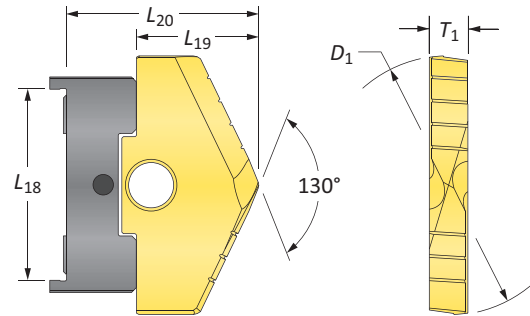
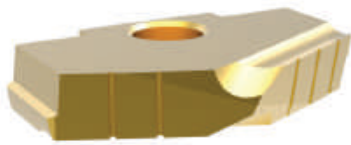

Series	D <sub>1</sub> inch		Insert				TiN Part No.	TiAlN Part No.	TiCN Part No.	Adapter
	Fraction	Decimal	L <sub>18</sub>	L <sub>19</sub>	L <sub>20</sub>	T <sub>1</sub>				
G	3-1/2	3.5000	3-1/16	1-15/16	2-23/32	5/8	1027T-0316	1027A-0316	1027N-0316	1027U-Adapter
	3-17/32	3.5313	3-1/16	1-15/16	2-23/32	5/8	1027T-0317	1027A-0317	1027N-0317	1027U-Adapter
	3-9/16	3.5625	3-1/16	1-15/16	2-23/32	5/8	1027T-0318	1027A-0318	1027N-0318	1027U-Adapter
	3-19/32	3.5938	3-1/16	1-15/16	2-23/32	5/8	1027T-0319	1027A-0319	1027N-0319	1027U-Adapter
	3-5/8	3.6250	3-1/16	1-15/16	2-23/32	5/8	1027T-0320	1027A-0320	1027N-0320	1027U-Adapter
	3-21/32	3.6563	3-1/16	1-15/16	2-23/32	5/8	1027T-0321	1027A-0321	1027N-0321	1027U-Adapter
	3-11/16	3.6875	3-1/16	1-15/16	2-23/32	5/8	1027T-0322	1027A-0322	1027N-0322	1027U-Adapter
	3-23/32	3.7188	3-1/16	1-15/16	2-23/32	5/8	1027T-0323	1027A-0323	1027N-0323	1027U-Adapter
	3-3/4	3.7500	3-1/16	1-15/16	2-23/32	5/8	1027T-0324	1027A-0324	1027N-0324	1027U-Adapter
	3-25/32	3.7813	3-1/16	1-15/16	2-23/32	5/8	1027T-0325	1027A-0325	1027N-0325	1027U-Adapter
	3-13/16	3.8125	3-1/16	1-15/16	2-23/32	5/8	1027T-0326	1027A-0326	1027N-0326	1027U-Adapter
	3-27/32	3.8438	3-1/16	1-15/16	2-23/32	5/8	1027T-0327	1027A-0327	1027N-0327	1027U-Adapter
	3-7/8	3.8750	3-1/16	1-15/16	2-23/32	5/8	1027T-0328	1027A-0328	1027N-0328	1027U-Adapter
	3-29/32	3.9063	3-1/16	1-15/16	2-23/32	5/8	1027T-0329	1027A-0329	1027N-0329	1027U-Adapter
	3-15/16	3.9375	3-1/16	1-15/16	2-23/32	5/8	1027T-0330	1027A-0330	1027N-0330	1027U-Adapter
3-31/32	3.9688	3-1/16	1-15/16	2-23/32	5/8	1027T-0331	1027A-0331	1027N-0331	1027U-Adapter	
4	4.0000	3-1/16	1-15/16	2-23/32	5/8	1027T-0400	1027A-0400	1027N-0400	1027U-Adapter	
G Oversize	4-1/16	4.0625	3-1/16	1-15/16	2-23/32	5/8	1027T-0402	1027A-0402	1027N-0402	1027U-Adapter
	4-1/8	4.1250	3-1/16	1-15/16	2-23/32	5/8	1027T-0404	1027A-0404	1027N-0404	1027U-Adapter
	4-3/16	4.1875	3-1/16	1-15/16	2-23/32	5/8	1027T-0406	1027A-0406	1027N-0406	1027U-Adapter
	4-1/4	4.2500	3-1/16	1-15/16	2-23/32	5/8	1027T-0408	1027A-0408	1027N-0408	1027U-Adapter
	4-5/16	4.3125	3-1/16	1-15/16	2-23/32	5/8	1027T-0410	1027A-0410	1027N-0410	1027U-Adapter
	4-3/8	4.3750	3-1/16	1-15/16	2-23/32	5/8	1027T-0412	1027A-0412	1027N-0412	1027U-Adapter
	4-7/16	4.4375	3-1/16	1-15/16	2-23/32	5/8	1027T-0414	1027A-0414	1027N-0414	1027U-Adapter
4-1/2	4.5000	3-1/16	1-15/16	2-23/32	5/8	1027T-0416	1027A-0416	1027N-0416	1027U-Adapter	

NOTE: Adapter is required for D-H series High Performance spade drills. Adapters sold separately.

Inserts sold in multiples of 1

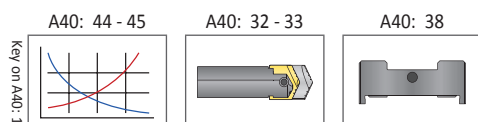

Sizes not shown are available upon request.

When ordering, please follow the example below:

Inch:	7-63/64", 130° CPM-M4 (H8 series) = use Part No. <b>10294-7.9843</b>
Decimal:	6.391", 130° CPM-M4 (H5 series) = use Part No. <b>10294-6.3910</b>





## Universal Spade Drill Inserts

G Series | Diameter Range: 3.5000" - 4.5000"

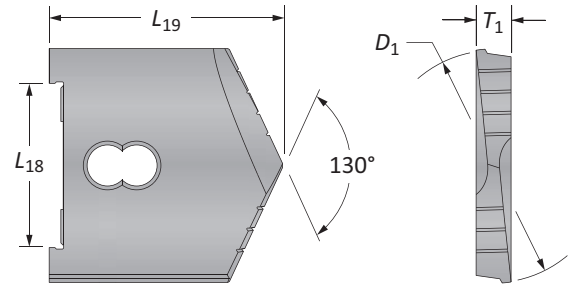

Series	D <sub>1</sub> inch		Insert					
	Fraction	Decimal	L <sub>18</sub>	L <sub>19</sub>	T <sub>1</sub>	130° CPM-M4	130° CPM-T15*	Flat Bottom
G	3-1/2	3.5000	3-1/16	3-3/8	5/8	10274-0316	10275-0316	10474-0316
	3-17/32	3.5313	3-1/16	3-3/8	5/8	10274-0317	-	-
	3-9/16	3.5625	3-1/16	3-3/8	5/8	10274-0318	10275-0318	10474-0318
	3-19/32	3.5938	3-1/16	3-3/8	5/8	10274-0319	-	-
	3-5/8	3.6250	3-1/16	3-3/8	5/8	10274-0320	10275-0320	10474-0320
	3-21/32	3.6563	3-1/16	3-3/8	5/8	10274-0321	-	-
	3-11/16	3.6875	3-1/16	3-3/8	5/8	10274-0322	10275-0322	10474-0322
	3-23/32	3.7188	3-1/16	3-3/8	5/8	10274-0323	-	-
	3-3/4	3.7500	3-1/16	3-3/8	5/8	10274-0324	10275-0324	10474-0324
	3-25/32	3.7813	3-1/16	3-3/8	5/8	10274-0325	-	-
	3-13/16	3.8125	3-1/16	3-3/8	5/8	10274-0326	10275-0326	10474-0326
	3-27/32	3.8438	3-1/16	3-3/8	5/8	10274-0327	-	-
	3-7/8	3.8750	3-1/16	3-3/8	5/8	10274-0328	10275-0328	10474-0328
	3-29/32	3.9063	3-1/16	3-3/8	5/8	10274-0329	-	-
	3-15/16	3.9375	3-1/16	3-3/8	5/8	10274-0330	10275-0330	10474-0330
3-31/32	3.9688	3-1/16	3-3/8	5/8	10274-0331	-	-	
4	4.0000	3-1/16	3-3/8	5/8	10274-0400	10275-0400	10474-0400	
G Oversize	4-1/16	4.0625	3-1/16	3-3/8	5/8	10274-0402	-	-
	4-1/8	4.1250	3-1/16	3-3/8	5/8	10274-0404	-	-
	4-3/16	4.1875	3-1/16	3-3/8	5/8	10274-0406	-	-
	4-1/4	4.2500	3-1/16	3-3/8	5/8	10274-0408	-	-
	4-5/16	4.3125	3-1/16	3-3/8	5/8	10274-0410	-	-
	4-3/8	4.3750	3-1/16	3-3/8	5/8	10274-0412	-	-
	4-7/16	4.4375	3-1/16	3-3/8	5/8	10274-0414	-	-
4-1/2	4.5000	3-1/16	3-3/8	5/8	10274-0416	-	-	

\*Discontinued

Inserts sold in multiples of 1

NOTE: POR = Priced on request

Flat Bottom

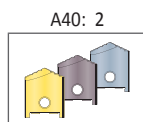
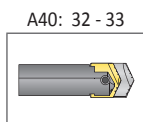
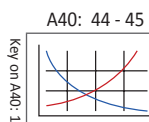
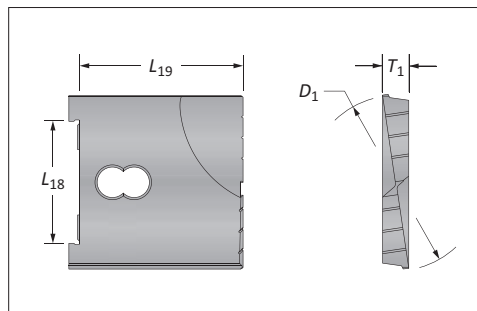

Sizes not shown are available upon request.  
When ordering, please follow the example below:

Inch:	1-17/64", 130° CPM-M4 (B series) = use Part No. 10224-1.2656
Decimal:	1.5110", 130° Flat Bottom (C series) = use Part No. 10434-1.5110

## High Performance / Universal Spade Drill Insert Holders

## G Series

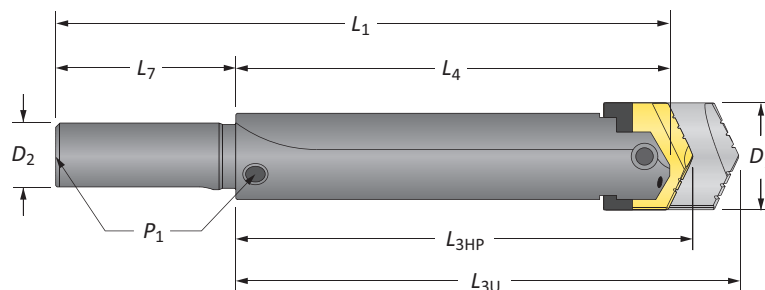

## Straight Shank

Length	$D_1$	Holder				Shank				Style	Part No.
		$L_{3HP}$	$L_{3U}$	$L_4$	$L_1$	$D_2$	$L_7$	$P_1$			
Short	3-1/2 - 4-1/2	6-25/32	7-7/16	6	11	2-1/2	5	1/2	#100	<b>20671-2500</b>	
Standard	3-1/2 - 4-1/2	13-25/32	14-7/16	13	18	2-1/2	5	1/2	#200	<b>20871-2500</b>	

**NOTE:** Adapter is required for D-H series High Performance spade drills. Adapters sold separately.

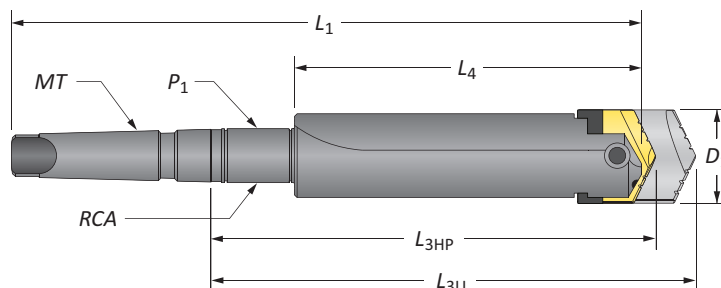

## Taper Shank

Length	$D_1$	Holder				Shank				Style	Part No.
		$L_{3HP}$	$L_{3U}$	$L_4$	$L_1$	$MT$	$P_1$	$RCA$			
Short	3-1/2 - 4-1/2	7-1/32	7-11/16	6	12-1/8	#5	-	-	#300	<b>21471-0005</b>	
Short	3-1/2 - 4-1/2	7-1/32	7-11/16	6	12-1/8	#5	-	-	#300 TSC	<b>21571-0005*</b>	
Short	3-1/2 - 4-1/2	9-11/32	10	6	14-7/16	#5	1/2	2T-6SR	#400 SR	<b>21671-0005</b>	
Standard	3-1/2 - 4-1/2	16-11/32	17	13	21-7/16	#5	1/2	2T-6SR	#500 SR	<b>21871-0005</b>	
Long	3-1/2 - 4-1/2	27-11/32	28	24	32-7/16	#5	1/2	2T-6SR	#600 SR	<b>22071-0005</b>	
XL	3-1/2 - 4-1/2	40-11/32	41	37	45-7/16	#5	1/2	2T-6SR	#700 SR	<b>22271-0005</b>	

\*Through shank coolant, coolant inlet diameter = 3/8"

**NOTE:** Adapter is required for D-H series High Performance spade drills. Adapters sold separately.

## Connection Accessories

<p><b>Clamping Screw</b> 3/4"-10 x 2-1/2"</p>	<p><b>Blade-Loc Screw</b> 5/16"-18 x 1/2"</p>
---	---

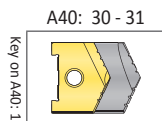

**i** = Imperial (in)  
**m** = Metric (mm)

**WARNING** Refer to Speed and Feed charts for recommended adjustments to speeds and feeds. Refer to page A40: 48 for deep hole drilling guidelines in this section of the catalog. Visit [www.alliedmachine.com/DeepHoleGuidelines](http://www.alliedmachine.com/DeepHoleGuidelines) for the most up-to-date information and procedures. Factory technical assistance is available for your specific applications through our Application Engineering Team.

## High Performance / Universal Spade Drill Insert Holders

### G Series

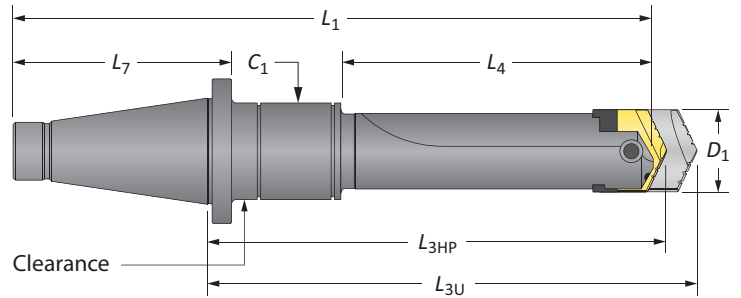

#### 50 NMTB Shank\*

Length	D <sub>1</sub>	Holder				Shank					Part No.
		L <sub>3HP</sub>	L <sub>3U</sub>	L <sub>4</sub>	L <sub>1</sub>	NMTB	L <sub>7</sub>	C <sub>1</sub>	RCA	Style	
Short	3-1/2 - 4-1/2	8-29/32	9-9/16	7	13-1/8	50	5-5/8	–	–	#300	<b>22471-0050</b>
Short	3-1/2 - 4-1/2	11-7/32	11-7/8	7	15-7/16	50	5-5/8	5/8	2T-65SR	#400	<b>22671-0050</b>
Short	3-1/2 - 4-1/2	19-13/32	20	15	23-7/16	50	5-5/8	5/8	2T-65SR	#500	<b>22881-0050</b>

\*All NMTB shank holders are discontinued items. Items listed are available (subject to prior sale) at list prices until stock is depleted. Once stock is depleted, items are available as quoted specials only.

#### Rotary Coolant Adapter (RCA) and Accessories

ID	OD	L <sub>1</sub>	Driving Rod Thread	P <sub>1</sub>	Part No.*	RCA O-Rings	
						Kit Part No.**	Replacements
2-1/4	3-3/4	1-3/4	1/2 - NC	1/2	<b>2T-6SR</b>	2T1-6SR	2T1-6OR-10
3-3/4	5-1/2	1-3/4	1/2 - NC	1/2	<b>2T-65SR</b>	2T1-65SR	2T1-65OR-10



\*RCA comes complete with (1) RCA, (2) O-rings, (2) snap rings, and (2) thrust washers

\*\*RCA Repair Kit includes (2) O-rings, (2) snap rings, and (2) thrust washers

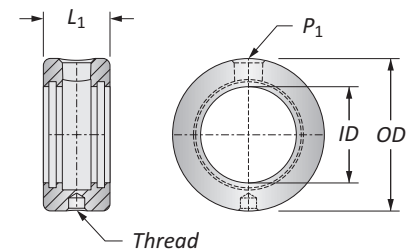
▲ Refer to page A40: 40 for proper RCA assembly and safety information



#### Connection Accessories

	
<b>Clamping Screw</b>	<b>Blade-Loc Screw</b>
3/4"-10 x 2-1/2"	5/16"-18 x 1/2"

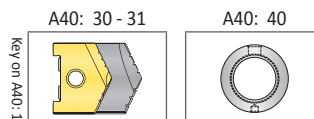

ⓘ = Imperial (in)  
 ⓘ = Metric (mm)  
 O-rings sold in packs of 10

**⚠ WARNING** RCA rotation during drilling can cause hose and/or hose fitting failure, machinery damage, and/or serious injury. To prevent, use RCA and positive stop studs when drilling. Factory technical assistance is also available for your specific applications.

## High Performance Spade Drill Inserts

H Series | Diameter Range: 4.0000" - 5.0000"

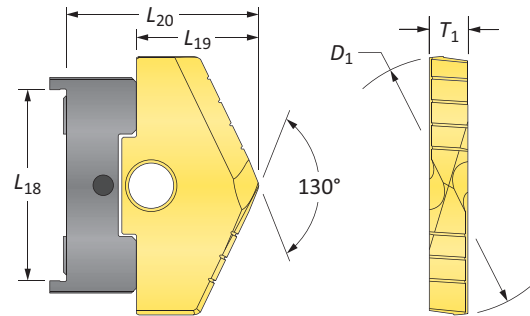
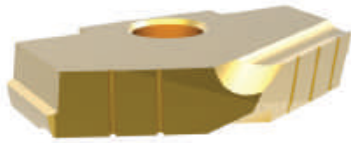

Series	D <sub>1</sub> inch		Insert				TiN Part No.	TiAlN Part No.	TiCN Part No.	Adapter
	Fraction	Decimal	L <sub>18</sub>	L <sub>19</sub>	L <sub>20</sub>	T <sub>1</sub>				
H <sup>1</sup>	4	4.0000	3-1/2	2-3/16	3-3/32	11/16	1028T-0400	1028A-0400	1028N-0400	1028U-Adapter
	4-1/16	4.0625	3-1/2	2-3/16	3-3/32	11/16	1028T-0402	1028A-0402	1028N-0402	1028U-Adapter
	4-1/8	4.1250	3-1/2	2-3/16	3-3/32	11/16	1028T-0404	1028A-0404	1028N-0404	1028U-Adapter
	4-3/16	4.1875	3-1/2	2-3/16	3-3/32	11/16	1028T-0406	1028A-0406	1028N-0406	1028U-Adapter
	4-1/4	4.2500	3-1/2	2-3/16	3-3/32	11/16	1028T-0408	1028A-0408	1028N-0408	1028U-Adapter
	4-5/16	4.3125	3-1/2	2-3/16	3-3/32	11/16	1028T-0410	1028A-0410	1028N-0410	1028U-Adapter
	4-3/8	4.3750	3-1/2	2-3/16	3-3/32	11/16	1028T-0412	1028A-0412	1028N-0412	1028U-Adapter
	4-7/16	4.4375	3-1/2	2-3/16	3-3/32	11/16	1028T-0414	1028A-0414	1028N-0414	1028U-Adapter
H <sup>2</sup>	4-1/2	4.5000	3-1/2	2-3/16	3-3/32	11/16	1028T-0416	1028A-0416	1028N-0416	1028U-Adapter
	4-9/16	4.5625	3-1/2	2-3/16	3-3/32	11/16	1028T-0418	1028A-0418	1028N-0418	1028U-Adapter
	4-5/8	4.6250	3-1/2	2-3/16	3-3/32	11/16	1028T-0420	1028A-0420	1028N-0420	1028U-Adapter
	4-11/16	4.6875	3-1/2	2-3/16	3-3/32	11/16	1028T-0422	1028A-0422	1028N-0422	1028U-Adapter
	4-3/4	4.7500	3-1/2	2-3/16	3-3/32	11/16	1028T-0424	1028A-0424	1028N-0424	1028U-Adapter
	4-13/16	4.8125	3-1/2	2-3/16	3-3/32	11/16	1028T-0426	1028A-0426	1028N-0426	1028U-Adapter
	4-7/8	4.8750	3-1/2	2-3/16	3-3/32	11/16	1028T-0428	1028A-0428	1028N-0428	1028U-Adapter
	4-15/16	4.9375	3-1/2	2-3/16	3-3/32	11/16	1028T-0430	1028A-0430	1028N-0430	1028U-Adapter
5	5.0000	3-1/2	2-3/16	3-3/32	11/16	1028T-0500	1028A-0500	1028N-0500	1028U-Adapter	

**NOTE:** Adapter is required for D-H series High Performance spade drills. Adapters sold separately.

Inserts sold in multiples of 1

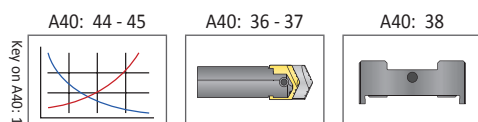

Sizes not shown are available upon request.

When ordering, please follow the example below:

<b>Inch:</b>	7-63/64", 130° CPM-M4 (H8 series) = use Part No. <b>10294-7.9843</b>
<b>Decimal:</b>	6.391", 130° CPM-M4 (H5 series) = use Part No. <b>10294-6.3910</b>



### Universal Spade Drill Inserts

H<sup>1</sup> - H<sup>2</sup> Series | Diameter Range: 4.0000" - 8.5000"

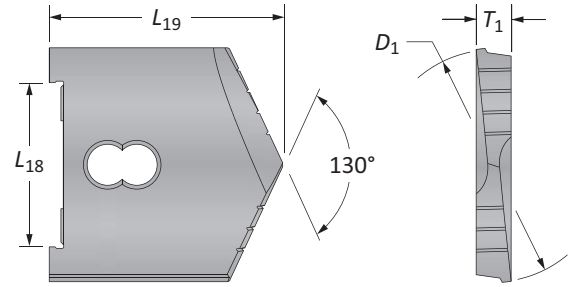

Series	D <sub>1</sub> inch		Insert					
	Fraction	Decimal	L <sub>18</sub>	L <sub>19</sub>	T <sub>1</sub>	130° CPM-M4	130° CPM-T15*	Flat Bottom
H <sup>1</sup>	4	4.0000	3-1/2	3-11/16	11/16	10284-0400	10285-0400	10484-0400
	4-1/16	4.0625	3-1/2	3-11/16	11/16	10284-0402	-	-
	4-1/8	4.1250	3-1/2	3-11/16	11/16	10284-0404	10285-0404	10484-0404
	4-3/16	4.1875	3-1/2	3-11/16	11/16	10284-0406	-	-
	4-1/4	4.2500	3-1/2	3-11/16	11/16	10284-0408	-	10484-0408
	4-5/16	4.3125	3-1/2	3-11/16	11/16	10284-0410	-	-
	4-3/8	4.3750	3-1/2	3-11/16	11/16	10284-0412	-	10484-0412
	4-7/16	4.4375	3-1/2	3-11/16	11/16	10284-0414	-	-
H <sup>2</sup>	4-1/2	4.5000	3-1/2	3-11/16	11/16	10284-0416	10285-0416	10484-0416
	4-9/16	4.5625	3-1/2	3-11/16	11/16	10284-0418	-	-
	4-5/8	4.6250	3-1/2	3-11/16	11/16	10284-0420	-	10484-0420
	4-11/16	4.6875	3-1/2	3-11/16	11/16	10284-0422	-	-
	4-3/4	4.7500	3-1/2	3-11/16	11/16	10284-0424	-	10484-0424
	4-13/16	4.8125	3-1/2	3-11/16	11/16	10284-0426	-	-
	4-7/8	4.8750	3-1/2	3-11/16	11/16	10284-0428	-	10484-0428
	4-15/16	4.9375	3-1/2	3-11/16	11/16	10284-0430	-	-
	5	5.0000	3-1/2	3-11/16	11/16	10284-0500	10285-0500	10484-0500

\*Discontinued

Inserts sold in multiples of 1

NOTE: POR = Priced on request

Flat Bottom

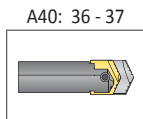
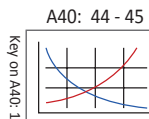
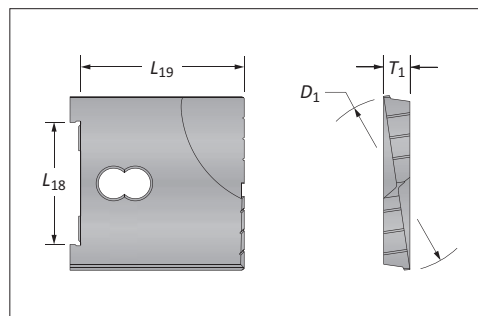

Sizes not shown are available upon request.  
When ordering, please follow the example below:

Inch:	1-17/64", 130° CPM-M4 (B series) = use Part No. 10224-1.2656
Decimal:	1.5110", 130° Flat Bottom (C series) = use Part No. 10434-1.5110

## Universal Spade Drill Inserts

H<sup>3</sup> - H<sup>9</sup> Series | Diameter Range: 5.1250" - 8.5000"

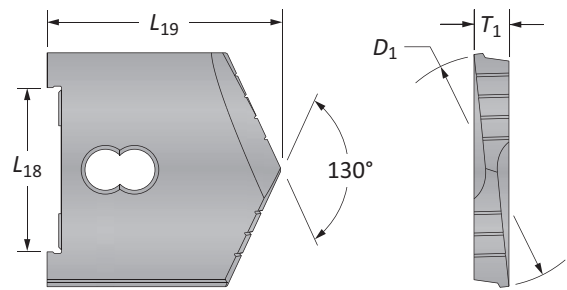

Series	D <sub>1</sub> inch		Insert			 130° CPM-M4
	Fraction	Decimal	L <sub>18</sub>	L <sub>19</sub>	T <sub>1</sub>	
H <sup>3</sup>	5-1/8	5.1250	3-1/2	3-11/16	11/16	10294-0504
	5-1/4	5.2500	3-1/2	3-11/16	11/16	10294-0508
	5-3/8	5.3750	3-1/2	3-11/16	11/16	10294-0512
	5-1/2	5.5000	3-1/2	3-11/16	11/16	10294-0516
H <sup>4</sup>	5-5/8	5.6250	3-1/2	3-11/16	11/16	10294-0520
	5-3/4	5.7500	3-1/2	3-11/16	11/16	10294-0524
	5-7/8	5.8750	3-1/2	3-11/16	11/16	10294-0528
	6	6.0000	3-1/2	3-11/16	11/16	10294-0600
H <sup>5</sup>	6-1/8	6.1250	3-1/2	3-11/16	11/16	10294-0604
	6-1/4	6.2500	3-1/2	3-11/16	11/16	10294-0608
	6-3/8	6.3750	3-1/2	3-11/16	11/16	10294-0612
	6-1/2	6.5000	3-1/2	3-11/16	11/16	10294-0616
H <sup>6</sup>	6-5/8	6.6250	3-1/2	3-11/16	11/16	10294-0620
	6-3/4	6.7500	3-1/2	3-11/16	11/16	10294-0624
	6-7/8	6.8750	3-1/2	3-11/16	11/16	10294-0628
	7	7.0000	3-1/2	3-11/16	11/16	10294-0700
H <sup>7</sup>	7-1/8	7.1250	3-1/2	3-11/16	11/16	10294-0704
	7-1/4	7.2500	3-1/2	3-11/16	11/16	10294-0708
	7-3/8	7.3750	3-1/2	3-11/16	11/16	10294-0712
	7-1/2	7.5000	3-1/2	3-11/16	11/16	10294-0716
H <sup>8</sup>	7-5/8	7.6250	3-1/2	3-11/16	11/16	10294-0720
	7-3/4	7.7500	3-1/2	3-11/16	11/16	10294-0724
	7-7/8	7.8750	3-1/2	3-11/16	11/16	10294-0728
	8	8.0000	3-1/2	3-11/16	11/16	10294-0800
H <sup>9</sup>	8-1/8	8.1250	3-1/2	3-11/16	11/16	10294-0804
	8-1/4	8.2500	3-1/2	3-11/16	11/16	10294-0808
	8-3/8	8.3750	3-1/2	3-11/16	11/16	10294-0812
	8-1/2	8.5000	3-1/2	3-11/16	11/16	10294-0816

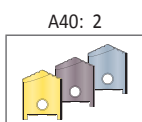
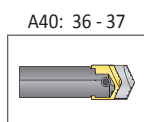
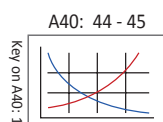

Sizes not shown are available upon request.  
When ordering, please follow the example below:

<b>Inch:</b>	1-17/64", 130° CPM-M4 (B series) = use Part No. <b>10224-1.2656</b>
<b>Decimal:</b>	1.5110", 130° Flat Bottom (C series) = use Part No. <b>10434-1.5110</b>

## High Performance / Universal Spade Drill Insert Holders

### H Series

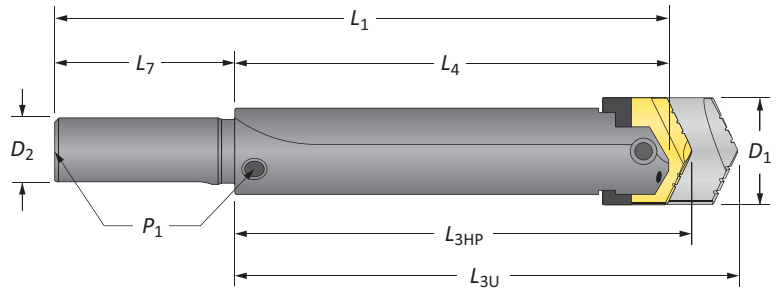

#### Straight Shank

Length	D <sub>1</sub>	Holder				Shank				Style	Part No.
		L <sub>3HP</sub>	L <sub>3U</sub>	L <sub>4</sub>	L <sub>1</sub>	D <sub>2</sub>	L <sub>7</sub>	P <sub>1</sub>			
Short	4 - 8-1/2	7-31/32	8-9/16	7	13	2-1/2	6	1/2	#100	20681-2500	
Standard	4 - 8-1/2	15-31/32	16-9/16	15	21	2-1/2	6	1/2	#200	20881-2500	

**NOTE:** Adapter is required for D-H series High Performance spade drills. Adapters sold separately.

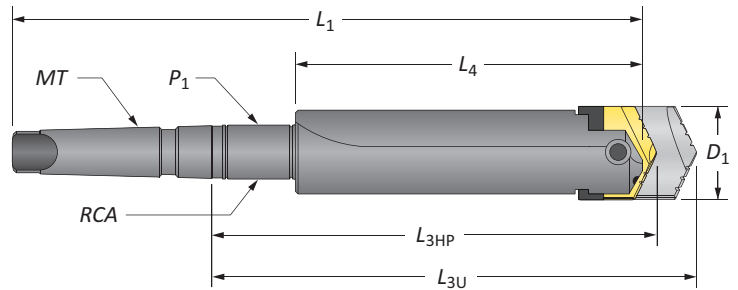

#### Taper Shank

Length	D <sub>1</sub>	Holder				Shank				Style	Part No.
		L <sub>3HP</sub>	L <sub>3U</sub>	L <sub>4</sub>	L <sub>1</sub>	MT	P <sub>1</sub>	RCA			
Short	4 - 8-1/2	8-7/32	8-13/16	7	13-1/8	#5	-	-	#300	21481-0005	
Short	4 - 8-1/2	10-17/32	11-1/8	7	15-7/16	#5	1/2	2T-6SR	#400 SR	21681-0005	
Standard	4 - 8-1/2	18-17/32	19-1/8	15	23-7/16	#5	1/2	2T-6SR	#500 SR	21881-0005	
Standard	4 - 8-1/2	18-17/32	19-1/8	15	25-7/8	#6	1/2	2T-55SR	#500 SR	21881-0006	
Long	4 - 8-1/2	27-19/32	28-3/16	24	34-7/8	#6	1/2	2T-55SR	#600 SR	22081-0006	
XL	4 - 8-1/2	43-19/32	44-3/16	40	50-7/8	#6	1/2	2T-55SR	#700 SR	22281-0006	

**NOTE:** Adapter is required for D-H series High Performance spade drills. Adapters sold separately.

#### Rotary Coolant Adapter (RCA) and Accessories

ID	OD	L <sub>1</sub>	Driving Rod Thread	P <sub>1</sub>	Part No.*	RCA O-Rings	
						Kit Part No.**	Replacements
2-1/4	3-3/4	1-3/4	1/2 - NC	1/2	2T-6SR	2T1-6SR	2T1-6OR-10
2-1/2	4	1-3/4	1/2 - NC	1/2	2T-55SR	2T1-55SR	2T1-55OR-10



\*RCA comes complete with (1) RCA, (2) O-rings, (2) snap rings, and (2) thrust washers

\*\*RCA Repair Kit includes (2) O-rings, (2) snap rings, and (2) thrust washers

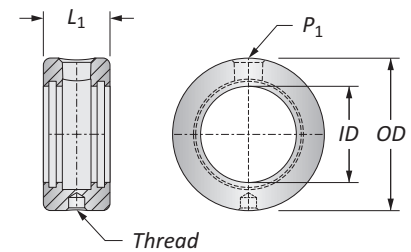
▲ Refer to page A40: 40 for proper RCA assembly and safety information



#### Connection Accessories

	
<b>Clamping Screw</b>	<b>Blade-Loc Screw</b>
3/4"-10 x 2-1/2"	3/8"-16 x 3/4"

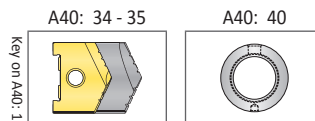

ⓘ = Imperial (in)  
Ⓜ = Metric (mm)  
O-rings sold in packs of 10

**WARNING** Refer to Speed and Feed charts for recommended adjustments to speeds and feeds. Refer to page A40: 48 for deep hole drilling guidelines in this section of the catalog. Visit [www.alliedmachine.com/DeepHoleGuidelines](http://www.alliedmachine.com/DeepHoleGuidelines) for the most up-to-date information and procedures. Factory technical assistance is available for your specific applications through our Application Engineering Team.



## High Performance Spade Drill Insert Adapters

D - H Series

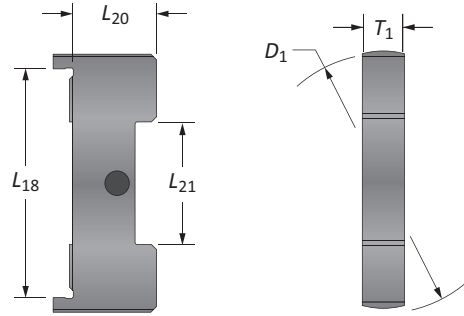

Series	D <sub>1</sub>	Adapter				Part No.
		L <sub>18</sub>	L <sub>20</sub>	L <sub>21</sub>	T <sub>1</sub>	
D	1.995	1-3/4	43/64	15/16	3/8	1024U-Adapter
E	2.495	2-1/16	21/32	1-3/16	7/16	1025U-Adapter
F	2.995	2-5/8	23/32	1-1/4	1/2	1026U-Adapter
G	3.495	3-1/16	25/32	1-13/16	5/8	1027U-Adapter
H	3.995	3-1/2	29/32	2-1/4	11/16	1028U-Adapter



**Step 1:**  
Position the adapter into the holder.

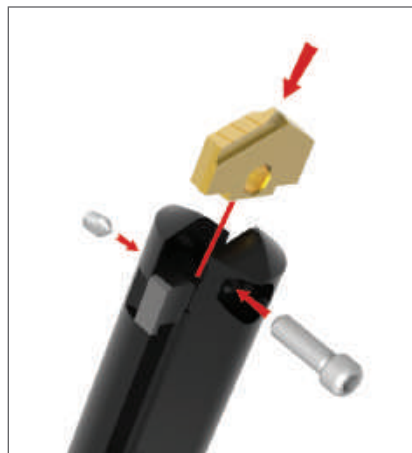

**Step 2:**  
Slide the insert into the adapter inside the holder.



**Step 3:**  
Insert and tighten both the clamping screw and Blade-Loc screw to secure the insert and adapter into position.

### Adapter Interchangeability

- Adapters allow the use of complete spade drill insert range
- Needed for D - H series (not required for A - C series)
- Adapter + High Performance insert combination can be interchanged with Universal insert and/or other holders
- Manufactured to ANSI B94.49-1975 TYPE I specifications



## Blade-Loc Drill Insert Holders

D - H Series

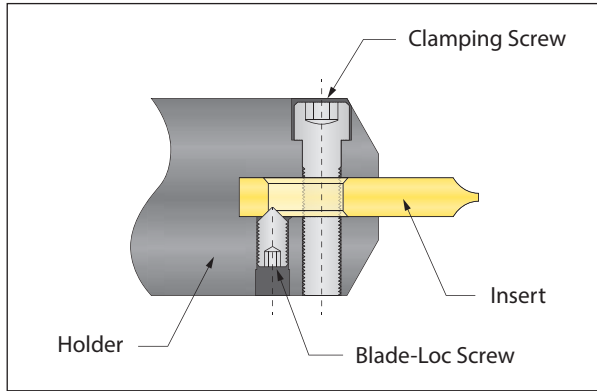

**Universal Spade Drill Insert**

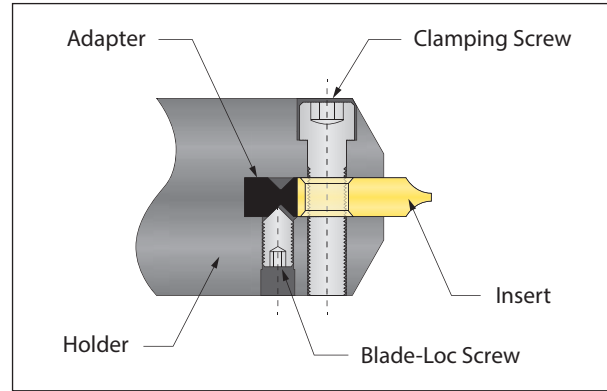



**High Performance Spade Drill Insert**

### Blade-Loc Drill Holders - Universal

- Helps align the spade drill while locking it in place
- Protects against tool movement during the drilling cycle and when the tool is being retracted from the hole
- Standard feature in D - H series holders

### Blade-Loc Drill Holders - High Performance

- Secures the adapter to the holder
- Allows inserts to be exchanged without any need to remove, clean, and re-insert the adapter

Series	 Clamping Screw	 Blade-Loc Screw
A	#10-24 x 5/8	-
B	1/4"-20 x 7/8	-
C	1/4"-20 x 1	-
D	3/8"-16 x 1-1/4"	5/16"-18 x 1/2"
E	1/2"-13 x 1-3/4"	5/16"-18 x 1/2"
F	5/8"-10 x 2	5/16"-18 x 1/2"
G	3/4"-10 x 2-1/2	5/16"-18 x 1/2"
H	3/4"-10 x 2-1/2	3/8"-16 x 3/4"

## Rotary Coolant Adapters (RCA)

### Morse Taper Shanks

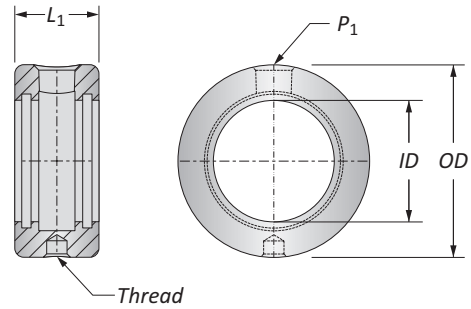

Holder Series	ID	OD	L <sub>1</sub>	Driving Rod Thread	P <sub>1</sub>	Part No.*	Max Recommended RPM	RCA O-Rings	
								Kit Part No.**	Replacements
A, B, C, D	1-1/4	2-1/2	1-3/8	3/8 - NC	1/4	⚠ 2T-4SR	2000	2T1-4SR	2T1-4OR-10
B, C, D	1-3/4	3	1-3/8	3/8 - NC	1/4	⚠ 2T-5SR	1500	2T1-5SR	2T1-5OR-10
E, F, G, H	2-1/4	3-3/4	1-3/4	1/2 - NC	1/2	⚠ 2T-6SR	1100	2T1-6SR	2T1-6OR-10
D, E, H	2-1/2	4	1-3/4	1/2 - NC	1/2	⚠ 2T-55SR	1100	2T1-55SR	2T1-55OR-10
F	3	4-1/2	1-3/4	1/2 - NC	1/2	⚠ 2T-60SR	900	2T1-60SR	2T1-60OR-10
G	3-3/4	5-1/2	1-3/4	1/2 - NC	1/2	⚠ 2T-65SR	700	2T1-65SR	2T1-65OR-10

\*RCA comes complete with (1) RCA, (2) O-rings, (2) snap rings, and (2) thrust washers

\*\*RCA Repair Kit includes (2) O-rings, (2) snap rings, and (2) thrust washers

**NOTE:** Max recommended pressure is 600 PSI (42 bar)

**NOTE:** Recommendations above are based on water and oil based coolants

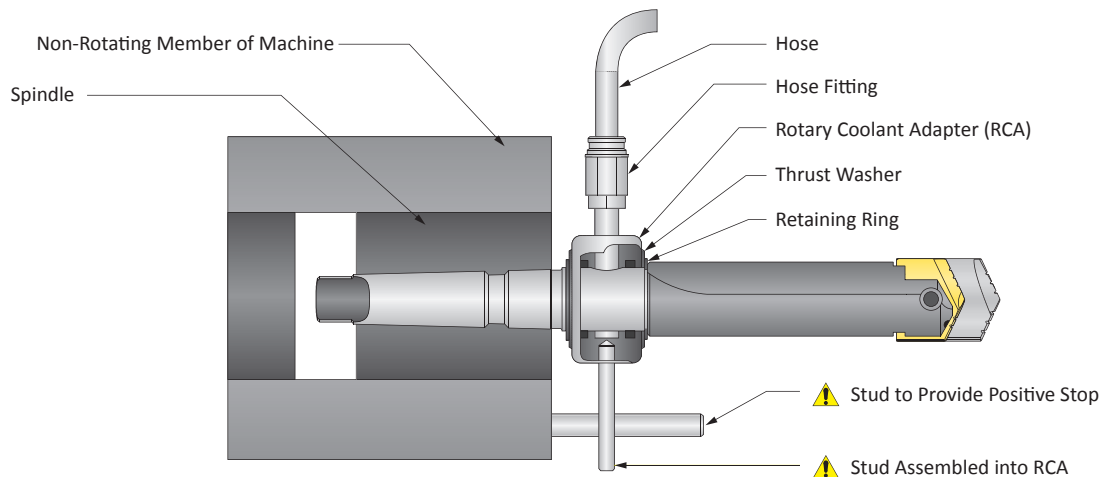

ⓘ = Imperial (in)

Ⓜ = Metric (mm)

O-rings sold in packs of 10

**⚠ WARNING** RCA rotation during drilling can cause hose and/or hose fitting failure, machinery damage, and/or serious injury. To prevent, use RCA and positive stop studs when drilling. Factory technical assistance is also available for your specific applications.

**Accessories**



**Top Mounting Plate**

Part No.	Description
25000-2505	Top mounting plate only. It is available for those who already have a Universal grinding fixture or may wish to adapt it to some other device. The plate comes complete with all the hardware required to locate and clamp any series Universal style spade drill to the plate.

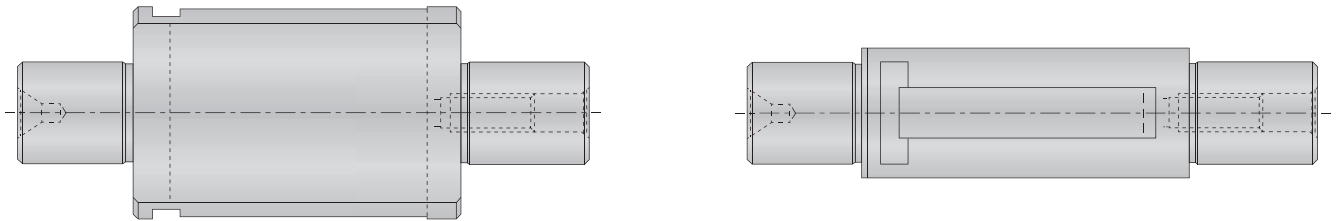

**Cylindrical Grinding Fixture**

Series	Diameter Range	Part No.
A	15/16 - 1-3/8	24410-2560
B	1-1/4 - 1-3/4	24420-2565
C	1-1/2 - 2-3/8	24430-2570
D	2 - 2-7/8	24440-2575
E	2-1/2 - 3-3/8	24450-2580
F	3 - 3-7/8	24460-2585
G	3-1/2 - 4-1/2	24470-2590
H*	4 - 8-1/2	24480-2595

Items included with the Cylindrical Grinding Fixture: (1) set screw, (1) slip pin

\*Applies to drills with a reference length of 3-11/16". Cylindrical Grinding Fixtures for drills with a 4-11/16" reference length will be quoted upon request

A  
DRILLING  
B  
BORING  
C  
REAMING  
D  
BURNISHING  
E  
THREADING  
X  
SPECIALS

## Regrind Charts

### Universal Inserts

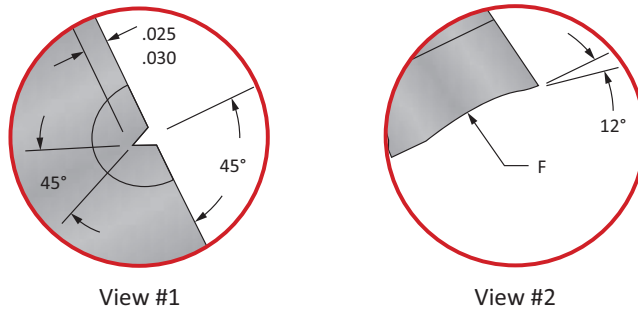
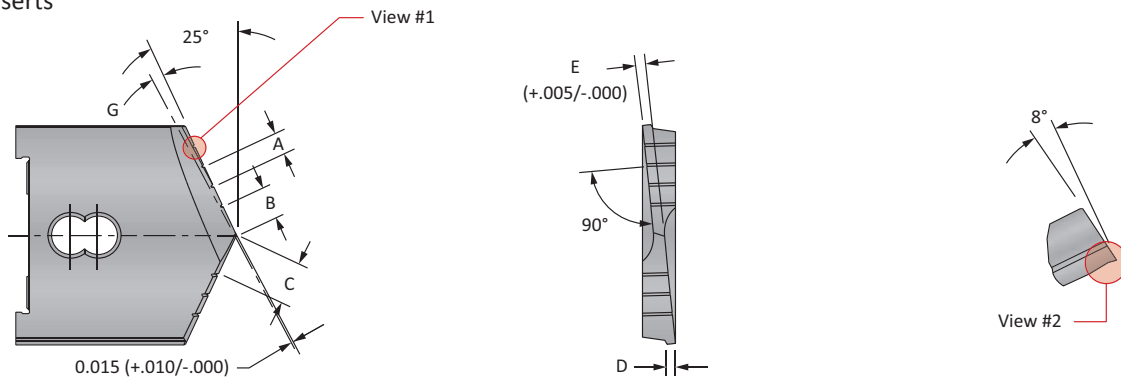

### Universal (130°) Spade Drill Inserts

Series	Insert Thickness	Size Range	A	B	C	D	E	F	G
AA	1/4	1 - 1-3/8	0.125	0.156	0.218	0.065	0.070	1/4	3°
A	3/16	31/32 - 1-3/8	0.125	0.156	0.218	0.065	0.065	1/4	3°
B	9/32	1-1/4 - 1-3/4	0.150	0.250	0.325	0.070	0.090	5/16	3°
C	5/16	1-1/2 - 2-3/8	0.200	0.250	0.350	0.080	0.100	5/16	3°
D	3/8	2 - 2-7/8	0.250	0.375	0.500	0.100	0.120	3/8	3°
E	7/16	2-1/2 - 3-3/8	0.300	0.437	0.587	0.100	0.140	3/8	3°
F	1/2	3 - 3-7/8	0.350	0.437	0.612	0.125	0.170	3/8	3°
G	5/8	3-1/2 - 4-1/2	0.350	0.500	0.675	0.140	0.200	3/8	3°
H <sup>1</sup> - H <sup>2</sup>	11/16	4 - 5	0.400	0.500	0.700	0.165	0.225	1/2	3°
H <sup>3</sup>	11/16	5-1/8 - 5-1/2	0.500	0.500	0.750	0.185	0.250	1/2	3°
H <sup>4</sup> - H <sup>9</sup>	11/16	5-5/8 - 8-1/2	0.500	0.500	0.750	0.185	0.250	1/2	2°

**NOTE:** Maintain cutting edges of the tool within 0.001" T.I.R.

**High Performance Regrinds:** High Performance inserts should be reground and coated by Allied Machine before returning them to production. The real economy of High Performance spade inserts is their improved production rates (100% and 500%) and increased tool life (3 to 20 times). Factory regrounding and coating provides like-new tool performance. Our factory service reduces your total cost-per-hole.

## Regrind Charts

### Universal Inserts

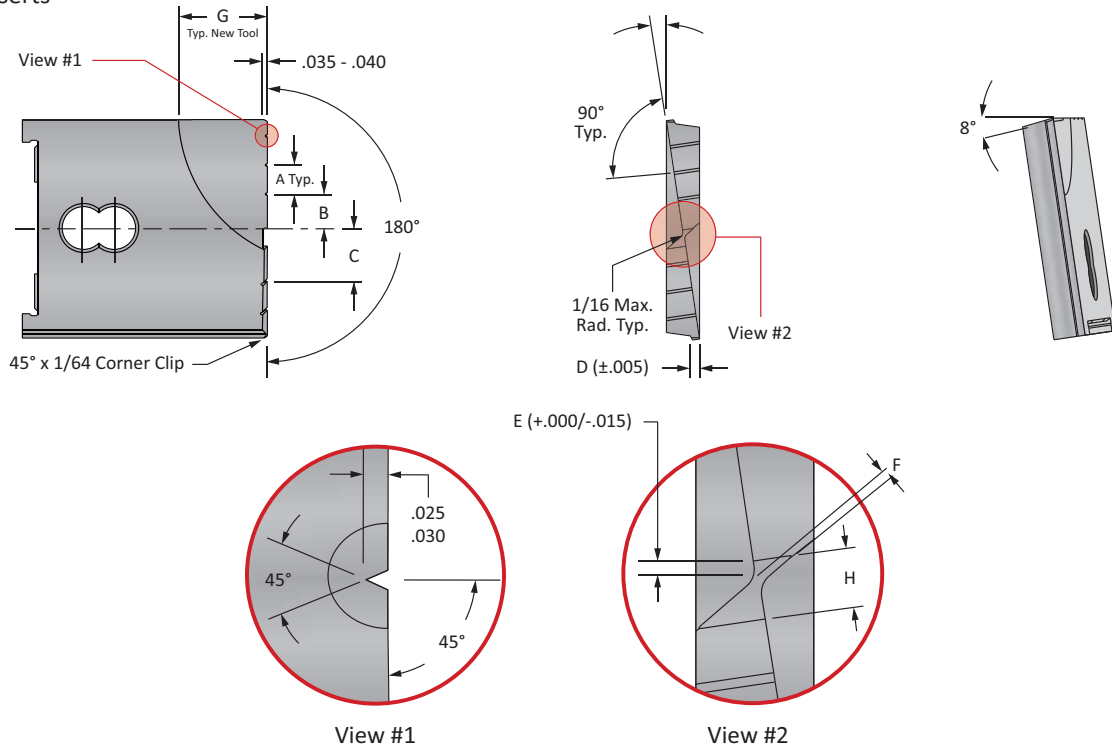

### Flat Bottom Spade Drill Inserts



Series	Insert Thickness	Size Range	A	B	C	D	E	F	G	H
AA	1/4	1 - 1-3/8	0.150	0.250	0.325	0.065	1/64 - 1/32	0.075	7/16	1/8
A	3/16	31/32 - 1-3/8	0.150	0.250	0.325	0.065	1/64 - 1/32	0.075	7/16	1/8
B	9/32	1-1/4 - 1-3/4	0.200	0.250	0.350	0.070	1/64 - 1/32	0.075	1/2	1/8
C	5/16	1-1/2 - 2-3/8	0.200	0.250	0.350	0.080	1/32 - 3/64	0.075	5/8	1/8
D	3/8	2 - 2-7/8	0.300	0.375	0.525	0.100	1/32 - 3/64	0.129	7/8	3/16
E	7/16	2-1/2 - 3-3/8	0.300	0.375	0.525	0.100	1/32 - 1/16	0.129	1-1/8	3/16
F	1/2	3 - 3-7/8	0.300	0.500	0.650	0.125	1/32 - 1/16	0.156	1-1/4	1/4
G	5/8	3-1/2 - 4-1/2	0.400	0.500	0.700	0.140	1/32 - 1/16	0.156	1-1/2	1/4
H <sup>1</sup> - H <sup>2</sup>	11/16	4 - 5	0.500	0.500	0.750	0.165	1/32 - 1/16	0.156	1-1/2	1/4

**NOTE:** Grind cutting edge 0.005" above center line at the center of the new tool

**NOTE:** Maintain flatness and height across the cutting edges of the tool within 0.001" T.I.R.

## Recommended Cutting Data | Imperial (inch)

### High Performance Spade Inserts

ISO	Material	Hardness (BHN)	 TiN SFM	 TiAlN SFM	 TiCN SFM	Feed Rate (IPR) by Diameter			
						1 - 1-1/4	1-1/4 - 2	2 - 3	3 - 5
P	Free Machining Steel 1118, 1215, 12L14, etc.	100 - 150	200	280	260	.016	.020	.023	0.28
		150 - 200	180	260	235	.016	.020	.023	.028
		200 - 250	160	240	210	.016	.020	.023	.028
P	Low Carbon Steel 1010, 1020, 1025, 1522, 1144, etc.	85 - 125	170	250	220	.015	.019	.023	.027
		125 - 175	160	240	210	.015	.019	.023	.027
		175 - 225	150	225	195	.014	.018	.021	.024
		225 - 275	140	210	180	.014	.018	.021	.024
P	Medium Carbon Steel 1030, 1040, 1050, 1527, 1140, 1151, etc.	125 - 175	160	240	210	.015	.019	.023	.027
		175 - 225	150	225	195	.014	.018	.021	.024
		225 - 275	140	210	180	.014	.018	.021	.024
		275 - 325	130	195	170	.012	.016	.019	.022
P	Alloy Steel 4140, 5140, 8640, etc.	125 - 175	150	210	195	.014	.017	.019	.022
		175 - 225	140	195	180	.014	.017	.019	.022
		225 - 275	130	180	170	.014	.017	.019	.022
		275 - 325	120	170	155	.012	.015	.017	.020
		325 - 375	110	155	145	.012	.015	.017	.020
P	High Strength Alloy 4340, 4330V, 300M, etc.	225 - 300	80	110	100	.010	.014	.017	.020
		300 - 350	60	85	80	.010	.014	.017	.020
		350 - 400	50	70	65	.009	.012	.015	.018
P	Structural Steel A36, A285, A516, etc.	100 - 150	140	200	180	.014	.018	.021	.026
		150 - 250	120	170	155	.012	.016	.019	.024
		250 - 350	100	140	130	.010	.014	.017	.020
P	Tool Steel H-13, H-21, A-4, O-2, S-3, etc.	150 - 200	80	110	105	.010	.012	.015	.017
		200 - 250	60	90	85	.010	.012	.015	.017
S	High Temp Alloy Hastelloy B, Inconel 600, etc.	140 - 220	30	40	35	.010	.012	.015	-
		220 - 310	25	35	30	.008	.010	.012	-
M	Stainless Steel 303, 416, 420, 17-4 PH, etc.	135 - 185	75	105	95	.011	.014	.016	.020
		185 - 275	60	90	80	.010	.012	.014	.018
K	Cast Iron	120 - 150	170	250	220	.020	.024	.027	.030
		150 - 200	150	225	195	.018	.022	.025	.028
		200 - 220	130	195	170	.016	.018	.021	.024
		220 - 260	110	165	145	.012	.014	.017	.020
		260 - 320	90	135	120	.009	.012	.014	.016
N	Aluminum	30	600	850	750	.020	.022	.025	.025
		180	300	450	400	.018	.022	.025	.025

#### Deep Hole Drilling Speed and Feed Adjustment

	Holder Length	
	Long	XL
Speed	0.90	0.80
Feed	-	0.90

#### Recommended Speed and Feed Example

If the recommended speed and feed is 200 SFM and 0.016 IPR for a standard length holder, then the speed and feed using an XL holder in the same application would be 160 SFM and 0.014 IPR.

$200 \cdot 0.80 = 160 \text{ SFM}$	$0.016 \cdot 0.90 = 0.014 \text{ IPR}$
------------------------------------	--

#### **⚠ WARNING** Tool failure can cause serious injury. To prevent:

- When using holders without support bushing, use a short length holder to establish an initial hole that is a minimum of 2 diameters deep.
- Do not rotate tool holders more than 50 RPM unless it is engaged with the workpiece or fixture.

Refer to page A40: 48 for Deep Hole Drilling Guidelines. Visit [www.alliedmachine.com/DeepHoleGuidelines](http://www.alliedmachine.com/DeepHoleGuidelines) for the most up-to-date information and procedures. Factory technical assistance is available for your specific applications through our Application Engineering Team.

**IMPORTANT:** The speeds and feeds listed above are a general starting point for all applications. Refer to the Coolant Recommendation chart for coolant requirements to run at the recommended speeds and feeds. Factory technical assistance is available through our Application Engineering department. See adjustment examples on the following page.

## Coolant Recommendations | Imperial (inch)

### High Performance Spade Inserts

ISO	Material	Data Metrics	Data by Diameter			
			1 - 1-1/4	1-1/4 - 2	2 - 3	3 - 5
P	Free Machining Steel 1118, 1215, 12L14, etc.	Hardness (BHN)	100 - 250	100 - 250	100 - 250	100 - 250
		Coolant Pressure (PSI)	105 - 150	55 - 75	45 - 60	35 - 45
		Coolant Volumetric Flow Rate (GPM)	6.3 - 7.6	15 - 18	31 - 36	47 - 53
	Low Carbon Steel	Hardness (BHN)	85 - 275	85 - 275	85 - 275	85 - 275
		Coolant Pressure (PSI)	80 - 115	45 - 55	35 - 45	30 - 35
		Coolant Volumetric Flow Rate (GPM)	5.5 - 6.6	14 - 15	28 - 31	43 - 46
	Medium Carbon Steel	Hardness (BHN)	125 - 325	125 - 325	125 - 325	125 - 325
		Coolant Pressure (PSI)	70 - 100	40 - 50	35 - 40	30 - 35
		Coolant Volumetric Flow Rate (GPM)	5.2 - 6.2	13 - 15	28 - 30	43 - 46
	Alloy Steel	Hardness (BHN)	125 - 375	125 - 375	125 - 375	125 - 375
		Coolant Pressure (PSI)	60 - 85	30 - 40	30 - 35	25 - 30
		Coolant Volumetric Flow Rate (GPM)	4.8 - 5.7	11 - 13	26 - 28	39 - 43
	High Strength Alloy 4340, 4330V, 300M, etc.	Hardness (BHN)	225 - 400	225 - 400	225 - 400	225 - 400
		Coolant Pressure (PSI)	25 - 30	20 - 25	20 - 25	20 - 25
		Coolant Volumetric Flow Rate (GPM)	3.1 - 3.4	9 - 10	21 - 23	35 - 39
	Structural Steel A36, A285, A516, etc.	Hardness (BHN)	100 - 350	100 - 350	100 - 350	100 - 350
		Coolant Pressure (PSI)	50 - 70	30 - 35	25 - 30	25 - 30
		Coolant Volumetric Flow Rate (GPM)	4.4 - 5.2	11 - 12	23 - 26	39 - 43
Tool Steel H-13, H-21, A-4, O-2, S-3, etc.	Hardness (BHN)	150 - 250	150 - 250	150 - 250	150 - 250	
	Coolant Pressure (PSI)	25 - 30	20 - 25	20 - 25	20 - 25	
	Coolant Volumetric Flow Rate (GPM)	3.1 - 3.4	9 - 10	21 - 23	35 - 43	
S	High Temp Alloy Hastelloy B, Inconel 600, etc.	Hardness (BHN)	140 - 310	140 - 310	140 - 310	140 - 310
		Coolant Pressure (PSI)	35 - 40	25 - 30	25 - 30	-
		Coolant Volumetric Flow Rate (GPM)	3.6 - 3.9	10 - 11	23 - 26	-
M	Stainless Steel 303, 416, 420, 17-4 PH, etc.	Hardness (BHN)	135 - 275	135 - 275	135 - 275	135 - 275
		Coolant Pressure (PSI)	50 - 65	30 - 35	25 - 30	25 - 30
		Coolant Volumetric Flow Rate (GPM)	4.4 - 5.0	11 - 12	23 - 26	39 - 43
K	Cast Iron	Hardness (BHN)	120 - 320	120 - 320	120 - 320	120 - 320
		Coolant Pressure (PSI)	40 - 50	25 - 30	25 - 30	20 - 25
		Coolant Volumetric Flow Rate (GPM)	3.9 - 4.4	10 - 11	23 - 26	35 - 43
N	Aluminum	Hardness (BHN)	30 - 180	30 - 180	30 - 180	30 - 180
		Coolant Pressure (PSI)	150 - 220	80 - 115	60 - 80	55 - 70
		Coolant Volumetric Flow Rate (GPM)	7.6 - 9.1	19 - 22	36 - 42	59 - 66

#### Deep Hole Drilling Speed and Feed Adjustment

Pressure and Flow	Holder Length	
	Long	XL
	1.3	2

#### Recommended Speed and Feed Example

If the recommended pressure and flow is 150 PSI and 6.3 GPM for a standard length holder, then the adjusted pressure and flow using an XL holder in the same application would be 300 PSI and 12.6 GPM.

$150 \bullet 2 = 300 \text{ PSI}$	$6.3 \bullet 2 = 12.6 \text{ GPM}$
-----------------------------------	------------------------------------

**⚠ WARNING** Tool failure can cause serious injury. To prevent:

- When using holders without support bushing, use a short length holder to establish an initial hole that is a minimum of 2 diameters deep.
- Do not rotate tool holders more than 50 RPM unless it is engaged with the workpiece or fixture.

Refer to page A40: 48 for Deep Hole Drilling Guidelines. Visit [www.alliedmachine.com/DeepHoleGuidelines](http://www.alliedmachine.com/DeepHoleGuidelines) for the most up-to-date information and procedures. Factory technical assistance is available for your specific applications through our Application Engineering Team.

**IMPORTANT:** The coolant pressure and flow rate recommendation below represents a good approximation to obtain optimum tool life and chip evacuation at the recommended speeds and feeds. If lower coolant capabilities exist in a drilling application, the HP/Universal drilling system will still function at reduced penetration rates. Contact our Application Engineering department for more specific recommendations of coolant requirements and/or speeds and feeds.

A  
DRILLING  
B  
BORING  
C  
REAMING  
D  
BURNISHING  
E  
THREADING  
X  
SPECIALS

## Recommended Cutting Data | Imperial (inch)

### Universal Spade Inserts

ISO	Material	Hardness (BHN)	SFM	Feed Rate (IPR) by Diameter			
				1 - 1-1/4	1-1/4 - 2	2 - 3	3 - 5
P	Free Machining Steel 1118, 1215, 12L14, etc.	100 - 150	100	.014	.016	.020	.024
		150 - 200	90	.013	.015	.019	.022
		200 - 250	80	.012	.014	.018	.020
	Low Carbon Steel 1010, 1020, 1025, 1522, 1144, etc.	85 - 125	80	.012	.015	.018	.020
		125 - 175	75	.012	.014	.017	.020
		175 - 225	60	.010	.014	.016	.018
		225 - 275	55	.010	.013	.016	.018
	Medium Carbon Steel 1030, 1040, 1050, 1527, 1140, 1151, etc.	125 - 175	65	.010	.014	.018	.020
		175 - 225	60	.010	.014	.016	.020
		225 - 275	50	.008	.013	.016	.018
		275 - 325	45	.008	.012	.014	.016
	Alloy Steel 4140, 5140, 8640, etc.	125 - 175	60	.010	.014	.018	.020
175 - 225		55	.010	.014	.016	.020	
225 - 275		45	.008	.013	.016	.018	
275 - 325		35	.008	.012	.014	.016	
High Strength Alloy 4340, 4330V, 300M, etc.	225 - 300	40	.008	.012	.014	.016	
	300 - 350	30	.006	.010	.014	.016	
	350 - 400	25	.006	.008	.014	.016	
Structural Steel A36, A285, A516, etc.	100 - 150	70	.012	.016	.018	.020	
	150 - 250	60	.010	.014	.016	.018	
	250 - 350	50	.008	.012	.014	.016	
Tool Steel H-13, H-21, A-4, O-2, S-3, etc.	150 - 200	50	.009	.011	.014	.016	
	200 - 250	40	.008	.010	.013	.015	
S	High Temp Alloy Hastelloy B, Inconel 600, etc.	140 - 220	20	.008	.010	.012	-
		220 - 310	15	.007	.009	.011	-
M	Stainless Steel 303, 416, 420, 17-4 PH, etc.	135 - 185	45	.008	.012	.015	.018
		185 - 275	35	.007	.010	.013	.016
K	Cast Iron	120 - 150	100	.016	.020	.022	.025
		150 - 200	80	.015	.018	.020	.022
		200 - 220	70	.011	.014	.018	.020
		220 - 260	60	.008	.012	.015	.017
		260 - 320	45	.008	.010	.012	.014
N	Aluminum	30	275	.018	.026	.032	.042
		180	200	.018	.026	.032	.042

#### Deep Hole Drilling Speed and Feed Adjustment

	Holder Length	
	Long	XL
Speed	0.90	0.80
Feed	-	0.90

#### Recommended Speed and Feed Example

If the recommended speed and feed is 100 SFM and 0.016 IPR for a standard length holder, then the speed and feed using an XL holder in the same application would be 80 SFM and 0.014 IPR.

$100 \cdot 0.80 = 80 \text{ SFM}$	$0.016 \cdot 0.90 = 0.014 \text{ IPR}$
-----------------------------------	--

#### 1. WARNING Tool failure can cause serious injury. To prevent:

- When using holders without support bushing, use a short length holder to establish an initial hole that is a minimum of 2 diameters deep.
- Do not rotate tool holders more than 50 RPM unless it is engaged with the workpiece or fixture.

Refer to page A40: 48 for Deep Hole Drilling Guidelines. Visit [www.alliedmachine.com/DeepHoleGuidelines](http://www.alliedmachine.com/DeepHoleGuidelines) for the most up-to-date information and procedures. Factory technical assistance is available for your specific applications through our Application Engineering Team.

**IMPORTANT:** The speeds and feeds listed above are a general starting point for all applications. Refer to the Coolant Recommendation chart for coolant requirements to run at the recommended speeds and feeds. Factory technical assistance is available through our Application Engineering department. See adjustment examples on the following page.



## Coolant Recommendations | Imperial (inch)

### Universal Spade Inserts

ISO	Material	Data Metrics	Data by Diameter			
			1 - 1-1/4	1-1/4 - 2	2 - 3	3 - 5
P	Free Machining Steel 1118, 1215, 12L14, etc.	Hardness (BHN)	100 - 250	100 - 250	100 - 250	100 - 250
		Coolant Pressure (PSI)	40	25	25	20
		Coolant Volumetric Flow Rate (GPM)	3.9	10	23	35
	Low Carbon Steel	Hardness (BHN)	85 - 275	85 - 275	85 - 275	85 - 275
		Coolant Pressure (PSI)	30	20	20	20
		Coolant Volumetric Flow Rate (GPM)	3.4	9	21	35
	Medium Carbon Steel	Hardness (BHN)	125 - 325	125 - 325	125 - 325	125 - 325
		Coolant Pressure (PSI)	25	20	20	20
		Coolant Volumetric Flow Rate (GPM)	3.1	9	21	35
	Alloy Steel	Hardness (BHN)	125 - 375	125 - 375	125 - 375	125 - 375
		Coolant Pressure (PSI)	20	20	20	20
		Coolant Volumetric Flow Rate (GPM)	2.8	9	21	35
	High Strength Alloy 4340, 4330V, 300M, etc.	Hardness (BHN)	225 - 400	225 - 400	225 - 400	225 - 400
		Coolant Pressure (PSI)	25	20	20	20
		Coolant Volumetric Flow Rate (GPM)	3.1	9	21	35
	Structural Steel A36, A285, A516, etc.	Hardness (BHN)	100 - 350	100 - 350	100 - 350	100 - 350
		Coolant Pressure (PSI)	25	20	20	20
		Coolant Volumetric Flow Rate (GPM)	3.1	9	21	35
Tool Steel H-13, H-21, A-4, O-2, S-3, etc.	Hardness (BHN)	150 - 250	150 - 250	150 - 250	150 - 250	
	Coolant Pressure (PSI)	25	20	20	20	
	Coolant Volumetric Flow Rate (GPM)	3.1	9	21	35	
S	High Temp Alloy Hastelloy B, Inconel 600, etc.	Hardness (BHN)	140 - 310	140 - 310	140 - 310	140 - 310
		Coolant Pressure (PSI)	25	20	20	20
		Coolant Volumetric Flow Rate (GPM)	3.1	9	21	35
M	Stainless Steel 303, 416, 420, 17-4 PH, etc.	Hardness (BHN)	135 - 275	135 - 275	135 - 275	135 - 275
		Coolant Pressure (PSI)	25	25	20	20
		Coolant Volumetric Flow Rate (GPM)	3.1	10	21	35
K	Cast Iron	Hardness (BHN)	120 - 320	120 - 320	120 - 320	120 - 320
		Coolant Pressure (PSI)	25	20	20	20
		Coolant Volumetric Flow Rate (GPM)	3.1	9	21	35
N	Aluminum	Hardness (BHN)	30 - 180	30 - 180	30 - 180	30 - 180
		Coolant Pressure (PSI)	55	35	30	30
		Coolant Volumetric Flow Rate (GPM)	4.6	12	26	40

#### Deep Hole Drilling Speed and Feed Adjustment

	Holder Length	
	Long	XL
Pressure and Flow	1.3	2

#### Recommended Speed and Feed Example

If the recommended pressure and flow is 150 PSI and 6.3 GPM for a standard length holder, then the adjusted pressure and flow using an XL holder in the same application would be 300 PSI and 12.6 GPM.

$150 \cdot 2 = 300 \text{ PSI}$	$6.3 \cdot 2 = 12.6 \text{ GPM}$
---------------------------------	----------------------------------

**⚠ WARNING** Tool failure can cause serious injury. To prevent:

- When using holders without support bushing, use a short length holder to establish an initial hole that is a minimum of 2 diameters deep.
- Do not rotate tool holders more than 50 RPM unless it is engaged with the workpiece or fixture.

Refer to page A40: 48 for Deep Hole Drilling Guidelines. Visit [www.alliedmachine.com/DeepHoleGuidelines](http://www.alliedmachine.com/DeepHoleGuidelines) for the most up-to-date information and procedures. Factory technical assistance is available for your specific applications through our Application Engineering Team.

**IMPORTANT:** The coolant pressure and flow rate recommendation below represents a good approximation to obtain optimum tool life and chip evacuation at the recommended speeds and feeds. If lower coolant capabilities exist in a drilling application, the HP/Universal drilling system will still function at reduced penetration rates. Contact our Application Engineering department for more specific recommendations of coolant requirements and/or speeds and feeds.

A  
DRILLING  
B  
BORING  
C  
REAMING  
D  
BURNISHING  
E  
THREADING  
X  
SPECIALS



## Deep Hole Drilling Guidelines

A

DRILLING

- 1. Pilot Hole**  
100% RPM  
100% IPR (mm/rev)

Establish the pilot hole using the same diameter short drill to a depth of 2xD minimum. Utilize a pilot drill with the same or larger included point angle.

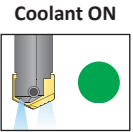
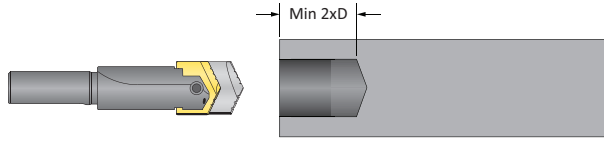

B

BORING

- 2. Feed-in**  
50 RPM max  
12 IPM (300 mm/min)

Feed the longer drill within 1/16" (1.5mm) short of the established pilot hole bottom at a **maximum of 50 RPM** and 12 IPM (300 mm/min) feed rate.

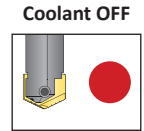
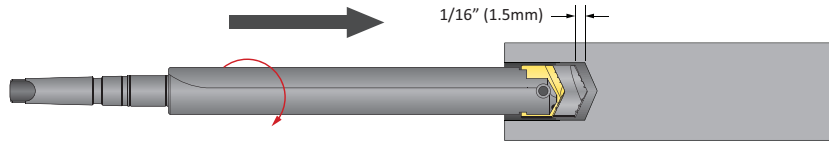

C

REAMING

- 3. Deep Hole Transition Drilling**  
50% RPM  
75% IPR (mm/rev)

Drill additional 1xD past the bottom of the pilot hole at 50% reduction of recommended speed and 25% reduction of recommended feed. Minimum of 1 second dwell is required to meet full speed before feeding.

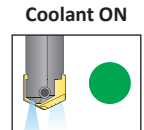
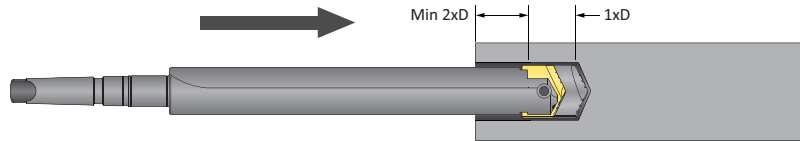

D

BURNISHING

- 4. Deep Hole Drilling - Blind**  
100% RPM  
100% IPR (mm/rev)

Drill to full depth at recommended speed and feed for longer drill according to Allied speed and feed charts. **No peck cycle recommended.**

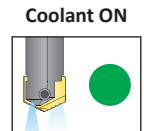
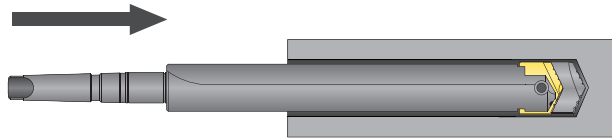

E

THREADING

- 6. Drill Retract**  
50 RPM max

Reduce speed to a **maximum of 50 RPM** before retracting from the hole.

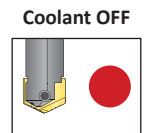
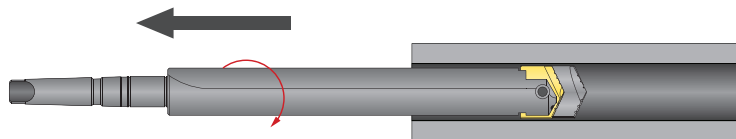

X

SPECIALS

**1. WARNING** Tool failure can cause serious injury. To prevent:

- When using holders without support bushing, use a short length holder to establish an initial hole that is a minimum of 2 diameters deep.
- Do not rotate tool holders more than 50 RPM unless it is engaged with the workpiece or fixture.

Visit [www.alliedmachine.com/DeepHoleGuidelines](http://www.alliedmachine.com/DeepHoleGuidelines) for the most up-to-date information and procedures. Factory technical assistance is available for your specific applications through our Application Engineering Team.





SECTION

---

# A50

---

APX™ Drill

# APX™ Drill

## Deep Hole / Large Diameter Drilling System

▶ Diameter Range: 1.2992" - 4.0000" (33.00mm - 101.60mm)



### Don't Let Your Machine Slow You Down

The APX deep hole/large diameter drilling system delivers the strength and versatility needed for any deep hole drilling application. The breakthrough geometry is designed to increase penetration rates and tool life. By allowing for higher spindle speeds, the APX lets you take advantage of the power curve on modern CNC machines.

Excellent chip control	Improves hole quality and surface finish	Provides maximum durability and stability
------------------------	--	---

### Applicable Industries

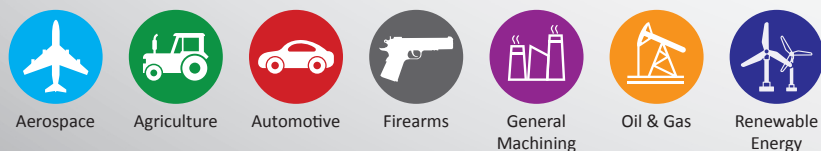

Your safety and the safety of others is very important. This catalog contains important safety messages. Always read and follow all safety precautions.



This triangle is a safety hazard symbol. It alerts you to potential safety hazards that can cause tool failure and serious injury.

When you see this symbol in the catalog, look for a related safety message that may be near this triangle or referred to in the nearby text.

There are safety signal words also used in the catalog. Safety messages follow these words.

#### **WARNING**

**WARNING** (shown above) means that failure to follow the precautions in this message could result in tool failure and serious injury.

**NOTICE** means that failure to follow the precautions in this message could result in damage to the tool or machine but not result in personal injury.

**NOTE** and **IMPORTANT** are also used. These are important that you read and follow but are not safety-related.

Visit [www.alliedmachine.com](http://www.alliedmachine.com) for the most up-to-date information and procedures.

**Reference Icons**

The following icons will appear throughout the catalog to help you navigate between products.



**Setup / Assembly Information**  
Detailed instructions and information regarding the corresponding part(s)

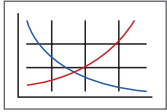

**Recommended Cutting Data**  
Speed and feed recommendations for optimum and safe drilling

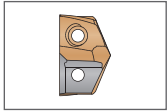

**GEN3SYS® Pilot Inserts**  
Lists the GEN3SYS XT pilot insert options for each APX Drill series

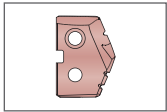

**T-A® Pilot Inserts**  
Lists the Original T-A® and GEN2 T-A® pilot insert options for each APX Drill series

Series	Diameter Range	
	Imperial (inch)	Metric (mm)
33	1.2992 - 1.4960	33.00 - 37.99
38	1.4691 - 1.7322	38.00 - 43.99
44	1.7323 - 2.0078	44.00 - 50.99
51	2.0079 - 2.2440	51.00 - 56.99
57	2.2441 - 2.4802	57.00 - 62.99
63	2.4803 - 2.7558	63.00 - 69.99
70	2.7559 - 2.9920	70.00 - 75.99
76	2.9921 - 3.2676	76.00 - 82.99
83	3.2677 - 3.5038	83.00 - 88.99
89	3.5039 - 3.7401	89.00 - 94.99
95	3.7402 - 4.0000	95.00 - 101.60

**Introduction Information**

Drill Selection Guide / Assembly Details . . . . . 2 - 3  
 Pilot Insert Options / Details . . . . . 4  
 Product Nomenclature . . . . . 5















**Drill Series**



33 Series . . . . . 6 - 7  
 38 Series . . . . . 8 - 9  
 44 Series . . . . . 10 - 11  
 51 Series . . . . . 12 - 13  
 57 Series . . . . . 14 - 15  
 63 Series . . . . . 16 - 17  
 70 Series . . . . . 18 - 19  
 76 Series . . . . . 20 - 21  
 83 Series . . . . . 22 - 23  
 89 Series . . . . . 24 - 25  
 95 Series . . . . . 26 - 27

**Recommended Cutting Data**



Imperial (inch) . . . . . 28  
 Metric (mm) . . . . . 29  
 Deep Hole Drilling Guidelines . . . . . 30

## Drill Selection Guide

Series	33	38	44	51	57
					
Page	6 - 7	8 - 9	10 - 11	12 - 13	14 - 15
D <sub>5</sub> inch	1.2992 - 1.4960	1.4691 - 1.7322	1.7323 - 2.0078	2.0079 - 2.2440	2.2441 - 2.4802
D <sub>5</sub> mm	33.00 - 37.99	38.00 - 43.99	44.00 - 50.99	51.00 - 56.99	57.00 - 62.99
ISO Material					
IC Insert Shape					
IC Insert Size	5/16"	3/8"	3/8", 1/2"	1/2", 9/16"	9/16"
Wear Pads	NO	NO	NO	NO	NO
<b>Holders</b>					
Drill Depth (inch)	4-7/16 - 14-29/32	5-1/8 - 17-1/4	6 - 20-1/8	6-3/8 - 22-3/8	7-1/8 - 24-3/4
Drill Depth (mm)	112.6 - 378.6	130.5 - 439.9	151.5 - 510.0	161.8 - 570.0	179.9 - 626.9
<b>Pilot Insert</b>					
T-A Series	0, 1	0, 1	1	1	1, 2
GEN3SYS XT Series	16, 18, 20	15, 17, 18, 20	17, 18, 22	18, 20, 22	22, 24, 26

	<p><b>T-A® Style Pilot Insert Head</b></p> <ul style="list-style-type: none"> <li>Utilizes both Original T-A® and GEN2 T-A® inserts (0 - 2 series)</li> <li>Multiple geometry options are available to achieve optimal results in different types of applications</li> </ul>		<p><b>GEN3SYS® XT Style Pilot Insert Head</b></p> <ul style="list-style-type: none"> <li>Utilizes GEN3SYS® XT inserts (15 - 32 series)</li> <li>Multiple geometry options are available to achieve optimal results in different types of applications</li> </ul>
---	--	--	--

	<b>Insert Application Recommendations</b>	
	<b>Carbide Grade Options</b>	
	C5 (P35)	General purpose carbide grade suitable for most applications. ▶ <i>Common application in steels and stainless steels.</i>
	C1 (K35)	Toughest carbide grade. Provides the best combination of edge strength and tool life. ▶ <i>Recommended for less rigid applications.</i>
<p><b>IC Insert AM300®</b></p> <ul style="list-style-type: none"> <li>The design allows for excellent chip control and aggressive penetration rates</li> <li>The proprietary AM300® coatings increase tool life above competitors' premium coatings</li> </ul>	C2 (K25)	Higher wear resistant carbide suitable for abrasive material applications. ▶ <i>Recommended for grey, ductile, and nodular irons.</i>
	<b>Additional Geometry Option</b>	
	High Rake (HR)	Provides superior chip control and tool life in long chipping carbon and alloy steels below 200 Bhn.

	
Flanged Straight Shank	CAT40 / CAT50 Integral Shank



63	70	76	83	89	95
					
16 - 17	18 - 19	20 - 21	22 - 23	24 - 25	26 - 27
2.4803 - 2.7558	2.7559 - 2.9920	2.9921 - 3.2676	3.2677 - 3.5038	3.5039 - 3.7401	3.7402 - 4.0000
63.00 - 69.99	70.00 - 75.99	76.00 - 82.99	83.00 - 88.99	89.00 - 94.99	95.00 - 101.60
					
					
9/16"	3/8"	1/2"	1/2"	9/16"	9/16"
NO	YES	YES	YES	YES	YES
7-7/8 - 27-1/8	8-3/4 - 27-7/8	9-1/2 - 26-1/8	10-1/8 - 27-3/4	10-7/8 - 27-5/8	11-7/8 - 27-1/2
200.8 - 688.3	218.8 - 709.4	239.9 - 664.0	257.8 - 704.9	275.8 - 701.8	302.0 - 698.5
2	2	2	2	2	2
26, 29, 32	29	29	32	29	32



**Step 1:**

Lower the APX head assembly onto the APX holder.



**Step 2:**

Insert the head mounting screws into points A and B. Tighten until the head is properly secured to the holder.

**Step 3:**

Tighten with the head mounting driver using the torque setting chart below.

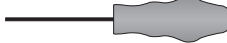
**Torque Setting Chart**

Series	Screw	Driver	Torque
33 - 63	75020-IP20-1	 8IP-20	60 in-lb (678 N-cm)
70 - 95	78027-IP30-1	 8IP-30B	250 in-lb (2825 N-cm)



## Pilot Insert Options

A  
DRILLING  
B  
BORING  
C  
REAMING  
D  
BURNISHING  
E  
THREADING  
X  
SPECIALS

### T-A® Pilot Inserts

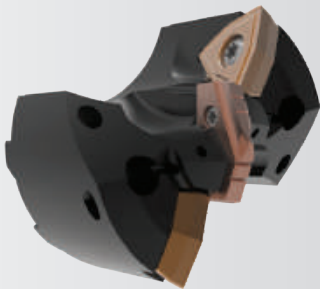

### GEN3SYS® XT Pilot Inserts

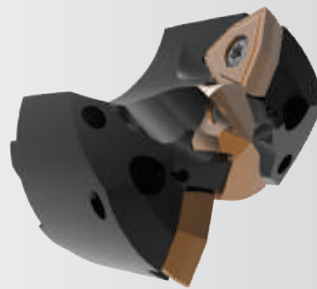

#### GEN2 T-A Standard

- Designed for rigid machining applications, primarily used for drilling exotic and high alloy materials
- Ideal for general use when the surface speed needs to be increased

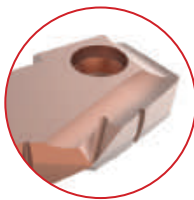

#### Standard Geometry

- Designed with corner and cutting edge enhancements to deliver more reliability, durability, and productivity
- Increases penetration rates and tool life
- Available in C1 or C2 carbide

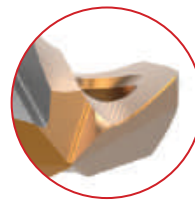

#### GEN2 T-A High Efficiency (-HE)

- Designed for improved chip formation in elastic materials like low carbon steels
- Maximizes performance and increases value

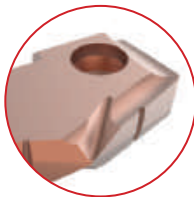

#### Cast Iron Geometry (-CI)

- Increases durability and tool life in ductile, nodular, and grey cast irons
- Available in C2 carbide



#### Original T-A Standard

- Excellent choice for general purpose use
- Provides fast penetration rates that produce good hole size and finish
- Combines highly efficient, stable cutting action to minimize power consumption

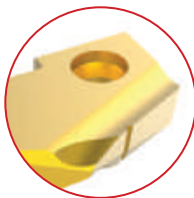

#### Low Rake Geometry (-LR)

- The toughest XT geometry available
- Designed for harder steels and less than ideal machining applications
- Available in C1 or C2 carbide

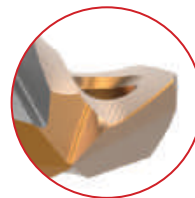

#### Original T-A Tiny Chip (-TC)

- Unique lip and point design for excellent chip control
- Improved capabilities in long-chipping materials such as low carbon steels and soft alloy steels
- Enhanced performance in lower powered machines for better chip formation at lower feed rates

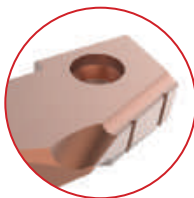

#### Stainless Steel Geometry (-AS)

- Designed with a specific geometry to provide unmatched chip control and tool life in austenitic and PH stainless steels, as well as high temperature alloys such as Inconel, Hastelloy, and Titanium alloys
- Available in C2 carbide

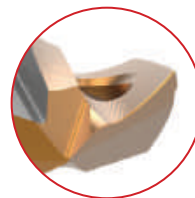

#### Original T-A High Impact (-HI)

- Designed to enhance chip formation in materials with high elasticity/ductility and poor chip forming characteristics
- SK2 corner preparation for increased tool life
- Improves chip formation in structural, cast, and forged steels

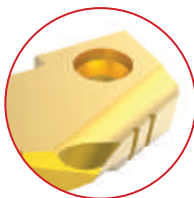

**NOTE:** For a complete offering of pilot inserts, see sections **A20** (GEN3SYS Drilling Systems) and **A30** (T-A Drilling Systems) of our catalog.

## Product Nomenclature

### APX Drill Heads

<b>V</b>	<b>38</b>	<b>15</b>	<b>D</b>	-	<b>0116</b>
1	2	3	4		5

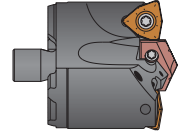

1. APX Head	2. Series	3. Pilot Series																														
V = Head	<table border="0"> <tr> <td>33 = 33 series</td> <td>70 = 70 series</td> </tr> <tr> <td>38 = 38 series</td> <td>76 = 76 series</td> </tr> <tr> <td>44 = 44 series</td> <td>83 = 83 series</td> </tr> <tr> <td>51 = 51 series</td> <td>89 = 89 series</td> </tr> <tr> <td>57 = 57 series</td> <td>95 = 95 series</td> </tr> <tr> <td>63 = 63 series</td> <td></td> </tr> </table>	33 = 33 series	70 = 70 series	38 = 38 series	76 = 76 series	44 = 44 series	83 = 83 series	51 = 51 series	89 = 89 series	57 = 57 series	95 = 95 series	63 = 63 series		<table border="0"> <tr> <th>T-A® Pilot Insert</th> <th colspan="2">GEN3SYS® XT Pilot Insert</th> </tr> <tr> <td>00 = 0 series</td> <td>15 = 15 series</td> <td>24 = 24 series</td> </tr> <tr> <td>01 = 1 series</td> <td>17 = 17 series</td> <td>26 = 26 series</td> </tr> <tr> <td>02 = 2 series</td> <td>18 = 18 series</td> <td>29 = 29 series</td> </tr> <tr> <td></td> <td>20 = 20 series</td> <td>32 = 32 series</td> </tr> <tr> <td></td> <td>22 = 22 series</td> <td></td> </tr> </table>	T-A® Pilot Insert	GEN3SYS® XT Pilot Insert		00 = 0 series	15 = 15 series	24 = 24 series	01 = 1 series	17 = 17 series	26 = 26 series	02 = 2 series	18 = 18 series	29 = 29 series		20 = 20 series	32 = 32 series		22 = 22 series	
33 = 33 series	70 = 70 series																															
38 = 38 series	76 = 76 series																															
44 = 44 series	83 = 83 series																															
51 = 51 series	89 = 89 series																															
57 = 57 series	95 = 95 series																															
63 = 63 series																																
T-A® Pilot Insert	GEN3SYS® XT Pilot Insert																															
00 = 0 series	15 = 15 series	24 = 24 series																														
01 = 1 series	17 = 17 series	26 = 26 series																														
02 = 2 series	18 = 18 series	29 = 29 series																														
	20 = 20 series	32 = 32 series																														
	22 = 22 series																															

4. Effective Cutting	5. Major Diameter
D = Double effective S = Single effective	0116 = Inch 1.5153 = Decimal 68 = Metric

#### Ordering Non-Stocked Diameters:

Non-stocked diameters are also available. Please refer to the price list for applicable process fees. Follow the ordering examples below:

- Inch: 38 series, T-A (1 series), 1.6790" = **V3801D-1.6790**
- Metric: 38 series, T-A (1 series), 42.15mm = **V3801D-42.15**

### APX Drill Holders

<b>W</b>	<b>38</b>	<b>05</b>	<b>H</b>	-	<b>200F</b>
1	2	3	4		5

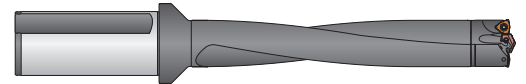

1. APX Holder	2. Series	3. Drill Length	4. Flute Style	5. Shank																						
W = Holder	<table border="0"> <tr> <td>33 = 33 series</td> <td>70 = 70 series</td> </tr> <tr> <td>38 = 38 series</td> <td>76 = 76 series</td> </tr> <tr> <td>44 = 44 series</td> <td>83 = 83 series</td> </tr> <tr> <td>51 = 51 series</td> <td>89 = 89 series</td> </tr> <tr> <td>57 = 57 series</td> <td>95 = 95 series</td> </tr> <tr> <td>63 = 63 series</td> <td></td> </tr> </table>	33 = 33 series	70 = 70 series	38 = 38 series	76 = 76 series	44 = 44 series	83 = 83 series	51 = 51 series	89 = 89 series	57 = 57 series	95 = 95 series	63 = 63 series		<table border="0"> <tr> <td>03 = 3xD</td> </tr> <tr> <td>05 = 5xD</td> </tr> <tr> <td>08 = 8xD</td> </tr> <tr> <td>10 = 10xD</td> </tr> </table>	03 = 3xD	05 = 5xD	08 = 8xD	10 = 10xD	H = Helical	<table border="0"> <tr> <td>150F = 1-1/2" flanged straight shank</td> </tr> <tr> <td>200F = 2" flanged straight shank</td> </tr> <tr> <td>40FM = 40mm flanged straight shank</td> </tr> <tr> <td>50FM = 50mm flanged straight shank</td> </tr> <tr> <td>CV40 = CAT40 integral shank</td> </tr> <tr> <td>CV50 = CAT50 integral shank</td> </tr> </table>	150F = 1-1/2" flanged straight shank	200F = 2" flanged straight shank	40FM = 40mm flanged straight shank	50FM = 50mm flanged straight shank	CV40 = CAT40 integral shank	CV50 = CAT50 integral shank
33 = 33 series	70 = 70 series																									
38 = 38 series	76 = 76 series																									
44 = 44 series	83 = 83 series																									
51 = 51 series	89 = 89 series																									
57 = 57 series	95 = 95 series																									
63 = 63 series																										
03 = 3xD																										
05 = 5xD																										
08 = 8xD																										
10 = 10xD																										
150F = 1-1/2" flanged straight shank																										
200F = 2" flanged straight shank																										
40FM = 40mm flanged straight shank																										
50FM = 50mm flanged straight shank																										
CV40 = CAT40 integral shank																										
CV50 = CAT50 integral shank																										

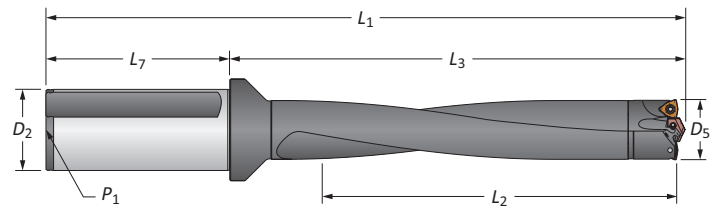
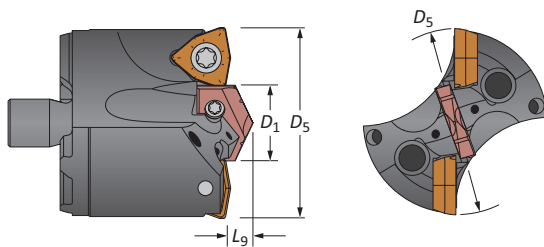

#### Reference Key

Symbol	Attribute
D <sub>1</sub>	Pilot insert diameter
D <sub>5</sub>	Major cutting diameter
L <sub>9</sub>	Pilot insert length

#### Reference Key



Symbol	Attribute	Symbol	Attribute
D <sub>2</sub>	Shank diameter	L <sub>3</sub>	Holder reference length
D <sub>5</sub>	Drill diameter range	L <sub>7</sub>	Shank length
L <sub>1</sub>	Overall length	P <sub>1</sub>	Rear pipe tap
L <sub>2</sub>	Drill depth		

**APX Drill Heads**

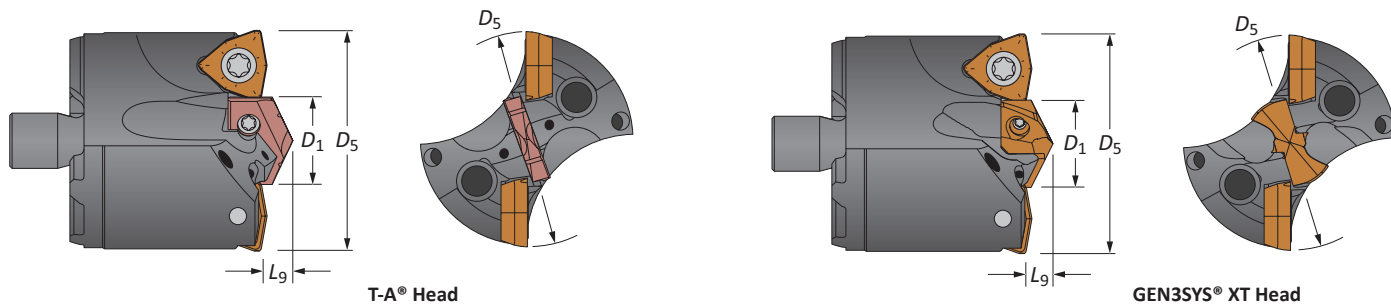
33 Series | Diameter Range: 1.2992" - 1.4960" (33.00mm - 37.99mm)





**Heads**

Head					T-A Head				GEN3SYS XT Head			
D <sub>5</sub> fractional	D <sub>5</sub> inch	D <sub>5</sub> mm	D <sub>1</sub>	L <sub>9</sub>	Part No.	Pilot Series	 GEN2 T-A Insert	 T-A (-TC) Insert	Part No.	Pilot Series	 Pilot Insert	IC Insert Size
-	1.2992	33.00	16	1/4	<b>V3300D-33</b>	0	4C*0H-16	1C10H-16-TC	<b>V3316D-33</b>	16	7C*16P-16	5/16
1-5/16	1.3125	33.34	16	1/4	<b>V3300D-0110</b>	0	4C*0H-16	1C10H-16-TC	<b>V3316D-0110</b>	16	7C*16P-16	5/16
-	1.3386	34.00	18	1/4	<b>V3301D-34</b>	1	4C*1H-18	1C11H-18-TC	<b>V3318D-34</b>	18	7C*18P-18	5/16
1-11/32	1.3438	34.13	18	1/4	<b>V3301D-0111</b>	1	4C*1H-18	1C11H-18-TC	<b>V3318D-0111</b>	18	7C*18P-18	5/16
1-3/8	1.3750	34.93	18	1/4	<b>V3301D-0112</b>	1	4C*1H-18	1C11H-18-TC	<b>V3318D-0112</b>	18	7C*18P-18	5/16
-	1.3780	35.00	18	1/4	<b>V3301D-35</b>	1	4C*1H-18	1C11H-18-TC	<b>V3318D-35</b>	18	7C*18P-18	5/16
1-13/32	1.4063	35.72	18	1/4	<b>V3301D-0113</b>	1	4C*1H-18	1C11H-18-TC	<b>V3318D-0113</b>	18	7C*18P-18	5/16
-	1.4173	36.00	20	1/4	<b>V3301D-36</b>	1	4C*1H-20	1C11H-20-TC	<b>V3320D-36</b>	20	7C*20P-20	5/16
1-7/16	1.4375	36.51	20	1/4	<b>V3301D-0114</b>	1	4C*1H-20	1C11H-20-TC	<b>V3320D-0114</b>	20	7C*20P-20	5/16
-	1.4567	37.00	20	1/4	<b>V3301D-37</b>	1	4C*1H-20	1C11H-20-TC	<b>V3320D-37</b>	20	7C*20P-20	5/16
1-15/32	1.4688	37.31	20	1/4	<b>V3301D-0115</b>	1	4C*1H-20	1C11H-20-TC	<b>V3320D-0115</b>	20	7C*20P-20	5/16



\*Denotes carbide grade (1 = C1, 2 = C2)

**IC Inserts**



Coating	Size	Grade	Geometry	 Part No.	 Insert Screw	 Insert Driver	Admissible Tightening Torque*
AM300®	5/16	C5 (P35)	Standard	<b>OP-05T308-PW</b>	IS-10-1	8IP-10	27.0 in-lbs (305 N-cm)
AM300®	5/16	C1 (K35)	Standard	<b>OP-05T308-1PW</b>	IS-10-1	8IP-10	27.0 in-lbs (305 N-cm)
AM300®	5/16	C2 (K25)	Standard	<b>OP-05T308-2PW</b>	IS-10-1	8IP-10	27.0 in-lbs (305 N-cm)
AM300®	5/16	C5 (P35)	High Rake	<b>OP-05T308-PWHR</b>	IS-10-1	8IP-10	27.0 in-lbs (305 N-cm)

\*Tightening torques are calculated with a friction coefficient of  $\mu = 0.14$  and develop 90% of ultimate yield strength

**Pilot Accessories**

Pilot Style	Series	 Insert Screws	 Insert Driver	Admissible Tightening Torque*
T-A	0	72567-IP8-1	8IP-8	15.5 in-lbs (175 N-cm)
T-A	1	7375-IP9-1	8IP-9	27.0 in-lbs (305 N-cm)
GEN3SYS	16	72556-IP8-1	8IP-8	15.5 in-lbs (175 N-cm)
GEN3SYS	18	7375-IP9-1	8IP-9	27.0 in-lbs (305 N-cm)
GEN3SYS	20	7375-IP9-1	8IP-9	27.0 in-lbs (305 N-cm)

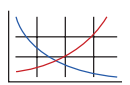
\*Tightening torques are calculated with a friction coefficient of  $\mu = 0.14$  and develop 90% of ultimate yield strength

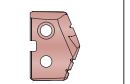
A50: 28 - 29  A50: 2 - 5  Section A20  Section A30 

Non-stocked diameters are also available. Follow the examples shown below.

<b>Inch</b>	38 series, T-A (1 series), 1.6790"	Part No. = <b>V3801D-1.6790</b>
<b>Metric</b>	38 series, T-A (1 series), 42.15mm	Part No. = <b>V3801D-42.15</b>

IC inserts sold in multiples of 2 | Insert screws sold in multiples of 10

A DRILLING  
B BORING  
C REAMING  
D BURNISHING  
E THREADING  
X SPECIALS

## APX Drill Holders

33 Series | Diameter Range: 1.2992" - 1.4960" (33.00mm - 37.99mm)

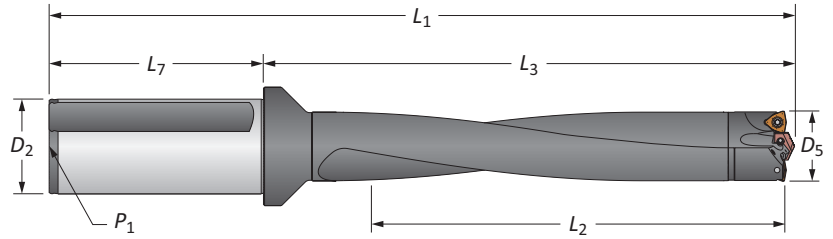

### Straight Shank

	Length	D <sub>5</sub>	Body			Shank			Part No.
			L <sub>2</sub>	L <sub>3</sub>	L <sub>1</sub>	L <sub>7</sub>	D <sub>2</sub>	P <sub>1</sub>	
i	3xD	1.2992 - 1.4690	4-7/16	6-19/32	9-9/32	2-11/16	1-1/2	1/4	W3303H-150F
	5xD	1.2992 - 1.4690	7-27/64	9-37/64	12-9/32	2-11/16	1-1/2	1/4	W3305H-150F
	8xD	1.2992 - 1.4690	11-59/64	14-5/64	16-3/4	2-11/16	1-1/2	1/4	W3308H-150F
	10xD	1.2992 - 1.4690	14-29/32	17-1/16	19-3/4	2-11/16	1-1/2	1/4	W3310H-150F
m	3xD	33.00 - 37.99	112.6	167.4	237.4	70.0	40.0	1/4*	W3303H-40FM
	5xD	33.00 - 37.99	188.6	243.4	313.4	70.0	40.0	1/4*	W3305H-40FM
	8xD	33.00 - 37.99	302.6	357.4	427.4	70.0	40.0	1/4*	W3308H-40FM
	10xD	33.00 - 37.99	378.6	433.4	503.4	70.0	40.0	1/4*	W3310H-40FM

\*Thread to BSP and ISO 7-1

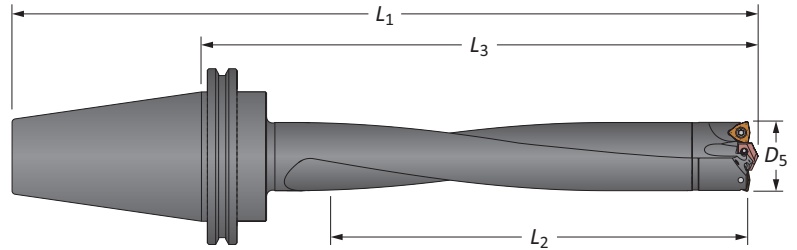

### CAT Integral Shank

	Length	D <sub>5</sub>		Body			Shank	Part No.
		inch	mm	L <sub>2</sub>	L <sub>3</sub>	L <sub>1</sub>		
i	3xD	1.2992 - 1.4690	33.00 - 37.99	4-7/16	7-3/8	10-3/16	CV40	W3303H-CV40
	5xD	1.2992 - 1.4690	33.00 - 37.99	7-27/64	10-23/64	13-11/64	CV40	W3305H-CV40
	8xD	1.2992 - 1.4690	33.00 - 37.99	11-59/64	14-55/64	17-21/32	CV40	W3308H-CV40
	10xD	1.2992 - 1.4690	33.00 - 37.99	14-29/32	17-27/32	20-21/32	CV40	W3310H-CV40
	3xD	1.2992 - 1.4690	33.00 - 37.99	4-7/16	7-3/8	11-1/2	CV50	W3303H-CV50
	5xD	1.2992 - 1.4690	33.00 - 37.99	7-27/64	10-23/64	14-31/64	CV50	W3305H-CV50
	8xD	1.2992 - 1.4690	33.00 - 37.99	11-59/64	14-55/64	18-31/32	CV50	W3308H-CV50
	10xD	1.2992 - 1.4690	33.00 - 37.99	14-29/32	17-27/32	21-31/32	CV50	W3310H-CV50

### Connection Accessories

<b>Mounting Screw</b>	<b>Mounting Screw Driver</b>	<b>Admissible Tightening Torque*</b>
75020-IP20-1	8IP-20	60 in-lb (678 N-cm)

\*Tightening torques are calculated with a friction coefficient of  $\mu = 0.14$  and develop 90% of ultimate yield strength

**WARNING** Refer to Speed and Feed charts for recommended adjustments to speeds and feeds. Refer to page A50: 30 for deep hole drilling guidelines in this section of the catalog. Visit [www.alliedmachine.com/DeepHoleGuidelines](http://www.alliedmachine.com/DeepHoleGuidelines) for the most up-to-date information and procedures. Factory technical assistance is available for your specific applications through our Application Engineering Team.

i = Imperial (in)  
m = Metric (mm)

Mounting screws sold in multiples of 4

APX Drill Heads

38 Series | Diameter Range: 1.4691" - 1.7322" (38.00mm - 43.99mm)

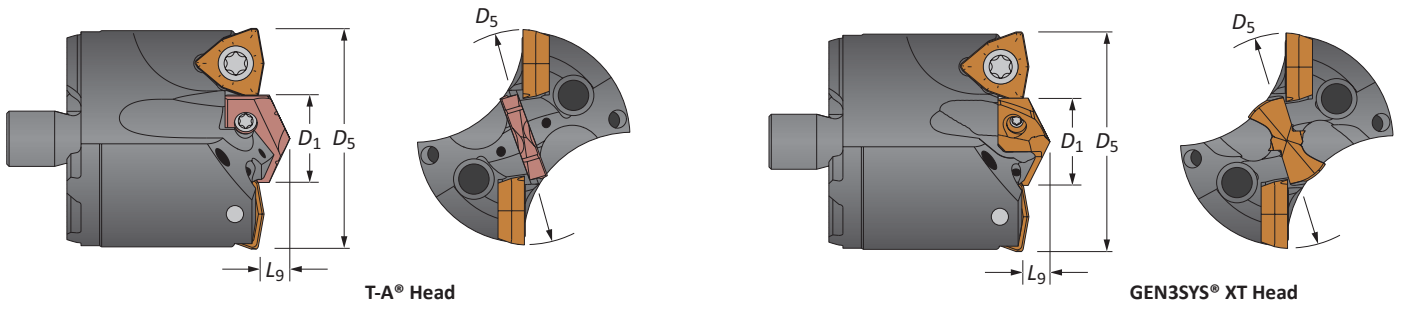

Heads

Head					T-A Head				GEN3SYS XT Head			
D <sub>5</sub> fractional	D <sub>5</sub> inch	D <sub>5</sub> mm	D <sub>1</sub>	L <sub>9</sub>	Part No.	Pilot Series	GEN2 T-A Insert	T-A (-TC) Insert	Part No.	Pilot Series	Pilot Insert	IC Insert Size
-	1.4691	38.00	5/8	19/64	V3800D-38	0	4C*0H-0020	1C10H-0020-TC	V3815D-38	15	7C*15P-0020	3/8
1-1/2	1.5000	38.10	5/8	19/64	V3800D-0116	0	4C*0H-0020	1C10H-0020-TC	V3815D-0116	15	7C*15P-0020	3/8
1-17/32	1.5313	38.90	5/8	19/64	V3800D-0117	0	4C*0H-0020	1C10H-0020-TC	V3815D-0117	15	7C*15P-0020	3/8
-	1.5354	39.00	5/8	19/64	V3800D-39	0	4C*0H-0020	1C10H-0020-TC	V3815D-39	15	7C*15P-0020	3/8
1-9/16	1.5625	39.69	5/8	19/64	V3800D-0118	0	4C*0H-0020	1C10H-0020-TC	V3815D-0118	15	7C*15P-0020	3/8
-	1.5748	40.00	11/16	19/64	V3800D-40	0	4C*0H-0022	1C10H-0022-TC	V3817D-40	17	7C*17P-0022	3/8
1-19/32	1.5938	40.48	11/16	19/64	V3800D-0119	0	4C*0H-0022	1C10H-0022-TC	V3817D-0119	17	7C*17P-0022	3/8
-	1.6142	41.00	11/16	19/64	V3800D-41	0	4C*0H-0022	1C10H-0022-TC	V3817D-41	17	7C*17P-0022	3/8
1-5/8	1.6250	41.28	11/16	19/64	V3800D-0120	0	4C*0H-0022	1C10H-0022-TC	V3817D-0120	17	7C*17P-0022	3/8
-	1.6535	42.00	3/4	19/64	V3801D-42	1	4C*1H-0024	1C11H-0024-TC	V3818D-42	18	7C*18P-0024	3/8
1-21/32	1.6563	42.07	3/4	19/64	V3801D-0121	1	4C*1H-0024	1C11H-0024-TC	V3818D-0121	18	7C*18P-0024	3/8
1-11/16	1.6875	42.86	3/4	19/64	V3801D-0122	1	4C*1H-0024	1C11H-0024-TC	V3818D-0122	18	7C*18P-0024	3/8
-	1.6929	43.00	13/16	19/64	V3801D-43	1	4C*1H-0026	1C11H-0026-TC	V3820D-43	20	7C*20P-0026	3/8
1-23/32	1.7188	43.66	13/16	19/64	V3801D-0123	1	4C*1H-0026	1C11H-0026-TC	V3820D-0123	20	7C*20P-0026	3/8

\*Denotes carbide grade (1 = C1, 2 = C2)

IC Inserts

Coating	Size	Grade	Geometry	Part No.	Insert Screw	Insert Driver	Admissible Tightening Torque*
AM300®	3/8	C5 (P35)	Standard	OP-060408-PW	73595-IP15-1	8IP-15	41.0 in-lbs (465 N-cm)
AM300®	3/8	C1 (K35)	Standard	OP-060408-1PW	73595-IP15-1	8IP-15	41.0 in-lbs (465 N-cm)
AM300®	3/8	C2 (K25)	Standard	OP-060408-2PW	73595-IP15-1	8IP-15	41.0 in-lbs (465 N-cm)
AM300®	3/8	C5 (P35)	High Rake	OP-060408-PWHR	73595-IP15-1	8IP-15	41.0 in-lbs (465 N-cm)

\*Tightening torques are calculated with a friction coefficient of  $\mu = 0.14$  and develop 90% of ultimate yield strength

Pilot Accessories

Pilot Style	Series	Insert Screws	Insert Driver	Admissible Tightening Torque*
T-A	0	72567-IP8-1	8IP-8	15.5 in-lbs (175 N-cm)
T-A	1	7375-IP9-1	8IP-9	27.0 in-lbs (305 N-cm)
GEN3SYS	15	7247-IP7-1	8IP-7	7.4 in-lbs (84 N-cm)
GEN3SYS	17	72567-IP8-1	8IP-8	15.5 in-lbs (175 N-cm)
GEN3SYS	18	7375-IP9-1	8IP-9	27.0 in-lbs (305 N-cm)
GEN3SYS	20	7375-IP9-1	8IP-9	27.0 in-lbs (305 N-cm)

\*Tightening torques are calculated with a friction coefficient of  $\mu = 0.14$  and develop 90% of ultimate yield strength

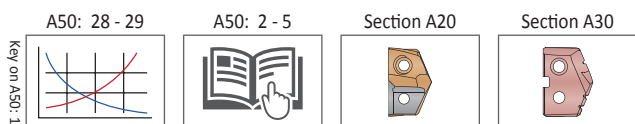

Non-stocked diameters are also available. Follow the examples shown below.

Inch	38 series, T-A (1 series), 1.6790"	Part No. = V3801D-1.6790
Metric	38 series, T-A (1 series), 42.15mm	Part No. = V3801D-42.15

IC inserts sold in multiples of 2 | Insert screws sold in multiples of 10

## APX Drill Holders

38 Series | Diameter Range: 1.4691" - 1.7322" (38.00mm - 43.99mm)

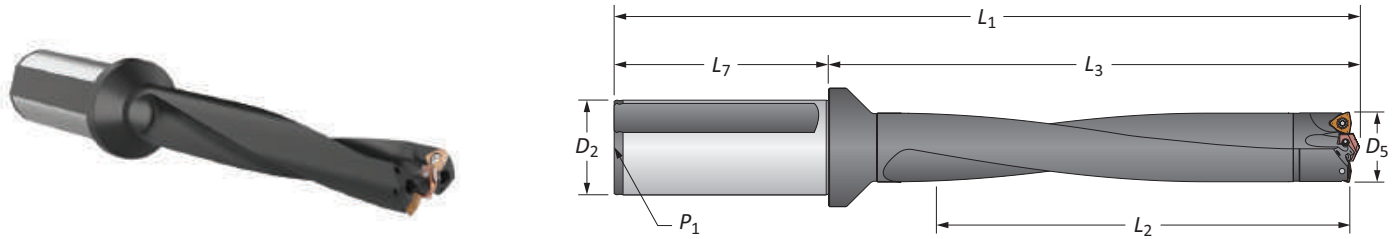

### Straight Shank

	Length	D <sub>5</sub>	Body			Shank			Part No.
			L <sub>2</sub>	L <sub>3</sub>	L <sub>1</sub>	L <sub>7</sub>	D <sub>2</sub>	P <sub>1</sub>	
i	3xD	1.4691 - 1.7322	5-1/8	7-47/64	10-25/64	2-11/16	1-1/2	1/4	W3803H-150F
	5xD	1.4691 - 1.7322	8-5/8	11-13/64	13-55/64	2-11/16	1-1/2	1/4	W3805H-150F
	8xD	1.4691 - 1.7322	13-7/8	16-25/64	19-3/64	2-11/16	1-1/2	1/4	W3808H-150F
	10xD	1.4691 - 1.7322	17-1/4	19-27/32	22-33/64	2-11/16	1-1/2	1/4	W3810H-150F
	3xD	1.4691 - 1.7322	5-1/8	7-47/64	12-15/64	4-1/2	2	1/4	W3803H-200F
	5xD	1.4691 - 1.7322	8-5/8	11-13/64	15-45/64	4-1/2	2	1/4	W3805H-200F
	8xD	1.4691 - 1.7322	13-7/8	16-25/64	20-57/64	4-1/2	2	1/4	W3808H-200F
	10xD	1.4691 - 1.7322	17-1/4	19-27/32	24-59/64	4-1/2	2	1/4	W3810H-200F
m	3xD	38.00 - 43.99	130.5	196.5	265.7	70.0	40.0	1/4*	W3803H-40FM
	5xD	38.00 - 43.99	220.0	284.5	353.7	70.0	40.0	1/4*	W3805H-40FM
	8xD	38.00 - 43.99	352.0	416.5	485.7	70.0	40.0	1/4*	W3808H-40FM
	10xD	38.00 - 43.99	439.9	503.9	573.7	70.0	40.0	1/4*	W3810H-40FM
	3xD	38.00 - 43.99	130.5	196.5	276.5	80.0	50.0	1/4*	W3803H-50FM
	5xD	38.00 - 43.99	220.0	284.5	364.5	80.0	50.0	1/4*	W3805H-50FM
	8xD	38.00 - 43.99	352.0	416.5	496.3	80.0	50.0	1/4*	W3808H-50FM
	10xD	38.00 - 43.99	439.9	503.9	583.9	80.0	50.0	1/4*	W3810H-50FM

\*Thread to BSP and ISO 7-1

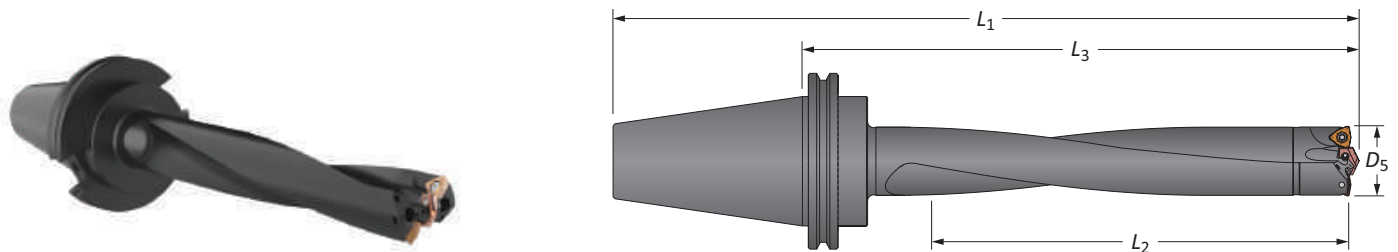

### CAT Integral Shank

	Length	D <sub>5</sub>		Body			Shank	Part No.
		inch	mm	L <sub>2</sub>	L <sub>3</sub>	L <sub>1</sub>		
i	3xD	1.4691 - 1.7322	38.00 - 43.99	5-1/8	8-5/16	11	CV40	W3803H-CV40
	5xD	1.4691 - 1.7322	38.00 - 43.99	8-5/8	11-49/64	14-29/64	CV40	W3805H-CV40
	8xD	1.4691 - 1.7322	38.00 - 43.99	13-7/8	16-31/32	19-21/32	CV40	W3808H-CV40
	10xD	1.4691 - 1.7322	38.00 - 43.99	17-1/4	20-7/16	23-1/8	CV40	W3810H-CV40
	3xD	1.4691 - 1.7322	38.00 - 43.99	5-1/8	8-5/16	12-5/16	CV50	W3803H-CV50
	5xD	1.4691 - 1.7322	38.00 - 43.99	8-5/8	11-49/64	15-49/64	CV50	W3805H-CV50
	8xD	1.4691 - 1.7322	38.00 - 43.99	13-7/8	16-31/32	20-31/32	CV50	W3808H-CV50
	10xD	1.4691 - 1.7322	38.00 - 43.99	17-1/4	20-7/16	24-7/16	CV50	W3810H-CV50

### Connection Accessories

		Admissible Tightening Torque*
Mounting Screw	Mounting Screw Driver	
75020-IP20-1	8IP-20	60 in-lb (678 N-cm)

\*Tightening torques are calculated with a friction coefficient of  $\mu = 0.14$  and develop 90% of ultimate yield strength

**⚠ WARNING** Refer to Speed and Feed charts for recommended adjustments to speeds and feeds. Refer to page A50: 30 for deep hole drilling guidelines in this section of the catalog. Visit [www.alliedmachine.com/DeepHoleGuidelines](http://www.alliedmachine.com/DeepHoleGuidelines) for the most up-to-date information and procedures. Factory technical assistance is available for your specific applications through our Application Engineering Team.

i = Imperial (in)  
m = Metric (mm)

Mounting screws sold in multiples of 4

APX Drill Heads

44 Series | Diameter Range: 1.7323" - 2.0078" (44.00mm - 50.99mm)

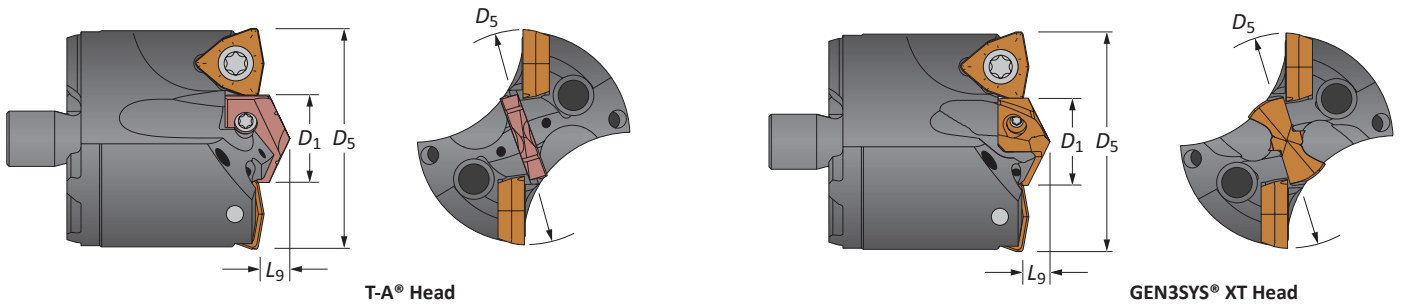

Heads

Head					T-A Head				GEN3SYS XT Head			
D <sub>5</sub> fractional	D <sub>5</sub> inch	D <sub>5</sub> mm	D <sub>1</sub>	L <sub>9</sub>	Part No.	Pilot Series	GEN2 T-A Insert	T-A (-TC) Insert	Part No.	Pilot Series	Pilot Insert	IC Insert Size
-	1.7323	44.00	7/8	21/64	V4401D-44	1	4C*1H-0028	1C11H-0028-TC	V4422D-44	22	7C*22P-0028	3/8
1-3/4	1.7500	44.45	7/8	21/64	V4401D-0124	1	4C*1H-0028	1C11H-0028-TC	V4422D-0124	22	7C*22P-0028	3/8
-	1.7717	45.00	7/8	21/64	V4401D-45	1	4C*1H-0028	1C11H-0028-TC	V4422D-45	22	7C*22P-0028	3/8
1-25/32	1.7813	45.25	7/8	21/64	V4401D-0125	1	4C*1H-0028	1C11H-0028-TC	V4422D-0125	22	7C*22P-0028	3/8
-	1.8110	46.00	15/16	21/64	V4401D-46	1	4C*1H-0030	1C11H-0030-TC	V4422D-46	22	7C*22P-0030	3/8
1-13/16	1.8125	46.04	15/16	21/64	V4401D-0126	1	4C*1H-0030	1C11H-0030-TC	V4422D-0126	22	7C*22P-0030	3/8
1-27/32	1.8438	46.83	15/16	21/64	V4401D-0127	1	4C*1H-0030	1C11H-0030-TC	V4422D-0127	22	7C*22P-0030	3/8
-	1.8504	47.00	15/16	21/64	V4401D-47	1	4C*1H-0030	1C11H-0030-TC	V4422D-47	22	7C*22P-0030	3/8
1-7/8	1.8750	47.63	15/16	21/64	V4401D-0128	1	4C*1H-0030	1C11H-0030-TC	V4422D-0128	22	7C*22P-0030	3/8
-	1.8898	48.00	45/64	21/64	V4401D-48	1	4C*1H-.703	1C11H-.703-TC	V4417D-48	17	7C*17P-.703	1/2
1-29/32	1.9063	48.42	45/64	21/64	V4401D-0129	1	4C*1H-.703	1C11H-.703-TC	V4417D-0129	17	7C*17P-.703	1/2
-	1.9291	49.00	45/64	21/64	V4401D-49	1	4C*1H-.703	1C11H-.703-TC	V4417D-49	17	7C*17P-.703	1/2
1-15/16	1.9375	49.21	45/64	21/64	V4401D-0130	1	4C*1H-.703	1C11H-.703-TC	V4417D-0130	17	7C*17P-.703	1/2
-	1.9685	50.00	47/64	21/64	V4401D-50	1	4C*1H-.734	1C11H-.734-TC	V4418D-50	18	7C*18P-.734	1/2
1-31/32	1.9688	50.01	47/64	21/64	V4401D-0131	1	4C*1H-.734	1C11H-.734-TC	V4418D-0131	18	7C*18P-.734	1/2
2	2.0000	50.80	47/64	21/64	V4401D-0200	1	4C*1H-.734	1C11H-.734-TC	V4418D-0200	18	7C*18P-.734	1/2

\*Denotes carbide grade (1 = C1, 2 = C2)

IC Inserts

Coating	Size	Grade	Geometry	Part No.	Insert Screw	Insert Driver	Admissible Tightening Torque*
AM300®	3/8	C5 (P35)	Standard	OP-060408-PW	73595-IP15-1	8IP-15	41.0 in-lbs (465 N-cm)
AM300®	3/8	C1 (K35)	Standard	OP-060408-1PW	73595-IP15-1	8IP-15	41.0 in-lbs (465 N-cm)
AM300®	3/8	C2 (K25)	Standard	OP-060408-2PW	73595-IP15-1	8IP-15	41.0 in-lbs (465 N-cm)
AM300®	3/8	C5 (P35)	High Rake	OP-060408-PWHR	73595-IP15-1	8IP-15	41.0 in-lbs (465 N-cm)
AM300®	1/2	C5 (P35)	Standard	OP-080508-PW	74012-IP15-1	8IP-15	61.0 in-lbs (690 N-cm)
AM300®	1/2	C1 (K35)	Standard	OP-080508-1PW	74012-IP15-1	8IP-15	61.0 in-lbs (690 N-cm)
AM300®	1/2	C2 (K25)	Standard	OP-080508-2PW	74012-IP15-1	8IP-15	61.0 in-lbs (690 N-cm)
AM300®	1/2	C5 (P35)	High Rake	OP-080508-PWHR	74012-IP15-1	8IP-15	61.0 in-lbs (690 N-cm)

\*Tightening torques are calculated with a friction coefficient of  $\mu = 0.14$  and develop 90% of ultimate yield strength

Pilot Accessories

Pilot Style	Series	Insert Screws	Insert Driver	Admissible Tightening Torque*
T-A	1	7375-IP9-1	8IP-9	27.0 in-lbs (305 N-cm)
GEN3SYS	17	72567-IP8-1	8IP-8	15.5 in-lbs (175 N-cm)
GEN3SYS	18	7375-IP9-1	8IP-9	27.0 in-lbs (305 N-cm)
GEN3SYS	22	739-IP9-1	8IP-9	27.0 in-lbs (305 N-cm)

\*Tightening torques are calculated with a friction coefficient of  $\mu = 0.14$  and develop 90% of ultimate yield strength

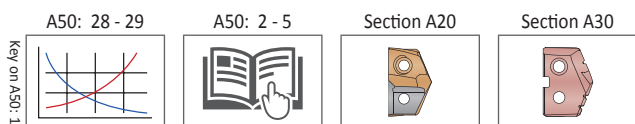

Non-stocked diameters are also available. Follow the examples shown below.

Inch	38 series, T-A (1 series), 1.6790"	Part No. = V3801D-1.6790
Metric	38 series, T-A (1 series), 42.15mm	Part No. = V3801D-42.15

IC inserts sold in multiples of 2 | Insert screws sold in multiples of 10



## APX Drill Holders

44 Series | Diameter Range: 1.7323" - 2.0078" (44.00mm - 50.99mm)

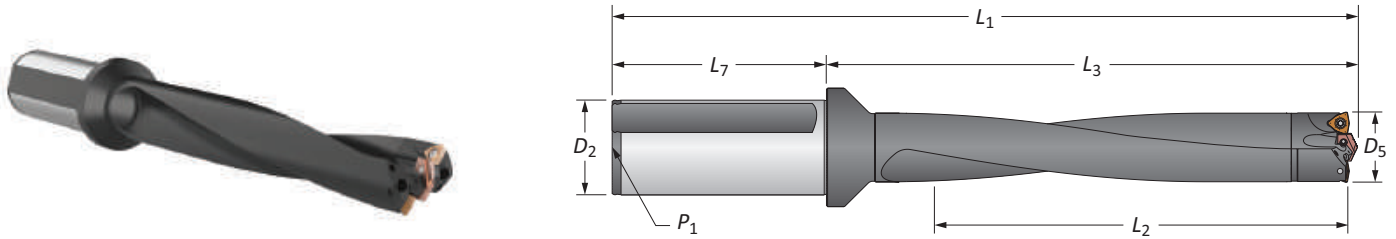

### Straight Shank

Length	D <sub>5</sub>	Body			Shank			Part No.	
		L <sub>2</sub>	L <sub>3</sub>	L <sub>1</sub>	L <sub>7</sub>	D <sub>2</sub>	P <sub>1</sub>		
i	3xD	1.7323 - 2.0078	6	8-17/32	11-15/64	2-11/16	1-1/2	1/4	W4403H-150F
	5xD	1.7323 - 2.0078	10	12-35/64	15-1/4	2-11/16	1-1/2	1/4	W4405H-150F
	8xD	1.7323 - 2.0078	16	18-37/64	21-17/64	2-11/16	1-1/2	1/4	W4408H-150F
	10xD	1.7323 - 2.0078	20-1/8	22-19/32	25-9/32	2-11/16	1-1/2	1/4	W4410H-150F
	3xD	1.7323 - 2.0078	6	8-33/64	13-1/32	4-1/2	2	1/4	W4403H-200F
	5xD	1.7323 - 2.0078	10	12-35/64	17-3/64	4-1/2	2	1/4	W4405H-200F
	8xD	1.7323 - 2.0078	16	18-37/64	23-5/64	4-1/2	2	1/4	W4408H-200F
	10xD	1.7323 - 2.0078	20-1/8	22-19/32	27-3/32	4-1/2	2	1/4	W4410H-200F
m	3xD	44.00 - 50.99	151.5	216.8	286.9	70.0	40.0	1/4*	W4403H-40FM
	5xD	44.00 - 50.99	255.0	318.8	388.9	70.0	40.0	1/4*	W4405H-40FM
	8xD	44.00 - 50.99	407.9	471.8	541.8	70.0	40.0	1/4*	W4408H-40FM
	10xD	44.00 - 50.99	510.0	573.8	643.8	70.0	40.0	1/4*	W4410H-40FM
	3xD	44.00 - 50.99	151.5	216.8	296.9	80.0	50.0	1/4*	W4403H-50FM
	5xD	44.00 - 50.99	255.0	318.8	398.8	80.0	50.0	1/4*	W4405H-50FM
	8xD	44.00 - 50.99	407.9	471.8	551.7	80.0	50.0	1/4*	W4408H-50FM
	10xD	44.00 - 50.99	510.0	573.8	653.8	80.0	50.0	1/4*	W4410H-50FM

\*Thread to BSP and ISO 7-1

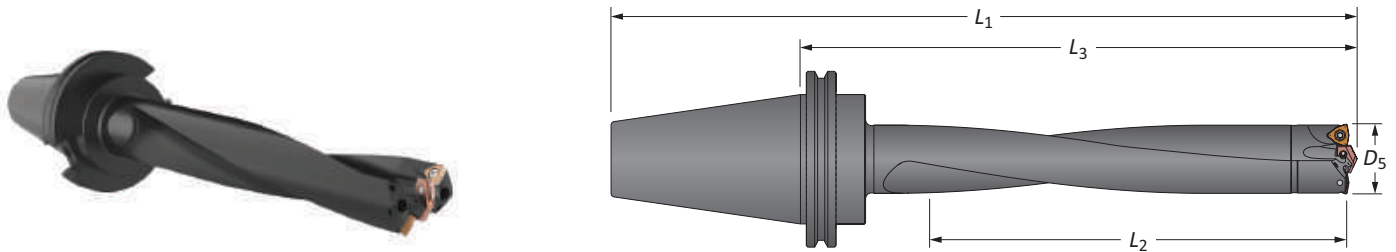

### CAT Integral Shank

Length	D <sub>5</sub>		Body			Shank	Part No.	
	inch	mm	L <sub>2</sub>	L <sub>3</sub>	L <sub>1</sub>			
i	3xD	1.7323 - 2.0078	44.00 - 50.99	6	9-1/4	11-15/16	CV40	W4403H-CV40
	5xD	1.7323 - 2.0078	44.00 - 50.99	10	13-17/64	15-61/64	CV40	W4405H-CV40
	8xD	1.7323 - 2.0078	44.00 - 50.99	16	19-19/64	21-63/64	CV40	W4408H-CV40
	10xD	1.7323 - 2.0078	44.00 - 50.99	20-1/8	23-5/16	26	CV40	W4410H-CV40
	3xD	1.7323 - 2.0078	44.00 - 50.99	6	9-1/4	13-1/4	CV50	W4403H-CV50
	5xD	1.7323 - 2.0078	44.00 - 50.99	10	13-17/64	17-17/64	CV50	W4405H-CV50
	8xD	1.7323 - 2.0078	44.00 - 50.99	16	19-19/64	23-19/64	CV50	W4408H-CV50
	10xD	1.7323 - 2.0078	44.00 - 50.99	20	23-5/16	27-5/16	CV50	W4410H-CV50

### Connection Accessories

		Admissible Tightening Torque*
75020-IP20-1	8IP-20	

\*Tightening torques are calculated with a friction coefficient of  $\mu = 0.14$  and develop 90% of ultimate yield strength

**WARNING** Refer to Speed and Feed charts for recommended adjustments to speeds and feeds. Refer to page A50: 30 for deep hole drilling guidelines in this section of the catalog. Visit [www.alliedmachine.com/DeepHoleGuidelines](http://www.alliedmachine.com/DeepHoleGuidelines) for the most up-to-date information and procedures. Factory technical assistance is available for your specific applications through our Application Engineering Team.

i = Imperial (in)  
m = Metric (mm)



Mounting screws sold in multiples of 4

APX Drill Heads

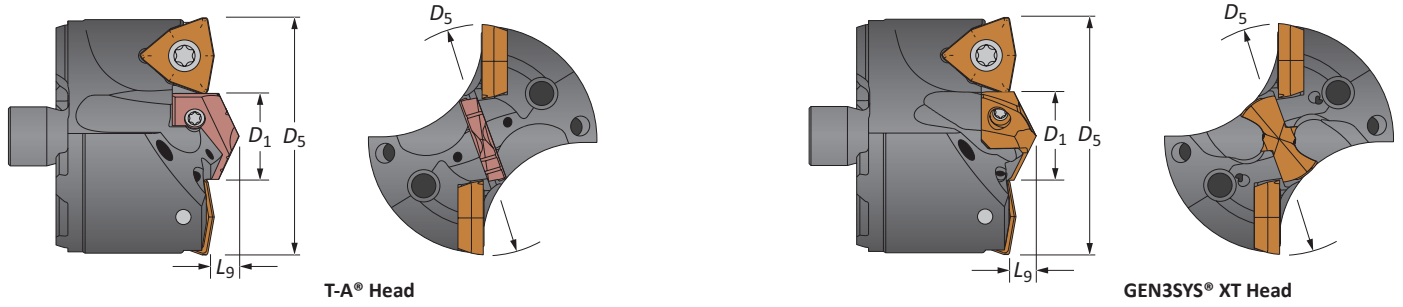
51 Series | Diameter Range: 2.0079" - 2.2440" (51.00mm - 56.99mm)





Heads

Head					T-A Head				GEN3SYS XT Head			IC Insert Size
D <sub>5</sub> fractional	D <sub>5</sub> inch	D <sub>5</sub> mm	D <sub>1</sub>	L <sub>9</sub>	Part No.	Pilot Series	 GEN2 T-A Insert	 T-A (-TC) Insert	Part No.	Pilot Series	 Pilot Insert	
-	2.0079	51.00	25/32	11/32	V5101D-51	1	4C*1H-0025	1C11H-0025-TC	V5118D-51	18	7C*18P-0025	1/2
2-1/32	2.0313	51.59	25/32	11/32	V5101D-0201	1	4C*1H-0025	1C11H-0025-TC	V5118D-0201	18	7C*18P-0025	1/2
-	2.0472	52.00	25/32	11/32	V5101D-52	1	4C*1H-0025	1C11H-0025-TC	V5118D-52	18	7C*18P-0025	1/2
2-1/16	2.0625	52.39	25/32	11/32	V5101D-0202	1	4C*1H-0025	1C11H-0025-TC	V5118D-0202	18	7C*18P-0025	1/2
-	2.0866	53.00	27/32	11/32	V5101D-53	1	4C*1H-0027	1C11H-0027-TC	V5120D-53	20	7C*20P-0027	1/2
2-3/32	2.0938	53.18	27/32	11/32	V5101D-0203	1	4C*1H-0027	1C11H-0027-TC	V5120D-0203	20	7C*20P-0027	1/2
2-1/8	2.1250	53.98	27/32	11/32	V5101D-0204	1	4C*1H-0027	1C11H-0027-TC	V5120D-0204	20	7C*20P-0027	1/2
-	2.1260	54.00	15/16	11/32	V5101D-54	1	4C*1H-0030	1C11H-0030-TC	V5122D-54	22	7C*22P-0030	1/2
2-5/32	2.1563	54.77	15/16	11/32	V5101D-0205	1	4C*1H-0030	1C11H-0030-TC	V5122D-0205	22	7C*22P-0030	1/2
-	2.1654	55.00	15/16	11/32	V5101D-55	1	4C*1H-0030	1C11H-0030-TC	V5122D-55	22	7C*22P-0030	1/2
2-3/16	2.1875	55.56	15/16	11/32	V5101D-0206	1	4C*1H-0030	1C11H-0030-TC	V5122D-0206	22	7C*22P-0030	1/2
-	2.2047	56.00	15/16	11/32	V5101D-56	1	4C*1H-0030	1C11H-0030-TC	V5122D-56	22	7C*22P-0030	1/2
2-7/32	2.2188	56.36	13/16	11/32	V5101D-0207	1	4C*1H-0026	1C11H-0026-TC	V5120D-0207	20	7C*20P-0026	9/16



\*Denotes carbide grade (1 = C1, 2 = C2)

IC Inserts

Coating	Size	Grade	Geometry	 Part No.	 Insert Screw	 Insert Driver	Admissible Tightening Torque*
AM300®	1/2	C5 (P35)	Standard	OP-080508-PW	74012-IP15-1	8IP-15	61.0 in-lbs (690 N-cm)
AM300®	1/2	C1 (K35)	Standard	OP-080508-1PW	74012-IP15-1	8IP-15	61.0 in-lbs (690 N-cm)
AM300®	1/2	C2 (K25)	Standard	OP-080508-2PW	74012-IP15-1	8IP-15	61.0 in-lbs (690 N-cm)
AM300®	1/2	C5 (P35)	High Rake	OP-080508-PWHR	74012-IP15-1	8IP-15	61.0 in-lbs (690 N-cm)
AM300®	9/16	C5 (P35)	Standard	OP-090608-PW	75014-IP20-1	8IP-20	121.0 in-lbs (1370 N-cm)
AM300®	9/16	C1 (K35)	Standard	OP-090608-1PW	75014-IP20-1	8IP-20	121.0 in-lbs (1370 N-cm)
AM300®	9/16	C2 (K25)	Standard	OP-090608-2PW	75014-IP20-1	8IP-20	121.0 in-lbs (1370 N-cm)
AM300®	9/16	C5 (P35)	High Rake	OP-090608-PWHR	75014-IP20-1	8IP-20	121.0 in-lbs (1370 N-cm)

\*Tightening torques are calculated with a friction coefficient of  $\mu = 0.14$  and develop 90% of ultimate yield strength

Pilot Accessories

Pilot Style	Series	 Insert Screws	 Insert Driver	Admissible Tightening Torque*
T-A	1	7375-IP9-1	8IP-9	27.0 in-lbs (305 N-cm)
GEN3SYS	18	7375-IP9-1	8IP-9	27.0 in-lbs (305 N-cm)
GEN3SYS	20	7375-IP9-1	8IP-9	27.0 in-lbs (305 N-cm)
GEN3SYS	22	739-IP9-1	8IP-9	27.0 in-lbs (305 N-cm)

\*Tightening torques are calculated with a friction coefficient of  $\mu = 0.14$  and develop 90% of ultimate yield strength

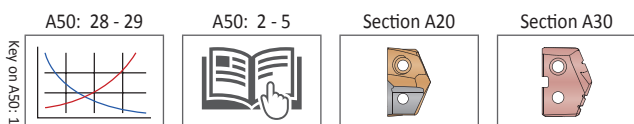

Non-stocked diameters are also available. Follow the examples shown below.

Inch	38 series, T-A (1 series), 1.6790"	Part No. = V3801D-1.6790
Metric	38 series, T-A (1 series), 42.15mm	Part No. = V3801D-42.15

IC inserts sold in multiples of 2 | Insert screws sold in multiples of 10

A DRILLING  
B BORING  
C REAMING  
D BURNISHING  
E THREADING  
X SPECIALS



## APX Drill Holders

51 Series | Diameter Range: 2.0079" - 2.2440" (51.00mm - 56.99mm)

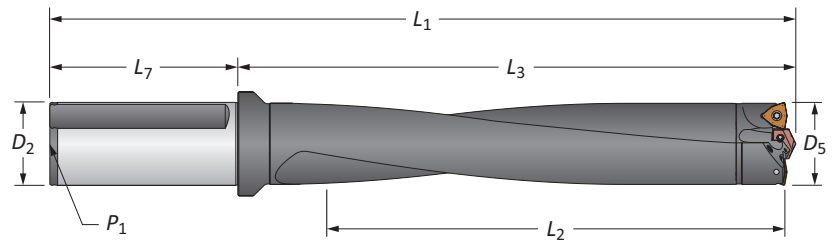

### Straight Shank

	Length	D <sub>5</sub>	Body			Shank			Part No.
			L <sub>2</sub>	L <sub>3</sub>	L <sub>1</sub>	L <sub>7</sub>	D <sub>2</sub>	P <sub>1</sub>	
i	3xD	2.0079 - 2.2438	6-3/8	8-7/8	13-3/8	4-1/2	2	1/4	W5103H-200F
	5xD	2.0079 - 2.2438	11-1/8	13-3/8	17-7/8	4-1/2	2	1/4	W5105H-200F
	8xD	2.0079 - 2.2438	17-7/8	20-3/32	24-19/32	4-1/2	2	1/4	⚠ W5108H-200F
	10xD	2.0079 - 2.2438	22-3/8	24-19/32	29-3/32	4-1/2	2	1/4	⚠ W5110H-200F
m	3xD	51.00 - 56.99	161.8	225.5	305.5	80.0	50.0	1/4*	W5103H-50FM
	5xD	51.00 - 56.99	285.0	339.6	419.6	80.0	50.0	1/4*	W5105H-50FM
	8xD	51.00 - 56.99	455.9	510.5	590.5	80.0	50.0	1/4*	⚠ W5108H-50FM
	10xD	51.00 - 56.99	570.0	624.6	704.6	80.0	50.0	1/4*	⚠ W5110H-50FM

\*Thread to BSP and ISO 7-1

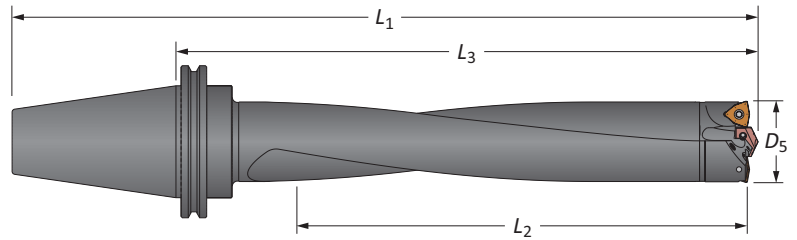

### CV50 Shank

	Length	D <sub>5</sub>		Body			Shank	Part No.
		inch	mm	L <sub>2</sub>	L <sub>3</sub>	L <sub>1</sub>		
i	3xD	2.0079 - 2.2440	51.00 - 56.99	6-3/8	9-47/64	13-47/64	CV50	W5103H-CV50
	5xD	2.0079 - 2.2440	51.00 - 56.99	11-1/4	14-7/32	18-7/32	CV50	W5105H-CV50
	8xD	2.0079 - 2.2440	51.00 - 56.99	17-7/8	20-61/64	24-61/64	CV50	⚠ W5108H-CV50
	10xD	2.0079 - 2.2440	51.00 - 56.99	22-3/8	25-7/16	29-7/16	CV50	⚠ W5110H-CV50

### Connection Accessories

Mounting Screw	Mounting Screw Driver	Admissible Tightening Torque*
75020-IP20-1	8IP-20	60 in-lb (678 N-cm)

\*Tightening torques are calculated with a friction coefficient of  $\mu = 0.14$  and develop 90% of ultimate yield strength

**⚠ WARNING** Refer to Speed and Feed charts for recommended adjustments to speeds and feeds. Refer to page A50: 30 for deep hole drilling guidelines in this section of the catalog. Visit [www.alliedmachine.com/DeepHoleGuidelines](http://www.alliedmachine.com/DeepHoleGuidelines) for the most up-to-date information and procedures. Factory technical assistance is available for your specific applications through our Application Engineering Team.

i = Imperial (in)  
m = Metric (mm)

Mounting screws sold in multiples of 4

APX Drill Heads

57 Series | Diameter Range: 2.2441" - 2.4802" (57.00mm - 62.99mm)

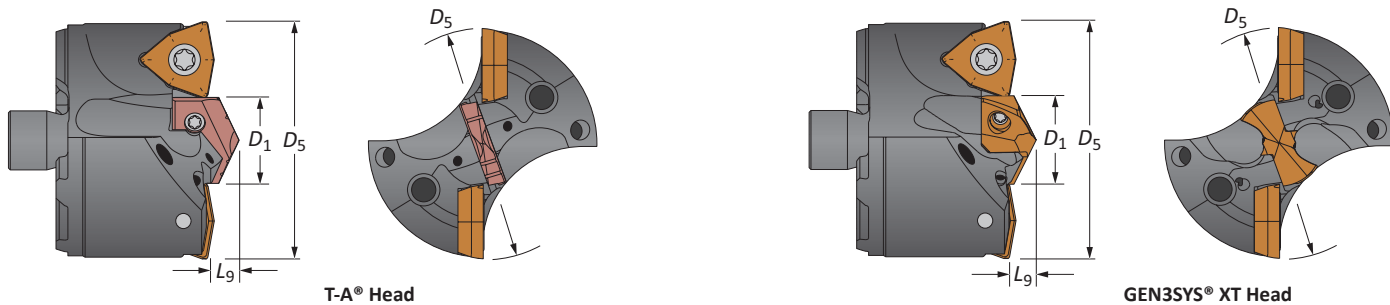

Heads

Head					T-A Head				GEN3SYS XT Head			
D <sub>5</sub> fractional	D <sub>5</sub> inch	D <sub>5</sub> mm	D <sub>1</sub>	L <sub>9</sub>	Part No.	Pilot Series	GEN2 T-A Insert	T-A (-TC) Insert	Part No.	Pilot Series	Pilot Insert	IC Insert Size
-	2.2441	57.00	29/32	25/64	V5701D-57	1	4C*1H-0029	1C11H-0029-TC	V5722D-57	22	7C*22P-0029	9/16
2-1/4	2.2500	57.15	29/32	25/64	V5701D-0208	1	4C*1H-0029	1C11H-0029-TC	V5722D-0208	22	7C*22P-0029	9/16
2-9/32	2.2813	57.94	29/32	25/64	V5701D-0209	1	4C*1H-0029	1C11H-0029-TC	V5722D-0209	22	7C*22P-0029	9/16
-	2.2835	58.00	29/32	25/64	V5701D-58	1	4C*1H-0029	1C11H-0029-TC	V5722D-58	22	7C*22P-0029	9/16
2-5/16	2.3125	58.74	29/32	25/64	V5701D-0210	1	4C*1H-0029	1C11H-0029-TC	V5722D-0210	22	7C*22P-0029	9/16
-	2.3228	59.00	15/16	25/64	V5701D-59	1	4C*1H-0030	1C11H-0030-TC	V5722D-59	22	7C*22P-0030	9/16
2-11/32	2.3438	59.53	15/16	25/64	V5701D-0211	1	4C*1H-0030	1C11H-0030-TC	V5722D-0211	22	7C*22P-0030	9/16
-	2.3622	60.00	15/16	25/64	V5701D-60	1	4C*1H-0030	1C11H-0030-TC	V5722D-60	22	7C*22P-0030	9/16
2-3/8	2.3750	60.33	15/16	25/64	V5701D-0212	1	4C*1H-0030	1C11H-0030-TC	V5722D-0212	22	7C*22P-0030	9/16
-	2.4016	61.00	1	25/64	V5702D-61	2	4C*2H-0100	1C12H-0100-TC	V5724D-61	24	7C*24P-0100	9/16
2-13/32	2.4063	61.12	1	25/64	V5702D-0213	2	4C*2H-0100	1C12H-0100-TC	V5724D-0213	24	7C*24P-0100	9/16
2-7/16	2.4375	61.91	1	25/64	V5702D-0214	2	4C*2H-0100	1C12H-0100-TC	V5724D-0214	24	7C*24P-0100	9/16
-	2.4409	62.00	1-1/16	25/64	V5702D-62	2	4C*2H-0102	1C12H-0102-TC	V5726D-62	26	7C*26P-0102	9/16
2-15/32	2.4688	62.71	1-1/16	25/64	V5702D-0215	2	4C*2H-0102	1C12H-0102-TC	V5726D-0215	26	7C*26P-0102	9/16

\*Denotes carbide grade (1 = C1, 2 = C2)

IC Inserts

Coating	Size	Grade	Geometry	Part No.	Insert Screw	Insert Driver	Admissible Tightening Torque*
AM300®	9/16	C5 (P35)	Standard	OP-090608-PW	75014-IP20-1	8IP-20	121.0 in-lbs (1370 N-cm)
AM300®	9/16	C1 (K35)	Standard	OP-090608-1PW	75014-IP20-1	8IP-20	121.0 in-lbs (1370 N-cm)
AM300®	9/16	C2 (K25)	Standard	OP-090608-2PW	75014-IP20-1	8IP-20	121.0 in-lbs (1370 N-cm)
AM300®	9/16	C5 (P35)	High Rake	OP-090608-PWHR	75014-IP20-1	8IP-20	121.0 in-lbs (1370 N-cm)

\*Tightening torques are calculated with a friction coefficient of  $\mu = 0.14$  and develop 90% of ultimate yield strength

Pilot Accessories

Pilot Style	Series	Insert Screws	Insert Driver	Admissible Tightening Torque*
T-A	1	7375-IP9-1	8IP-9	27.0 in-lbs (305 N-cm)
T-A	2	7495-IP15-1	8IP-15	61.0 in-lbs (690 N-cm)
GEN3SYS	22	739-IP9-1	8IP-9	27.0 in-lbs (305 N-cm)
GEN3SYS	24	739-IP9-1	8IP-9	27.0 in-lbs (305 N-cm)
GEN3SYS	26	7495-IP15-1	8IP-15	61.0 in-lbs (690 N-cm)

\*Tightening torques are calculated with a friction coefficient of  $\mu = 0.14$  and develop 90% of ultimate yield strength

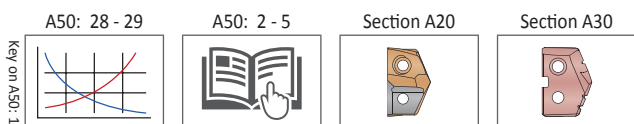

Non-stocked diameters are also available. Follow the examples shown below.

Inch	38 series, T-A (1 series), 1.6790"	Part No. = V3801D-1.6790
Metric	38 series, T-A (1 series), 42.15mm	Part No. = V3801D-42.15

IC inserts sold in multiples of 2 | Insert screws sold in multiples of 10

A DRILLING  
B BORING  
C REAMING  
D BURNISHING  
E THREADING  
X SPECIALS

## APX Drill Holders

57 Series | Diameter Range: 2.2441" - 2.4802" (57.00mm - 62.99mm)

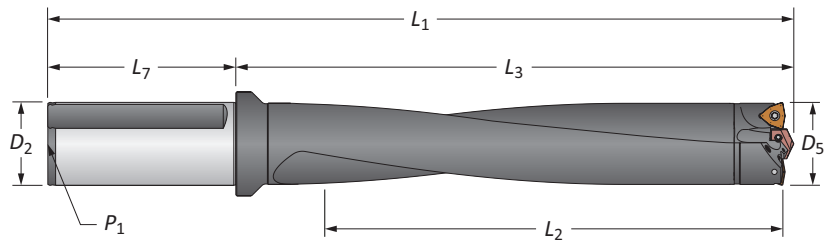

### Straight Shank

	Length	D <sub>5</sub>	Body			Shank			Part No.
			L <sub>2</sub>	L <sub>3</sub>	L <sub>1</sub>	L <sub>7</sub>	D <sub>2</sub>	P <sub>1</sub>	
i	3xD	2.2441 - 2.4802	7-1/8	9-35/64	14-1/16	4-1/2	2	1/4	W5703H-200F
	5xD	2.2441 - 2.4802	12-3/8	14-33/64	19-1/64	4-1/2	2	1/4	W5705H-200F
	8xD	2.2441 - 2.4802	19-3/4	21-31/32	26-15/32	4-1/2	2	1/4	W5708H-200F
	10xD	2.2441 - 2.4802	24-3/4	26-59/64	31-27/64	4-1/2	2	1/4	W5710H-200F
m	3xD	57.00 - 62.99	179.9	242.7	322.7	80.0	50.0	1/4*	W5703H-50FM
	5xD	57.00 - 62.99	315.0	368.6	448.6	80.0	50.0	1/4*	W5705H-50FM
	8xD	57.00 - 62.99	503.9	557.8	637.8	80.0	50.0	1/4*	W5708H-50FM
	10xD	57.00 - 62.99	626.9	683.8	763.8	80.0	50.0	1/4*	W5710H-50FM

\*Thread to BSP and ISO 7-1

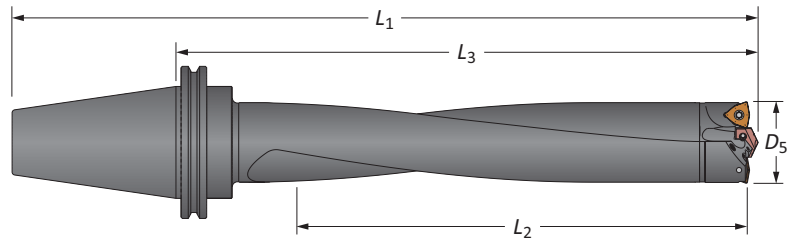

### CV50 Shank

	Length	D <sub>5</sub>		Body			Shank	Part No.
		inch	mm	L <sub>2</sub>	L <sub>3</sub>	L <sub>1</sub>		
i	3xD	2.2441 - 2.4802	57.00 - 62.99	7-1/8	10-17/32	14-17/32	CV50	W5703H-CV50
	5xD	2.2441 - 2.4802	57.00 - 62.99	12-3/8	15-31/64	19-31/64	CV50	W5705H-CV50
	8xD	2.2441 - 2.4802	57.00 - 62.99	19-7/8	22-15/16	26-15/16	CV50	W5708H-CV50
	10xD	2.2441 - 2.4802	57.00 - 62.99	24-3/4	27-57/64	31-57/64	CV50	W5710H-CV50

### Connection Accessories

Mounting Screw	Mounting Screw Driver	Admissible Tightening Torque*
75020-IP20-1	8IP-20	60 in-lb (678 N-cm)

\*Tightening torques are calculated with a friction coefficient of  $\mu = 0.14$  and develop 90% of ultimate yield strength

**⚠ WARNING** Refer to Speed and Feed charts for recommended adjustments to speeds and feeds. Refer to page A50: 30 for deep hole drilling guidelines in this section of the catalog. Visit [www.alliedmachine.com/DeepHoleGuidelines](http://www.alliedmachine.com/DeepHoleGuidelines) for the most up-to-date information and procedures. Factory technical assistance is available for your specific applications through our Application Engineering Team.

i = Imperial (in)  
m = Metric (mm)

Mounting screws sold in multiples of 4

APX Drill Heads

63 Series | Diameter Range: 2.4803" - 2.7558" (63.00mm - 69.99mm)

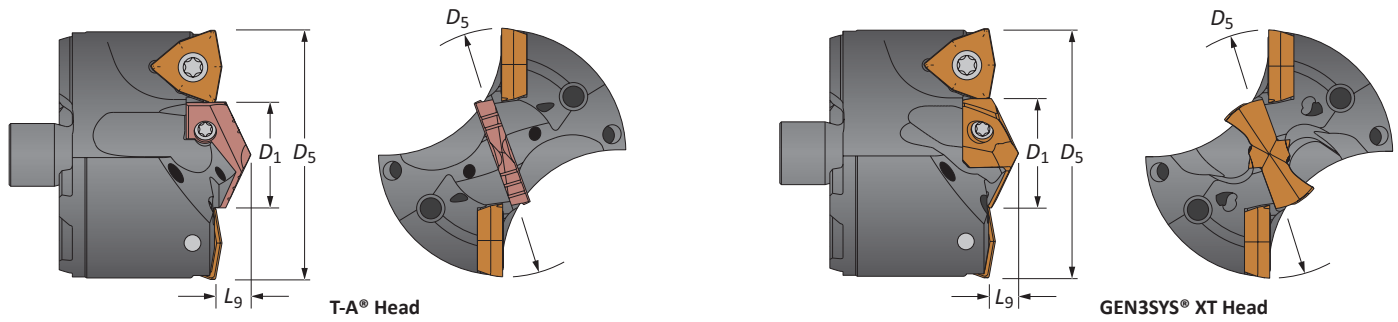

Heads

Head					T-A Head				GEN3SYS XT Head			
D <sub>5</sub> fractional	D <sub>5</sub> inch	D <sub>5</sub> mm	D <sub>1</sub>	L <sub>9</sub>	Part No.	Pilot Series	GEN2 T-A Insert	T-A (-TC) Insert	Part No.	Pilot Series	Pilot Insert	IC Insert Size
-	2.4803	63.00	1-1/8	7/16	V6302D-63	2	4C*2H-0104	1C12H-0104-TC	V6326D-63	26	7C*26P-0104	9/16
2-1/2	2.5000	63.50	1-1/8	7/16	V6302D-0216	2	4C*2H-0104	1C12H-0104-TC	V6326D-0216	26	7C*26P-0104	9/16
-	2.5197	64.00	1-1/8	7/16	V6302D-64	2	4C*2H-0104	1C12H-0104-TC	V6326D-64	26	7C*26P-0104	9/16
2-17/32	2.5313	64.29	1-1/8	7/16	V6302D-0217	2	4C*2H-0104	1C12H-0104-TC	V6326D-0217	26	7C*26P-0104	9/16
-	2.5591	65.00	1-1/8	7/16	V6302D-65	2	4C*2H-0104	1C12H-0104-TC	V6326D-65	26	7C*26P-0104	9/16
2-9/16	2.5625	65.09	1-3/16	7/16	V6302D-0218	2	4C*2H-0106	1C12H-0106-TC	V6329D-0218	29	7C*29P-0106	9/16
2-19/32	2.5938	65.88	1-3/16	7/16	V6302D-0219	2	4C*2H-0106	1C12H-0106-TC	V6329D-0219	29	7C*29P-0106	9/16
-	2.5984	66.00	1-3/16	7/16	V6302D-66	2	4C*2H-0106	1C12H-0106-TC	V6329D-66	29	7C*29P-0106	9/16
2-5/8	2.6250	66.68	1-3/16	7/16	V6302D-0220	2	4C*2H-0106	1C12H-0106-TC	V6329D-0220	29	7C*29P-0106	9/16
-	2.6378	67.00	1-1/4	7/16	V6302D-67	2	4C*2H-0108	1C12H-0108-TC	V6329D-67	29	7C*29P-0108	9/16
2-21/32	2.6563	67.47	1-1/4	7/16	V6302D-0221	2	4C*2H-0108	1C12H-0108-TC	V6329D-0221	29	7C*29P-0108	9/16
-	2.6772	68.00	1-1/4	7/16	V6302D-68	2	4C*2H-0108	1C12H-0108-TC	V6329D-68	29	7C*29P-0108	9/16
2-11/16	2.6875	68.26	1-1/4	7/16	V6302D-0222	2	4C*2H-0108	1C12H-0108-TC	V6329D-0222	29	7C*29P-0108	9/16
-	2.7165	69.00	1-5/16	7/16	V6302D-69	2	4C*2H-0110	1C12H-0110-TC	V6332D-69	32	7C*32P-0110	9/16
2-23/32	2.7188	69.06	1-5/16	7/16	V6302D-0223	2	4C*2H-0110	1C12H-0110-TC	V6332D-0223	32	7C*32P-0110	9/16
2-3/4	2.7500	69.85	1-5/16	7/16	V6302D-0224	2	4C*2H-0110	1C12H-0110-TC	V6332D-0224	32	7C*32P-0110	9/16

\*Denotes carbide grade (1 = C1, 2 = C2)

IC Inserts

Coating	Size	Grade	Geometry	Part No.	Insert Screw	Insert Driver	Admissible Tightening Torque*
AM300®	9/16	C5 (P35)	Standard	OP-090608-PW	75014-IP20-1	8IP-20	121.0 in-lbs (1370 N-cm)
AM300®	9/16	C1 (K35)	Standard	OP-090608-1PW	75014-IP20-1	8IP-20	121.0 in-lbs (1370 N-cm)
AM300®	9/16	C2 (K25)	Standard	OP-090608-2PW	75014-IP20-1	8IP-20	121.0 in-lbs (1370 N-cm)
AM300®	9/16	C5 (P35)	High Rake	OP-090608-PWHR	75014-IP20-1	8IP-20	121.0 in-lbs (1370 N-cm)

\*Tightening torques are calculated with a friction coefficient of  $\mu = 0.14$  and develop 90% of ultimate yield strength

Pilot Accessories

Pilot Style	Series	Insert Screws	Insert Driver	Admissible Tightening Torque*
T-A	2	7495-IP15-1	8IP-15	61.0 in-lbs (690 N-cm)
GEN3SYS	26	7495-IP15-1	8IP-15	61.0 in-lbs (690 N-cm)
GEN3SYS	29	7495-IP15-1	8IP-15	61.0 in-lbs (690 N-cm)
GEN3SYS	32	7495-IP15-1	8IP-15	61.0 in-lbs (690 N-cm)

\*Tightening torques are calculated with a friction coefficient of  $\mu = 0.14$  and develop 90% of ultimate yield strength

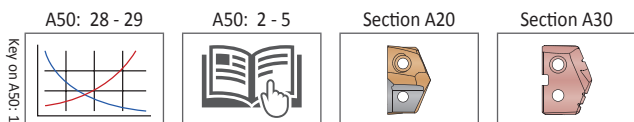

Non-stocked diameters are also available. Follow the examples shown below.

Inch	38 series, T-A (1 series), 1.6790"	Part No. = V3801D-1.6790
Metric	38 series, T-A (1 series), 42.15mm	Part No. = V3801D-42.15

IC inserts sold in multiples of 2 | Insert screws sold in multiples of 10

A DRILLING  
B BORING  
C REAMING  
D BURNISHING  
E THREADING  
X SPECIALS



## APX Drill Holders

63 Series | Diameter Range: 2.4803" - 2.7558" (63.00mm - 69.99mm)

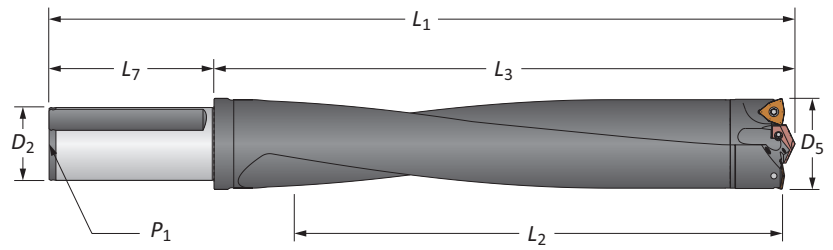

### Straight Shank

	Length	D <sub>5</sub>	Body			Shank			Part No.
			L <sub>2</sub>	L <sub>3</sub>	L <sub>1</sub>	L <sub>7</sub>	D <sub>2</sub>	P <sub>1</sub>	
i	3xD	2.4803 - 2.7558	7-7/8	10-11/32	14-27/32	4-1/2	2	1/4	W6303H-200F
	5xD	2.4803 - 2.7558	13-3/4	15-27/32	20-11/32	4-1/2	2	1/4	W6305H-200F
	8xD	2.4803 - 2.7558	22-1/8	24-1/8	28-5/8	4-1/2	2	1/4	⚠ W6308H-200F
	10xD	2.4803 - 2.7558	27-1/8	29-11/64	33-43/64	4-1/2	2	1/4	⚠ W6310H-200F
m	3xD	63.00 - 69.99	200.8	262.6	342.6	80.0	50.0	1/4*	W6303H-50FM
	5xD	63.00 - 69.99	350.0	402.6	482.6	80.0	50.0	1/4*	W6305H-50FM
	8xD	63.00 - 69.99	560.0	612.6	692.6	80.0	50.0	1/4*	⚠ W6308H-50FM
	10xD	63.00 - 69.99	688.3	740.9	820.9	80.0	50.0	1/4*	⚠ W6310H-50FM

\*Thread to BSP and ISO 7-1

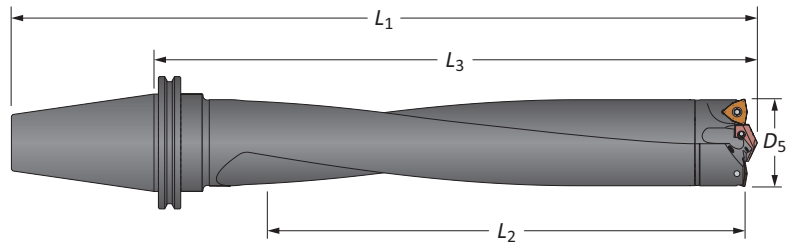

### CV50 Shank

	Length	D <sub>5</sub>		Body			Shank	Part No.
		inch	mm	L <sub>2</sub>	L <sub>3</sub>	L <sub>1</sub>		
i	3xD	2.4803 - 2.7558	63.00 - 69.99	7-7/8	11-7/16	15-7/16	CV50	W6303H-CV50
	5xD	2.4803 - 2.7558	63.00 - 69.99	13-3/4	16-15/16	20-15/16	CV50	W6305H-CV50
	8xD	2.4803 - 2.7558	63.00 - 69.99	22	25-13/64	29-13/64	CV50	⚠ W6308H-CV50
	10xD	2.4803 - 2.7558	63.00 - 69.99	26-1/2	29-43/64	33-43/64	CV50	⚠ W6310H-CV50

### Connection Accessories

Mounting Screw	Mounting Screw Driver	Admissible Tightening Torque*
75020-IP20-1	8IP-20	60 in-lb (678 N-cm)

\*Tightening torques are calculated with a friction coefficient of  $\mu = 0.14$  and develop 90% of ultimate yield strength

**⚠ WARNING** Refer to Speed and Feed charts for recommended adjustments to speeds and feeds. Refer to page A50: 30 for deep hole drilling guidelines in this section of the catalog. Visit [www.alliedmachine.com/DeepHoleGuidelines](http://www.alliedmachine.com/DeepHoleGuidelines) for the most up-to-date information and procedures. Factory technical assistance is available for your specific applications through our Application Engineering Team.

i = Imperial (in)  
m = Metric (mm)



Mounting screws sold in multiples of 4

## APX Drill Heads

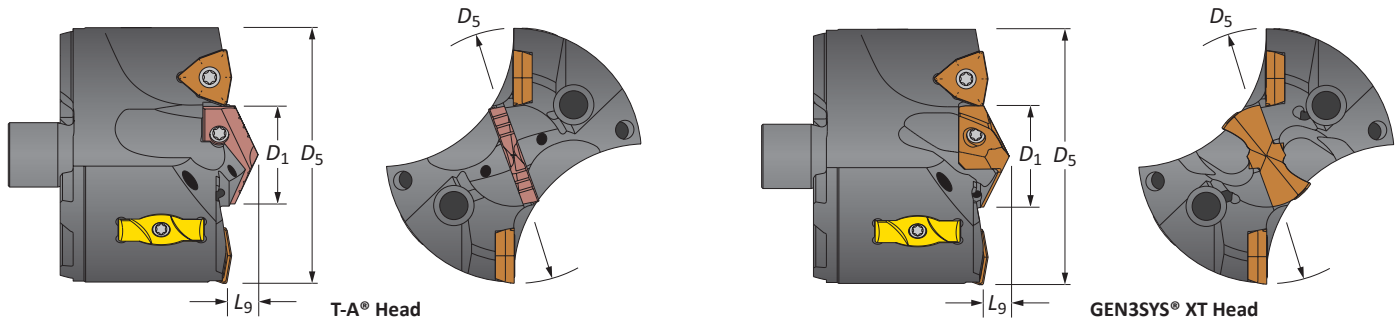
70 Series | Diameter Range: 2.7559" - 2.9920" (70.00mm - 75.99mm)





### Heads

Head					T-A Head				GEN3SYS XT Head			IC Insert Size
$D_5$ fractional	$D_5$ inch	$D_5$ mm	$D_1$	$L_9$	Part No.	Pilot Series			Part No.	Pilot Series		
-	2.7559	70.00	1-7/32	25/64	<b>V7002S-70</b>	2	4C*2H-0107	1C12H-0107-TC	<b>V7029S-70</b>	29	7C*29P-0107	3/8
2-13/16	2.8125	71.44	1-7/32	25/64	<b>V7002S-0226</b>	2	4C*2H-0107	1C12H-0107-TC	<b>V7029S-0226</b>	29	7C*29P-0107	3/8
-	2.8346	72.00	1-7/32	25/64	<b>V7002S-72</b>	2	4C*2H-0107	1C12H-0107-TC	<b>V7029S-72</b>	29	7C*29P-0107	3/8
2-7/8	2.8750	73.03	1-7/32	25/64	<b>V7002S-0228</b>	2	4C*2H-0107	1C12H-0107-TC	<b>V7029S-0228</b>	29	7C*29P-0107	3/8
-	2.9134	74.00	1-7/32	25/64	<b>V7002S-74</b>	2	4C*2H-0107	1C12H-0107-TC	<b>V7029S-74</b>	29	7C*29P-0107	3/8
2-15/16	2.9375	74.61	1-7/32	25/64	<b>V7002S-0230</b>	2	4C*2H-0107	1C12H-0107-TC	<b>V7029S-0230</b>	29	7C*29P-0107	3/8



\*Denotes carbide grade (1 = C1, 2 = C2)

### IC Inserts

Coating	Size	Grade	Geometry	 Part No.	 Insert Screw	 Insert Driver	Admissible Tightening Torque*
AM300®	3/8	C5 (P35)	Standard	<b>OP-060408-PW</b>	73595-IP15-1	8IP-15	41.0 in-lbs (465 N-cm)
AM300®	3/8	C1 (K35)	Standard	<b>OP-060408-1PW</b>	73595-IP15-1	8IP-15	41.0 in-lbs (465 N-cm)
AM300®	3/8	C2 (K25)	Standard	<b>OP-060408-2PW</b>	73595-IP15-1	8IP-15	41.0 in-lbs (465 N-cm)
AM300®	3/8	C5 (P35)	High Rake	<b>OP-060408-PWHR</b>	73595-IP15-1	8IP-15	41.0 in-lbs (465 N-cm)



\*Tightening torques are calculated with a friction coefficient of  $\mu = 0.14$  and develop 90% of ultimate yield strength

### Wear Pads

 Part No.	 Wear Pad Screw	 Wear Pad Driver	Admissible Tightening Torque*
<b>WP7095</b>	7358-IP10-1	8IP-10	27.0 in-lbs (300 N-cm)

\*Tightening torques are calculated with a friction coefficient of  $\mu = 0.14$  and develop 90% of ultimate yield strength

### Pilot Accessories

Pilot Style	Series	 Insert Screws	 Insert Driver	Admissible Tightening Torque*
T-A	2	7495-IP15-1	8IP-15	61.0 in-lbs (690 N-cm)
GEN3SYS	29	7495-IP15-1	8IP-15	61.0 in-lbs (690 N-cm)

\*Tightening torques are calculated with a friction coefficient of  $\mu = 0.14$  and develop 90% of ultimate yield strength



Non-stocked diameters are also available. Follow the examples shown below.

<b>Inch</b>	38 series, T-A (1 series), 1.6790"	Part No. = <b>V3801D-1.6790</b>
<b>Metric</b>	38 series, T-A (1 series), 42.15mm	Part No. = <b>V3801D-42.15</b>

Wear pads sold in multiples of 2 | Wear pad screws sold in multiples of 4  
IC inserts sold in multiples of 2 | Insert screws sold in multiples of 10



## APX Drill Holders

70 Series | Diameter Range: 2.7559" - 2.9920" (70.00mm - 75.99mm)

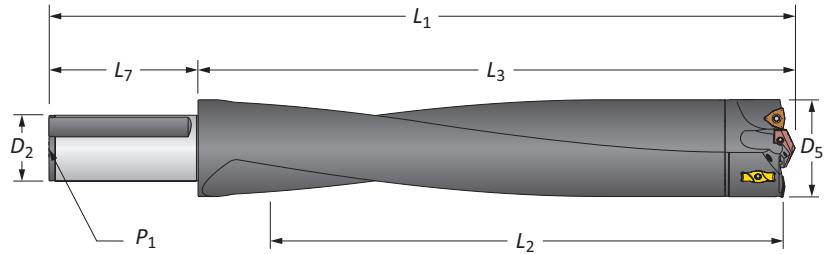

### Straight Shank

	Length	D <sub>5</sub>	Body			Shank			Part No.
			L <sub>2</sub>	L <sub>3</sub>	L <sub>1</sub>	L <sub>7</sub>	D <sub>2</sub>	P <sub>1</sub>	
i	3xD	2.7559 - 2.9920	8-3/4	10-19/32	15-3/32	4-1/2	2	1/4	W7003H-200F
	5xD	2.7559 - 2.9920	14-7/8	16-37/64	21-5/64	4-1/2	2	1/4	W7005H-200F
	8xD	2.7559 - 2.9920	23-7/8	25-35/64	30-3/64	4-1/2	2	1/4	W7008H-200F
	10xD	2.7559 - 2.9920	27-7/8	29-35/64	34-3/64	4-1/2	2	1/4	W7010H-200F
m	3xD	70.00 - 75.99	218.8	269.0	349.0	80.0	50.0	1/4*	W7003H-50FM
	5xD	70.00 - 75.99	380.0	421.1	501.1	80.0	50.0	1/4*	W7005H-50FM
	8xD	70.00 - 75.99	608.0	649.0	729.0	80.0	50.0	1/4*	W7008H-50FM
	10xD	70.00 - 75.99	709.4	750.3	830.3	80.0	50.0	1/4*	W7010H-50FM

\*Thread to BSP and ISO 7-1

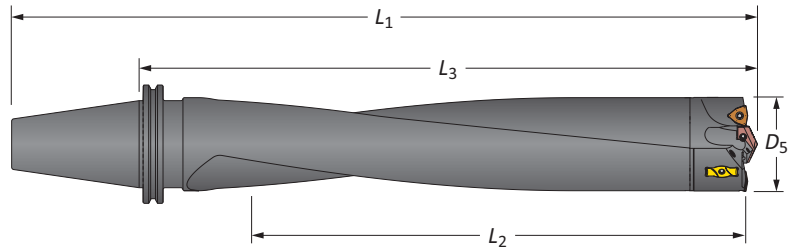

### CV50 Shank

	Length	D <sub>5</sub>		Body			Shank	Part No.
		inch	mm	L <sub>2</sub>	L <sub>3</sub>	L <sub>1</sub>		
i	3xD	2.7559 - 2.9920	70.00 - 75.99	8-3/4	12-7/32	16-7/32	CV50	W7003H-CV50
	5xD	2.7559 - 2.9920	70.00 - 75.99	14-7/8	18-13/64	22-13/64	CV50	W7005H-CV50
	8xD	2.7559 - 2.9920	70.00 - 75.99	23-7/8	27-5/32	31-5/32	CV50	W7008H-CV50
	10xD	2.7559 - 2.9920	70.00 - 75.99	26-3/4	29-61/64	33-61/64	CV50	W7010H-CV50

### Connection Accessories

Mounting Screw	Mounting Screw Bit	Admissible Tightening Torque*
78027-IP30-1	8IP-30B	250 in-lb (2825 N-cm)

\*Tightening torques are calculated with a friction coefficient of  $\mu = 0.14$  and develop 90% of ultimate yield strength

**WARNING** Refer to Speed and Feed charts for recommended adjustments to speeds and feeds. Refer to page A50: 30 for deep hole drilling guidelines in this section of the catalog. Visit [www.alliedmachine.com/DeepHoleGuidelines](http://www.alliedmachine.com/DeepHoleGuidelines) for the most up-to-date information and procedures. Factory technical assistance is available for your specific applications through our Application Engineering Team.

i = Imperial (in)  
m = Metric (mm)



Mounting screws sold in multiples of 4

## APX Drill Heads

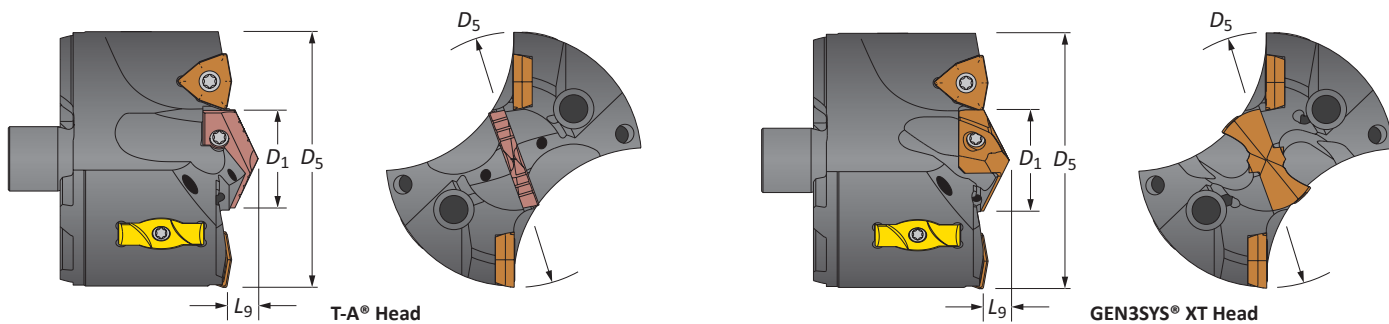
76 Series | Diameter Range: 2.9921" - 3.2676" (76.00mm - 82.99mm)





### Heads

Head					T-A Head				GEN3SYS XT Head			
$D_5$ fractional	$D_5$ inch	$D_5$ mm	$D_1$	$L_9$	Part No.	Pilot Series			Part No.	Pilot Series		IC Insert Size
-	2.9921	76.00	1-7/32	13/32	<b>V7602S-76</b>	2	4C*2H-0107	1C12H-0107-TC	<b>V7629S-76</b>	29	7C*29P-0107	1/2
3	3.0000	76.20	1-7/32	13/32	<b>V7602S-0300</b>	2	4C*2H-0107	1C12H-0107-TC	<b>V7629S-0300</b>	29	7C*29P-0107	1/2
3-1/16	3.0625	77.79	1-7/32	13/32	<b>V7602S-0302</b>	2	4C*2H-0107	1C12H-0107-TC	<b>V7629S-0302</b>	29	7C*29P-0107	1/2
-	3.0709	78.00	1-7/32	13/32	<b>V7602S-78</b>	2	4C*2H-0107	1C12H-0107-TC	<b>V7629S-78</b>	29	7C*29P-0107	1/2
3-1/8	3.1250	79.38	1-7/32	13/32	<b>V7602S-0304</b>	2	4C*2H-0107	1C12H-0107-TC	<b>V7629S-0304</b>	29	7C*29P-0107	1/2
-	3.1496	80.00	1-7/32	13/32	<b>V7602S-80</b>	2	4C*2H-0107	1C12H-0107-TC	<b>V7629S-80</b>	29	7C*29P-0107	1/2
3-3/16	3.1875	80.96	1-7/32	13/32	<b>V7602S-0306</b>	2	4C*2H-0107	1C12H-0107-TC	<b>V7629S-0306</b>	29	7C*29P-0107	1/2
-	3.2282	82.00	1-7/32	13/32	<b>V7602S-82</b>	2	4C*2H-0107	1C12H-0107-TC	<b>V7629S-82</b>	29	7C*29P-0107	1/2
3-1/4	3.2500	82.55	1-7/32	13/32	<b>V7602S-0308</b>	2	4C*2H-0107	1C12H-0107-TC	<b>V7629S-0308</b>	29	7C*29P-0107	1/2

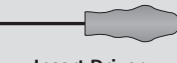

\*Denotes carbide grade (1 = C1, 2 = C2)

### IC Inserts

Coating	Size	Grade	Geometry	 Part No.	 Insert Screw	 Insert Driver	Admissible Tightening Torque*
AM300®	1/2	C5 (P35)	Standard	<b>OP-080508-PW</b>	74012-IP15-1	8IP-15	61.0 in-lbs (690 N-cm)
AM300®	1/2	C1 (K35)	Standard	<b>OP-080508-1PW</b>	74012-IP15-1	8IP-15	61.0 in-lbs (690 N-cm)
AM300®	1/2	C2 (K25)	Standard	<b>OP-080508-2PW</b>	74012-IP15-1	8IP-15	61.0 in-lbs (690 N-cm)
AM300®	1/2	C5 (P35)	High Rake	<b>OP-080508-PWHR</b>	74012-IP15-1	8IP-15	61.0 in-lbs (690 N-cm)

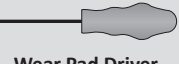

\*Tightening torques are calculated with a friction coefficient of  $\mu = 0.14$  and develop 90% of ultimate yield strength

### Wear Pads

 Part No.	 Wear Pad Screw	 Wear Pad Driver	Admissible Tightening Torque*
<b>WP7095</b>	7358-IP10-1	8IP-10	27.0 in-lbs (300 N-cm)

\*Tightening torques are calculated with a friction coefficient of  $\mu = 0.14$  and develop 90% of ultimate yield strength

### Pilot Accessories

Pilot Style	Series	 Insert Screws	 Insert Driver	Admissible Tightening Torque*
T-A	2	7495-IP15-1	8IP-15	61.0 in-lbs (690 N-cm)
GEN3SYS	29	7495-IP15-1	8IP-15	61.0 in-lbs (690 N-cm)

\*Tightening torques are calculated with a friction coefficient of  $\mu = 0.14$  and develop 90% of ultimate yield strength

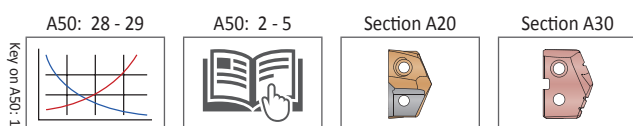

Non-stocked diameters are also available. Follow the examples shown below.

<b>Inch</b>	38 series, T-A (1 series), 1.6790"	Part No. = <b>V3801D-1.6790</b>
<b>Metric</b>	38 series, T-A (1 series), 42.15mm	Part No. = <b>V3801D-42.15</b>

Wear pads sold in multiples of 2 | Wear pad screws sold in multiples of 4  
IC inserts sold in multiples of 2 | Insert screws sold in multiples of 10

## APX Drill Holders

76 Series | Diameter Range: 2.9921" - 3.2676" (76.00mm - 82.99mm)

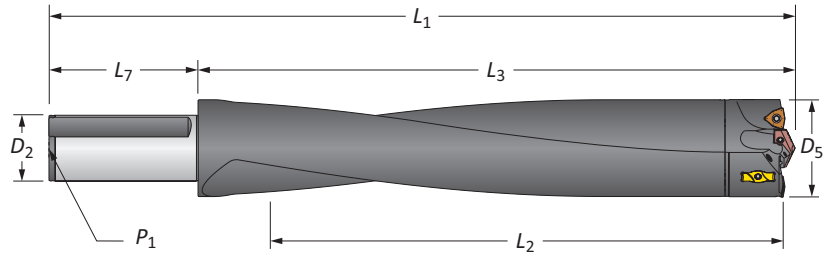

### Straight Shank

	Length	D <sub>5</sub>	Body			Shank			Part No.
			L <sub>2</sub>	L <sub>3</sub>	L <sub>1</sub>	L <sub>7</sub>	D <sub>2</sub>	P <sub>1</sub>	
i	3xD	2.9921 - 3.2676	9-1/2	11-33/64	16-1/64	4-1/2	2	1/4	W7603H-200F
	5xD	2.9921 - 3.2676	16-3/8	18-3/64	22-35/64	4-1/2	2	1/4	W7605H-200F
	8xD	2.9921 - 3.2676	26-1/8	27-27/32	32-11/32	4-1/2	2	1/4	W7608H-200F
m	3xD	76.00 - 82.99	239.9	292.4	372.4	80.0	50.0	1/4*	W7603H-50FM
	5xD	76.00 - 82.99	415.0	458.2	538.2	80.0	50.0	1/4*	W7605H-50FM
	8xD	76.00 - 82.99	664.0	707.1	787.1	80.0	50.0	1/4*	W7608H-50FM

\*Thread to BSP and ISO 7-1

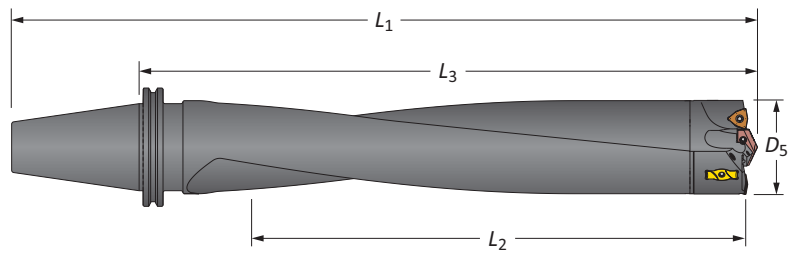

### CV50 Shank

	Length	D <sub>5</sub>		Body			Shank	Part No.
		inch	mm	L <sub>2</sub>	L <sub>3</sub>	L <sub>1</sub>		
i	3xD	2.9921 - 3.2676	76.00 - 82.99	9-1/2	12-57/64	16-57/64	CV50	W7603H-CV50
	5xD	2.9921 - 3.2676	76.00 - 82.99	16-3/8	19-27/64	23-27/64	CV50	W7605H-CV50
	8xD	2.9921 - 3.2676	76.00 - 82.99	26-1/8	29-7/32	33-7/32	CV50	W7608H-CV50

### Connection Accessories

Mounting Screw	Mounting Screw Bit	Admissible Tightening Torque*
78027-IP30-1	8IP-30B	250 in-lb (2825 N-cm)

\*Tightening torques are calculated with a friction coefficient of  $\mu = 0.14$  and develop 90% of ultimate yield strength

**⚠ WARNING** Refer to Speed and Feed charts for recommended adjustments to speeds and feeds. Refer to page A50: 30 for deep hole drilling guidelines in this section of the catalog. Visit [www.alliedmachine.com/DeepHoleGuidelines](http://www.alliedmachine.com/DeepHoleGuidelines) for the most up-to-date information and procedures. Factory technical assistance is available for your specific applications through our Application Engineering Team.

i = Imperial (in)  
m = Metric (mm)

Mounting screws sold in multiples of 4

**APX Drill Heads**

83 Series | Diameter Range: 3.2677" - 3.5038" (83.00mm - 88.99mm)

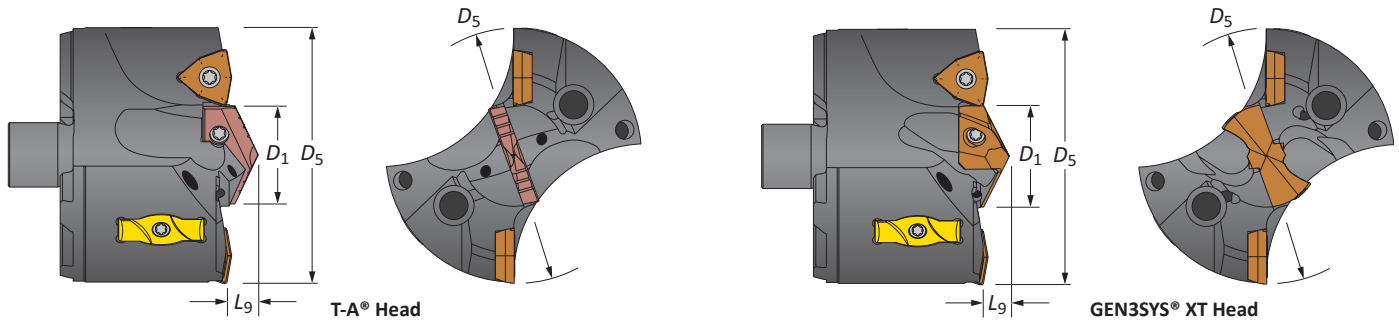

**Heads**

Head					T-A Head				GEN3SYS XT Head			
D <sub>5</sub> fractional	D <sub>5</sub> inch	D <sub>5</sub> mm	D <sub>1</sub>	L <sub>9</sub>	Part No.	Pilot Series	GEN2 T-A Insert	T-A (TC) Insert	Part No.	Pilot Series	Pilot Insert	IC Insert Size
-	3.3071	84.00	1-3/8	7/16	<b>V8302S-84</b>	2	4C*2H-0112	1C12H-0112-TC	<b>V8332S-84</b>	32	7C*32P-0112	1/2
3-5/16	3.3125	84.14	1-3/8	7/16	<b>V8302S-0310</b>	2	4C*2H-0112	1C12H-0112-TC	<b>V8332S-0310</b>	32	7C*32P-0112	1/2
3-3/8	3.3750	85.73	1-3/8	7/16	<b>V8302S-0312</b>	2	4C*2H-0112	1C12H-0112-TC	<b>V8332S-0312</b>	32	7C*32P-0112	1/2
-	3.3859	86.00	1-3/8	7/16	<b>V8302S-86</b>	2	4C*2H-0112	1C12H-0112-TC	<b>V8332S-86</b>	32	7C*32P-0112	1/2
3-7/16	3.4375	87.31	1-3/8	7/16	<b>V8302S-0314</b>	2	4C*2H-0112	1C12H-0112-TC	<b>V8332S-0314</b>	32	7C*32P-0112	1/2
-	3.4646	88.00	1-3/8	7/16	<b>V8302S-88</b>	2	4C*2H-0112	1C12H-0112-TC	<b>V8332S-88</b>	32	7C*32P-0112	1/2
3-1/2	3.5000	88.90	1-3/8	7/16	<b>V8302S-0316</b>	2	4C*2H-0112	1C12H-0112-TC	<b>V8332S-0316</b>	32	7C*32P-0112	1/2

\*Denotes carbide grade (1 = C1, 2 = C2)

**IC Inserts**

Coating	Size	Grade	Geometry	Part No.	Insert Screw	Insert Driver	Admissible Tightening Torque*
AM300®	1/2	C5 (P35)	Standard	<b>OP-080508-PW</b>	74012-IP15-1	8IP-15	61.0 in-lbs (690 N-cm)
AM300®	1/2	C1 (K35)	Standard	<b>OP-080508-1PW</b>	74012-IP15-1	8IP-15	61.0 in-lbs (690 N-cm)
AM300®	1/2	C2 (K25)	Standard	<b>OP-080508-2PW</b>	74012-IP15-1	8IP-15	61.0 in-lbs (690 N-cm)
AM300®	1/2	C5 (P35)	High Rake	<b>OP-080508-PWHR</b>	74012-IP15-1	8IP-15	61.0 in-lbs (690 N-cm)

\*Tightening torques are calculated with a friction coefficient of  $\mu = 0.14$  and develop 90% of ultimate yield strength

**Wear Pads**

Part No.	Wear Pad Screw	Wear Pad Driver	Admissible Tightening Torque*
<b>WP7095</b>	7358-IP10-1	8IP-10	27.0 in-lbs (300 N-cm)

\*Tightening torques are calculated with a friction coefficient of  $\mu = 0.14$  and develop 90% of ultimate yield strength

**Pilot Accessories**

Pilot Style	Series	Insert Screws	Insert Driver	Admissible Tightening Torque*
T-A	2	7495-IP15-1	8IP-15	61.0 in-lbs (690 N-cm)
GEN3SYS	32	7495-IP15-1	8IP-15	61.0 in-lbs (690 N-cm)

\*Tightening torques are calculated with a friction coefficient of  $\mu = 0.14$  and develop 90% of ultimate yield strength

A50: 28 - 29

A50: 2 - 5

Section A20

Section A30

Non-stocked diameters are also available. Follow the examples shown below.

<b>Inch</b>	38 series, T-A (1 series), 1.6790"	Part No. = <b>V3801D-1.6790</b>
<b>Metric</b>	38 series, T-A (1 series), 42.15mm	Part No. = <b>V3801D-42.15</b>

Wear pads sold in multiples of 2 | Wear pad screws sold in multiples of 4  
IC inserts sold in multiples of 2 | Insert screws sold in multiples of 10



## APX Drill Holders

83 Series | Diameter Range: 3.2677" - 3.5038" (83.00mm - 88.99mm)

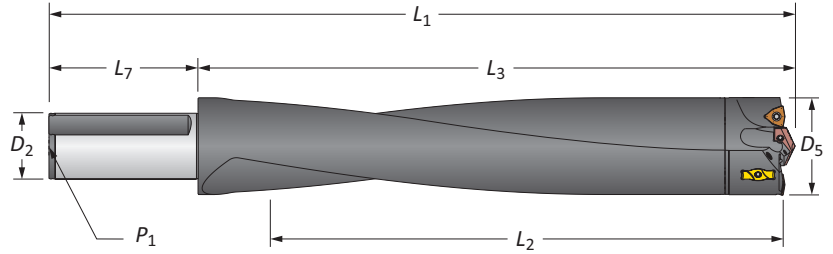

### Straight Shank

	Length	D <sub>5</sub>		Body			Shank		Part No.	
		inch	mm	L <sub>2</sub>	L <sub>3</sub>	L <sub>1</sub>	L <sub>7</sub>	D <sub>2</sub>		P <sub>1</sub>
i	3xD	3.2677 - 3.5038	83.00 - 88.99	10-1/8	12-5/16	16-13/16	4-1/2	2	1/4	W8303H-200F
	5xD	3.2677 - 3.5038	83.00 - 88.99	17-1/2	19-5/16	23-13/16	4-1/2	2	1/4	W8305H-200F
	8xD	3.2677 - 3.5038	83.00 - 88.99	27-3/4	29-35/64	34-3/64	4-1/2	2	1/4	W8308H-200F
m	3xD	83.00 - 88.99	83.00 - 88.99	257.8	312.5	392.6	80.0	50.0	1/4*	W8303H-50FM
	5xD	83.00 - 88.99	83.00 - 88.99	445.0	490.5	570.5	80.0	50.0	1/4*	W8305H-50FM
	8xD	83.00 - 88.99	83.00 - 88.99	704.9	750.3	830.3	80.0	50.0	1/4*	W8308H-50FM

\*Thread to BSP and ISO 7-1

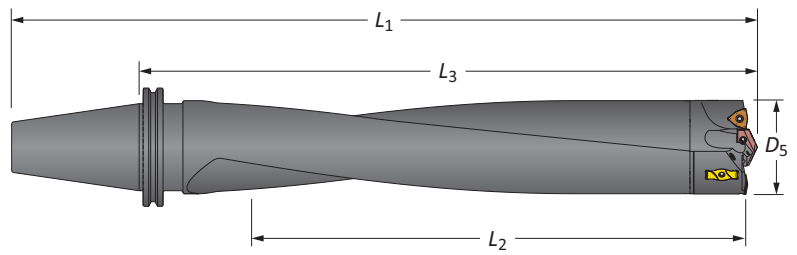

### CV50 Shank

	Length	D <sub>5</sub>		Body			Shank	Part No.
		inch	mm	L <sub>2</sub>	L <sub>3</sub>	L <sub>1</sub>		
i	3xD	3.2677 - 3.5038	83.00 - 88.99	10-1/8	13-11/16	17-11/16	CV50	W8303H-CV50
	5xD	3.2677 - 3.5038	83.00 - 88.99	17-1/2	20-11/16	24-11/16	CV50	W8305H-CV50
	8xD	3.2677 - 3.5038	83.00 - 88.99	26-7/8	30-3/64	34-3/64	CV50	W8308H-CV50

### Connection Accessories

Mounting Screw	Mounting Screw Bit	Admissible Tightening Torque*
78027-IP30-1	8IP-30B	250 in-lb (2825 N-cm)

\*Tightening torques are calculated with a friction coefficient of  $\mu = 0.14$  and develop 90% of ultimate yield strength

**⚠ WARNING** Refer to Speed and Feed charts for recommended adjustments to speeds and feeds. Refer to page A50: 30 for deep hole drilling guidelines in this section of the catalog. Visit [www.alliedmachine.com/DeepHoleGuidelines](http://www.alliedmachine.com/DeepHoleGuidelines) for the most up-to-date information and procedures. Factory technical assistance is available for your specific applications through our Application Engineering Team.

i = Imperial (in)  
m = Metric (mm)

Mounting screws sold in multiples of 4

APX Drill Heads

89 Series | Diameter Range: 3.5039" - 3.7401" (89.00mm - 94.99mm)

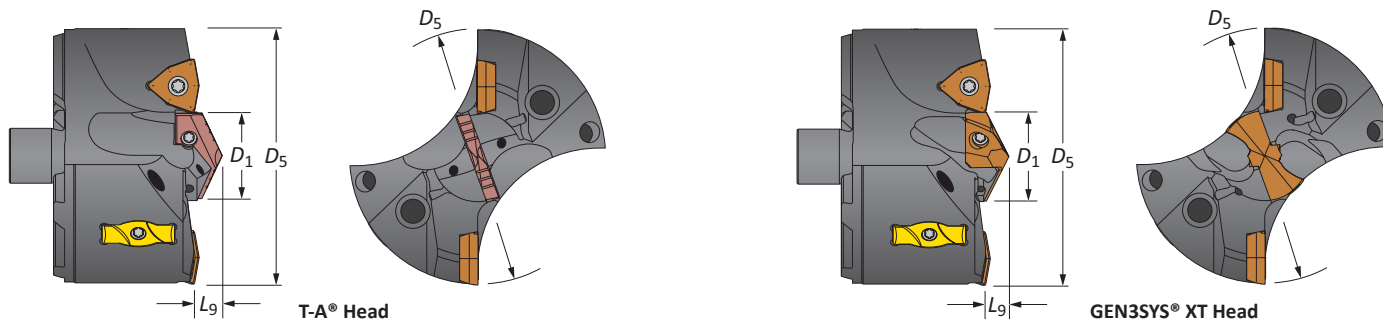

Heads

Head					T-A Head				GEN3SYS XT Head			IC Insert Size
D <sub>5</sub> fractional	D <sub>5</sub> inch	D <sub>5</sub> mm	D <sub>1</sub>	L <sub>9</sub>	Part No.	Pilot Series	GEN2 T-A Insert	T-A (TC) Insert	Part No.	Pilot Series	Pilot Insert	
-	3.5433	90.00	1-1/4	27/64	<b>V8902S-90</b>	2	4C*2H-0108	1C12H-0108-TC	<b>V8929S-90</b>	29	7C*29P-0108	9/16
3-9/16	3.5625	90.49	1-1/4	27/64	<b>V8902S-0318</b>	2	4C*2H-0108	1C12H-0108-TC	<b>V8929S-0318</b>	29	7C*29P-0108	9/16
-	3.6220	92.00	1-1/4	27/64	<b>V8902S-92</b>	2	4C*2H-0108	1C12H-0108-TC	<b>V8929S-92</b>	29	7C*29P-0108	9/16
3-5/8	3.6250	92.08	1-1/4	27/64	<b>V8902S-0320</b>	2	4C*2H-0108	1C12H-0108-TC	<b>V8929S-0320</b>	29	7C*29P-0108	9/16
3-11/16	3.6875	93.66	1-1/4	27/64	<b>V8902S-0322</b>	2	4C*2H-0108	1C12H-0108-TC	<b>V8929S-0322</b>	29	7C*29P-0108	9/16
-	3.7008	94.00	1-1/4	27/64	<b>V8902S-94</b>	2	4C*2H-0108	1C12H-0108-TC	<b>V8929S-94</b>	29	7C*29P-0108	9/16

\*Denotes carbide grade (1 = C1, 2 = C2)

IC Inserts

Coating	Size	Grade	Geometry	Part No.	Insert Screw	Insert Driver	Admissible Tightening Torque*
AM300®	9/16	C5 (P35)	Standard	<b>OP-090608-PW</b>	75014-IP20-1	8IP-20	121.0 in-lbs (1370 N-cm)
AM300®	9/16	C1 (K35)	Standard	<b>OP-090608-1PW</b>	75014-IP20-1	8IP-20	121.0 in-lbs (1370 N-cm)
AM300®	9/16	C2 (K25)	Standard	<b>OP-090608-2PW</b>	75014-IP20-1	8IP-20	121.0 in-lbs (1370 N-cm)
AM300®	9/16	C5 (P35)	High Rake	<b>OP-090608-PWHR</b>	75014-IP20-1	8IP-20	121.0 in-lbs (1370 N-cm)

\*Tightening torques are calculated with a friction coefficient of  $\mu = 0.14$  and develop 90% of ultimate yield strength

Wear Pads

Part No.	Wear Pad Screw	Wear Pad Driver	Admissible Tightening Torque*
<b>WP7095</b>	7358-IP10-1	8IP-10	27.0 in-lbs (300 N-cm)

\*Tightening torques are calculated with a friction coefficient of  $\mu = 0.14$  and develop 90% of ultimate yield strength

Pilot Accessories

Pilot Style	Series	Insert Screws	Insert Driver	Admissible Tightening Torque*
T-A	2	7495-IP15-1	8IP-15	61.0 in-lbs (690 N-cm)
GEN3SYS	29	7495-IP15-1	8IP-15	61.0 in-lbs (690 N-cm)

\*Tightening torques are calculated with a friction coefficient of  $\mu = 0.14$  and develop 90% of ultimate yield strength

A50: 28 - 29

A50: 2 - 5

Section A20

Section A30

Non-stocked diameters are also available. Follow the examples shown below.

<b>Inch</b>	38 series, T-A (1 series), 1.6790"	Part No. = <b>V3801D-1.6790</b>
<b>Metric</b>	38 series, T-A (1 series), 42.15mm	Part No. = <b>V3801D-42.15</b>

Wear pads sold in multiples of 2 | Wear pad screws sold in multiples of 4  
IC inserts sold in multiples of 2 | Insert screws sold in multiples of 10

A DRILLING  
B BORING  
C REAMING  
D BURNISHING  
E THREADING  
X SPECIALS



## APX Drill Holders

89 Series | Diameter Range: 3.5039" - 3.7401" (89.00mm - 94.99mm)

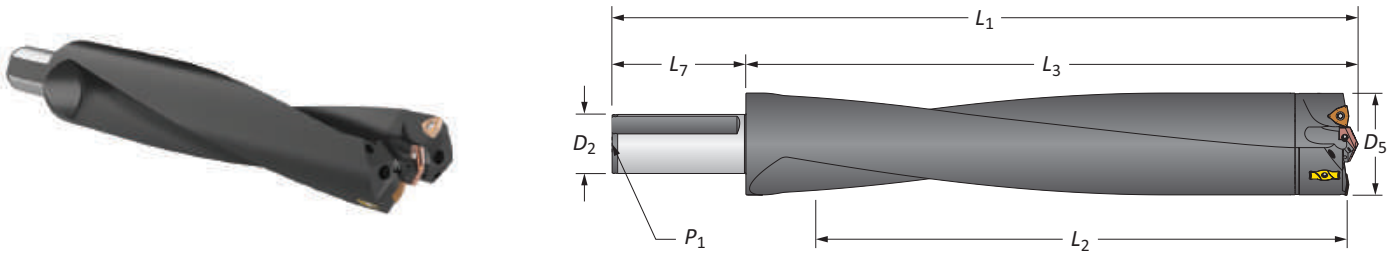

### Straight Shank

Length	D <sub>5</sub>	Body			Shank			Part No.	
		L <sub>2</sub>	L <sub>3</sub>	L <sub>1</sub>	L <sub>7</sub>	D <sub>2</sub>	P <sub>1</sub>		
i	3xD	3.5039 - 3.7401	10-7/8	13-1/8	17-5/8	4-1/2	2	1/4	W8903H-200F
	5xD	3.5039 - 3.7401	18-5/8	20-5/8	25-1/8	4-1/2	2	1/4	W8905H-200F
	8xD	3.5039 - 3.7401	27-5/8	29-35/64	34-3/64	4-1/2	2	1/4	W8908H-200F
m	3xD	89.00 - 94.99	275.8	333.6	413.6	80.0	50.0	1/4*	W8903H-50FM
	5xD	89.00 - 94.99	475.0	523.7	603.7	80.0	50.0	1/4*	W8905H-50FM
	8xD	89.00 - 94.99	701.8	750.3	830.3	80.0	50.0	1/4*	W8908H-50FM

\*Thread to BSP and ISO 7-1

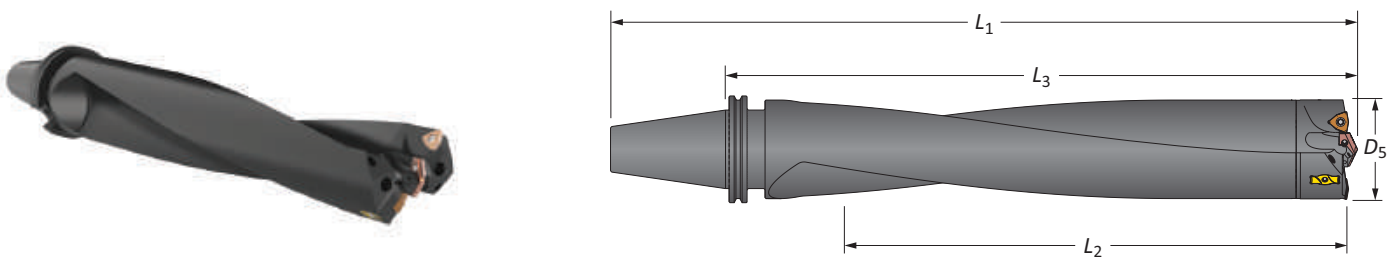

### CV50 Shank

Length	D <sub>5</sub>		Body			Shank	Part No.	
	inch	mm	L <sub>2</sub>	L <sub>3</sub>	L <sub>1</sub>			
i	3xD	3.5039 - 3.7401	89.00 - 94.99	10-7/8	14-33/64	18-33/64	CV50	W8903H-CV50
	5xD	3.5039 - 3.7401	89.00 - 94.99	18-5/8	22	26	CV50	W8905H-CV50
	8xD	3.5039 - 3.7401	89.00 - 94.99	26-3/4	30-1/32	34-1/32	CV50	W8908H-CV50

### Connection Accessories

Mounting Screw	Mounting Screw Bit	Admissible Tightening Torque*
78027-IP30-1	8IP-30B	250 in-lb (2825 N-cm)

\*Tightening torques are calculated with a friction coefficient of  $\mu = 0.14$  and develop 90% of ultimate yield strength

**WARNING** Refer to Speed and Feed charts for recommended adjustments to speeds and feeds. Refer to page A50: 30 for deep hole drilling guidelines in this section of the catalog. Visit [www.alliedmachine.com/DeepHoleGuidelines](http://www.alliedmachine.com/DeepHoleGuidelines) for the most up-to-date information and procedures. Factory technical assistance is available for your specific applications through our Application Engineering Team.

i = Imperial (in)  
m = Metric (mm)

Mounting screws sold in multiples of 4

A DRILLING  
B BORING  
C REAMING  
D BURNISHING  
E THREADING  
X SPECIALS

APX Drill Heads

95 Series | Diameter Range: 3.7402" - 4.0000" (95.00mm - 101.60mm)

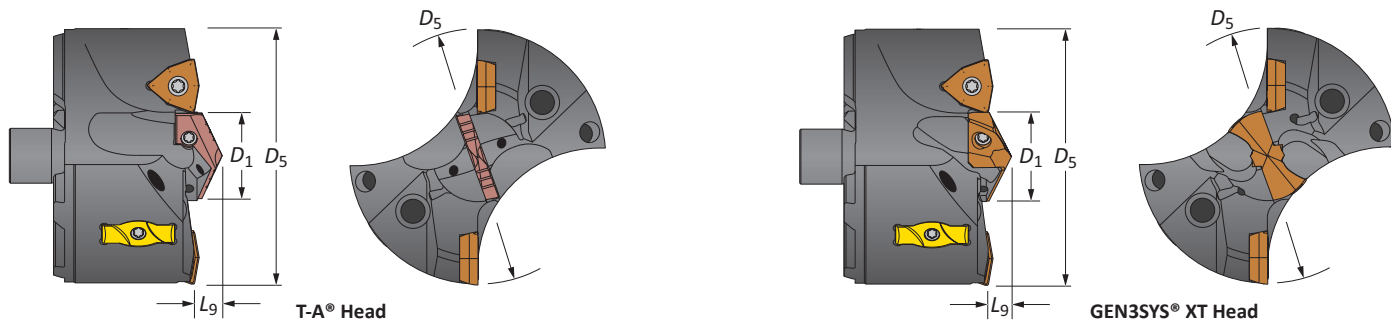

Heads

Head					T-A Head				GEN3SYS XT Head			
D <sub>5</sub> fractional	D <sub>5</sub> inch	D <sub>5</sub> mm	D <sub>1</sub>	L <sub>9</sub>	Part No.	Pilot Series	GEN2 T-A Insert	T-A (-TC) Insert	Part No.	Pilot Series	Pilot Insert	IC Insert Size
3-3/4	3.7500	95.25	1-3/8	29/64	V9502S-0324	2	4C*2H-0112	1C12H-0112-TC	V9532S-0324	32	7C*32P-0112	9/16
-	3.7795	96.00	1-3/8	29/64	V9502S-96	2	4C*2H-0112	1C12H-0112-TC	V9532S-96	32	7C*32P-0112	9/16
3-13/16	3.8125	96.84	1-3/8	29/64	V9502S-0326	2	4C*2H-0112	1C12H-0112-TC	V9532S-0326	32	7C*32P-0112	9/16
-	3.8583	98.00	1-3/8	29/64	V9502S-98	2	4C*2H-0112	1C12H-0112-TC	V9532S-98	32	7C*32P-0112	9/16
3-7/8	3.8750	98.43	1-3/8	29/64	V9502S-0328	2	4C*2H-0112	1C12H-0112-TC	V9532S-0328	32	7C*32P-0112	9/16
-	3.9370	100.00	1-3/8	29/64	V9502S-100	2	4C*2H-0112	1C12H-0112-TC	V9532S-100	32	7C*32P-0112	9/16
3-15/16	3.9375	100.01	1-3/8	29/64	V9502S-0330	2	4C*2H-0112	1C12H-0112-TC	V9532S-0330	32	7C*32P-0112	9/16
4	4.0000	101.60	1-3/8	29/64	V9502S-0400	2	4C*2H-0112	1C12H-0112-TC	V9532S-0400	32	7C*32P-0112	9/16

\*Denotes carbide grade (1 = C1, 2 = C2)

IC Inserts

Coating	Size	Grade	Geometry	Part No.	Insert Screw	Insert Driver	Admissible Tightening Torque*
AM300®	9/16	C5 (P35)	Standard	OP-090608-PW	75014-IP20-1	8IP-20	121.0 in-lbs (1370 N-cm)
AM300®	9/16	C1 (K35)	Standard	OP-090608-1PW	75014-IP20-1	8IP-20	121.0 in-lbs (1370 N-cm)
AM300®	9/16	C2 (K25)	Standard	OP-090608-2PW	75014-IP20-1	8IP-20	121.0 in-lbs (1370 N-cm)
AM300®	9/16	C5 (P35)	High Rake	OP-090608-PWHR	75014-IP20-1	8IP-20	121.0 in-lbs (1370 N-cm)

\*Tightening torques are calculated with a friction coefficient of  $\mu = 0.14$  and develop 90% of ultimate yield strength

Wear Pads

Part No.	Wear Pad Screw	Wear Pad Driver	Admissible Tightening Torque*
WP7095	7358-IP10-1	8IP-10	27.0 in-lbs (300 N-cm)

\*Tightening torques are calculated with a friction coefficient of  $\mu = 0.14$  and develop 90% of ultimate yield strength

Pilot Accessories

Pilot Style	Series	Insert Screws	Insert Driver	Admissible Tightening Torque*
T-A	2	7495-IP15-1	8IP-15	61.0 in-lbs (690 N-cm)
GEN3SYS	32	7495-IP15-1	8IP-15	61.0 in-lbs (690 N-cm)

\*Tightening torques are calculated with a friction coefficient of  $\mu = 0.14$  and develop 90% of ultimate yield strength

A50: 28 - 29 A50: 2 - 5 Section A20 Section A30

Key on A50: 1

Non-stocked diameters are also available. Follow the examples shown below.

Inch	38 series, T-A (1 series), 1.6790"	Part No. = V3801D-1.6790
Metric	38 series, T-A (1 series), 42.15mm	Part No. = V3801D-42.15

Wear pads sold in multiples of 2 | Wear pad screws sold in multiples of 4  
IC inserts sold in multiples of 2 | Insert screws sold in multiples of 10

A DRILLING  
B BORING  
C REAMING  
D BURISHING  
E THREADING  
X SPECIALS



## APX Drill Holders

95 Series | Diameter Range: 3.7402" - 4.0000" (95.00mm - 101.60mm)

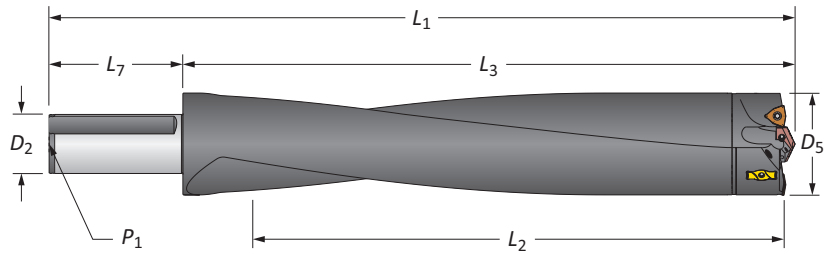

### Straight Shank

	Length	D <sub>5</sub>	Body			Shank			Part No.
			L <sub>2</sub>	L <sub>3</sub>	L <sub>1</sub>	L <sub>7</sub>	D <sub>2</sub>	P <sub>1</sub>	
i	3xD	3.7402 - 4.0000	11-7/8	14-9/32	18-25/32	4-1/2	2	1/4	W9503H-200F
	5xD	3.7402 - 4.0000	20	22-19/64	26-51/64	4-1/2	2	1/4	W9505H-200F
	8xD	3.7401 - 4.0000	27-1/2	29-51/64	34-19/64	4-1/2	2	1/4	W9508H-200F
m	3xD	95.00 - 101.60	302.0	362.8	442.8	80.0	50.0	1/4*	W9503H-50FM
	5xD	95.00 - 101.60	508.0	566.2	646.2	80.0	50.0	1/4*	W9505H-50FM
	8xD	95.00 - 101.60	698.5	756.7	836.7	80.0	50.0	1/4*	W9508H-50FM

\*Thread to BSP and ISO 7-1

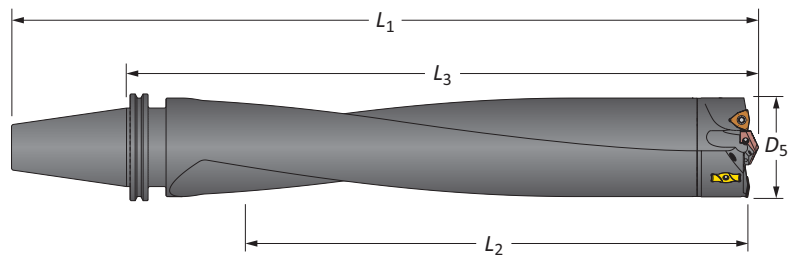

### CV50 Shank

	Length	D <sub>5</sub>		Body			Shank	Part No.
		inch	mm	L <sub>2</sub>	L <sub>3</sub>	L <sub>1</sub>		
i	3xD	3.7402 - 4.0000	95.00 - 101.60	11-7/8	15-43/64	19-43/64	CV50	W9503H-CV50
	5xD	3.7402 - 4.0000	95.00 - 101.60	20	23-43/64	27-43/64	CV50	W9505H-CV50
	8xD	3.7402 - 4.0000	95.00 - 101.60	26-5/8	30-9/32	34-9/32	CV50	W9508H-CV50

### Connection Accessories

Mounting Screw	Mounting Screw Bit	Admissible Tightening Torque*
78027-IP30-1	8IP-30B	250 in-lb (2825 N-cm)

\*Tightening torques are calculated with a friction coefficient of  $\mu = 0.14$  and develop 90% of ultimate yield strength

**WARNING** Refer to Speed and Feed charts for recommended adjustments to speeds and feeds. Refer to page A50: 30 for deep hole drilling guidelines in this section of the catalog. Visit [www.alliedmachine.com/DeepHoleGuidelines](http://www.alliedmachine.com/DeepHoleGuidelines) for the most up-to-date information and procedures. Factory technical assistance is available for your specific applications through our Application Engineering Team.

i = Imperial (in)  
m = Metric (mm)

Mounting screws sold in multiples of 4

## Recommended Drilling Data | Imperial (inch)

ISO	Material	Hardness (BHN)	Feed Rate (IPR) by Diameter								
			Outboard Insert		5/16" IC	3/8" IC	1/2" IC	9/16" IC	3/8" IC	1/2" IC	9/16" IC
			Series	Pilot Style	33	38 - 44	44 - 51	51 - 57 - 63	70	76 - 83	89 - 95
			Speed (SFM)		1.299 - 1.495	1.496 - 1.885	1.886 - 2.210	2.211 - 2.755	2.756 - 2.992	2.992 - 3.503	3.504 - 4.000
P	Free Machining Steel 1118, 1215, 12L14, etc.	100 - 250	450 - 750	T-A/GEN3SYS	.006 - .011	.007 - .012	.009 - .012	.009 - .012	.006 - .010	.007 - .011	.007 - .012
	Low Carbon Steel 1010, 1020, 1025, 1522, 1144, etc.	85 - 275	450 - 750	T-A/GEN3SYS	.006 - .011	.007 - .012	.009 - .012	.009 - .012	.006 - .010	.007 - .011	.007 - .012
	Medium Carbon Steel 1030, 1040, 1050, 1527, 1140, 1151, etc.	125 - 325	450 - 750	T-A/GEN3SYS	.006 - .011	.007 - .012	.009 - .012	.009 - .012	.006 - .010	.007 - .011	.007 - .012
	Alloy Steel 4140, 5140, 8640, etc.	125 - 375	400 - 700	T-A/GEN3SYS	.005 - .007	.005 - .009	.007 - .010	.007 - .011	.005 - .009	.006 - .010	.006 - .010
	High Strength Alloy 4340, 4330V, 300M, etc.	225 - 400	300 - 500	T-A/GEN3SYS	.005 - .006	.005 - .007	.005 - .008	.006 - .009	.005 - .007	.005 - .008	.006 - .008
	Structural Steel A36, A285, A516, etc.	100 - 350	450 - 750	T-A/GEN3SYS	.006 - .008	.007 - .009	.008 - .010	.009 - .011	.005 - .009	.006 - .010	.007 - .010
	Tool Steel H-13, H-21, A-4, O-2, S-3, etc.	150 - 250	300 - 500	T-A/GEN3SYS	.005 - .006	.005 - .007	.007 - .009	.008 - .010	.005 - .007	.006 - .009	.007 - .010
S	High Temp Alloy Hastelloy B, Inconel 600, etc.	140 - 310	200 - 400	T-A	.004 - .005	.004 - .007	.006 - .009	.007 - .009	.004 - .006	.005 - .007	.005 - .007
	Titanium Alloy	140 - 310	300 - 500	T-A	.005 - .007	.006 - .008	.007 - .009	.008 - .010	.004 - .006	.005 - .007	.005 - .007
	Aerospace Alloy S82	185 - 350	400 - 600	T-A/GEN3SYS	.004 - .006	.005 - .007	.006 - .008	.006 - .008	.004 - .006	.005 - .007	.005 - .007
M	Stainless Steel 400 Series 416, 420, etc.	185 - 350	300 - 500	T-A/GEN3SYS	.006 - .008	.007 - .009	.008 - .010	.009 - .011	.005 - .007	.007 - .009	.007 - .010
	Stainless Steel 300 Series 304, 316, 17-4PH, etc.	135 - 275	300 - 500	T-A/GEN3SYS	.005 - .007	.006 - .008	.007 - .009	.008 - .010	.004 - .008	.006 - .010	.006 - .010
	Super Duplex Stainless Steel	135 - 275	250 - 450	T-A/GEN3SYS	.004 - .006	.005 - .007	.007 - .009	.007 - .009	.004 - .007	.006 - .009	.007 - .010
H	Wear Plate Hardox, AR400, T-1, etc.	400 - 600	300 - 500	T-A	.003 - .005	.004 - .006	.006 - .008	.007 - .009	.003 - .005	.004 - .006	.004 - .006
	Hardened Steel	300 - 500	300 - 500	T-A	.004 - .005	.005 - .006	.006 - .008	.006 - .008	.003 - .005	.004 - .006	.004 - .006
K	Nodular, Grey, Ductile Cast Iron	120 - 320	500 - 800	T-A/GEN3SYS	.005 - .009	.006 - .010	.008 - .012	.010 - .012	.008 - .010	.009 - .011	.010 - .012
N	Cast Aluminum	30 - 180	600 - 800	T-A/GEN3SYS	.009 - .012	.010 - .014	.012 - .016	.012 - .016	.006 - .009	.008 - .011	.008 - .012
	Wrought Aluminum	30 - 180	600 - 800	T-A/GEN3SYS	.007 - .011	.008 - .012	.010 - .014	.010 - .014	.006 - .009	.008 - .011	.008 - .012
	Aluminum Bronze	100 - 250	400 - 700	T-A/GEN3SYS	.005 - .007	.005 - .008	.007 - .010	.009 - .011	.006 - .009	.007 - .010	.008 - .012
	Brass	30 - 100	800	T-A/GEN3SYS	.006 - .008	.007 - .009	.008 - .010	.009 - .012	.006 - .008	.007 - .009	.008 - .012
	Copper	60	700	T-A/GEN3SYS	.002 - .005	.003 - .006	.006 - .008	.008 - .010	.006 - .008	.006 - .008	.006 - .008

### Coolant Recommendations

Series	Pressure (PSI)	Flow Rate (GPM)
33	350	10
38	300	10
44	275	12
51	250	18
57	225	20
63	200	22
70	150	25
76	100	28
83	100	30
89	100	33
95	100	33

### Calculations

Value	Formula
SFM	$RPM \cdot 0.262 \cdot \text{Diameter}$
RPM	$(SFM \cdot 3.82) / \text{Diameter}$
IPM	$RPM \cdot \text{IPR}$

**IMPORTANT:** The speeds and feeds listed above are a general starting point for all applications. Refer to the Coolant Recommendation charts for coolant requirements to run at the recommended speeds and feeds. Factory technical assistance is also available through our Application Engineering Team.

**IMPORTANT:** The coolant pressure and flow rate recommendations above represent a good approximation to obtain optimum tool life and chip evacuation at Allied Machine recommended speeds and feeds. If lower coolant capabilities exist in a drilling application, the APX Drilling System will still function at reduced penetration rates. Contact our Application Engineering department for a more specific recommendation of coolant requirements and/or speeds and feeds.

**⚠ WARNING** Tool failure can cause serious injury. To prevent: For APX holders 8xD or longer, do not rotate tool more than 50 RPM unless it is engaged with workpiece or fixture. Refer to page A50: 30 for Deep Hole Drilling Guidelines in this section of the catalog. Visit [www.alliedmachine.com/DeepHoleGuidelines](http://www.alliedmachine.com/DeepHoleGuidelines) for the most up-to-date information and procedures. Factory technical assistance is also available for your specific applications.

**Recommended Drilling Data | Metric (mm)**

ISO	Material	Hardness (BHN)	Outboard Insert		Feed Rate (mm/rev) by Diameter						
			Series		5/16" IC	3/8" IC	1/2" IC	9/16" IC	3/8" IC	1/2" IC	9/16" IC
			Speed (M/min)	Pilot Style	33.00 - 37.99	38.00 - 47.88	47.89 - 56.13	56.14 - 69.99	70.00 - 75.99	76.00 - 88.99	89.00 - 101.60
P	Free Machining Steel 1118, 1215, 12L14, etc.	100 - 250	137 - 229	T-A/GEN3SYS	0.15 - 0.28	0.18 - 0.30	0.23 - 0.30	0.23 - 0.30	0.15 - 0.25	0.18 - 0.28	0.18 - 0.30
	Low Carbon Steel 1010, 1020, 1025, 1522, 1144, etc.	85 - 275	137 - 229	T-A/GEN3SYS	0.15 - 0.28	0.18 - 0.30	0.23 - 0.30	0.23 - 0.30	0.15 - 0.25	0.18 - 0.28	0.18 - 0.30
	Medium Carbon Steel 1030, 1040, 1050, 1527, 1140, 1151, etc.	125 - 325	137 - 229	T-A/GEN3SYS	0.15 - 0.28	0.18 - 0.30	0.23 - 0.30	0.23 - 0.30	0.15 - 0.25	0.18 - 0.28	0.18 - 0.30
	Alloy Steel 4140, 5140, 8640, etc.	125 - 375	122 - 213	T-A/GEN3SYS	0.13 - 0.18	0.13 - 0.23	0.18 - 0.25	0.18 - 0.28	0.13 - 0.23	0.15 - 0.25	0.15 - 0.25
	High Strength Alloy 4340, 4330V, 300M, etc.	225 - 400	91 - 152	T-A/GEN3SYS	0.13 - 0.15	0.13 - 0.18	0.13 - 0.20	0.15 - 0.23	0.13 - 0.18	0.13 - 0.20	0.15 - 0.20
	Structural Steel A36, A285, A516, etc.	100 - 350	137 - 229	T-A/GEN3SYS	0.15 - 0.20	0.18 - 0.23	0.20 - 0.25	0.23 - 0.28	0.13 - 0.23	0.15 - 0.25	0.15 - 0.25
	Tool Steel H-13, H-21, A-4, O-2, S-3, etc.	150 - 250	91 - 152	T-A/GEN3SYS	0.13 - 0.15	0.13 - 0.18	0.18 - 0.23	0.20 - 0.25	0.13 - 0.18	0.15 - 0.23	0.18 - 0.25
S	High Temp Alloy Hastelloy B, Inconel 600, etc.	140 - 310	61 - 122	T-A	0.10 - 0.13	0.10 - 0.18	0.15 - 0.23	0.18 - 0.23	0.10 - 0.15	0.13 - 0.18	0.13 - 0.18
	Titanium Alloy	140 - 310	91 - 152	T-A	0.13 - 0.18	0.15 - 0.20	0.18 - 0.23	0.20 - 0.25	0.10 - 0.15	0.13 - 0.18	0.13 - 0.18
	Aerospace Alloy S82	185 - 350	122 - 183	T-A/GEN3SYS	0.10 - 0.15	0.13 - 0.18	0.15 - 0.20	0.15 - 0.20	0.10 - 0.15	0.13 - 0.18	0.13 - 0.18
M	Stainless Steel 400 Series 416, 420, etc.	185 - 350	91 - 152	T-A/GEN3SYS	0.15 - 0.20	0.18 - 0.23	0.20 - 0.25	0.23 - 0.28	0.13 - 0.18	0.18 - 0.23	0.18 - 0.25
	Stainless Steel 300 Series 304, 316, 17-4PH, etc.	135 - 275	91 - 152	T-A/GEN3SYS	0.13 - 0.18	0.15 - 0.20	0.18 - 0.23	0.20 - 0.25	0.10 - 0.20	0.15 - 0.25	0.15 - 0.25
	Super Duplex Stainless Steel	135 - 275	76 - 137	T-A/GEN3SYS	0.10 - 0.15	0.13 - 0.18	0.18 - 0.23	0.18 - 0.23	0.10 - 0.18	0.15 - 0.23	0.18 - 0.25
H	Wear Plate Hardox, AR400, T-1, etc.	400 - 600	91 - 152	T-A	0.07 - 0.13	0.10 - 0.15	0.15 - 0.20	0.18 - 0.23	0.08 - 0.13	0.10 - 0.15	0.10 - 0.15
	Hardened Steel	300 - 500	91 - 152	T-A	0.10 - 0.13	0.13 - 0.15	0.15 - 0.20	0.15 - 0.20	0.08 - 0.13	0.10 - 0.20	0.10 - 0.20
K	Nodular, Grey, Ductile Cast Iron	120 - 320	152 - 244	T-A/GEN3SYS	0.13 - 0.23	0.15 - 0.25	0.20 - 0.30	0.25 - 0.30	0.20 - 0.25	0.23 - 0.28	0.25 - 0.30
N	Cast Aluminum	30 - 180	183 - 244	T-A/GEN3SYS	0.23 - 0.30	0.25 - 0.36	0.30 - 0.40	0.30 - 0.40	0.15 - 0.23	0.20 - 0.28	0.20 - 0.30
	Wrought Aluminum	30 - 180	183 - 244	T-A/GEN3SYS	0.18 - 0.28	0.20 - 0.30	0.25 - 0.36	0.25 - 0.36	0.15 - 0.23	0.20 - 0.28	0.20 - 0.30
	Aluminum Bronze	100 - 250	123 - 213	T-A/GEN3SYS	0.13 - 0.18	0.13 - 0.20	0.18 - 0.25	0.23 - 0.28	0.15 - 0.23	0.18 - 0.25	0.20 - 0.30
	Brass	30 - 100	244	T-A/GEN3SYS	0.15 - 0.20	0.18 - 0.23	0.20 - 0.25	0.23 - 0.30	0.15 - 0.20	0.18 - 0.23	0.20 - 0.25
	Copper	60	213	T-A/GEN3SYS	0.05 - 0.13	0.08 - 0.15	0.15 - 0.20	0.20 - 0.25	0.08 - 0.15	0.15 - 0.20	0.15 - 0.20

**Coolant Recommendations**

Series	Pressure (BAR)	Flow Rate (LPM)
33	24	38
38	21	38
44	19	45
51	17	68
57	16	76
63	14	83
70	10	95
76	7	106
83	7	114
89	7	125
95	7	125

**Calculations**

Value	Formula
M/min	RPM • 0.003 • Diameter
RPM	(M/min • 318.47) / Diameter
mm/min	RPM • mm/rev

**IMPORTANT:** The speeds and feeds listed above are a general starting point for all applications. Refer to the Coolant Recommendation charts for coolant requirements to run at the recommended speeds and feeds. Factory technical assistance is also available through our Application Engineering Team.

**IMPORTANT:** The coolant pressure and flow rate recommendations above represent a good approximation to obtain optimum tool life and chip evacuation at Allied Machine recommended speeds and feeds. If lower coolant capabilities exist in a drilling application, the APX Drilling System will still function at reduced penetration rates. Contact our Application Engineering department for a more specific recommendation of coolant requirements and/or speeds and feeds.

**WARNING** Tool failure can cause serious injury. To prevent: For APX holders 8xD or longer, do not rotate tool more than 50 RPM unless it is engaged with workpiece or fixture. Refer to page A50: 30 for Deep Hole Drilling Guidelines in this section of the catalog. Visit [www.alliedmachine.com/DeepHoleGuidelines](http://www.alliedmachine.com/DeepHoleGuidelines) for the most up-to-date information and procedures. Factory technical assistance is also available for your specific applications.

A  
DRILLING  
B  
BORING  
C  
REAMING  
D  
BURNISHING  
E  
THREADING  
X  
SPECIALS



## Deep Hole Drilling Guidelines

A

DRILLING



**1. Approach**  
50 RPM max  
12 IPM (300 mm/min)

Feed the longer drill within 1/16" (1.5mm) short of the workpiece at a **maximum of 50 RPM** and 12 IPM (300 mm/min) feed rate.

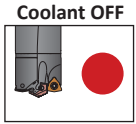
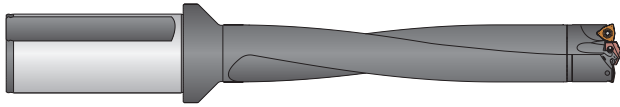

B

BORING

**2. Feed-in**  
Speed at 75% of recommended start  
Feed at 50% of recommended start

Drill 3/4" deep at 75% recommended speed and 50% recommended feed to establish the hole.

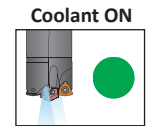
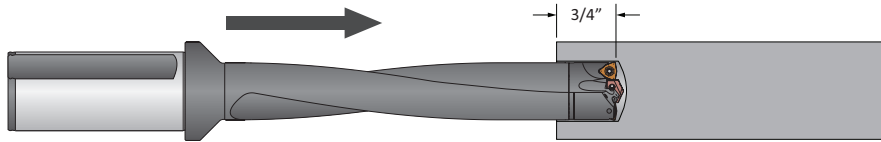

C

REAMING

**3. Deep Hole Drilling - Blind**  
100 % RPM  
100% IPR (mm/rev)

Drill to full depth at recommended speed and feed for longer drills (according to Allied Machine speed and feed charts).  
**\*No peck cycle recommended.**

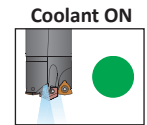
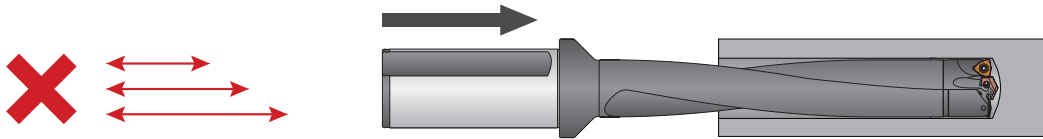

D

BURNISHING

**4. Deep Hole Drilling - at Breakout**  
50% RPM  
100% IPR (mm/rev)

**\*For through holes only:**  
Reduce speed by 50% prior to breakout.  
Do not break out more than 1/8" (3mm) past the full diameter of the drill.

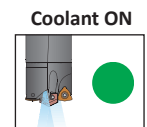
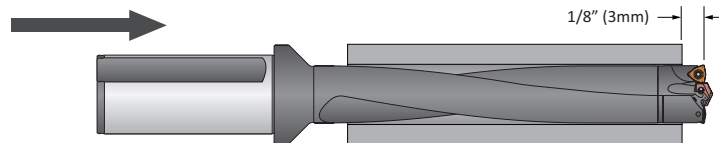

E

THREADING



**5. Drill Retract**  
50 RPM max

Reduce speed to a **maximum of 50 RPM** before retracting from the hole.

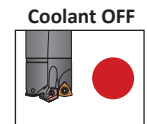
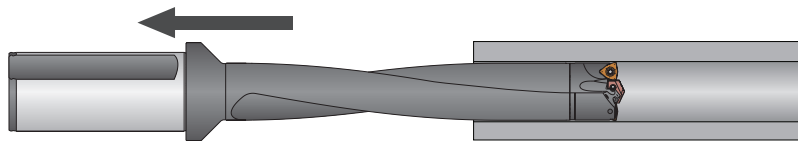

X

SPECIALS

**! WARNING** Tool failure can cause serious injury. To prevent: NEVER rotate these tool holders more than 50 RPM without proper engagement with a workpiece or fixture. Failure to do so could result in tool failure and/or personal injury. Visit [www.alliedmachine.com/DeepHoleGuidelines](http://www.alliedmachine.com/DeepHoleGuidelines) for the most up-to-date information and procedures. Factory technical assistance is also available for your specific applications.





SECTION

---

# A60

---

Revolution Drill®

# Revolution Drill®

## Large Diameter Replaceable IC Insert Drilling System

► Diameter Range: 1.875" - 4.000" (47.6mm - 101.0mm)



### Large Scale Innovation

The Revolution Drill has an innovative design that allows for adjustability of 0.200" (5.1mm) on diameter. This eliminates the need for special tooling and/or subsequent boring operations. With the ability to drill from solid, the Revolution Drill does not require a previously drilled pilot hole. The replaceable cartridges reduce set-up time, and the indexable inserts protect your investment. The insert design provides excellent chip control and aggressive penetration rates.

Drills from solid	Drill depths up to 4.5xD	Excellent chip control
-------------------	--------------------------	------------------------

### Applicable Industries



Aerospace



Agriculture



Automotive



Firearms



General Machining



Oil & Gas



Renewable Energy

Your safety and the safety of others is very important. This catalog contains important safety messages. Always read and follow all safety precautions.



This triangle is a safety hazard symbol. It alerts you to potential safety hazards that can cause tool failure and serious injury.

When you see this symbol in the catalog, look for a related safety message that may be near this triangle or referred to in the nearby text.

There are safety signal words also used in the catalog. Safety messages follow these words.

#### **WARNING**

**WARNING** (shown above) means that failure to follow the precautions in this message could result in tool failure and serious injury.

**NOTICE** means that failure to follow the precautions in this message could result in damage to the tool or machine but not result in personal injury.

**NOTE** and **IMPORTANT** are also used. These are important that you read and follow but are not safety-related.

Visit [www.alliedmachine.com](http://www.alliedmachine.com) for the most up-to-date information and procedures.



**Reference Icons**

The following icons will appear throughout the catalog to help you navigate between products.



**Setup / Assembly Information**

Detailed instructions and information regarding the corresponding part(s)

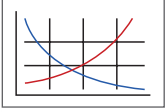

**Recommended Cutting Data**

Speed and feed recommendations for optimum and safe drilling

Series	Diameter Range	
	Imperial (inch)	Metric (mm)
34	1.875 - 2.000	47.6 - 50.8
36	2.000 - 2.200	50.8 - 55.9
38	2.200 - 2.400	55.9 - 61.0
42	2.400 - 2.600	61.0 - 66.0
44	2.600 - 2.800	66.0 - 71.1
46	2.800 - 3.000	71.1 - 76.2
48	3.000 - 3.200	76.2 - 81.3
52	3.200 - 3.400	81.3 - 86.4
54	3.400 - 3.600	86.4 - 91.4
56	3.600 - 3.800	91.4 - 96.5
58	3.800 - 4.000	96.5 - 101.6

**Introduction Information**

Product Overview . . . . . 2 - 3  
 Set-up Instructions . . . . . 4  
 Product Nomenclature . . . . . 5

**Drill Series**

34 Series . . . . . 6 - 7  
 36 Series . . . . . 8 - 9  
 38 Series . . . . . 10 - 11  
 42 Series . . . . . 12 - 13  
 44 Series . . . . . 14 - 15  
 46 Series . . . . . 16 - 17  
 48 Series . . . . . 18 - 19  
 52 Series . . . . . 20 - 21  
 54 Series . . . . . 22 - 23  
 56 Series . . . . . 24 - 25  
 58 Series . . . . . 26 - 27

**Recommended Cutting Data**

Imperial (inch) . . . . . 28  
 Metric (mm) . . . . . 29

## Product Overview

Series	Diameter Range		Length to Diameter Ratio	Shank Options			Inserts per Cartridge	Page
	Imperial (in)	Metric (mm)		Straight	CAT40	CAT50		
34	1.875 - 2.000	47.6 - 50.8	2.2, 3.5, 4.5	✓	✓	✓	2	6 - 7
36	2.000 - 2.200	50.8 - 55.9	2.2, 3.5, 4.5	✓	✓	✓	2	8 - 9
38	2.200 - 2.400	55.9 - 61.0	2.2, 3.5, 4.5	✓	✓	✓	2	10 - 11
42	2.400 - 2.600	61.0 - 66.0	2.2, 3.5, 4.5	✓	✓	✓	2	12 - 13
44	2.600 - 2.800	66.0 - 71.1	2.2, 3.5	✓		✓	3	14
46	2.800 - 3.000	71.1 - 76.2	2.2, 3.5	✓		✓	3	15
48	3.000 - 3.200	76.2 - 81.3	1.0, 2.5	✓		✓	3	16
52	3.200 - 3.400	81.3 - 86.4	1.0, 2.5	✓		✓	3	17
54	3.400 - 3.600	86.4 - 91.4	1.0, 2.5	✓		✓	3	18
56	3.600 - 3.800	91.4 - 96.5	1.0, 2.5	✓		✓	4	19
58	3.800 - 4.000	96.5 - 101.6	1.0, 2.5	✓		✓	4	20

NOTE: Stacked plate styles are also available

### Features & Benefits

- Adjustability of 0.200" (5.1mm) on diameter
- Drill depths up to 4.5xD (standard)
- The replaceable cartridges protect your investment
- Adjustable diameter reduces inventory and cost
- The insert design allows for excellent chip control and aggressive penetration rates
- No pilot hole needed

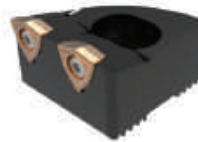

2 Inserts  
(34 - 42 series)



3 Inserts  
(44 - 54 series)



4 Inserts  
(56 - 58 series)



### Shank Options



Straight Shank  
(all series)



CAT40 Shank  
(34, 36, 38, 42 series)



CAT50 Shank  
(all series)

### Body Lengths

- 1.0xD (48, 52, 54, 56, 58 series)
- 2.2xD (34, 36, 38, 42, 44, 46 series)
- 2.5xD (48, 52, 54, 56, 58 series)
- 3.5xD (34, 36, 38, 42, 44, 46 series)
- 4.5xD (34, 36, 38, 42, 44, 46 series)

A  
DRILLING  
B  
BORING  
C  
REAMING  
D  
BURNISHING  
E  
THREADING  
X  
SPECIALS

**Product Overview**

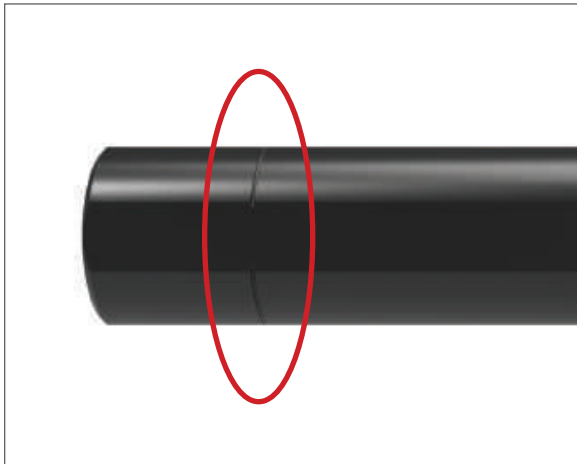
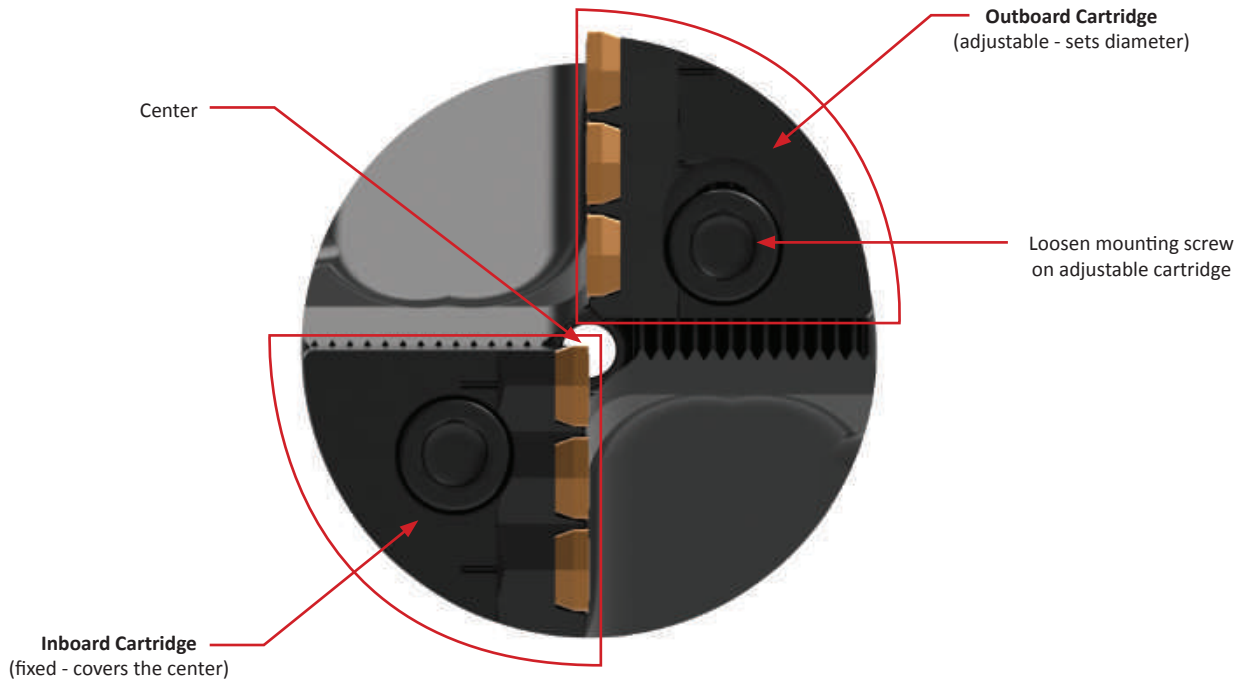

**Straight Shanks**

- Designed for lathe applications
- Can be cut off for use in end-mill holders
- The score mark (circled above) is provided for recommended cut length
- Cut and deburr at the score mark
- This improves rigidity when the body sits against the face of an end-mill holder



A  
DRILLING  
B  
BORING  
C  
REAMING  
D  
BURNISHING  
E  
THREADING  
X  
SPECIALS

## Set-up Instructions

A  
DRILLING  
B  
BORING  
C  
REAMING  
D  
BURNISHING  
E  
THREADING  
X  
SPECIALS

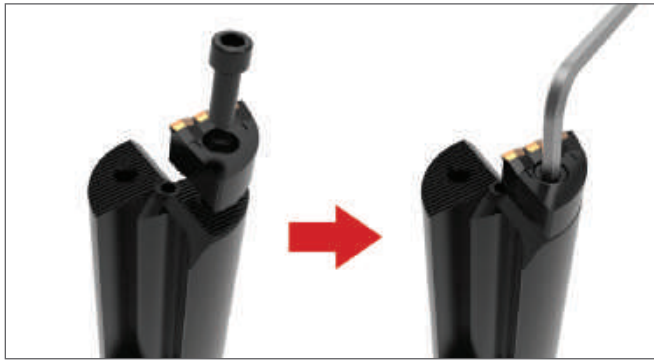

**Step 1:**  
Mount the fixed cartridge and tighten the mounting screw to 11-14 ft-lbf (15-19 N-m).

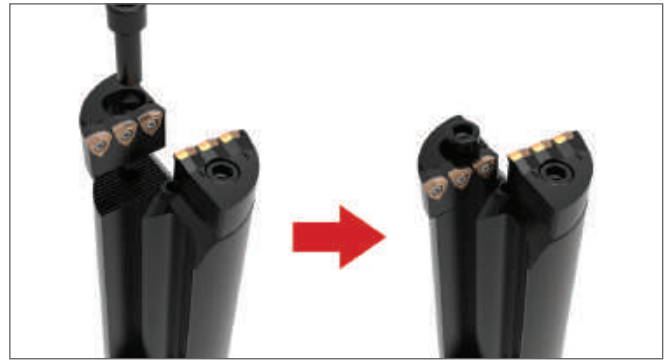

**Step 2:**  
Finger-tighten the mounting screw on the adjustable cartridge.



**Step 3:**  
Set the diameter using the adjustment screw against the mounting screw. Place the drill in a pre-setter to ensure the correct diameter setting.



**Step 4:**  
Tighten the mounting screw to 11-14 ft-lbf (15-19 N-m).

### IC Inserts

- The design allows for excellent chip control and aggressive penetration rates
- The proprietary AM200® and AM300® coatings increase tool life above competitors' premium coatings
- The same inserts are used for both Revolution Drill and Opening Drill products



AM300®



AM200®



TIN

### Insert Application Recommendations

#### Carbide Grade Options

C5 (P35)	General purpose carbide grade suitable for most applications. ▶ <i>Common application in steels and stainless steels.</i>
C1 (K35)	Toughest carbide grade. Provides the best combination of edge strength and tool life. ▶ <i>Recommended for less rigid applications.</i>
C2 (K25)	Higher wear resistant carbide suitable for abrasive material applications. ▶ <i>Recommended for grey, ductile, and nodular irons.</i>

#### Additional Geometry Option

High Rake (HR)	Provides superior chip control and tool life in long chipping carbon and alloy steels below 200 Bhn.
----------------	--

## Product Nomenclature

### Revolution Drill Holders

<b>R</b>	<b>34</b>	<b>X</b>	<b>22</b>	<b>-</b>	<b>150L</b>
1	2		3		4



1. Drill Style	2. Series	3. Length to Diameter Ratio	4. Shank Information
R = Standard SP = Stacked Plate	<b>34</b> = 34 series <b>44</b> = 44 series <b>54</b> = 54 series <b>36</b> = 36 series <b>46</b> = 46 series <b>56</b> = 56 series <b>38</b> = 38 series <b>48</b> = 48 series <b>58</b> = 58 series <b>42</b> = 42 series <b>52</b> = 52 series	<b>10</b> = 1.0xD <b>22</b> = 2.2xD <b>25</b> = 2.5xD <b>35</b> = 3.5xD <b>45</b> = 4.5xD	<b>150L</b> = 1-1/2 Ø straight <b>200L</b> = 2.0 Ø straight <b>40M</b> = 40mm ISO 9766 <b>50M</b> = 50mm ISO 9766 <b>CV40</b> = CAT40 <b>CV50</b> = CAT50

### Revolution Drill Inserts

<b>OP</b>	<b>-</b>	<b>05</b>	<b>T3</b>	<b>08</b>	<b>-</b>	<b>1</b>	<b>H</b>	<b>HR</b>
1		2	3	4		5	6	7

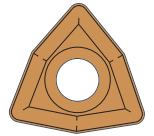

1. Compatible with:	2. IC Type	3. Thickness	4. Radius	5. Carbide Grade
Opening Drill Revolution Drill	<b>05</b> = 5/16"	<b>T3</b> = 5/32"	<b>08</b> = 1/32"	<b>Blank</b> = C5 (P35) <b>1</b> = C1 (K35) <b>2</b> = C2 (K25)
6. Coating	7. Geometry			
<b>P</b> = AM300® <b>H</b> = AM200® <b>T</b> = TiN <b>A</b> = TiAlN <b>N</b> = TiCN <b>U</b> = Uncoated	<b>Blank</b> = General Purpose <b>HR</b> = High Rake			

### Reference Key

Symbol	Attribute
$D_1$	Drill diameter range
$D_2$	Shank diameter
$L_1$	Overall length
$L_2$	Maximum drill depth
$L_4$	Holder length
$L_7$	Shank length
$P_1$	Rear pipe tap

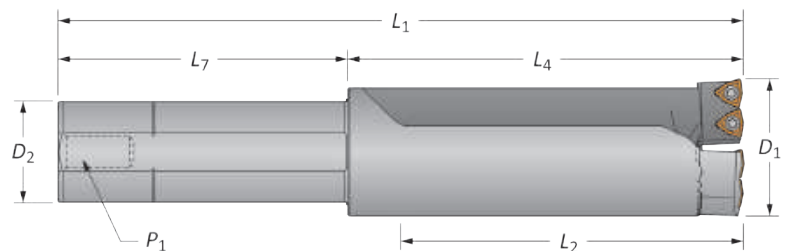

## Revolution Drill Holders

34 Series | Diameter Range: 1.875" - 2.000" (47.6mm - 50.8mm)

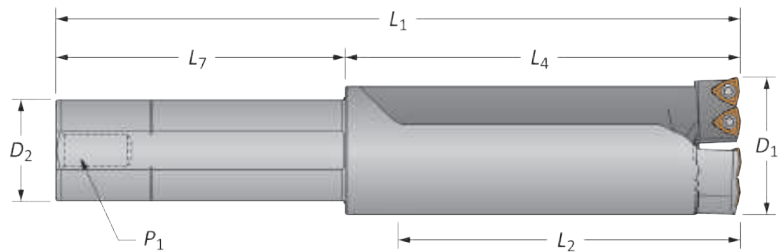

### Straight Shank Imperial

Style	Length	D <sub>1</sub> Range	Holder			Shank			Part No.*	Cartridges
			L <sub>2</sub>	L <sub>4</sub>	L <sub>1</sub>	D <sub>2</sub>	L <sub>7</sub>	P <sub>1</sub>		
Standard	2.2xD	1.875 - 2.000	4-17/32	5-13/32	9-13/32	1-1/2	4	1/4	R34X22-150L	C34-...
Standard	3.5xD	1.875 - 2.000	7-1/32	7-29/32	11-29/32	1-1/2	4	1/4	R34X35-150L	C34-...
Standard	4.5xD	1.875 - 2.000	9-1/32	9-29/32	13-29/32	1-1/2	4	1/4	R34X45-150L	C34-...
Stacked Plate	2.2xD	1.875 - 2.000	4-27/64	5-5/16	9-5/16	1-1/2	4	1/4	SP34X22-150L	C34SP-...

\*Holder includes cartridges; however, inserts are sold separately.

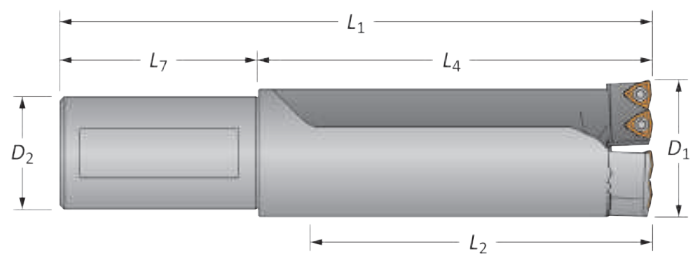

### Straight Shank Metric

Style	Length	D <sub>1</sub> Range	Holder			Shank			Part No.*	Cartridges
			L <sub>2</sub>	L <sub>4</sub>	L <sub>1</sub>	D <sub>2</sub>	L <sub>7</sub>	P <sub>1</sub>		
Standard	2.2xD	47.6 - 50.8	114.9	137.4	207.4	40	70	-	R34X22-40M	C34-...
Standard	3.5xD	47.6 - 50.8	178.4	200.9	270.9	40	70	-	R34X35-40M	C34-...
Standard	4.5xD	47.6 - 50.8	229.2	251.7	321.7	40	70	-	R34X45-40M	C34-...
Stacked Plate	2.2xD	47.6 - 50.8	112.4	134.8	204.8	40	70	-	SP34X22-40M	C34SP-...

\*Holder includes cartridges; however, inserts are sold separately.

A60: 22 - 23

A60: 2 - 4

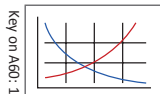

**i** = Imperial (in)  
**m** = Metric (mm)



## Revolution Drill Holders

34 Series | Diameter Range: 1.875" - 2.000" (47.6mm - 50.8mm)

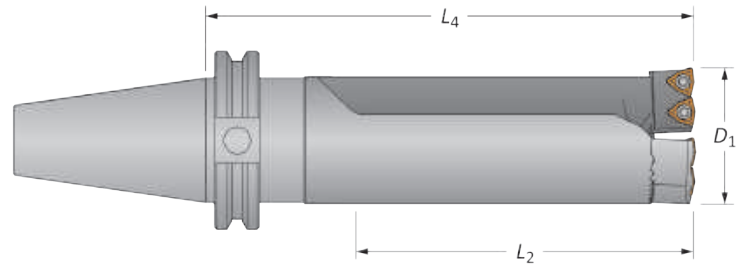

### CV40 Shank

Style	Length	D <sub>1</sub> Range	Holder		Shank	Part No.*	Cartridges
			L <sub>2</sub>	L <sub>4</sub>			
Standard	2.2xD	1.875 - 2.000	4-17/32	6-25/32	CV40	R34X22-CV40	C34-...
Standard	3.5xD	1.875 - 2.000	7-1/32	9-9/32	CV40	R34X35-CV40	C34-...
Standard	4.5xD	1.875 - 2.000	9-1/32	11-9/32	CV40	R34X45-CV40	C34-...
Stacked Plate	2.2xD	1.875 - 2.000	4-27/64	6-11/16	CV40	SP34X22-CV40	C34SP-...

\*Holder includes cartridges; however, inserts are sold separately.

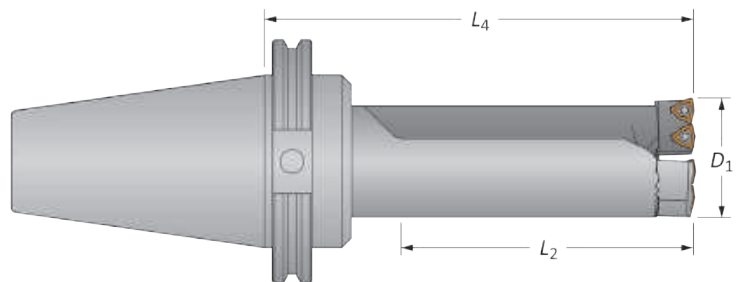

### CV50 Shank

Style	Length	D <sub>1</sub> Range	Holder		Shank	Part No.*	Cartridges
			L <sub>2</sub>	L <sub>4</sub>			
Standard	2.2xD	1.875 - 2.000	4-17/32	6-25/32	CV50	R34X22-CV50	C34-...
Standard	3.5xD	1.875 - 2.000	7-1/32	9-9/32	CV50	R34X35-CV50	C34-...
Standard	4.5xD	1.875 - 2.000	9-1/32	11-9/32	CV50	R34X45-CV50	C34-...
Stacked Plate	2.2xD	1.875 - 2.000	4-27/64	6-11/16	CV50	SP34X22-CV50	C34SP-...

\*Holder includes cartridges; however, inserts are sold separately.

### Cartridges

Holder Part No.	Replacement Cartridges	Qty. Inserts Needed	Mounting Screw	Key Size	Adjusting Screw	Driver
R34...	C34-FIX	2	MS-17M-1	5mm	AS-16T9-1	8T-9
	C34-ADJ	2	MS-17M-1	5mm	AS-16T9-1	8T-9
SP34...	C34SP-FIX	2	MS-17M-1	5mm	AS-16T9-1	8T-9
	C34SP-ADJ	2	MS-17M-1	5mm	AS-16T9-1	8T-9

### IC Inserts

Carbide Grade	Geometry	Part No.			Insert Screws	Driver
		AM300®	AM200®	TiN		
C5 (P35)	Standard	OP-05T308-P	OP-05T308-H	OP-05T308-T	IS-10-1	8T-9
C1 (K35)	Standard	OP-05T308-1P	OP-05T308-1H	OP-05T308-1T	IS-10-1	8T-9
C2 (K25)	Standard	OP-05T308-2P	OP-05T308-2H	-	IS-10-1	8T-9
C5 (P35)	High Rake	OP-05T308-PHR	OP-05T308-HHR	-	IS-10-1	8T-9

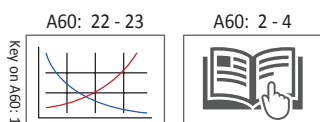

Mounting screws sold in multiples of 4 | Adjusting screws sold in multiples of 4  
 IC inserts sold in multiples of 10 | Insert screws sold in multiples of 10

**i** = Imperial (in)  
**m** = Metric (mm)

## Revolution Drill Holders

36 Series | Diameter Range: 2.000" - 2.200" (50.8mm - 55.9mm)

A DRILLING

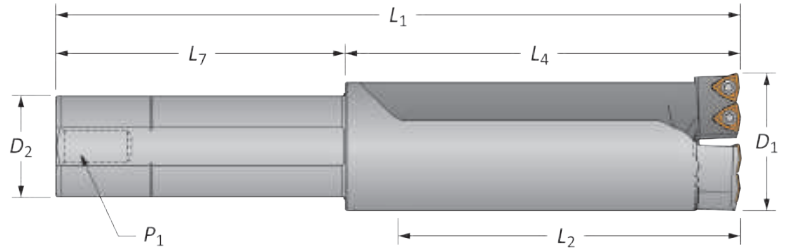

B BORING

### Straight Shank Imperial

Style	Length	D <sub>1</sub> Range	Holder			Shank			Part No.*	Cartridges
			L <sub>2</sub>	L <sub>4</sub>	L <sub>1</sub>	D <sub>2</sub>	L <sub>7</sub>	P <sub>1</sub>		
Standard	2.2xD	2.000 - 2.200	4-61/64	5-57/64	9-57/64	1-1/2	4	1/4	R36X22-150L	C36-...
Standard	3.5xD	2.000 - 2.200	7-45/64	8-41/64	12-41/64	1-1/2	4	1/4	R36X35-150L	C36-...
Standard	4.5xD	2.000 - 2.200	9-61/64	10-57/64	14-57/64	1-1/2	4	1/4	R36X45-150L	C36-...
Stacked Plate	2.2xD	2.000 - 2.200	4-57/64	5-13/16	9-13/16	1-1/2	4	1/4	SP36X22-150L	C36SP-...

\*Holder includes cartridges; however, inserts are sold separately.

C REAMING

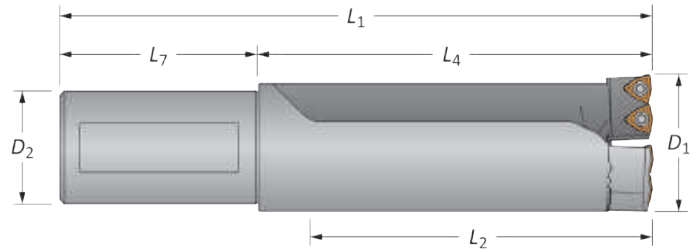

D BURNISHING

### Straight Shank Metric

Style	Length	D <sub>1</sub> Range	Holder			Shank			Part No.*	Cartridges
			L <sub>2</sub>	L <sub>4</sub>	L <sub>1</sub>	D <sub>2</sub>	L <sub>7</sub>	P <sub>1</sub>		
Standard	2.2xD	50.8 - 55.9	126.0	149.6	219.6	40	70	-	R36X22-40M	C36-...
Standard	3.5xD	50.8 - 55.9	195.8	219.4	289.4	40	70	-	R36X35-40M	C36-...
Standard	4.5xD	50.8 - 55.9	253.0	276.6	346.6	40	70	-	R36X45-40M	C36-...
Stacked Plate	2.2xD	50.8 - 55.9	124.0	147.6	217.6	40	70	-	SP36X22-40M	C36SP-...

\*Holder includes cartridges; however, inserts are sold separately.

F THREADING

X SPECIALS

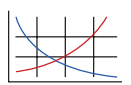
A60: 22 - 23  Key on A60: 1

A60: 2 - 4 

**i** = Imperial (in)  
**m** = Metric (mm)





## Revolution Drill Holders

36 Series | Diameter Range: 2.000" - 2.200" (50.8mm - 55.9mm)

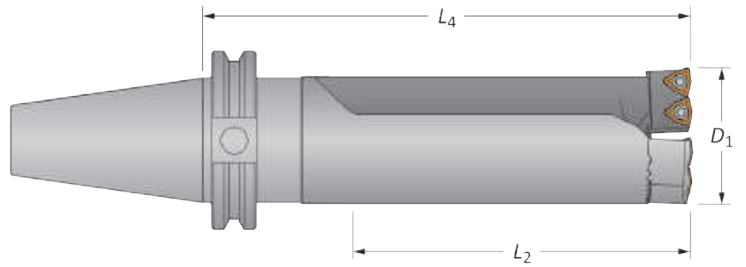

### CV40 Shank

Style	Length	D <sub>1</sub> Range	Holder		Shank	Part No.*	Cartridges	
			L <sub>2</sub>	L <sub>4</sub>				
i	Standard	2.2xD	2.000 - 2.200	4-61/64	7-17/64	CV40	R36X22-CV40	C36-...
	Standard	3.5xD	2.000 - 2.200	7-45/64	10-1/64	CV40	R36X35-CV40	C36-...
	Standard	4.5xD	2.000 - 2.200	9-61/64	12-17/64	CV40	R36X45-CV40	C36-...
	Stacked Plate	2.2xD	2.000 - 2.200	4-57/64	7-35/64	CV40	SP36X22-CV40	C36SP-...

\*Holder includes cartridges; however, inserts are sold separately.

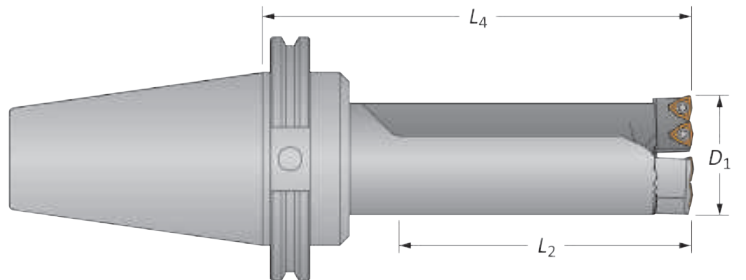

### CV50 Shank

Style	Length	D <sub>1</sub> Range	Holder		Shank	Part No.*	Cartridges	
			L <sub>2</sub>	L <sub>4</sub>				
i	Standard	2.2xD	2.000 - 2.200	4-61/64	7-17/64	CV50	R36X22-CV50	C36-...
	Standard	3.5xD	2.000 - 2.200	7-45/64	10-1/64	CV50	R36X35-CV50	C36-...
	Standard	4.5xD	2.000 - 2.200	9-61/64	12-17/64	CV50	R36X45-CV50	C36-...
	Stacked Plate	2.2xD	2.000 - 2.200	4-57/64	7-35/64	CV50	SP36X22-CV50	C36SP-...

\*Holder includes cartridges; however, inserts are sold separately.

### Cartridges

Holder Part No.	Replacement Cartridges	Qty. Inserts Needed	Mounting Screw	Key Size	Adjusting Screw	Driver
R36...	C36-FIX	2	MS-17M-1	5mm	AS-18T9-1	8T-9
	C36-ADJ	2	MS-17M-1	5mm	AS-18T9-1	8T-9
SP36...	C36SP-FIX	2	MS-17M-1	5mm	AS-18T9-1	8T-9
	C36SP-ADJ	2	MS-17M-1	5mm	AS-18T9-1	8T-9

### IC Inserts

Carbide Grade	Geometry	Part No.			Insert Screws	Driver
		AM300®	AM200®	TiN		
C5 (P35)	Standard	OP-05T308-P	OP-05T308-H	OP-05T308-T	IS-10-1	8T-9
C1 (K35)	Standard	OP-05T308-1P	OP-05T308-1H	OP-05T308-1T	IS-10-1	8T-9
C2 (K25)	Standard	OP-05T308-2P	OP-05T308-2H	-	IS-10-1	8T-9
C5 (P35)	High Rake	OP-05T308-PHR	OP-05T308-HHR	-	IS-10-1	8T-9

A60: 22 - 23 A60: 2 - 4

Mounting screws sold in multiples of 4 | Adjusting screws sold in multiples of 4  
 IC inserts sold in multiples of 10 | Insert screws sold in multiples of 10

i = Imperial (in)  
 m = Metric (mm)

A  
DRILLING  
B  
BORING  
C  
REAMING  
D  
BURNISHING  
E  
THREADING  
X  
SPECIALS

## Revolution Drill Holders

38 Series | Diameter Range: 2.200" - 2.400" (55.9mm - 61.0mm)

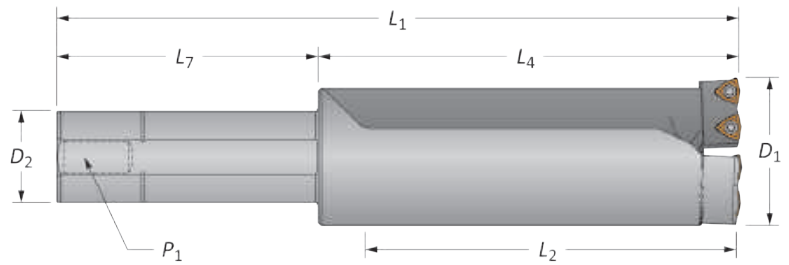

### Straight Shank Imperial

Style	Length	D <sub>1</sub> Range	Holder			Shank			Part No.*	Cartridges
			L <sub>2</sub>	L <sub>4</sub>	L <sub>1</sub>	D <sub>2</sub>	L <sub>7</sub>	P <sub>1</sub>		
Standard	2.2xD	2.200 - 2.400	5-29/64	6-25/64	10-25/64	1-1/2	4	1/4	R38X22-150L	C38-...
Standard	3.5xD	2.200 - 2.400	8-29/64	9-25/64	13-25/64	1-1/2	4	1/4	R38X35-150L	C38-...
Standard	4.5xD	2.200 - 2.400	10-61/64	11-57/64	15-57/64	1-1/2	4	1/4	R38X45-150L	C38-...
Stacked Plate	2.2xD	2.200 - 2.400	5-3/8	6-19/64	10-19/64	1-1/2	4	1/4	SP38X22-150L	C38SP-...

\*Holder includes cartridges; however, inserts are sold separately.

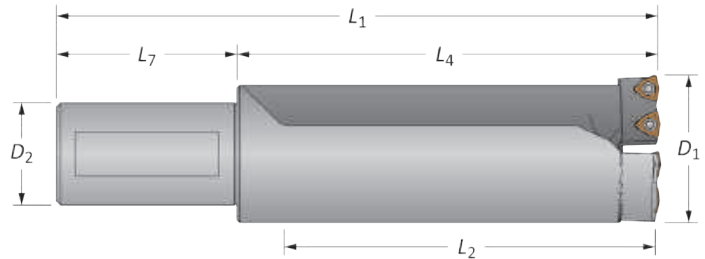

### Straight Shank Metric

Style	Length	D <sub>1</sub> Range	Holder			Shank			Part No.*	Cartridges
			L <sub>2</sub>	L <sub>4</sub>	L <sub>1</sub>	D <sub>2</sub>	L <sub>7</sub>	P <sub>1</sub>		
Standard	2.2xD	55.9 - 61.0	138.7	162.2	232.2	40	70	-	R38X22-40M	C38-...
Standard	3.5xD	55.9 - 61.0	214.9	238.4	308.4	40	70	-	R38X35-40M	C38-...
Standard	4.5xD	55.9 - 61.0	278.4	301.9	371.9	40	70	-	R38X45-40M	C38-...
Stacked Plate	2.2xD	55.9 - 61.0	136.5	160.0	230.0	40	70	-	SP38X22-40M	C38SP-...

\*Holder includes cartridges; however, inserts are sold separately.

A DRILLING

B BORING

C REAMING

D BURNISHING

F THREADING

X SPECIALS

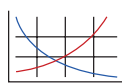
A60: 22 - 23  Key on A60: 1

A60: 2 - 4 

**i** = Imperial (in)  
**m** = Metric (mm)



## Revolution Drill Holders

38 Series | Diameter Range: 2.200" - 2.400" (55.9mm - 61.0mm)

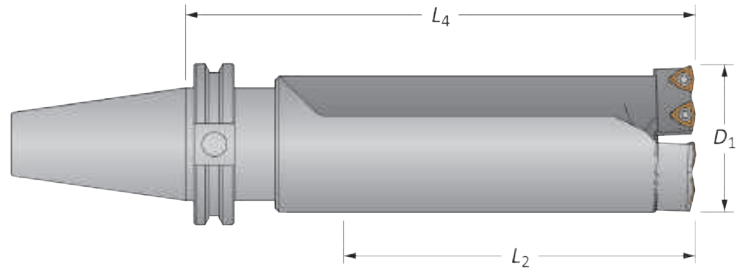

### CV40 Shank

Style	Length	D <sub>1</sub> Range	Holder		Shank	Part No.*	Cartridges
			L <sub>2</sub>	L <sub>4</sub>			
Standard	2.2xD	2.200 - 2.400	5-29/64	7-49/64	CV40	<b>R38X22-CV40</b>	C38-...
Standard	3.5xD	2.200 - 2.400	8-29/64	10-49/64	CV40	<b>R38X35-CV40</b>	C38-...
Standard	4.5xD	2.200 - 2.400	10-61/64	13-17/64	CV40	<b>R38X45-CV40</b>	C38-...
Stacked Plate	2.2xD	2.200 - 2.400	5-3/8	7-43/64	CV40	<b>SP38X22-CV40</b>	C38SP-...

\*Holder includes cartridges; however, inserts are sold separately.

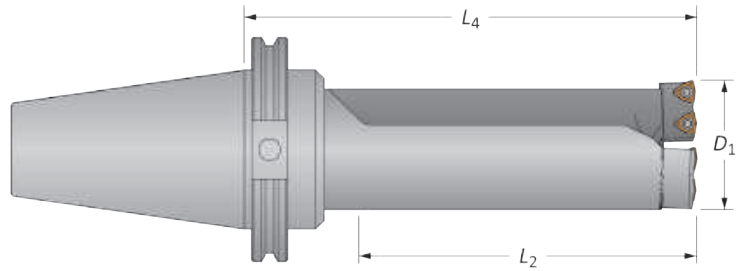

### CV50 Shank

Style	Length	D <sub>1</sub> Range	Holder		Shank	Part No.*	Cartridges
			L <sub>2</sub>	L <sub>4</sub>			
Standard	2.2xD	2.200 - 2.400	5-29/64	7-49/64	CV50	<b>R38X22-CV50</b>	C38-...
Standard	3.5xD	2.200 - 2.400	8-29/64	10-49/64	CV50	<b>R38X35-CV50</b>	C38-...
Standard	4.5xD	2.200 - 2.400	10-61/64	13-17/64	CV50	<b>R38X45-CV50</b>	C38-...
Stacked Plate	2.2xD	2.200 - 2.400	5-3/8	7-43/64	CV50	<b>SP38X22-CV50</b>	C38SP-...

\*Holder includes cartridges; however, inserts are sold separately.

### Cartridges

Holder Part No.	Replacement Cartridges	Qty. Inserts Needed	Mounting Screw	Key Size	Adjusting Screw	Driver
R38...	C38-FIX	2	MS-17M-1	5mm	AS-18T9-1	8T-9
	C38-ADJ	2	MS-17M-1	5mm	AS-18T9-1	8T-9
SP38...	C38SP-FIX	2	MS-17M-1	5mm	AS-18T9-1	8T-9
	C38SP-ADJ	2	MS-17M-1	5mm	AS-18T9-1	8T-9

### IC Inserts

Carbide Grade	Geometry	Part No.			Insert Screws	Driver
		AM300®	AM200®	TiN		
C5 (P35)	Standard	OP-05T308-P	OP-05T308-H	OP-05T308-T	IS-10-1	8T-9
C1 (K35)	Standard	OP-05T308-1P	OP-05T308-1H	OP-05T308-1T	IS-10-1	8T-9
C2 (K25)	Standard	OP-05T308-2P	OP-05T308-2H	-	IS-10-1	8T-9
C5 (P35)	High Rake	OP-05T308-PHR	OP-05T308-HHR	-	IS-10-1	8T-9

A60: 22 - 23

A60: 2 - 4

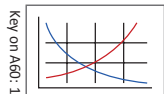

Mounting screws sold in multiples of 4 | Adjusting screws sold in multiples of 4  
 IC inserts sold in multiples of 10 | Insert screws sold in multiples of 10

ⓘ = Imperial (in)  
 Ⓜ = Metric (mm)



## Revolution Drill Holders

42 Series | Diameter Range: 2.400" - 2.600" (61.0mm - 66.0mm)

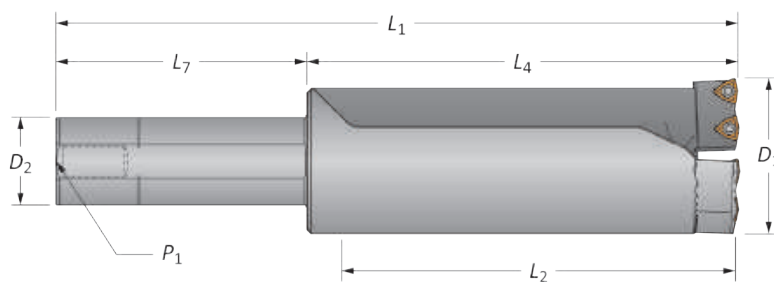

### Straight Shank Imperial

Style	Length	D <sub>1</sub> Range	Holder			Shank			Part No.*	Cartridges
			L <sub>2</sub>	L <sub>4</sub>	L <sub>1</sub>	D <sub>2</sub>	L <sub>7</sub>	P <sub>1</sub>		
Standard	2.2xD	2.400 - 2.600	5-45/64	6-49/64	10-49/64	1-1/2	4	1/4	R42X22-150L	C42-...
Standard	3.5xD	2.400 - 2.600	9-13/64	10-17/64	14-17/64	1-1/2	4	1/4	R42X35-150L	C42-...
Standard	4.5xD	2.400 - 2.600	11-45/64	12-49/64	16-49/64	1-1/2	4	1/4	R42X45-150L	C42-...
Stacked Plate	2.2xD	2.400 - 2.600	5-3/4	6-13/16	10-13/16	1-1/2	4	1/4	SP42X22-150L	C42SP-...

\*Holder includes cartridges; however, inserts are sold separately.

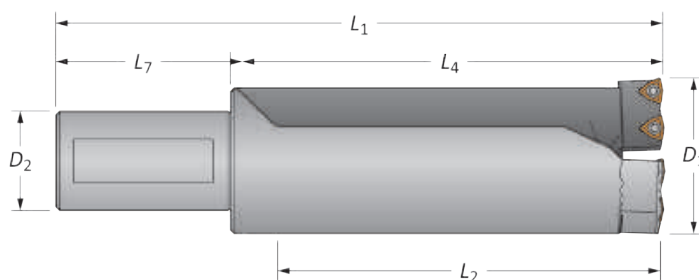

### Straight Shank Metric

Style	Length	D <sub>1</sub> Range	Holder			Shank			Part No.*	Cartridges
			L <sub>2</sub>	L <sub>4</sub>	L <sub>1</sub>	D <sub>2</sub>	L <sub>7</sub>	P <sub>1</sub>		
Standard	2.2xD	61.0 - 66.0	144.9	171.7	241.7	40	70	-	R42X22-40M	C42-...
Standard	3.5xD	61.0 - 66.0	233.8	260.6	330.6	40	70	-	R42X35-40M	C42-...
Standard	4.5xD	61.0 - 66.0	297.3	324.1	394.1	40	70	-	R42X45-40M	C42-...
Stacked Plate	2.2xD	61.0 - 66.0	146.1	172.9	242.9	40	70	-	SP42X22-40M	C42SP-...

\*Holder includes cartridges; however, inserts are sold separately.

A60: 22 - 23

A60: 2 - 4

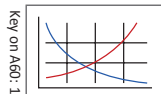

**i** = Imperial (in)  
**m** = Metric (mm)



## Revolution Drill Holders

42 Series | Diameter Range: 2.400" - 2.600" (61.0mm - 66.0mm)

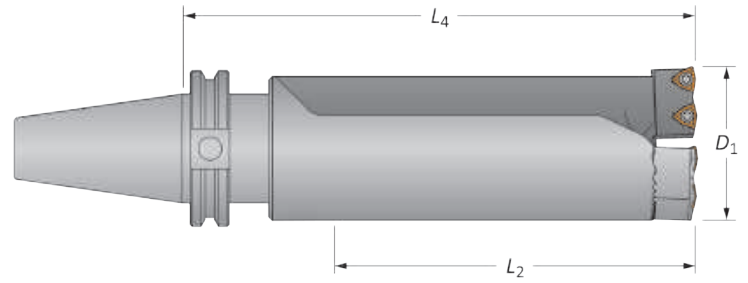

### CV40 Shank

Style	Length	D <sub>1</sub> Range	Holder		Shank	Part No.*	Cartridges
			L <sub>2</sub>	L <sub>4</sub>			
Standard	2.2xD	2.400 - 2.600	5-45/64	8-9/64	CV40	R42X22-CV40	C42-...
Standard	3.5xD	2.400 - 2.600	9-13/64	11-41/64	CV40	R42X35-CV40	C42-...
Standard	4.5xD	2.400 - 2.600	11-45/64	14-9/64	CV40	R42X45-CV40	C42-...
Stacked Plate	2.2xD	2.400 - 2.600	5-3/4	8-3/16	CV40	SP42X22-CV40	C42SP-...

\*Holder includes cartridges; however, inserts are sold separately.

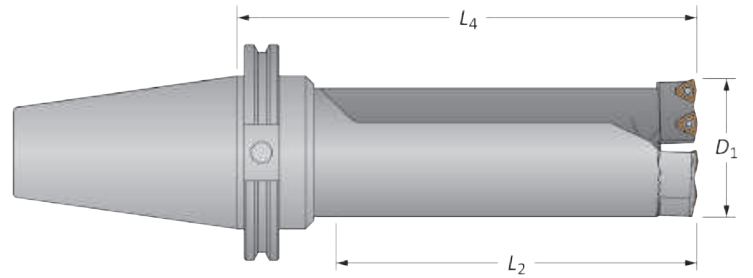

### CV50 Shank

Style	Length	D <sub>1</sub> Range	Holder		Shank	Part No.*	Cartridges
			L <sub>2</sub>	L <sub>4</sub>			
Standard	2.2xD	2.400 - 2.600	5-45/64	8-9/64	CV50	R42X22-CV50	C42-...
Standard	3.5xD	2.400 - 2.600	9-13/64	11-41/64	CV50	R42X35-CV50	C42-...
Standard	4.5xD	2.400 - 2.600	11-45/64	14-9/64	CV50	R42X45-CV50	C42-...
Stacked Plate	2.2xD	2.400 - 2.600	5-3/4	8-3/16	CV50	SP42X22-CV50	C42SP-...

\*Holder includes cartridges; however, inserts are sold separately.

### Cartridges

Holder Part No.	Replacement Cartridges	Qty. Inserts Needed	Mounting Screw	Key Size	Adjusting Screw	Driver
R42...	C42-FIX	2	MS-19M-1	6mm	AS-18T9-1	8T-9
	C42-ADJ	2	MS-19M-1	6mm	AS-18T9-1	8T-9
SP42...	C42SP-FIX	2	MS-19M-1	6mm	AS-18T9-1	8T-9
	C42SP-ADJ	2	MS-19M-1	6mm	AS-18T9-1	8T-9

### IC Inserts

Carbide Grade	Geometry	Part No.			Insert Screws	Driver
		AM300®	AM200®	TiN		
C5 (P35)	Standard	OP-05T308-P	OP-05T308-H	OP-05T308-T	IS-10-1	8T-9
C1 (K35)	Standard	OP-05T308-1P	OP-05T308-1H	OP-05T308-1T	IS-10-1	8T-9
C2 (K25)	Standard	OP-05T308-2P	OP-05T308-2H	-	IS-10-1	8T-9
C5 (P35)	High Rake	OP-05T308-PHR	OP-05T308-HHR	-	IS-10-1	8T-9

A60: 22 - 23

A60: 2 - 4

Mounting screws sold in multiples of 4 | Adjusting screws sold in multiples of 4  
 IC inserts sold in multiples of 10 | Insert screws sold in multiples of 10

ⓘ = Imperial (in)  
 Ⓜ = Metric (mm)

A  
DRILLING  
B  
BORING  
C  
REAMING  
D  
BURNISHING  
E  
THREADING  
X  
SPECIALS

## Revolution Drill Holders

44 Series | Diameter Range: 2.600" - 2.800" (66.0mm - 71.1mm)

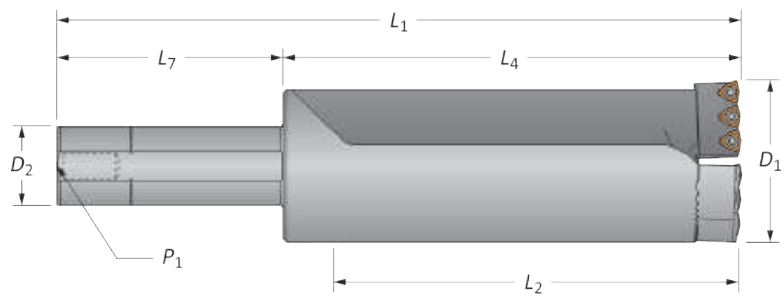

### Straight Shank Imperial

Style	Length	D <sub>1</sub> Range	Holder			Shank			Part No.*	Cartridges
			L <sub>2</sub>	L <sub>4</sub>	L <sub>1</sub>	D <sub>2</sub>	L <sub>7</sub>	P <sub>1</sub>		
Standard	2.2xD	2.600 - 2.800	6-13/64	7-1/2	11-1/2	1-1/2	4	1/4	R44X22-150L	C44-...
Standard	3.5xD	2.600 - 2.800	9-61/64	11-1/4	15-1/4	1-1/2	4	1/4	R44X35-150L	C44-...
Stacked Plate	2.2xD	2.600 - 2.800	6-1/4	7-35/64	11-35/64	1-1/2	4	1/4	SP44X22-150L	C44SP-...

\*Holder includes cartridges; however, inserts are sold separately.

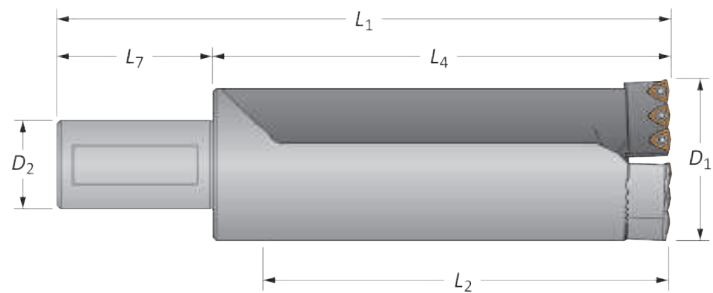

### Straight Shank Metric

Style	Length	D <sub>1</sub> Range	Holder			Shank			Part No.*	Cartridges
			L <sub>2</sub>	L <sub>4</sub>	L <sub>1</sub>	D <sub>2</sub>	L <sub>7</sub>	P <sub>1</sub>		
Standard	2.2xD	66.0 - 71.1	157.6	190.7	260.7	40	70	-	R44X22-40M	C44-...
Standard	3.5xD	66.0 - 71.1	252.9	285.9	355.9	40	70	-	R44X35-40M	C44-...
Stacked Plate	2.2xD	66.0 - 71.1	158.7	191.7	261.7	40	70	-	SP44X22-40M	C44SP-...

\*Holder includes cartridges; however, inserts are sold separately.

A60: 22 - 23

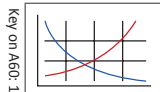

A60: 2 - 4



**i** = Imperial (in)  
**m** = Metric (mm)

## Revolution Drill Holders

44 Series | Diameter Range: 2.600" - 2.800" (66.0mm - 71.1mm)

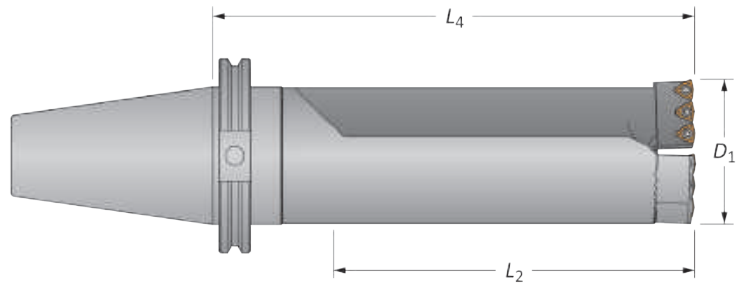

### CV50 Shank

Style	Length	D <sub>1</sub> Range	Holder		Shank	Part No.*	Cartridges
			L <sub>2</sub>	L <sub>4</sub>			
Standard	2.2xD	2.600 - 2.800	6-13/64	8-7/8	CV50	R44X22-CV50	C44-...
Standard	3.5xD	2.600 - 2.800	9-61/64	12-5/8	CV50	R44X35-CV50	C44-...
Stacked Plate	2.2xD	2.600 - 2.800	6-1/4	8-59/64	CV50	SP44X22-CV50	C44SP-...

\*Holder includes cartridges; however, inserts are sold separately.

### Cartridges

Holder Part No.	Replacement Cartridges	Qty. Inserts Needed	Mounting Screw	Key Size	Adjusting Screw	Driver
R44...	C44-FIX	3	MS-19M-1	6mm	AS-18T9-1	8T-9
	C44-ADJ	3	MS-19M-1	6mm	AS-18T9-1	8T-9
SP44...	C44SP-FIX	3	MS-19M-1	6mm	AS-18T9-1	8T-9
	C44SP-ADJ	3	MS-19M-1	6mm	AS-18T9-1	8T-9

### IC Inserts

Carbide Grade	Geometry	Part No.			Insert Screws	Driver
		AM300®	AM200®	TiN		
C5 (P35)	Standard	OP-05T308-P	OP-05T308-H	OP-05T308-T	IS-10-1	8T-9
C1 (K35)	Standard	OP-05T308-1P	OP-05T308-1H	OP-05T308-1T	IS-10-1	8T-9
C2 (K25)	Standard	OP-05T308-2P	OP-05T308-2H	-	IS-10-1	8T-9
C5 (P35)	High Rake	OP-05T308-PHR	OP-05T308-HHR	-	IS-10-1	8T-9

A60: 22 - 23

A60: 2 - 4

Mounting screws sold in multiples of 4 | Adjusting screws sold in multiples of 4  
 IC inserts sold in multiples of 10 | Insert screws sold in multiples of 10

**i** = Imperial (in)  
**m** = Metric (mm)

## Revolution Drill Holders

46 Series | Diameter Range: 2.800" - 3.000" (71.1mm - 76.2mm)

A  
DRILLING

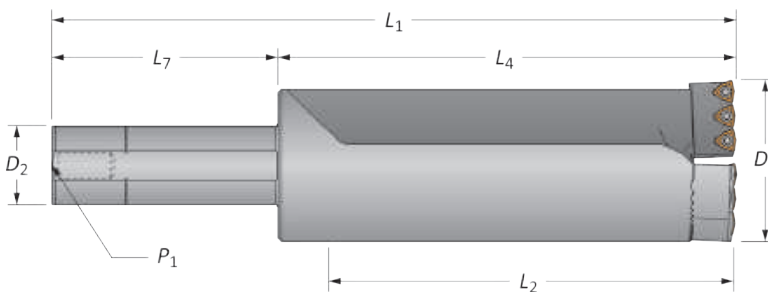

B  
BORING

### Straight Shank Imperial

Style	Length	D <sub>1</sub> Range	Holder			Shank			Part No.*	Cartridges
			L <sub>2</sub>	L <sub>4</sub>	L <sub>1</sub>	D <sub>2</sub>	L <sub>7</sub>	P <sub>1</sub>		
Standard	2.2xD	2.800 - 3.000	6-45/64	8	12	1-1/2	4	1/4	R46X22-150L	C46-...
Standard	3.5xD	2.800 - 3.000	10-29/64	11-3/4	15-3/4	1-1/2	4	1/4	R46X35-150L	C46-...
Stacked Plate	2.2xD	2.800 - 3.000	6-3/4	8-3/64	12-3/64	1-1/2	4	1/4	SP46X22-150L	C46SP-...

\*Holder includes cartridges; however, inserts are sold separately.

C  
REAMING

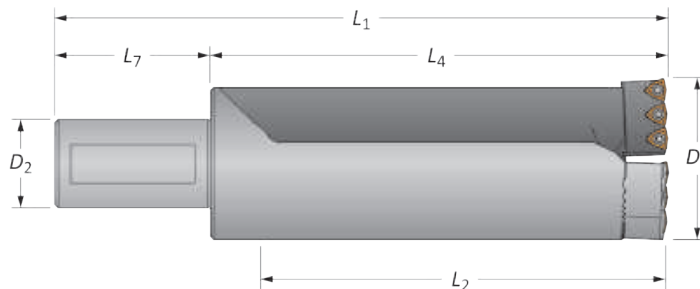

D  
BURNISHING

### Straight Shank Metric

Style	Length	D <sub>1</sub> Range	Holder			Shank			Part No.*	Cartridges
			L <sub>2</sub>	L <sub>4</sub>	L <sub>1</sub>	D <sub>2</sub>	L <sub>7</sub>	P <sub>1</sub>		
Standard	2.2xD	71.1 - 76.2	170.4	203.4	273.4	40	70	-	R46X22-40M	C46-...
Standard	3.5xD	71.1 - 76.2	265.6	298.6	368.6	40	70	-	R46X35-40M	C46-...
Stacked Plate	2.2xD	71.1 - 76.2	171.4	204.4	274.4	40	70	-	SP46X22-40M	C46SP-...

\*Holder includes cartridges; however, inserts are sold separately.

F  
THREADING

X  
SPECIALS

A60: 22 - 23      A60: 2 - 4

**i** = Imperial (in)  
**m** = Metric (mm)





## Revolution Drill Holders

46 Series | Diameter Range: 2.800" - 3.000" (71.1mm - 76.2mm)

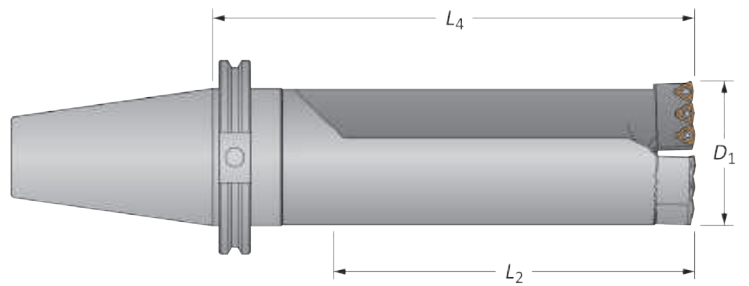

### CV50 Shank

Style	Length	D <sub>1</sub> Range	Holder		Shank	Part No.*	Cartridges
			L <sub>2</sub>	L <sub>4</sub>			
Standard	2.2xD	2.800 - 3.000	6-45/64	9-25/64	CV50	R46X22-CV50	C46-...
Standard	3.5xD	2.800 - 3.000	10-29/64	13-1/8	CV50	R46X35-CV50	C46-...
Stacked Plate	2.2xD	2.800 - 3.000	6-3/4	9-27/64	CV50	SP46X22-CV50	C46SP-...

\*Holder includes cartridges; however, inserts are sold separately.

### Cartridges

Holder Part No.	Replacement Cartridges	Qty. Inserts Needed	Mounting Screw	Key Size	Adjusting Screw	Driver
R46...	C46-FIX	3	MS-21M-1	8mm	AS-18T9-1	8T-9
	C46-ADJ	3	MS-21M-1	8mm	AS-18T9-1	8T-9
SP46...	C46SP-FIX	3	MS-21M-1	8mm	AS-18T9-1	8T-9
	C46SP-ADJ	3	MS-21M-1	8mm	AS-18T9-1	8T-9

### IC Inserts

Carbide Grade	Geometry	Part No.			Insert Screws	Driver
		AM300®	AM200®	TiN		
C5 (P35)	Standard	OP-05T308-P	OP-05T308-H	OP-05T308-T	IS-10-1	8T-9
C1 (K35)	Standard	OP-05T308-1P	OP-05T308-1H	OP-05T308-1T	IS-10-1	8T-9
C2 (K25)	Standard	OP-05T308-2P	OP-05T308-2H	-	IS-10-1	8T-9
C5 (P35)	High Rake	OP-05T308-PHR	OP-05T308-HHR	-	IS-10-1	8T-9

Key on A60: 1

A60: 22 - 23

A60: 2 - 4

Mounting screws sold in multiples of 4 | Adjusting screws sold in multiples of 4  
 IC inserts sold in multiples of 10 | Insert screws sold in multiples of 10

**i** = Imperial (in)  
**m** = Metric (mm)

## Revolution Drill Holders

48 Series | Diameter Range: 3.000" - 3.200" (76.2mm - 81.3mm)

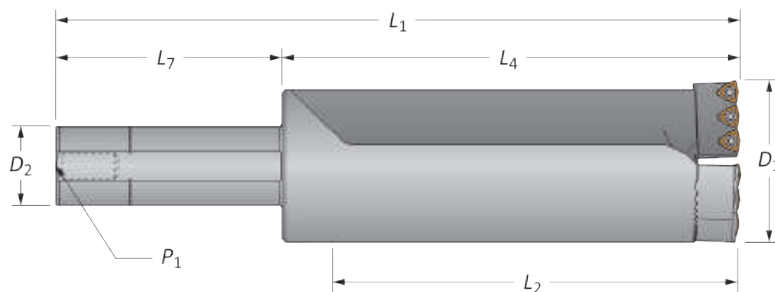

### Straight Shank Imperial

Style	Length	D <sub>1</sub> Range	Holder			Shank			Part No.*	Cartridges
			L <sub>2</sub>	L <sub>4</sub>	L <sub>1</sub>	D <sub>2</sub>	L <sub>7</sub>	P <sub>1</sub>		
Standard	1.0xD	3.000 - 3.200	3-5/32	4-33/64	9-1/64	2	4-1/2	1/4	R48X10-200L	C48-...
Standard	2.5xD	3.000 - 3.200	7-29/32	9-17/64	13-49/64	2	4-1/2	1/4	R48X25-200L	C48-...
Stacked Plate	1.0xD	3.000 - 3.200	3-15/64	4-19/32	9-3/32	2	4-1/2	1/4	SP48X10-200L	C48SP-...
Stacked Plate	2.5xD	3.000 - 3.200	7-63/64	9-11/32	13-27/32	2	4-1/2	1/4	SP48X25-200L	C48SP-...

\*Holder includes cartridges; however, inserts are sold separately.

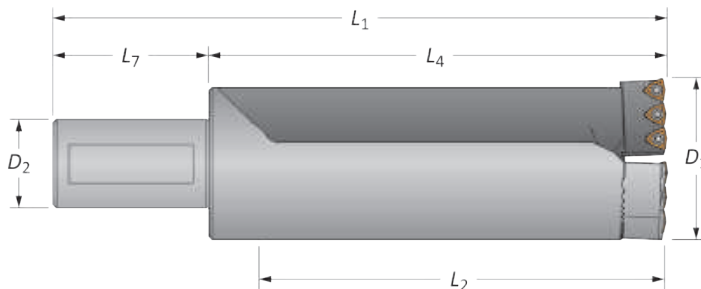

### Straight Shank Metric

Style	Length	D <sub>1</sub> Range	Holder			Shank			Part No.*	Cartridges
			L <sub>2</sub>	L <sub>4</sub>	L <sub>1</sub>	D <sub>2</sub>	L <sub>7</sub>	P <sub>1</sub>		
Standard	1.0xD	76.2 - 81.3	80.2	114.5	194.5	50	80	-	R48X10-50M	C48-...
Standard	2.5xD	76.2 - 81.3	200.9	235.2	315.2	50	80	-	R48X25-50M	C48-...
Stacked Plate	1.0xD	76.2 - 81.3	82.2	116.5	196.5	50	80	-	SP48X10-50M	C48SP-...
Stacked Plate	2.5xD	76.2 - 81.3	202.9	237.2	317.2	50	80	-	SP48X25-50M	C48SP-...

\*Holder includes cartridges; however, inserts are sold separately.

A  
DRILLING  
B  
BORING  
C  
REAMING  
D  
BURNISHING  
E  
THREADING  
X  
SPECIALS

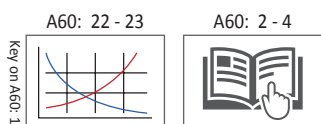

i = Imperial (in)  
m = Metric (mm)



## Revolution Drill Holders

48 Series | Diameter Range: 3.000" - 3.200" (76.2mm - 81.3mm)

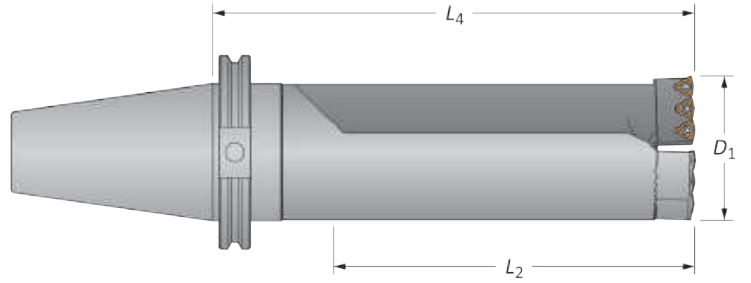

### CV50 Shank

Style	Length	D <sub>1</sub> Range	Holder		Shank	Part No.*	Cartridges
			L <sub>2</sub>	L <sub>4</sub>			
Standard	1.0xD	3.000 - 3.200	3-5/32	5-57/64	CV50	<b>R48X10-CV50</b>	C48-...
Standard	2.5xD	3.000 - 3.200	7-29/32	10-41/64	CV50	<b>R48X25-CV50</b>	C48-...
Stacked Plate	1.0xD	3.000 - 3.200	3-15/64	5-31/32	CV50	<b>SP48X10-CV50</b>	C48SP-...
Stacked Plate	2.5xD	3.000 - 3.200	7-63/64	10-23/32	CV50	<b>SP48X25-CV50</b>	C48SP-...

\*Holder includes cartridges; however, inserts are sold separately.

### Cartridges

Holder Part No.	Replacement Cartridges	Qty. Inserts Needed	Mounting Screw	Key Size	Adjusting Screw	Driver
R48...	C48-FIX	3	MS-21M-1	8mm	AS-18T9-1	8T-9
	C48-ADJ	3	MS-21M-1	8mm	AS-18T9-1	8T-9
SP48...	C48SP-FIX	3	MS-21M-1	8mm	AS-18T9-1	8T-9
	C48SP-ADJ	3	MS-21M-1	8mm	AS-18T9-1	8T-9

### IC Inserts

Carbide Grade	Geometry	Part No.			Insert Screws	Driver
		AM300®	AM200®	TiN		
C5 (P35)	Standard	OP-05T308-P	OP-05T308-H	OP-05T308-T	IS-10-1	8T-9
C1 (K35)	Standard	OP-05T308-1P	OP-05T308-1H	OP-05T308-1T	IS-10-1	8T-9
C2 (K25)	Standard	OP-05T308-2P	OP-05T308-2H	-	IS-10-1	8T-9
C5 (P35)	High Rake	OP-05T308-PHR	OP-05T308-HHR	-	IS-10-1	8T-9

A60: 22 - 23

A60: 2 - 4

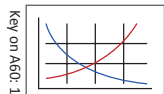

Mounting screws sold in multiples of 4 | Adjusting screws sold in multiples of 4  
 IC inserts sold in multiples of 10 | Insert screws sold in multiples of 10

**i** = Imperial (in)  
**m** = Metric (mm)



## Revolution Drill Holders

52 Series | Diameter Range: 3.200" - 3.400" (81.3mm - 86.4mm)

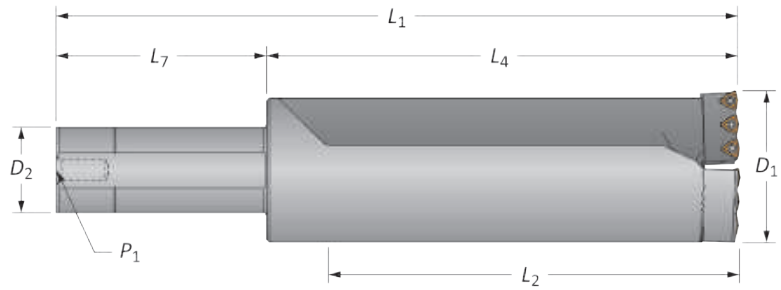

### Straight Shank Imperial

Style	Length	$D_1$ Range	Holder			Shank			Part No.*	Cartridges
			$L_2$	$L_4$	$L_1$	$D_2$	$L_7$	$P_1$		
Standard	1.0xD	3.200 - 3.400	3-27/64	5-1/64	9-33/64	2	4-1/2	1/4	<b>R52X10-200L</b>	C52-...
Standard	2.5xD	3.200 - 3.400	8-27/64	10-1/64	14-33/64	2	4-1/2	1/4	<b>R52X25-200L</b>	C52-...
Stacked Plate	1.0xD	3.200 - 3.400	3-31/64	5-5/64	9-37/64	2	4-1/2	1/4	<b>SP52X10-200L</b>	C52SP-...
Stacked Plate	2.5xD	3.200 - 3.400	8-31/64	10-5/64	14-37/64	2	4-1/2	1/4	<b>SP52X25-200L</b>	C52SP-...

\*Holder includes cartridges; however, inserts are sold separately.

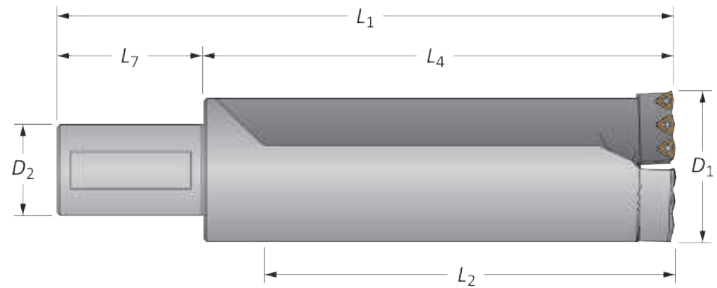

### Straight Shank Metric

Style	Length	$D_1$ Range	Holder			Shank			Part No.*	Cartridges
			$L_2$	$L_4$	$L_1$	$D_2$	$L_7$	$P_1$		
Standard	1.0xD	81.3 - 86.4	86.7	127.2	207.2	50	80	-	<b>R52X10-50M</b>	C52-...
Standard	2.5xD	81.3 - 86.4	213.7	254.2	334.2	50	80	-	<b>R52X25-50M</b>	C52-...
Stacked Plate	1.0xD	81.3 - 86.4	88.6	129.1	209.1	50	80	-	<b>SP52X10-50M</b>	C52SP-...
Stacked Plate	2.5xD	81.3 - 86.4	215.6	256.1	336.1	50	80	-	<b>SP52X25-50M</b>	C52SP-...

\*Holder includes cartridges; however, inserts are sold separately.

A60: 22 - 23

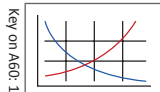

A60: 2 - 4



**i** = Imperial (in)  
**m** = Metric (mm)



## Revolution Drill Holders

52 Series | Diameter Range: 3.200" - 3.400" (81.3mm - 86.4mm)

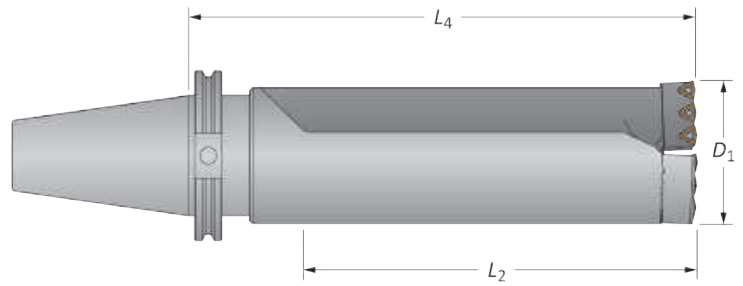

### CV50 Shank

Style	Length	D <sub>1</sub> Range	Holder		Shank	Part No.*	Cartridges
			L <sub>2</sub>	L <sub>4</sub>			
Standard	1.0xD	3.200 - 3.400	3-27/64	6-25/64	CV50	R52X10-CV50	C52-...
Standard	2.5xD	3.200 - 3.400	8-27/64	11-25/64	CV50	R52X25-CV50	C52-...
Stacked Plate	1.0xD	3.200 - 3.400	3-31/64	6-29/64	CV50	SP52X10-CV50	C52SP-...
Stacked Plate	2.5xD	3.200 - 3.400	8-31/64	11-29/64	CV50	SP52X25-CV50	C52SP-...

\*Holder includes cartridges; however, inserts are sold separately.

### Cartridges

Holder Part No.	Replacement Cartridges	Qty. Inserts Needed	Mounting Screw	Key Size	Adjusting Screw	Driver
R52...	C52-FIX	3	MS-19M-1	6mm	AS-18T9-1	8T-9
	C52-ADJ	3	MS-19M-1	6mm	AS-18T9-1	8T-9
SP52...	C52SP-FIX	3	MS-19M-1	6mm	AS-18T9-1	8T-9
	C52SP-ADJ	3	MS-19M-1	6mm	AS-18T9-1	8T-9

### IC Inserts

Carbide Grade	Geometry	Part No.			Insert Screws	Driver
		AM300®	AM200®	TiN		
C5 (P35)	Standard	OP-05T308-P	OP-05T308-H	OP-05T308-T	IS-10-1	8T-9
C1 (K35)	Standard	OP-05T308-1P	OP-05T308-1H	OP-05T308-1T	IS-10-1	8T-9
C2 (K25)	Standard	OP-05T308-2P	OP-05T308-2H	-	IS-10-1	8T-9
C5 (P35)	High Rake	OP-05T308-PHR	OP-05T308-HHR	-	IS-10-1	8T-9

Key on A60-1

A60: 22 - 23

A60: 2 - 4

Mounting screws sold in multiples of 4 | Adjusting screws sold in multiples of 4  
 IC inserts sold in multiples of 10 | Insert screws sold in multiples of 10

ⓘ = Imperial (in)  
 ⓘ = Metric (mm)



## Revolution Drill Holders

54 Series | Diameter Range: 3.400" - 3.600" (86.4mm - 91.4mm)

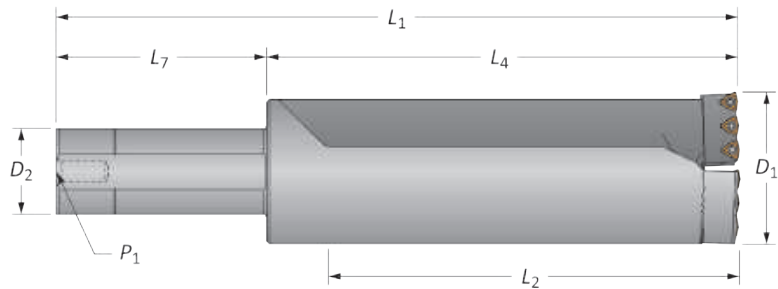

### Straight Shank Imperial

Style	Length	D <sub>1</sub> Range	Holder			Shank			Part No.*	Cartridges
			L <sub>2</sub>	L <sub>4</sub>	L <sub>1</sub>	D <sub>2</sub>	L <sub>7</sub>	P <sub>1</sub>		
Standard	1.0xD	3.400 - 3.600	3-21/32	5-17/64	9-49/64	2	4-1/2	1/4	R54X10-200L	C54-...
Standard	2.5xD	3.400 - 3.600	8-29/32	10-33/64	15-1/64	2	4-1/2	1/4	R54X25-200L	C54-...
Stacked Plate	1.0xD	3.400 - 3.600	3-23/32	5-21/64	9-53/64	2	4-1/2	1/4	SP54X10-200L	C54SP-...
Stacked Plate	2.5xD	3.400 - 3.600	8-31/32	10-37/64	15-5/64	2	4-1/2	1/4	SP54X25-200L	C54SP-...

\*Holder includes cartridges; however, inserts are sold separately.

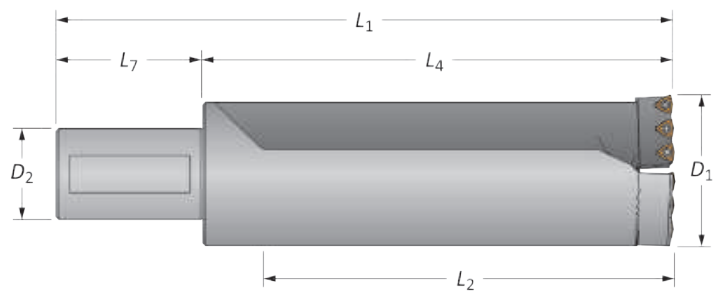

### Straight Shank Metric

Style	Length	D <sub>1</sub> Range	Holder			Shank			Part No.*	Cartridges
			L <sub>2</sub>	L <sub>4</sub>	L <sub>1</sub>	D <sub>2</sub>	L <sub>7</sub>	P <sub>1</sub>		
Standard	1.0xD	86.4 - 91.4	92.9	133.6	213.6	50	80	-	R54X10-50M	C54-...
Standard	2.5xD	86.4 - 91.4	226.3	266.9	346.9	50	80	-	R54X25-50M	C54-...
Stacked Plate	1.0xD	86.4 - 91.4	94.5	135.1	215.1	50	80	-	SP54X10-50M	C54SP-...
Stacked Plate	2.5xD	86.4 - 91.4	227.8	268.5	348.5	50	80	-	SP54X25-50M	C54SP-...

\*Holder includes cartridges; however, inserts are sold separately.

A60: 22 - 23

A60: 2 - 4

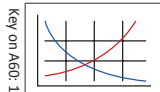

**i** = Imperial (in)  
**m** = Metric (mm)



## Revolution Drill Holders

54 Series | Diameter Range: 3.400" - 3.600" (86.4mm - 91.4mm)

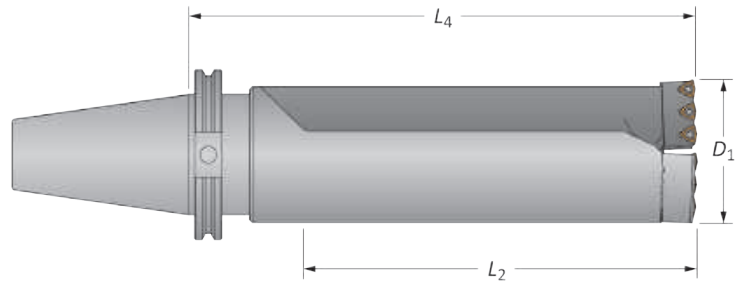

### CV50 Shank

Style	Length	D <sub>1</sub> Range	Holder		Shank	Part No.*	Cartridges	
			L <sub>2</sub>	L <sub>4</sub>				
i	Standard	1.0xD	3.400 - 3.600	3-21/32	6-41/64	CV50	R54X10-CV50	C54-...
	Standard	2.5xD	3.400 - 3.600	8-29/32	11-57/64	CV50	R54X25-CV50	C54-...
	Stacked Plate	1.0xD	3.400 - 3.600	3-23/32	6-11/16	CV50	SP54X10-CV50	C54SP-...
	Stacked Plate	2.5xD	3.400 - 3.600	8-31/32	11-15/16	CV50	SP54X25-CV50	C54SP-...

\*Holder includes cartridges; however, inserts are sold separately.

### Cartridges

Holder Part No.	Replacement Cartridges	Qty. Inserts Needed	Mounting Screw	Key Size	Adjusting Screw	Driver
R54...	C54-FIX	3	MS-19M-1	6mm	AS-18T9-1	8T-9
	C54-ADJ	3	MS-19M-1	6mm	AS-18T9-1	8T-9
SP54...	C54SP-FIX	3	MS-19M-1	6mm	AS-18T9-1	8T-9
	C54SP-ADJ	3	MS-19M-1	6mm	AS-18T9-1	8T-9

### IC Inserts

Carbide Grade	Geometry	Part No.			Insert Screws	Driver
		AM300®	AM200®	TiN		
C5 (P35)	Standard	OP-05T308-P	OP-05T308-H	OP-05T308-T	IS-10-1	8T-9
C1 (K35)	Standard	OP-05T308-1P	OP-05T308-1H	OP-05T308-1T	IS-10-1	8T-9
C2 (K25)	Standard	OP-05T308-2P	OP-05T308-2H	-	IS-10-1	8T-9
C5 (P35)	High Rake	OP-05T308-PHR	OP-05T308-HHR	-	IS-10-1	8T-9

A60: 22 - 23

A60: 2 - 4

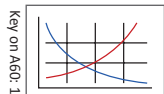

Mounting screws sold in multiples of 4 | Adjusting screws sold in multiples of 4  
 IC inserts sold in multiples of 10 | Insert screws sold in multiples of 10

i = Imperial (in)  
 m = Metric (mm)



## Revolution Drill Holders

56 Series | Diameter Range: 3.600" - 3.800" (91.4mm - 96.5mm)

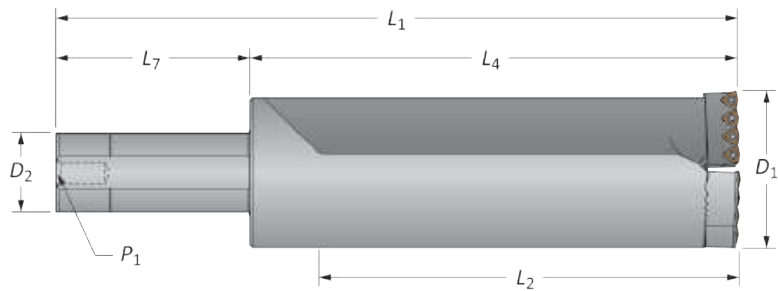

### Straight Shank Imperial

Style	Length	D <sub>1</sub> Range	Holder			Shank			Part No.*	Cartridges
			L <sub>2</sub>	L <sub>4</sub>	L <sub>1</sub>	D <sub>2</sub>	L <sub>7</sub>	P <sub>1</sub>		
Standard	1.0xD	3.600 - 3.800	3-7/8	5-3/4	10-1/4	2	4-1/2	1/4	R56X10-200L	C56-...
Standard	2.5xD	3.600 - 3.800	9-3/8	11-1/4	15-3/4	2	4-1/2	1/4	R56X25-200L	C56-...
Stacked Plate	1.0xD	3.600 - 3.800	3-15/16	5-13/16	10-5/16	2	4-1/2	1/4	SP56X10-200L	C56SP-...
Stacked Plate	2.5xD	3.600 - 3.800	9-7/16	11-5/16	15-13/16	2	4-1/2	1/4	SP56X25-200L	C56SP-...

\*Holder includes cartridges; however, inserts are sold separately.

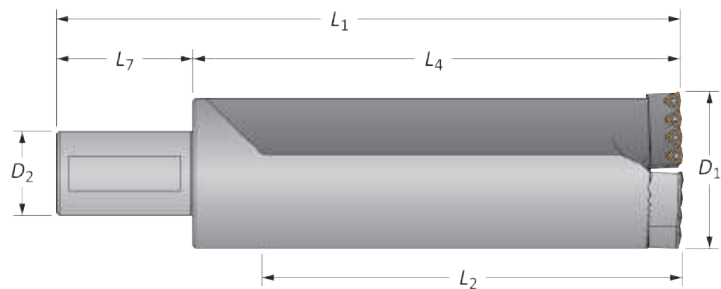

### Straight Shank Metric

Style	Length	D <sub>1</sub> Range	Holder			Shank			Part No.*	Cartridges
			L <sub>2</sub>	L <sub>4</sub>	L <sub>1</sub>	D <sub>2</sub>	L <sub>7</sub>	P <sub>1</sub>		
Standard	1.0xD	91.4 - 96.5	98.6	146.2	226.2	50	80	-	R56X10-50M	C56-...
Standard	2.5xD	91.4 - 96.5	238.3	285.9	365.9	50	80	-	R56X25-50M	C56-...
Stacked Plate	1.0xD	91.4 - 96.5	99.9	147.6	227.6	50	80	-	SP56X10-50M	C56SP-...
Stacked Plate	2.5xD	91.4 - 96.5	239.6	287.3	367.3	50	80	-	SP56X25-50M	C56SP-...

\*Holder includes cartridges; however, inserts are sold separately.

A60: 22 - 23

A60: 2 - 4

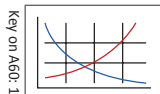

**i** = Imperial (in)  
**m** = Metric (mm)





## Revolution Drill Holders

56 Series | Diameter Range: 3.600" - 3.800" (91.4mm - 96.5mm)

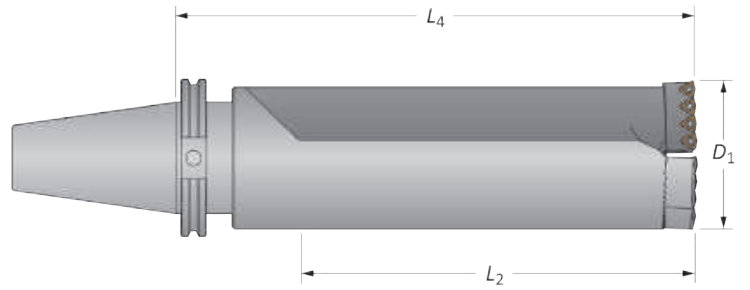

### CV50 Shank

Style	Length	D <sub>1</sub> Range	Holder		Shank	Part No.*	Cartridges
			L <sub>2</sub>	L <sub>4</sub>			
Standard	1.0xD	3.600 - 3.800	3-7/8	7-1/8	CV50	R56X10-CV50	C56-...
Standard	2.5xD	3.600 - 3.800	9-3/8	12-5/8	CV50	R56X25-CV50	C56-...
Stacked Plate	1.0xD	3.600 - 3.800	3-15/16	7-3/16	CV50	SP56X10-CV50	C56SP-...
Stacked Plate	2.5xD	3.600 - 3.800	9-7/16	12-11/16	CV50	SP56X25-CV50	C56SP-...

\*Holder includes cartridges; however, inserts are sold separately.

### Cartridges

Holder Part No.	Replacement Cartridges	Qty. Inserts Needed	Mounting Screw	Key Size	Adjusting Screw	Driver
R56...	C56-FIX	4	MS-21M-1	8mm	AS-18T9-1	8T-9
	C56-ADJ	4	MS-21M-1	8mm	AS-18T9-1	8T-9
SP56...	C56SP-FIX	4	MS-21M-1	8mm	AS-18T9-1	8T-9
	C56SP-ADJ	4	MS-21M-1	8mm	AS-18T9-1	8T-9

### IC Inserts

Carbide Grade	Geometry	Part No.			Insert Screws	Driver
		AM300®	AM200®	TiN		
C5 (P35)	Standard	OP-05T308-P	OP-05T308-H	OP-05T308-T	IS-10-1	8T-9
C1 (K35)	Standard	OP-05T308-1P	OP-05T308-1H	OP-05T308-1T	IS-10-1	8T-9
C2 (K25)	Standard	OP-05T308-2P	OP-05T308-2H	-	IS-10-1	8T-9
C5 (P35)	High Rake	OP-05T308-PHR	OP-05T308-HHR	-	IS-10-1	8T-9

A60: 22 - 23

A60: 2 - 4

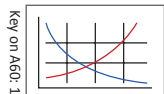

Mounting screws sold in multiples of 4 | Adjusting screws sold in multiples of 4  
 IC inserts sold in multiples of 10 | Insert screws sold in multiples of 10

**i** = Imperial (in)  
**m** = Metric (mm)



## Revolution Drill Holders

58 Series | Diameter Range: 3.800" - 4.000" (96.5mm - 101.6mm)

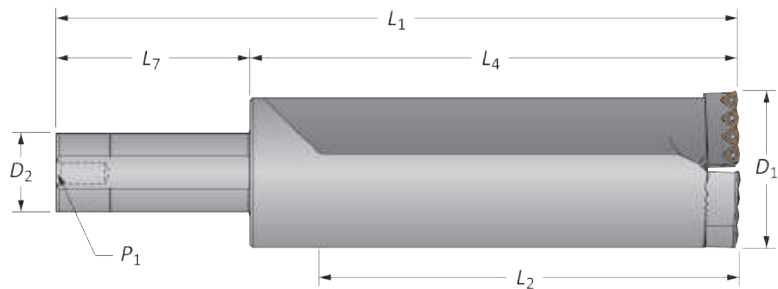

### Straight Shank Imperial

Style	Length	D <sub>1</sub> Range	Holder			Shank			Part No.*	Cartridges
			L <sub>2</sub>	L <sub>4</sub>	L <sub>1</sub>	D <sub>2</sub>	L <sub>7</sub>	P <sub>1</sub>		
Standard	1.0xD	3.800 - 4.000	3-7/8	5-3/4	10-1/4	2	4-1/2	1/4	R58X10-200L	C58-...
Standard	2.5xD	3.800 - 4.000	9-7/8	11-3/4	16-1/4	2	4-1/2	1/4	R58X25-200L	C58-...
Stacked Plate	1.0xD	3.800 - 4.000	3-15/16	5-13/16	10-5/16	2	4-1/2	1/4	SP58X10-200L	C58SP-...
Stacked Plate	2.5xD	3.800 - 4.000	9-15/16	11-13/16	16-5/16	2	4-1/2	1/4	SP58X25-200L	C58SP-...

\*Holder includes cartridges; however, inserts are sold separately.

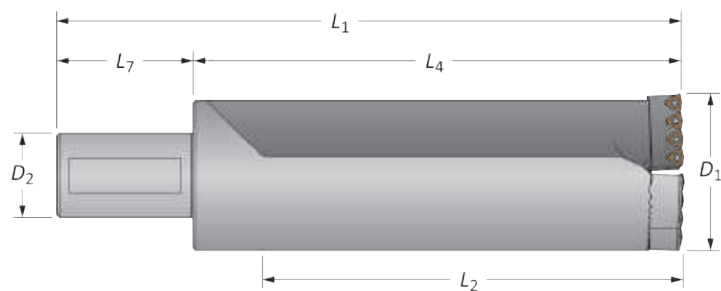

### Straight Shank Metric

Style	Length	D <sub>1</sub> Range	Holder			Shank			Part No.*	Cartridges
			L <sub>2</sub>	L <sub>4</sub>	L <sub>1</sub>	D <sub>2</sub>	L <sub>7</sub>	P <sub>1</sub>		
Standard	1.0xD	96.5 - 101.6	98.6	146.2	226.2	50	80	-	R58X10-50M	C58-...
Standard	2.5xD	96.5 - 101.6	251.0	298.6	378.6	50	80	-	R58X25-50M	C58-...
Stacked Plate	1.0xD	96.5 - 101.6	99.8	147.4	227.4	50	80	-	SP58X10-50M	C58SP-...
Stacked Plate	2.5xD	96.5 - 101.6	252.2	299.8	379.8	50	80	-	SP58X25-50M	C58SP-...

\*Holder includes cartridges; however, inserts are sold separately.

A60: 22 - 23

A60: 2 - 4

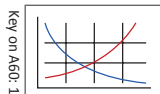

**i** = Imperial (in)  
**m** = Metric (mm)



## Revolution Drill Holders

58 Series | Diameter Range: 3.800" - 4.000" (96.5mm - 101.6mm)

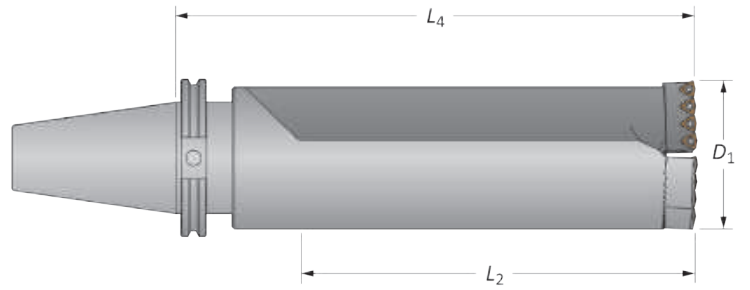

### CV50 Shank

Style	Length	D <sub>1</sub> Range	Holder		Shank	Part No.*	Cartridges
			L <sub>2</sub>	L <sub>4</sub>			
Standard	1.0xD	3.800 - 4.000	3-7/8	7-1/8	CV50	R58X10-CV50	C58-...
Standard	2.5xD	3.800 - 4.000	9-7/8	13-1/8	CV50	R58X25-CV50	C58-...
Stacked Plate	1.0xD	3.800 - 4.000	3-15/16	7-3/16	CV50	SP58X10-CV50	C58SP-...
Stacked Plate	2.5xD	3.800 - 4.000	9-15/16	13-3/16	CV50	SP58X25-CV50	C58SP-...

\*Holder includes cartridges; however, inserts are sold separately.

### Cartridges

Holder Part No.	Replacement Cartridges	Qty. Inserts Needed	Mounting Screw	Key Size	Adjusting Screw	Driver
R58...	C58-FIX	4	MS-21M-1	8mm	AS-18T9-1	8T-9
	C58-ADJ	4	MS-21M-1	8mm	AS-18T9-1	8T-9
SP58...	C58SP-FIX	4	MS-21M-1	8mm	AS-18T9-1	8T-9
	C58SP-ADJ	4	MS-21M-1	8mm	AS-18T9-1	8T-9

### IC Inserts

Carbide Grade	Geometry	Part No.			Insert Screws	Driver
		AM300®	AM200®	TiN		
C5 (P35)	Standard	OP-05T308-P	OP-05T308-H	OP-05T308-T	IS-10-1	8T-9
C1 (K35)	Standard	OP-05T308-1P	OP-05T308-1H	OP-05T308-1T	IS-10-1	8T-9
C2 (K25)	Standard	OP-05T308-2P	OP-05T308-2H	-	IS-10-1	8T-9
C5 (P35)	High Rake	OP-05T308-PHR	OP-05T308-HHR	-	IS-10-1	8T-9

A60: 22 - 23

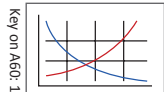

A60: 2 - 4



Mounting screws sold in multiples of 4 | Adjusting screws sold in multiples of 4  
 IC inserts sold in multiples of 10 | Insert screws sold in multiples of 10

**i** = Imperial (in)  
**m** = Metric (mm)

## Recommended Cutting Data | Imperial (inch)

ISO	Material	Hardness (BHN)	Speed (SFM)			Feed Rate (IPR)
			 AM300®	 AM200®	 TiN	
P	<b>Free Machining Steel</b> 1118, 1215, 12L14, etc.	100 - 250	900 - 1300	850 - 1200	700 - 900	.0035 - .007
	<b>Low Carbon Steel</b> 1010, 1020, 1025, 1522, 1144, etc.	85 - 275	850 - 1250	800 - 1150	650 - 850	.003 - .0065
	<b>Medium Carbon Steel</b> 1030, 1040, 1050, 1527, 1140, 1151, etc.	125 - 325	800 - 1050	750 - 950	600 - 850	.0035 - .0065
	<b>Alloy Steel</b> 4140, 5140, 8640, etc.	125 - 375	750 - 1000	700 - 900	600 - 850	.0035 - .0065
	<b>High Strength Alloy</b> 4340, 4330V, 300M, etc.	225 - 400	600 - 850	550 - 750	400 - 650	.003 - .005
	<b>Structural Steel</b> A36, A285, A516, etc.	100 - 350	850 - 1050	800 - 950	650 - 850	.003 - .0065
	<b>Tool Steel</b> H-13, H-21, A-4, O-2, S-3, etc.	150 - 250	400 - 800	350 - 700	250 - 650	.0025 - .005
S	<b>High Temp Alloy</b> Hastelloy B, Inconel 600, etc.	140 - 310	250 - 450	250 - 350	150 - 300	.0025 - .005
M	<b>Stainless Steel 400 Series</b> 416, 420, etc.	185 - 350	600 - 850	550 - 750	400 - 650	.003 - .006
	<b>Stainless Steel 300 Series</b> 304, 316, 17-4PH, etc.	135 - 275	600 - 850	550 - 750	400 - 650	.003 - .006
	<b>Super Duplex Stainless Steel</b>	135 - 275	500 - 750	450 - 650	300 - 550	.002 - .005
K	<b>Nodular, Grey, Ductile Cast Iron</b>	120 - 320	700 - 900	650 - 800	500 - 700	.004 - .008
N	<b>Cast Aluminum</b>	30 - 180	1250 - 1650	1200 - 1550	950 - 1100	.006 - .012
	<b>Wrought Aluminum</b>	30 - 180	1250 - 1650	1200 - 1550	950 - 1100	.006 - .012
	<b>Brass</b>	30 - 100	950 - 1350	900 - 1250	750 - 1100	.005 - .009

### Material Constants

Type of Material	Hardness (BHN)	K <sub>m</sub> (lbs/in <sup>2</sup> )
Free Machining Steel	100 - 250	0.75
Low Carbon Steel	85 - 275	0.85
Medium Carbon Steel	125 - 325	0.90
Alloy Steel	125 - 375	1.00
High Strength Steel	225 - 400	1.15
Structural Steel	100 - 350	1.00
Tool Steel	150 - 250	0.90
High Temperature Alloy	140 - 310	1.44
Titanium Alloy	140 - 310	0.72
Aerospace Alloy	185 - 350	0.70
Stainless Steel 400 Series	185 - 350	1.08
Stainless Steel 300 Series	135 - 275	0.94
Super Duplex Stainless Steel	135 - 275	0.94
Wear Plate	400 - 600	1.60
Hardened Steel	300 - 500	1.40
Nodular, Ductile Cast Iron	120 - 320	0.65
Grey Cast Iron	120 - 320	0.75
Cast Aluminum	30 - 180	0.40
Wrought Aluminum	30 - 180	0.40
Aluminum Bronze	100 - 250	0.50
Brass	100	0.35
Copper	60	0.30



### Formulas

1.	<b>RPM</b> = $(3.82 \cdot \text{SFM}) / \text{DIA}$ where: RPM = revolutions per minute (rev/min) SFM = speed (ft/min) DIA = diameter of drill (inch)
2.	<b>HP</b> = $(0.6676 \cdot \text{DIA}^2 \cdot \text{IPR} \cdot \text{RPM} \cdot K_m) / 0.80$ where: Tool Power = tool power (HP) DIA = diameter of drill (inch) IPR = feed rate (in/rev) RPM = revolutions per minute (rev/min) K <sub>m</sub> = specific cutting energy (lbs/in <sup>2</sup> ) machine efficiency (using 0.80 as constant)
3.	<b>Thrust</b> = $148,500 \cdot \text{IPR} \cdot \text{DIA} \cdot K_m$ where: Thrust = axial thrust (lbs) IPR = feed rate (in/rev) DIA = diameter of drill (inch) K <sub>m</sub> = specific cutting energy (lbs/in <sup>2</sup> )
5.	<b>Torque</b> = $(\text{HP} \cdot 5252) / \text{RPM}$ where: Torque = torque (ft/lbs) HP = tool power (HP) RPM = revolutions per minute (rev/min)

The table and equations on this page are found in the *Machinery's Handbook*. Permission to simplify and print the equations is granted by the Editor of the *Machinery's Handbook*.

**IMPORTANT:** The speeds and feeds listed above are considered a general starting point for all applications. Factory technical assistance is available for your specific applications through our Application Engineering department.

Recommended Cutting Data | Metric (mm)

ISO	Material	Hardness (BHN)	Speed (M/min)			Feed Rate (mm/rev)
			 AM300®	 AM200®	 TiN	
P	Free Machining Steel 1118, 1215, 12L14, etc.	100 - 250	274 - 396	259 - 366	213 - 274	0.09 - 0.18
	Low Carbon Steel 1010, 1020, 1025, 1522, 1144, etc.	85 - 275	259 - 381	244 - 351	198 - 259	0.08 - 0.17
	Medium Carbon Steel 1030, 1040, 1050, 1527, 1140, 1151, etc.	125 - 325	244 - 320	229 - 290	183 - 259	0.09 - 0.17
	Alloy Steel 4140, 5140, 8640, etc.	125 - 375	229 - 305	213 - 274	183 - 259	0.09 - 0.17
	High Strength Alloy 4340, 4330V, 300M, etc.	225 - 400	183 - 259	168 - 229	122 - 198	0.08 - 0.13
	Structural Steel A36, A285, A516, etc.	100 - 350	259 - 320	244 - 290	198 - 259	0.08 - 0.17
	Tool Steel H-13, H-21, A-4, O-2, S-3, etc.	150 - 250	122 - 244	107 - 213	76 - 198	0.06 - 0.13
S	High Temp Alloy Hastelloy B, Inconel 600, etc.	140 - 310	76 - 137	76 - 107	46 - 91	0.06 - 0.11
M	Stainless Steel 400 Series 416, 420, etc.	185 - 350	183 - 259	168 - 229	122 - 198	0.08 - 0.15
	Stainless Steel 300 Series 304, 316, 17-4PH, etc.	135 - 275	183 - 259	168 - 229	122 - 198	0.08 - 0.15
	Super Duplex Stainless Steel	135 - 275	152 - 228	137 - 198	91 - 152	0.05 - 0.12
K	Nodular, Grey, Ductile Cast Iron	120 - 320	213 - 274	198 - 244	152 - 213	0.10 - 0.20
N	Cast Aluminum	30 - 180	381 - 503	381 - 472	290 - 335	0.15 - 0.30
	Wrought Aluminum	30 - 180	381 - 503	381 - 472	290 - 335	0.15 - 0.30
	Brass	30 - 100	290 - 411	274 - 381	229 - 335	0.13 - 0.23

Material Constants

Type of Material	Hardness (BHN)	K <sub>m</sub> (lbs/in <sup>2</sup> )
Free Machining Steel	100 - 250	5.17
Low Carbon Steel	85 - 275	5.86
Medium Carbon Steel	125 - 325	6.21
Alloy Steel	125 - 375	6.90
High Strength Steel	225 - 400	7.93
Structural Steel	100 - 350	6.90
Tool Steel	150 - 250	6.21
High Temperature Alloy	140 - 310	9.93
Titanium Alloy	140 - 310	4.97
Aerospace Alloy	185 - 350	4.48
Stainless Steel 400 Series	185 - 350	7.45
Stainless Steel 300 Series	135 - 275	6.48
Super Duplex Stainless Steel	135 - 275	6.48
Wear Plate	400 - 600	11.04
Hardened Steel	300 - 500	9.66
Nodular, Ductile Cast Iron	120 - 320	4.48
Grey Cast Iron	120 - 320	5.17
Cast Aluminum	30 - 180	2.76
Wrought Aluminum	30 - 180	2.76
Aluminum Bronze	100 - 250	3.45
Brass	100	2.41
Copper	60	2.07

Formulas

1. <b>RPM</b>	<b>= (318.31 • M/min) / DIA</b> where: RPM = revolutions per minute (rev/min) M/min = speed (M/min) DIA = diameter of drill (mm)
2. <b>kW</b>	<b>= (DIA<sup>2</sup> • mm/rev • RPM • K<sub>m</sub>) / 181,018</b> where: kW = tool power (kW) DIA = diameter of drill (mm) mm/rev = feed rate (mm/rev) RPM = revolutions per minute (rev/min) K <sub>m</sub> = specific cutting energy (kPa) machine efficiency (using 181,018 as constant)
3. <b>Thrust</b>	<b>= 148.78 • mm/rev • DIA • K<sub>m</sub></b> where: Thrust = axial thrust (N) mm/rev = feed rate (mm/rev) DIA = diameter of drill (mm) K <sub>m</sub> = specific cutting energy (kPa)
5. <b>Torque</b>	<b>= (kW • 9549.3) / RPM</b> where: Torque = torque (Nm) HP = tool power (kW) RPM = revolutions per minute (rev/min)

The table and equations on this page are found in the *Machinery's Handbook*. Permission to simplify and print the equations is granted by the Editor of the *Machinery's Handbook*.

**IMPORTANT:** The speeds and feeds listed above are considered a general starting point for all applications. Factory technical assistance is available for your specific applications through our Application Engineering department.

A  
DRILLING  
B  
BORING  
C  
REAMING  
D  
BURNISHING  
E  
THREADING  
X  
SPECIALS



SECTION

---

# A70

---

Opening Drill®

# Opening Drill®

Large Diameter Replaceable IC Insert Drilling System

► Diameter Range: 2.000" - 5.620" (50.8mm - 142.8mm)



## Need larger holes? No problem.

The Opening Drill is an extremely effective tool designed to enlarge existing holes. It is available in nine different shank styles: Straight, ABS 63, CAT V40, CAT V50, HSK 63A/C, HSK 100A/C, BT 40, BT 50, and DIN50.

In a *single* operation, an existing hole can be opened and large amounts of material can be removed. The insert design reduces chip size and improves evacuation. Also, inventory and cost are reduced by the adjustable diameters.

Excellent chip control	Improves hole quality and surface finish	Provides maximum durability and stability
------------------------	--	---

## Applicable Industries



Aerospace



Agriculture



Automotive



Firearms



General Machining



Oil & Gas



Renewable Energy

Your safety and the safety of others is very important. This catalog contains important safety messages. Always read and follow all safety precautions.



This triangle is a safety hazard symbol. It alerts you to potential safety hazards that can cause tool failure and serious injury.

When you see this symbol in the catalog, look for a related safety message that may be near this triangle or referred to in the nearby text.

There are safety signal words also used in the catalog. Safety messages follow these words.

### **WARNING**

**WARNING** (shown above) means that failure to follow the precautions in this message could result in tool failure and serious injury.

**NOTICE** means that failure to follow the precautions in this message could result in damage to the tool or machine but not result in personal injury.

**NOTE** and **IMPORTANT** are also used. These are important that you read and follow but are not safety-related.

Visit [www.alliedmachine.com](http://www.alliedmachine.com) for the most up-to-date information and procedures.



**Reference Icons**

The following icons will appear throughout the catalog to help you navigate between products.



**Setup / Assembly Information**

Detailed instructions and information regarding the corresponding part(s)

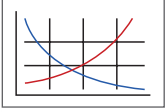

**Recommended Cutting Data**

Speed and feed recommendations for optimum and safe drilling

Series	Diameter Range	
	Imperial (inch)	Metric (mm)
OP1	2.00 - 2.50	50.8 - 63.5
OP2	2.50 - 3.00	63.5 - 76.2
OP3	3.00 - 4.12	76.2 - 104.7
OP4	4.12 - 5.62	104.7 - 142.8

**Introduction Information**

Product Overview . . . . . 2  
 Set-up Instructions . . . . . 3  
 Product Nomenclature. . . . . 4 - 5

**Drill Shank Style**

Straight Imperial . . . . . 6  
 Straight Metric . . . . . 7  
     CAT40 . . . . . 8  
     CAT50 . . . . . 9  
     BT40. . . . . 10  
     BT50. . . . . 11  
     HSK63 . . . . . 12  
     HSK100 . . . . . 13  
     ABS63 . . . . . 14  
     DIN50 . . . . . 15

**Recommended Cutting Data**

Imperial (inch) . . . . . 16 - 17  
 Metric (mm) . . . . . 18 - 19

## Product Overview

### Features

- Can be used as a rotating or stationary tool
- Can be used in rough boring operations
- Available in multiple different shanks (see chart below)
- Smooth cutting action and quiet operations in lathes and mills
- Special lengths, diameters, and shanks are available upon request

### Advantages

- Opens an existing hole in a single operation
- Ignores core shifts up to 1/8" (3.175mm) providing straight and true holes without the need for boring
- Allows for large amounts of material removal
- Unique design enables larger holes to be made on low horsepower machines
- Replaceable cartridges protect your investment
- Adjustable diameters reduce inventory and cost

### Shank Options



AM300°



AM200°



TiN



2 Inserts  
(OP1 - OP3 series)



3 Inserts  
(OP4 series)

### Insert Application Recommendations

#### Carbide Grade Options

- |          |  |
|----------|--|
| C5 (P35) | General purpose carbide grade suitable for most applications.<br>▶ <i>Common application in steels and stainless steels.</i>               |
| C1 (K35) | Toughest carbide grade. Provides the best combination of edge strength and tool life.<br>▶ <i>Recommended for less rigid applications.</i> |
| C2 (K25) | Higher wear resistant carbide suitable for abrasive material applications.<br>▶ <i>Recommended for grey, ductile, and nodular irons.</i>   |

#### Additional Geometry Option

- |                |  |
|----------------|--|
| High Rake (HR) | Provides superior chip control and tool life in long chipping carbon and alloy steels below 200 Bhn. |
|----------------|--|

### IC Inserts

- The design allows for excellent chip control and aggressive penetration rates
- The proprietary AM200° and AM300° coatings increase tool life above competitors' premium coatings
- The same inserts are used for both Revolution Drill and Opening Drill products

## Set-up Instructions



**Step 1:**  
Loosen the mounting screws on both cartridges.



**Step 2:**  
Set one cartridge to the finish diameter by tightening the adjustment screw against the adjustment pin.



**Step 3:**  
Tighten the mounting screws on the cartridge to 11-14 ft-lbf (15-19 N-m).

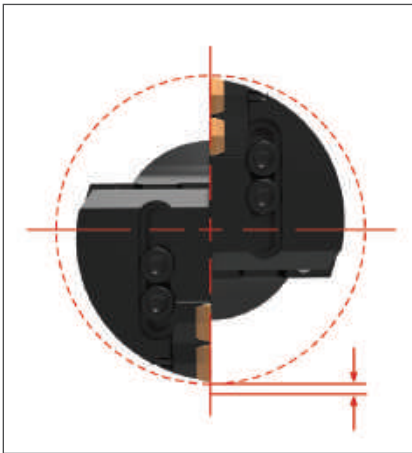

**Step 4:**  
Set the opposing cartridge with 0.160" to 0.200" radial offset inward by tightening the adjustment screw against the adjustment pin (optimum situation for each insert to remove equal material).



**Step 5:**  
Tighten the mounting screws on the cartridge to 11-14 ft-lbf (15-19 N-m).

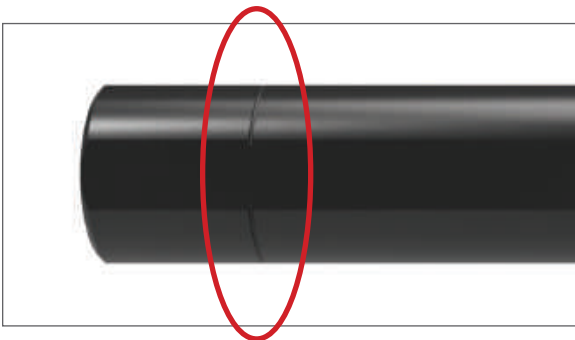

### Straight Shanks

- Designed for lathe applications
- Can be cut off for use in end-mill holders
- The score mark (circled to the left) is provided for recommended cut length
- Cut and deburr at the score mark
- This improves rigidity when the body sits against the face of an end-mill holder



A  
DRILLING  
B  
BORING  
C  
REAMING  
D  
BURNISHING  
E  
THREADING  
X  
SPECIALS

## Product Nomenclature

### Opening Drill Holders

<b>OP1</b>	-	<b>1S</b>	-	<b>SS1.5</b>
1		2		3

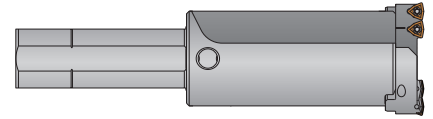

1. Series	2. Length	3. Shank Type	
<b>OP1</b> = 2.00" - 2.50" (50.8mm - 63.5mm) <b>OP2</b> = 2.50" - 3.00" (63.5mm - 76.2mm) <b>OP3</b> = 3.00" - 4.12" (76.2mm - 104.7mm) <b>OP4</b> = 4.12" - 5.62" (104.7mm - 142.8mm)	<b>1S</b> = Short <b>1L</b> = Long	<b>SS1.5</b> = 1-1/2 $\phi$ straight <b>SS2.5</b> = 2-1/2 $\phi$ straight <b>40M</b> = 40mm straight <b>50M</b> = 50mm straight <b>CV40</b> = CAT40 <b>CV50</b> = CAT50	<b>BT40</b> = BT40 <b>BT50</b> = BT50 <b>HSK63</b> = HSK 63A/C <b>HSK100</b> = HSK 100A/C <b>ABS63</b> = ABS63 <b>DV50</b> = DIN50

### Reference Key

Symbol	Attribute
$D_1$	Drill diameter range
$D_2$	Shank diameter
$D_3$	Body diameter
$L_1$	Overall length
$L_2$	Maximum drill depth
$L_4$	Holder length
$L_7$	Shank length
$P_1$	Rear pipe tap

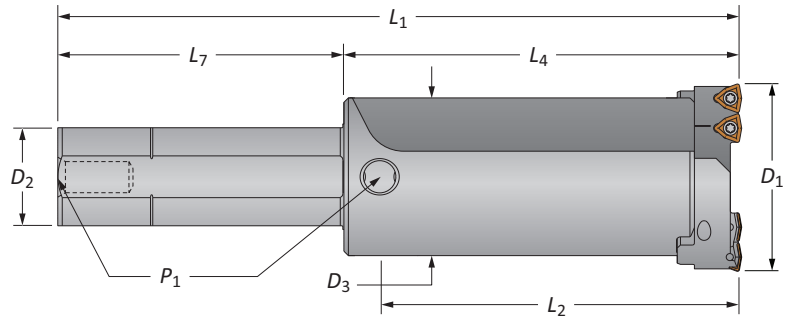

## Product Nomenclature

### Opening Drill Inserts

<b>OP</b>	-	<b>05</b>	<b>T3</b>	<b>08</b>	-	<b>1</b>	<b>H</b>	<b>HR</b>
1		2	3	4		5	6	7

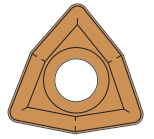

<b>1. Compatible with:</b> Opening Drill Revolution Drill	<b>2. IC Type</b> <b>05 = 5/16"</b>	<b>3. Thickness</b> <b>T3 = 5/32"</b>	<b>4. Radius</b> <b>08 = 1/32"</b>	<b>5. Carbide Grade</b> <b>Blank = C5 (P35)</b> <b>1 = C1 (K35)</b> <b>2 = C2 (K25)</b>
<b>6. Coating</b> <b>P = AM300®</b> <b>H = AM200®</b> <b>T = TiN</b> <b>A = TiAlN</b> <b>N = TiCN</b> <b>U = Uncoated</b>	<b>7. Geometry</b> <b>Blank = General Purpose</b> <b>HR = High Rake</b>			

A

DRILLING

B

BORING

C

REAMING

D

BURNISHING

E

THREADING

X

SPECIALS

## Opening Drill Holders

Straight Shank | Imperial | Diameter Range: 2.00" - 5.62" (50.8mm - 142.8mm)

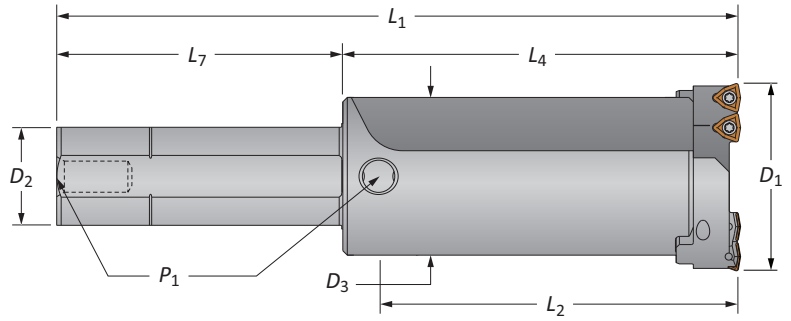

### Holder

Length	D <sub>1</sub> Range	Holder				Shank			Part No.	Cartridges
		D <sub>3</sub>	L <sub>2</sub>	L <sub>4</sub>	L <sub>1</sub>	D <sub>2</sub>	L <sub>7</sub>	P <sub>1</sub>		
Short	2.00 - 2.50	1.840	3-9/32	4-3/64	8-3/64	1-1/2	4	1/4 NPT	<b>OP1-1S-SS1.5</b>	OP1-WC05
Long	2.00 - 2.50	1.840	5-17/32	6-19/64	10-19/64	1-1/2	4	1/4 NPT	<b>OP1-1L-SS1.5</b>	OP1-WC05
Short	2.50 - 3.00	2.220	4-43/64	5-1/2	9-1/2	1-1/2	4	1/4 NPT	<b>OP2-1S-SS1.5</b>	OP2-WC05
Long	2.50 - 3.00	2.220	7-43/64	8-1/2	12-1/2	1-1/2	4	1/4 NPT	<b>OP2-1L-SS1.5</b>	OP2-WC05
Short	3.00 - 4.12	2.806	5-7/64	6	10	1-1/2	4	1/4 NPT	<b>OP3-1S-SS1.5</b>	OP3-WC05
Long	3.00 - 4.12	2.806	9-7/64	10	14	1-1/2	4	1/4 NPT	<b>OP3-1L-SS1.5</b>	OP3-WC05
Short	4.12 - 5.62	3.500	5-1/64	6	10-1/2	2	4-1/2	1/4 NPT	<b>OP4-1S-SS2.0</b>	OP4-WC05
Long	4.12 - 5.62	3.500	10-33/64	11-1/2	16	2	4-1/2	1/4 NPT	<b>OP4-1L-SS2.0</b>	OP4-WC05

\*Holder includes cartridges; however, inserts are sold separately.

### Cartridges

Replacement Cartridges	Qty. Inserts Needed	Mounting Screw	Key Size	Adjusting Screw	Driver
OP1-WC05	2	MS-13M-1	5mm	AS-10T9-1	8T-9
OP2-WC05	2	MS-15M-1	5mm	AS-10T9-1	8T-9
OP3-WC05	2	MS-15M-1	5mm	AS-12T9-1	8T-9
OP4-WC05	3	MS-15M-1	5mm	AS-14T9-1	8T-9

### IC Inserts

Carbide Grade	Geometry	Part No.			Insert Screws	Driver
		AM300®	AM200®	TiN		
C5 (P35)	Standard	OP-05T308-P	OP-05T308-H	OP-05T308-T	IS-10-1	8T-9
C1 (K35)	Standard	OP-05T308-1P	OP-05T308-1H	OP-05T308-1T	IS-10-1	8T-9
C2 (K25)	Standard	OP-05T308-2P	OP-05T308-2H	-	IS-10-1	8T-9
C5 (P35)	High Rake	OP-05T308-PHR	OP-05T308-HHR	-	IS-10-1	8T-9

A70: 14 - 17  
A70: 2 - 3

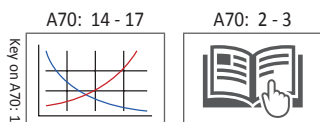

Mounting screws sold in multiples of 4 | Adjusting screws sold in multiples of 4  
IC inserts sold in multiples of 10 | Insert screws sold in multiples of 10

**i** = Imperial (in)  
**m** = Metric (mm)

## Opening Drill Holders

Straight Shank | Metric | Diameter Range: 2.00" - 5.62" (50.8mm - 142.8mm)

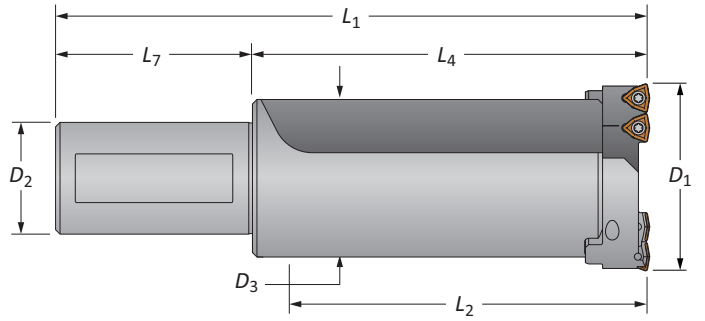

### Holder

Length	D <sub>1</sub> Range	Holder				Shank			Part No.	Cartridges	
		D <sub>3</sub>	L <sub>2</sub>	L <sub>4</sub>	L <sub>1</sub>	D <sub>2</sub>	L <sub>7</sub>	P <sub>1</sub>			
m	Short	50.8 - 63.5	1.840	83.5	102.9	172.9	40	70	-	OP1-1S-40M	OP1-WC05
	Long	50.8 - 63.5	1.840	140.6	160.1	230.1	40	70	-	OP1-1L-40M	OP1-WC05
	Short	63.5 - 76.2	2.220	118.5	139.8	209.8	40	70	-	OP2-1S-40M	OP2-WC05
	Long	63.5 - 76.2	2.220	194.7	216.0	286.0	40	70	-	OP2-1L-40M	OP2-WC05
	Short	76.2 - 104.7	2.806	129.9	152.5	222.5	40	70	-	OP3-1S-40M	OP3-WC05
	Long	76.2 - 104.7	2.806	231.5	254.1	324.1	40	70	-	OP3-1L-40M	OP3-WC05
	Short	104.7 - 142.8	3.500	127.4	152.5	232.5	50	80	-	OP4-1S-50M	OP4-WC05
	Long	104.7 - 142.8	3.500	254.4	292.2	372.2	50	80	-	OP4-1L-50M	OP4-WC05

\*Holder includes cartridges; however, inserts are sold separately.

### Cartridges

Replacement Cartridges	Qty. Inserts Needed	Mounting Screw	Key Size	Adjusting Screw	Driver
OP1-WC05	2	MS-13M-1	5mm	AS-10T9-1	8T-9
OP2-WC05	2	MS-15M-1	5mm	AS-10T9-1	8T-9
OP3-WC05	2	MS-15M-1	5mm	AS-12T9-1	8T-9
OP4-WC05	3	MS-15M-1	5mm	AS-14T9-1	8T-9

### IC Inserts

Carbide Grade	Geometry	Part No.			Insert Screws	Driver
		AM300®	AM200®	TiN		
C5 (P35)	Standard	OP-05T308-P	OP-05T308-H	OP-05T308-T	IS-10-1	8T-9
C1 (K35)	Standard	OP-05T308-1P	OP-05T308-1H	OP-05T308-1T	IS-10-1	8T-9
C2 (K25)	Standard	OP-05T308-2P	OP-05T308-2H	-	IS-10-1	8T-9
C5 (P35)	High Rake	OP-05T308-PHR	OP-05T308-HHR	-	IS-10-1	8T-9

## Opening Drill Holders

CAT40 Shank | Diameter Range: 2.00" - 5.62" (50.8mm - 142.8mm)

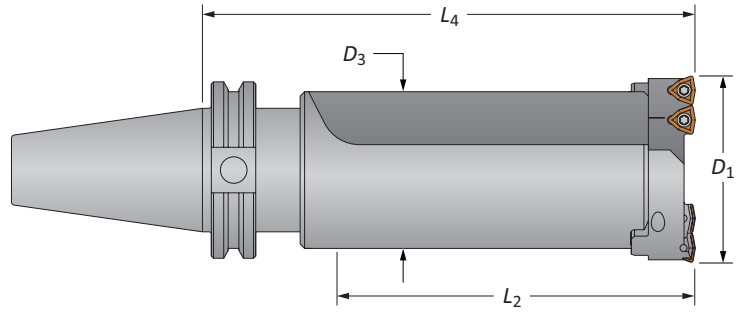

### Holder

Length	D <sub>1</sub> Range	D <sub>3</sub>	Holder		Part No.	Cartridges
			L <sub>2</sub>	L <sub>4</sub>		
Short	2.00 - 2.50	1.840	3-9/32	5-27/64	OP1-1S-CV40	OP1-WC05
Long	2.00 - 2.50	1.840	5-17/32	7-43/64	OP1-1L-CV40	OP1-WC05
Short	2.50 - 3.00	2.220	4-43/64	6-7/8	OP2-1S-CV40	OP2-WC05
Long	2.50 - 3.00	2.220	7-43/64	9-7/8	OP2-1L-CV40	OP2-WC05
Short	3.00 - 4.12	2.806	5-7/64	7-3/8	OP3-1S-CV40	OP3-WC05
Long	3.00 - 4.12	2.806	9-7/64	11-3/8	OP3-1L-CV40	OP3-WC05
Short	4.12 - 5.62	3.500	5-1/64	7-3/8	OP4-1S-CV40	OP4-WC05

\*Holder includes cartridges; however, inserts are sold separately.

### Cartridges

Replacement Cartridges	Qty. Inserts Needed	Mounting Screw	Key Size	Adjusting Screw	Driver
OP1-WC05	2	MS-13M-1	5mm	AS-10T9-1	8T-9
OP2-WC05	2	MS-15M-1	5mm	AS-10T9-1	8T-9
OP3-WC05	2	MS-15M-1	5mm	AS-12T9-1	8T-9
OP4-WC05	3	MS-15M-1	5mm	AS-14T9-1	8T-9

### IC Inserts

Carbide Grade	Geometry	Part No.			Insert Screws	Driver
		AM300®	AM200®	TiN		
C5 (P35)	Standard	OP-05T308-P	OP-05T308-H	OP-05T308-T	IS-10-1	8T-9
C1 (K35)	Standard	OP-05T308-1P	OP-05T308-1H	OP-05T308-1T	IS-10-1	8T-9
C2 (K25)	Standard	OP-05T308-2P	OP-05T308-2H	-	IS-10-1	8T-9
C5 (P35)	High Rake	OP-05T308-PHR	OP-05T308-HHR	-	IS-10-1	8T-9

A70: 14 - 17

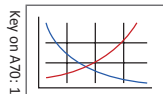

A70: 2 - 3



Mounting screws sold in multiples of 4 | Adjusting screws sold in multiples of 4  
 IC inserts sold in multiples of 10 | Insert screws sold in multiples of 10

**i** = Imperial (in)  
**m** = Metric (mm)

A DRILLING  
 B BORING  
 C REAMING  
 D BURNISHING  
 E THREADING  
 X SPECIALS



## Opening Drill Holders

CAT50 Shank | Diameter Range: 2.00" - 5.62" (50.8mm - 142.8mm)

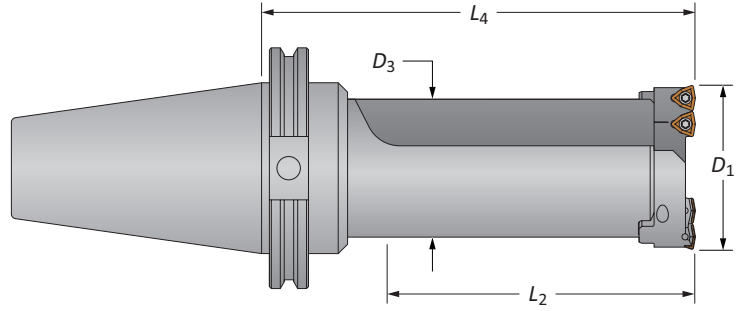

### Holders

Length	D <sub>1</sub> Range	Holder			Part No.	Cartridges
		D <sub>3</sub>	L <sub>2</sub>	L <sub>4</sub>		
Short	2.00 - 2.50	1.840	3-9/32	5-27/64	<b>OP1-1S-CV50</b>	OP1-WC05
			5-17/32	7-43/64	<b>OP1-1L-CV50</b>	OP1-WC05
Long	2.50 - 3.00	2.220	4-43/64	6-7/8	<b>OP2-1S-CV50</b>	OP2-WC05
			7-43/64	9-7/8	<b>OP2-1L-CV50</b>	OP2-WC05
Short	3.00 - 4.12	2.806	5-7/64	7-3/8	<b>OP3-1S-CV50</b>	OP3-WC05
			9-7/64	11-3/8	<b>OP3-1L-CV50</b>	OP3-WC05
Long	4.12 - 5.62	3.500	5-1/64	7-3/8	<b>OP4-1S-CV50</b>	OP4-WC05
			10-33/64	12-7/8	<b>OP4-1L-CV50</b>	OP4-WC05

\*Holder includes cartridges; however, inserts are sold separately.

### Cartridges

Replacement Cartridges	Qty. Inserts Needed	Mounting Screw	Key Size	Adjusting Screw	Driver
<b>OP1-WC05</b>	2	MS-13M-1	5mm	AS-10T9-1	8T-9
<b>OP2-WC05</b>	2	MS-15M-1	5mm	AS-10T9-1	8T-9
<b>OP3-WC05</b>	2	MS-15M-1	5mm	AS-12T9-1	8T-9
<b>OP4-WC05</b>	3	MS-15M-1	5mm	AS-14T9-1	8T-9

### IC Inserts

Carbide Grade	Geometry	Part No.			Insert Screws	Driver
		AM300®	AM200®	TiN		
C5 (P35)	Standard	<b>OP-05T308-P</b>	<b>OP-05T308-H</b>	<b>OP-05T308-T</b>	IS-10-1	8T-9
C1 (K35)	Standard	<b>OP-05T308-1P</b>	<b>OP-05T308-1H</b>	<b>OP-05T308-1T</b>	IS-10-1	8T-9
C2 (K25)	Standard	<b>OP-05T308-2P</b>	<b>OP-05T308-2H</b>	–	IS-10-1	8T-9
C5 (P35)	High Rake	<b>OP-05T308-PHR</b>	<b>OP-05T308-HHR</b>	–	IS-10-1	8T-9

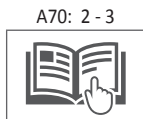
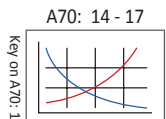

Mounting screws sold in multiples of 4 | Adjusting screws sold in multiples of 4  
 IC inserts sold in multiples of 10 | Insert screws sold in multiples of 10

**i** = Imperial (in)  
**m** = Metric (mm)

## Opening Drill Holders

BT40 Shank | Diameter Range: 2.00" - 5.62" (50.8mm - 142.8mm)

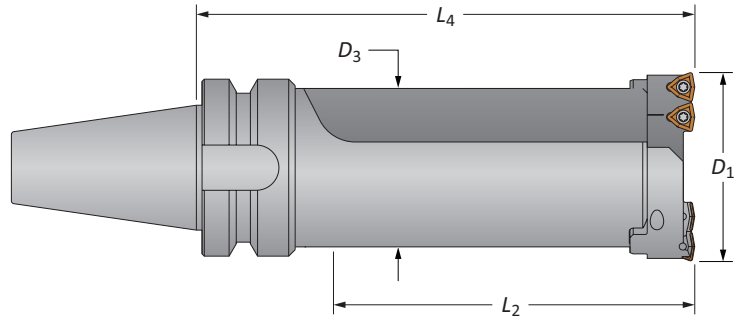

### Holder

	Length	D <sub>1</sub> Range	Holder			Part No.	Cartridges
			D <sub>3</sub>	L <sub>2</sub>	L <sub>4</sub>		
m	Short	50.8 - 63.5	1.840	83.5	137.8	OP1-1S-BT40	OP1-WC05
	Long	50.8 - 63.5	1.840	140.6	195.0	OP1-1L-BT40	OP1-WC05
	Short	63.5 - 76.2	2.220	118.5	174.7	OP2-1S-BT40	OP2-WC05
	Long	63.5 - 76.2	2.220	194.7	250.9	OP2-1L-BT40	OP2-WC05
	Short	76.2 - 104.7	2.806	129.9	187.4	OP3-1S-BT40	OP3-WC05
	Long	76.2 - 104.7	2.806	231.5	289.0	OP3-1L-BT40	OP3-WC05
	Short	104.7 - 142.8	3.500	127.4	187.4	OP4-1S-BT40	OP4-WC05

\*Holder includes cartridges; however, inserts are sold separately.

### Cartridges

Replacement Cartridges	Qty. Inserts Needed	Mounting Screw	Key Size	Adjusting Screw	Driver
OP1-WC05	2	MS-13M-1	5mm	AS-10T9-1	8T-9
OP2-WC05	2	MS-15M-1	5mm	AS-10T9-1	8T-9
OP3-WC05	2	MS-15M-1	5mm	AS-12T9-1	8T-9
OP4-WC05	3	MS-15M-1	5mm	AS-14T9-1	8T-9

### IC Inserts

Carbide Grade	Geometry	Part No.			Insert Screws	Driver
		AM300®	AM200®	TiN		
C5 (P35)	Standard	OP-05T308-P	OP-05T308-H	OP-05T308-T	IS-10-1	8T-9
C1 (K35)	Standard	OP-05T308-1P	OP-05T308-1H	OP-05T308-1T	IS-10-1	8T-9
C2 (K25)	Standard	OP-05T308-2P	OP-05T308-2H	-	IS-10-1	8T-9
C5 (P35)	High Rake	OP-05T308-PHR	OP-05T308-HHR	-	IS-10-1	8T-9

A70: 14 - 17

A70: 2 - 3

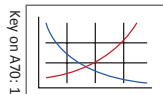

Mounting screws sold in multiples of 4 | Adjusting screws sold in multiples of 4  
 IC inserts sold in multiples of 10 | Insert screws sold in multiples of 10

i = Imperial (in)  
 m = Metric (mm)

A DRILLING  
 B BORING  
 C REAMING  
 D BURNISHING  
 E THREADING  
 X SPECIALS

## Opening Drill Holders

BT50 Shank | Diameter Range: 2.00" - 5.62" (50.8mm - 142.8mm)

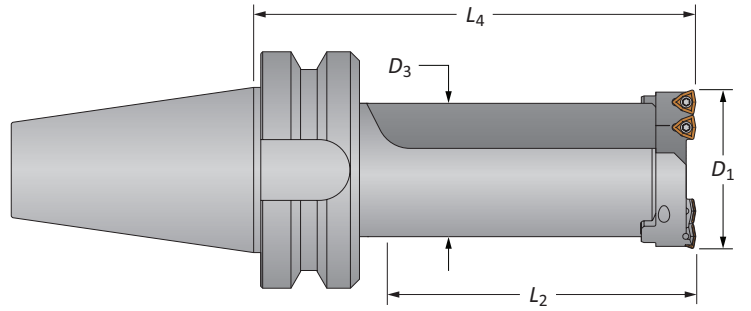

### Holder

	Length	D <sub>1</sub> Range	Holder			Part No.	Cartridges
			D <sub>3</sub>	L <sub>2</sub>	L <sub>4</sub>		
m	Short	50.8 - 63.5	1.840	83.5	147.4	OP1-1S-BT50	OP1-WC05
	Long	50.8 - 63.5	1.840	140.6	204.5	OP1-1L-BT50	OP1-WC05
	Short	63.5 - 76.2	2.220	118.5	174.7	OP2-1S-BT50	OP2-WC05
	Long	63.5 - 76.2	2.220	194.7	260.4	OP2-1L-BT50	OP2-WC05
	Short	76.2 - 104.7	2.806	129.9	196.9	OP3-1S-BT50	OP3-WC05
	Long	76.2 - 104.7	2.806	231.5	298.5	OP3-1L-BT50	OP3-WC05
	Short	104.7 - 142.8	3.500	127.4	196.9	OP4-1S-BT50	OP4-WC05
	Long	104.7 - 142.8	3.500	254.4	336.5	OP4-1L-BT50	OP4-WC05

\*Holder includes cartridges; however, inserts are sold separately.

### Cartridges

Replacement Cartridges	Qty. Inserts Needed	Mounting Screw	Key Size	Adjusting Screw	Driver
OP1-WC05	2	MS-13M-1	5mm	AS-10T9-1	8T-9
OP2-WC05	2	MS-15M-1	5mm	AS-10T9-1	8T-9
OP3-WC05	2	MS-15M-1	5mm	AS-12T9-1	8T-9
OP4-WC05	3	MS-15M-1	5mm	AS-14T9-1	8T-9

### IC Inserts

Carbide Grade	Geometry	Part No.			Insert Screws	Driver
		AM300®	AM200®	TiN		
C5 (P35)	Standard	OP-05T308-P	OP-05T308-H	OP-05T308-T	IS-10-1	8T-9
C1 (K35)	Standard	OP-05T308-1P	OP-05T308-1H	OP-05T308-1T	IS-10-1	8T-9
C2 (K25)	Standard	OP-05T308-2P	OP-05T308-2H	-	IS-10-1	8T-9
C5 (P35)	High Rake	OP-05T308-PHR	OP-05T308-HHR	-	IS-10-1	8T-9

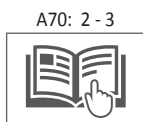
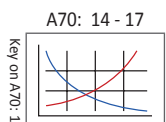

Mounting screws sold in multiples of 4 | Adjusting screws sold in multiples of 4  
 IC inserts sold in multiples of 10 | Insert screws sold in multiples of 10

 = Imperial (in)  
 = Metric (mm)

## Opening Drill Holders

HSK63 Shank | Diameter Range: 2.00" - 5.62" (50.8mm - 142.8mm)

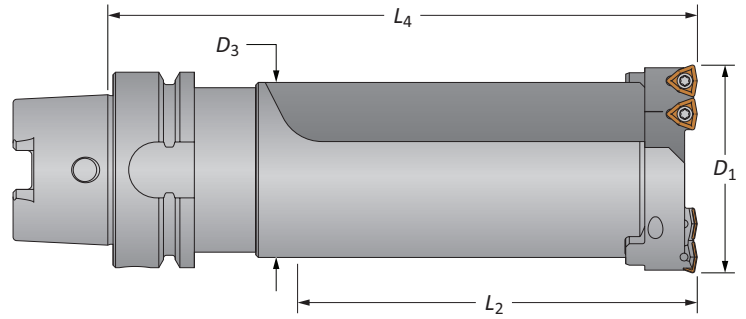

### Holder

Length	D <sub>1</sub> Range	D <sub>3</sub>	Holder		Part No.	Cartridges
			L <sub>2</sub>	L <sub>4</sub>		
Short	2.00 - 2.50	1.840	3-9/32	5-59/64	<b>OP1-1S-HSK63</b>	OP1-WC05
Long	2.00 - 2.50	1.840	5-17/32	8-11/64	<b>OP1-1L-HSK63</b>	OP1-WC05
Short	2.50 - 3.00	2.220	4-43/64	7-3/8	<b>OP2-1S-HSK63</b>	OP2-WC05
Long	2.50 - 3.00	2.220	7-43/64	10-3/8	<b>OP2-1L-HSK63</b>	OP2-WC05
Short	3.00 - 4.12	2.806	5-7/64	7-7/8	<b>OP3-1S-HSK63</b>	OP3-WC05
Long	3.00 - 4.12	2.806	9-7/64	11-7/8	<b>OP3-1L-HSK63</b>	OP3-WC05
Short	4.12 - 5.62	3.500	5-1/64	7-7/8	<b>OP4-1S-HSK63</b>	OP4-WC05

\*Holder includes cartridges; however, inserts are sold separately.

### Cartridges

Replacement Cartridges	Qty. Inserts Needed	Mounting Screw	Key Size	Adjusting Screw	Driver
<b>OP1-WC05</b>	2	MS-13M-1	5mm	AS-10T9-1	8T-9
<b>OP2-WC05</b>	2	MS-15M-1	5mm	AS-10T9-1	8T-9
<b>OP3-WC05</b>	2	MS-15M-1	5mm	AS-12T9-1	8T-9
<b>OP4-WC05</b>	3	MS-15M-1	5mm	AS-14T9-1	8T-9

### IC Inserts

Carbide Grade	Geometry	Part No.			Insert Screws	Driver
		AM300®	AM200®	TiN		
C5 (P35)	Standard	<b>OP-05T308-P</b>	<b>OP-05T308-H</b>	<b>OP-05T308-T</b>	IS-10-1	8T-9
C1 (K35)	Standard	<b>OP-05T308-1P</b>	<b>OP-05T308-1H</b>	<b>OP-05T308-1T</b>	IS-10-1	8T-9
C2 (K25)	Standard	<b>OP-05T308-2P</b>	<b>OP-05T308-2H</b>	–	IS-10-1	8T-9
C5 (P35)	High Rake	<b>OP-05T308-PHR</b>	<b>OP-05T308-HHR</b>	–	IS-10-1	8T-9

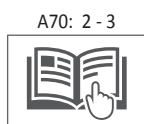
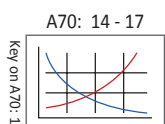

Mounting screws sold in multiples of 4 | Adjusting screws sold in multiples of 4  
 IC inserts sold in multiples of 10 | Insert screws sold in multiples of 10

**i** = Imperial (in)  
**m** = Metric (mm)

A  
DRILLING  
B  
BORING  
C  
REAMING  
D  
BURNISHING  
E  
THREADING  
X  
SPECIALS

## Opening Drill Holders

HSK100 Shank | Diameter Range: 2.00" - 5.62" (50.8mm - 142.8mm)

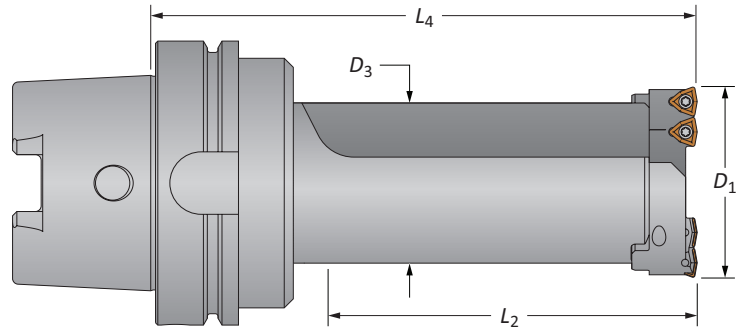

### Holders

Length	D <sub>1</sub> Range	D <sub>3</sub>	Holder		Part No.	Cartridges
			L <sub>2</sub>	L <sub>4</sub>		
Short	2.00 - 2.50	1.840	3-9/32	6-1/64	<b>OP1-1S-HSK100</b>	OP1-WC05
			5-17/32	8-17/64	<b>OP1-1L-HSK100</b>	OP1-WC05
Long	2.50 - 3.00	2.220	4-43/64	7-15/32	<b>OP2-1S-HSK100</b>	OP2-WC05
			7-43/64	10-15/32	<b>OP2-1L-HSK100</b>	OP2-WC05
Short	3.00 - 4.12	2.806	5-7/64	7-31/32	<b>OP3-1S-HSK100</b>	OP3-WC05
			9-7/64	11-31/32	<b>OP3-1L-HSK100</b>	OP3-WC05
Long	4.12 - 5.62	3.500	5-1/64	7-31/32	<b>OP4-1S-HSK100</b>	OP4-WC05
			10-33/64	13-15/32	<b>OP4-1L-HSK100</b>	OP4-WC05

\*Holder includes cartridges; however, inserts are sold separately.

### Cartridges

Replacement Cartridges	Qty. Inserts Needed	Mounting Screw	Key Size	Adjusting Screw	Driver
OP1-WC05	2	MS-13M-1	5mm	AS-10T9-1	8T-9
OP2-WC05	2	MS-15M-1	5mm	AS-10T9-1	8T-9
OP3-WC05	2	MS-15M-1	5mm	AS-12T9-1	8T-9
OP4-WC05	3	MS-15M-1	5mm	AS-14T9-1	8T-9

### IC Inserts

Carbide Grade	Geometry	Part No.			Insert Screws	Driver
		AM300®	AM200®	TiN		
C5 (P35)	Standard	OP-05T308-P	OP-05T308-H	OP-05T308-T	IS-10-1	8T-9
C1 (K35)	Standard	OP-05T308-1P	OP-05T308-1H	OP-05T308-1T	IS-10-1	8T-9
C2 (K25)	Standard	OP-05T308-2P	OP-05T308-2H	-	IS-10-1	8T-9
C5 (P35)	High Rake	OP-05T308-PHR	OP-05T308-HHR	-	IS-10-1	8T-9

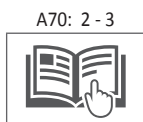
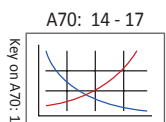

Mounting screws sold in multiples of 4 | Adjusting screws sold in multiples of 4  
 IC inserts sold in multiples of 10 | Insert screws sold in multiples of 10

**I** = Imperial (in)  
**M** = Metric (mm)

## Opening Drill Holders

ABS63 Shank | Diameter Range: 2.00" - 5.62" (50.8mm - 142.8mm)

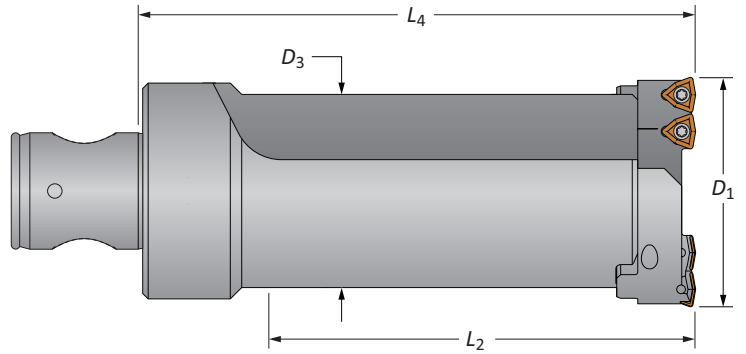

### Holder

Length	D <sub>1</sub> Range	D <sub>3</sub>	Holder		Part No.	Cartridges
			L <sub>2</sub>	L <sub>4</sub>		
Short	2.00 - 2.50	1.840	3-9/32	5-1/2	OP1-1S-ABS63	OP1-WC05
Long	2.00 - 2.50	1.840	5-17/32	7-3/4	OP1-1L-ABS63	OP1-WC05
Short	2.50 - 3.00	2.220	4-43/64	6-1/4	OP2-1S-ABS63	OP2-WC05
Long	2.50 - 3.00	2.220	7-43/64	9-1/4	OP2-1L-ABS63	OP2-WC05
Short	3.00 - 4.12	2.806	5-7/64	6-3/4	OP3-1S-ABS63	OP3-WC05
Long	3.00 - 4.12	2.806	9-7/64	10-3/4	OP3-1L-ABS63	OP3-WC05
Short	4.12 - 5.62	3.500	5-1/64	6-3/4	OP4-1S-ABS63	OP4-WC05

\*Holder includes cartridges; however, inserts are sold separately.

### Cartridges

Replacement Cartridges	Qty. Inserts Needed	Mounting Screw	Key Size	Adjusting Screw	Driver
OP1-WC05	2	MS-13M-1	5mm	AS-10T9-1	8T-9
OP2-WC05	2	MS-15M-1	5mm	AS-10T9-1	8T-9
OP3-WC05	2	MS-15M-1	5mm	AS-12T9-1	8T-9
OP4-WC05	3	MS-15M-1	5mm	AS-14T9-1	8T-9

### IC Inserts

Carbide Grade	Geometry	Part No.			Insert Screws	Driver
		AM300®	AM200®	TiN		
C5 (P35)	Standard	OP-05T308-P	OP-05T308-H	OP-05T308-T	IS-10-1	8T-9
C1 (K35)	Standard	OP-05T308-1P	OP-05T308-1H	OP-05T308-1T	IS-10-1	8T-9
C2 (K25)	Standard	OP-05T308-2P	OP-05T308-2H	-	IS-10-1	8T-9
C5 (P35)	High Rake	OP-05T308-PHR	OP-05T308-HHR	-	IS-10-1	8T-9

A70: 14 - 17

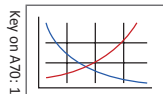

A70: 2 - 3



Mounting screws sold in multiples of 4 | Adjusting screws sold in multiples of 4  
 IC inserts sold in multiples of 10 | Insert screws sold in multiples of 10

**i** = Imperial (in)  
**m** = Metric (mm)

A DRILLING  
 B BORING  
 C REAMING  
 D BURNISHING  
 E THREADING  
 X SPECIALS

## Opening Drill Holders

DIN50 Shank | Diameter Range: 2.00" - 5.62" (50.8mm - 142.8mm)

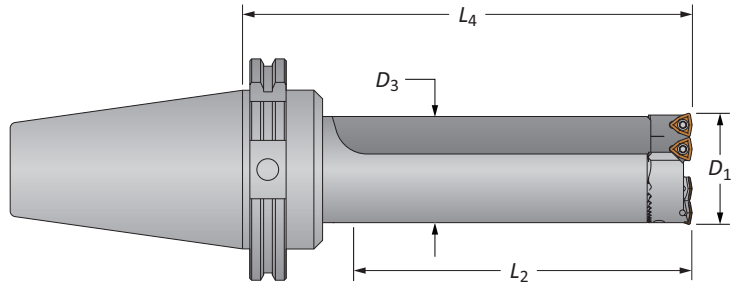

### Holder

Length	D <sub>1</sub> Range	D <sub>3</sub>	Holder		Part No.	Cartridges
			L <sub>2</sub>	L <sub>4</sub>		
Short	50.8 - 63.5	1.840	83.5	137.9	OP1-1S-DV50	OP1-WC05
			140.6	195.1	OP1-1L-DV50	OP1-WC05
Long	50.8 - 63.5	1.840	118.5	174.8	OP2-1S-DV50	OP2-WC05
			194.7	251.0	OP2-1L-DV50	OP2-WC05
Short	63.5 - 76.2	2.220	129.9	187.5	OP3-1S-DV50	OP3-WC05
			231.5	289.1	OP3-1L-DV50	OP3-WC05
Long	63.5 - 76.2	2.220	127.4	187.5	OP4-1S-DV50	OP4-WC05
			254.4	327.2	OP4-1L-DV50	OP4-WC05

\*Holder includes cartridges; however, inserts are sold separately.

### Cartridges

Replacement Cartridges	Qty. Inserts Needed	Mounting Screw	Key Size	Adjusting Screw	Driver
OP1-WC05	2	MS-13M-1	5mm	AS-10T9-1	8T-9
OP2-WC05	2	MS-15M-1	5mm	AS-10T9-1	8T-9
OP3-WC05	2	MS-15M-1	5mm	AS-12T9-1	8T-9
OP4-WC05	3	MS-15M-1	5mm	AS-14T9-1	8T-9

### IC Inserts

Carbide Grade	Geometry	Part No.			Insert Screws	Driver
		AM300®	AM200®	TiN		
C5 (P35)	Standard	OP-05T308-P	OP-05T308-H	OP-05T308-T	IS-10-1	8T-9
C1 (K35)	Standard	OP-05T308-1P	OP-05T308-1H	OP-05T308-1T	IS-10-1	8T-9
C2 (K25)	Standard	OP-05T308-2P	OP-05T308-2H	-	IS-10-1	8T-9
C5 (P35)	High Rake	OP-05T308-PHR	OP-05T308-HHR	-	IS-10-1	8T-9

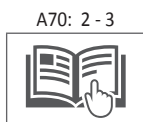
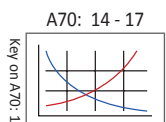

Mounting screws sold in multiples of 4 | Adjusting screws sold in multiples of 4  
 IC inserts sold in multiples of 10 | Insert screws sold in multiples of 10

 = Imperial (in)  
 = Metric (mm)

**Recommended Cutting Data | Imperial (inch)**

ISO	Material	Hardness (BHN)	Speed (SFM)			Feed Rate (IPR)
			AM300®	AM200®	TiN	
P	<b>Free Machining Steel</b> 1118, 1215, 12L14, etc.	100 - 250	900 - 1300	850 - 1200	700 - 900	.0035 - .007
	<b>Low Carbon Steel</b> 1010, 1020, 1025, 1522, 1144, etc.	85 - 275	850 - 1250	800 - 1150	650 - 850	.003 - .0065
	<b>Medium Carbon Steel</b> 1030, 1040, 1050, 1527, 1140, 1151, etc.	125 - 325	800 - 1050	750 - 950	600 - 850	.0035 - .0065
	<b>Alloy Steel</b> 4140, 5140, 8640, etc.	125 - 375	750 - 1000	700 - 900	600 - 850	.0035 - .0065
	<b>High Strength Alloy</b> 4340, 4330V, 300M, etc.	225 - 400	600 - 850	550 - 750	400 - 650	.003 - .005
	<b>Structural Steel</b> A36, A285, A516, etc.	100 - 350	850 - 1050	800 - 950	650 - 850	.003 - .0065
	<b>Tool Steel</b> H-13, H-21, A-4, O-2, S-3, etc.	150 - 250	400 - 800	350 - 700	250 - 650	.0025 - .005
	<b>S</b>	<b>High Temp Alloy</b> Hastelloy B, Inconel 600, etc.	140 - 310	250 - 450	250 - 350	150 - 300
M	<b>Stainless Steel 400 Series</b> 416, 420, etc.	185 - 350	600 - 850	550 - 750	400 - 650	.003 - .006
	<b>Stainless Steel 300 Series</b> 304, 316, 17-4PH, etc.	135 - 275	600 - 850	550 - 750	400 - 650	.003 - .006
	<b>Super Duplex Stainless Steel</b>	135 - 275	500 - 750	450 - 650	300 - 550	.002 - .005
K	<b>Nodular, Grey, Ductile Cast Iron</b>	120 - 320	700 - 900	650 - 800	500 - 700	.004 - .008
N	<b>Cast Aluminum</b>	30 - 180	1250 - 1650	1200 - 1550	950 - 1100	.006 - .012
	<b>Wrought Aluminum</b>	30 - 180	1250 - 1650	1200 - 1550	950 - 1100	.006 - .012
	<b>Brass</b>	30 - 100	950 - 1350	900 - 1250	750 - 1100	.005 - .009

**Minimum Pilot Hole Diameter = Finish Diameter - C**

Ex: To open an existing diameter hole to 2.75" diameter, an OP2 tool would be used. The minimum pilot hole diameter would be: **2.750 - 1.880 = 0.870"**

Opening Drill Series	Drill Diameter Range	C
OP1	2.00 - 2.50	1.880
OP2	2.50 - 3.00	1.880
OP3	3.00 - 4.12	1.880
OP4	4.12 - 5.62	2.680

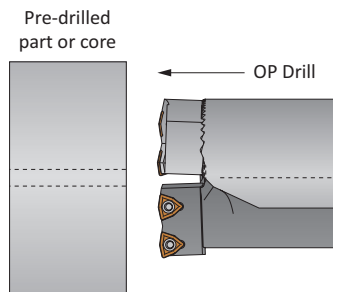

**IMPORTANT:** The speeds and feeds listed above are considered a general starting point for all applications. Factory technical assistance is available for your specific applications through our Application Engineering department.



## Formulas and Constants | Imperial (inch)

### Material Constants

Type of Material	Hardness (BHN)	K <sub>m</sub> (lbs/in <sup>2</sup> )
Free Machining Steel	100 - 250	0.75
Low Carbon Steel	85 - 275	0.85
Medium Carbon Steel	125 - 325	0.90
Alloy Steel	125 - 375	1.00
High Strength Steel	225 - 400	1.15
Structural Steel	100 - 350	1.00
Tool Steel	150 - 250	0.90
High Temperature Alloy	140 - 310	1.44
Titanium Alloy	140 - 310	0.72
Aerospace Alloy	185 - 350	0.70
Stainless Steel 400 Series	185 - 350	1.08
Stainless Steel 300 Series	135 - 275	0.94
Super Duplex Stainless Steel	135 - 275	0.94
Wear Plate	400 - 600	1.60
Hardened Steel	300 - 500	1.40
Nodular, Ductile Cast Iron	120 - 320	0.65
Grey Cast Iron	120 - 320	0.75
Cast Aluminum	30 - 180	0.40
Wrought Aluminum	30 - 180	0.40
Aluminum Bronze	100 - 250	0.50
Brass	100	0.35
Copper	60	0.30

### Formulas

1. <b>RPM</b>	<b>= (3.82 • SFM) / DIA<sub>F</sub></b>
<i>where:</i>	
RPM	= revolutions per minute (rev/min)
SFM	= speed (ft/min)
DIA <sub>F</sub>	= finish diameter of drill (inch)
2. <b>HP</b>	<b>= (0.5891 • (DIA<sub>F</sub><sup>2</sup> – DIA<sub>P</sub><sup>2</sup>) • IPR • RPM • K<sub>m</sub>) / 0.80</b>
<i>where:</i>	
Tool Power	= tool power (HP)
DIA <sub>F</sub>	= finish diameter of drill (inch)
DIA <sub>P</sub>	= pre-drill diameter (inch)
IPR	= feed rate (in/rev)
RPM	= revolutions per minute (rev/min)
K <sub>m</sub>	= specific cutting energy (lbs/in <sup>2</sup> ) machine efficiency (using 0.80 as constant)
3. <b>Thrust</b>	<b>= 148,500 • IPR • (DIA<sub>F</sub> – DIA<sub>P</sub>) • K<sub>m</sub></b>
<i>where:</i>	
Thrust	= axial thrust (lbs)
IPR	= feed rate (in/rev)
DIA <sub>F</sub>	= finish diameter of drill (inch)
DIA <sub>P</sub>	= pre-drill diameter (inch)
K <sub>m</sub>	= specific cutting energy (lbs/in <sup>2</sup> )
5. <b>Torque</b>	<b>= (HP • 5252) / RPM</b>
<i>where:</i>	
Torque	= torque (ft/lbs)
HP	= tool power (HP)
RPM	= revolutions per minute (rev/min)

The table and equations on this page are found in the *Machinery's Handbook*. Permission to simplify and print the equations is granted by the Editor of the *Machinery's Handbook*.

A

DRILLING

B

BORING

C

REAMING

D

BURNISHING



E

THREADING

X

SPECIALS

**Recommended Cutting Data | Metric (mm)**

ISO	Material	Hardness (BHN)	Speed (M/min)			Feed Rate (mm/rev)
			 AM300®	 AM200®	 TiN	
P	<b>Free Machining Steel</b> 1118, 1215, 12L14, etc.	100 - 250	274 - 396	259 - 366	213 - 274	0.09 - 0.18
	<b>Low Carbon Steel</b> 1010, 1020, 1025, 1522, 1144, etc.	85 - 275	259 - 381	244 - 351	198 - 259	0.08 - 0.17
	<b>Medium Carbon Steel</b> 1030, 1040, 1050, 1527, 1140, 1151, etc.	125 - 325	244 - 320	229 - 290	183 - 259	0.09 - 0.17
	<b>Alloy Steel</b> 4140, 5140, 8640, etc.	125 - 375	229 - 305	213 - 274	183 - 259	0.09 - 0.17
	<b>High Strength Alloy</b> 4340, 4330V, 300M, etc.	225 - 400	183 - 259	168 - 229	122 - 198	0.08 - 0.13
	<b>Structural Steel</b> A36, A285, A516, etc.	100 - 350	259 - 320	244 - 290	198 - 259	0.08 - 0.17
	<b>Tool Steel</b> H-13, H-21, A-4, O-2, S-3, etc.	150 - 250	122 - 244	107 - 213	76 - 198	0.06 - 0.13
S	<b>High Temp Alloy</b> Hastelloy B, Inconel 600, etc.	140 - 310	76 - 137	76 - 107	46 - 91	0.06 - 0.11
M	<b>Stainless Steel 400 Series</b> 416, 420, etc.	185 - 350	183 - 259	168 - 229	122 - 198	0.08 - 0.15
	<b>Stainless Steel 300 Series</b> 304, 316, 17-4PH, etc.	135 - 275	183 - 259	168 - 229	122 - 198	0.08 - 0.15
	<b>Super Duplex Stainless Steel</b>	135 - 275	152 - 228	137 - 198	91 - 152	0.05 - 0.12
K	<b>Nodular, Grey, Ductile Cast Iron</b>	120 - 320	213 - 274	198 - 244	152 - 213	0.10 - 0.20
N	<b>Cast Aluminum</b>	30 - 180	381 - 503	381 - 472	290 - 335	0.15 - 0.30
	<b>Wrought Aluminum</b>	30 - 180	381 - 503	381 - 472	290 - 335	0.15 - 0.30
	<b>Brass</b>	30 - 100	290 - 411	274 - 381	229 - 335	0.13 - 0.23

**Minimum Pilot Hole Diameter = Finish Diameter – C**

Ex: To open an existing diameter hole to 69.85mm diameter, an OP2 tool would be used. The minimum pilot hole diameter would be: **69.85 - 47.75 = 22.10**

Opening Drill Series	Drill Diameter Range	C
OP1	50.8 - 63.5	47.75
OP2	63.5 - 76.2	47.75
OP3	76.2 - 104.6	47.75
OP4	104.6 - 142.7	68.07

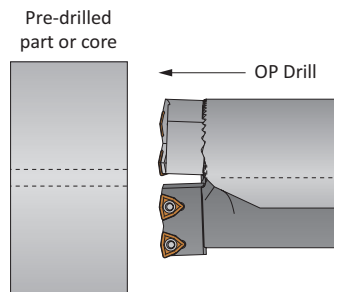

**IMPORTANT:** The speeds and feeds listed above are considered a general starting point for all applications. Factory technical assistance is available for your specific applications through our Application Engineering department.

Formulas and Constants | Metric (mm)

Material Constants

Type of Material	Hardness (BHN)	K <sub>m</sub> (lbs/in <sup>2</sup> )
Free Machining Steel	100 - 250	5.17
Low Carbon Steel	85 - 275	5.86
Medium Carbon Steel	125 - 325	6.21
Alloy Steel	125 - 375	6.90
High Strength Steel	225 - 400	7.93
Structural Steel	100 - 350	6.90
Tool Steel	150 - 250	6.21
High Temperature Alloy	140 - 310	9.93
Titanium Alloy	140 - 310	4.97
Aerospace Alloy	185 - 350	4.48
Stainless Steel 400 Series	185 - 350	7.45
Stainless Steel 300 Series	135 - 275	6.48
Super Duplex Stainless Steel	135 - 275	6.48
Wear Plate	400 - 600	11.04
Hardened Steel	300 - 500	9.66
Nodular, Ductile Cast Iron	120 - 320	4.48
Grey Cast Iron	120 - 320	5.17
Cast Aluminum	30 - 180	2.76
Wrought Aluminum	30 - 180	2.76
Aluminum Bronze	100 - 250	3.45
Brass	100	2.41
Copper	60	2.07

Formulas

1. <b>RPM</b>	<b>= (318.31 • M/min) / DIA<sub>F</sub></b>
<i>where:</i>	
RPM	= revolutions per minute (rev/min)
M/min	= speed (M/min)
DIA <sub>F</sub>	= finish diameter of drill (mm)
2. <b>kW</b>	<b>= ((DIA<sub>F</sub><sup>2</sup> - DIA<sub>P</sub><sup>2</sup>) • mm/rev • RPM • K<sub>m</sub>) / 205,154</b>
<i>where:</i>	
kW	= tool power (kW)
DIA <sub>F</sub>	= finish diameter of drill (mm)
DIA <sub>P</sub>	= pre-drill diameter (mm)
mm/rev	= feed rate (mm/rev)
RPM	= revolutions per minute (rev/min)
K <sub>m</sub>	= specific cutting energy (kPa) machine efficiency (using 205,154 as constant)
3. <b>Thrust</b>	<b>= 148.78 • mm/rev • (DIA<sub>F</sub> - DIA<sub>P</sub>) • K<sub>m</sub></b>
<i>where:</i>	
Thrust	= axial thrust (N)
IPR	= feed rate (mm/rev)
DIA <sub>F</sub>	= finish diameter of drill (mm)
DIA <sub>P</sub>	= pre-drill diameter (mm)
K <sub>m</sub>	= specific cutting energy (kPa)
4. <b>Torque</b>	<b>= (kW • 9549.3) / RPM</b>
<i>where:</i>	
Torque	= torque (Nm)
kW	= tool power (kW)
RPM	= revolutions per minute (rev/min)

The table and equations on this page are found in the *Machinery's Handbook*. Permission to simplify and print the equations is granted by the Editor of the *Machinery's Handbook*.



SECTION

---

# A91

---

Structural Steel Solutions

# Structural Steel Drilling Solutions

Replaceable Insert Drilling System | GEN3SYS® XT Pro | Original T-A® and GEN2 T-A®

- ▶ GEN3SYS XT Pro Diameter Range: 0.4331" - 1.3780" (11.00mm - 35.00mm)
- ▶ T-A Diameter Range: 0.511" - 1.882" (12.98mm - 47.80mm)



## Take on Tough Drilling

Allied Machine's Structural Steel Drilling System is designed for maximum performance in structural steel materials and applications. These solutions utilize the GEN3SYS XT Pro, Original T-A, and GEN2 T-A designs and capabilities.

With multiple geometries and coatings, you're sure to find the solution that is right for you. Tough drilling is tough no more.

Excellent chip control	Improves hole quality and surface finish	Provides maximum durability and stability
------------------------	--	---

Your safety and the safety of others is very important. This catalog contains important safety messages. Always read and follow all safety precautions.



This triangle is a safety hazard symbol. It alerts you to potential safety hazards that can cause tool failure and serious injury.

When you see this symbol in the catalog, look for a related safety message that may be near this triangle or referred to in the nearby text.

There are safety signal words also used in the catalog. Safety messages follow these words.

### **WARNING**

**WARNING** (shown above) means that failure to follow the precautions in this message could result in tool failure and serious injury.

**NOTICE** means that failure to follow the precautions in this message could result in damage to the tool or machine but not result in personal injury.

**NOTE** and **IMPORTANT** are also used. These are important that you read and follow but are not safety-related.

Visit [www.alliedmachine.com](http://www.alliedmachine.com) for the most up-to-date information and procedures.

## Applicable Industries



Structural Steel

# Structural Steel Drilling Solutions Contents

## Introduction Information

Structural Steel Drilling Overview . . . . . 2  
 Case Study Example . . . . . 3

## GEN3SYS® XT Pro System

GEN3SYS XT Pro System Overview . . . . . 4  
 Product Nomenclature . . . . . 5  
     12 - 13 Series . . . . . 6 - 7  
     14 - 15 Series . . . . . 8 - 9  
     16 - 17 Series . . . . . 10 - 11  
     18 - 20 Series . . . . . 12 - 13  
     22 - 24 Series . . . . . 14 - 15  
     26 - 29 Series . . . . . 16 - 17  
     32 Series . . . . . 18

## T-A® Drilling System

T-A System Overview . . . . . 20  
 Product Nomenclature . . . . . 21  
     0 Series . . . . . 22 - 25  
     1 Series . . . . . 26 - 29  
     2 Series . . . . . 30 - 33  
     3 Series . . . . . 34 - 36  
 Deep Hole Drilling Guidelines . . . . . 37

## Recommended Cutting Data

GEN3SYS XT Pro System . . . . . 38 - 39  
 T-A System . . . . . 40 - 41

### Reference Icons

The following icons will appear throughout the catalog to help you navigate between products.

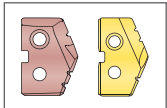

#### Corresponding T-A Inserts

Refers to the corresponding T-A insert items that connect with each specific holder series



#### Corresponding T-A Holders

Refers to the corresponding T-A holder items that connect with each specific insert series



#### Setup / Assembly Information

Detailed instructions and information regarding the corresponding part(s)

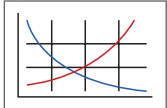

#### Recommended Cutting Data

Speed and feed recommendations for optimum and safe drilling

Series	GEN3SYS XT Pro Diameter Range	
	Imperial (inch)	Metric (mm)
12	0.4724 - 0.5117	12.00 - 12.99
13	0.5118 - 0.5511	13.00 - 13.99
14	0.5512 - 0.5905	14.00 - 14.99
15	0.5906 - 0.6298	15.00 - 15.99
16	0.6299 - 0.6692	16.00 - 16.99
17	0.6693 - 0.7086	17.00 - 17.99
18	0.7087 - 0.7873	18.00 - 19.99
20	0.7874 - 0.8660	20.00 - 21.99
22	0.8661 - 0.9448	22.00 - 23.99
24	0.9449 - 1.0235	24.00 - 25.99
26	1.0236 - 1.1416	26.00 - 28.99
29	1.1417 - 1.2597	29.00 - 31.99
32	1.2598 - 1.3780	32.00 - 35.00

Series	T-A Diameter Range	
	Imperial (inch)	Metric (mm)
0	0.511 - 0.695	12.98 - 17.65
1	0.690 - 0.960	17.53 - 24.38
2	0.961 - 1.380	24.41 - 35.05
3	1.353 - 1.882	34.36 - 47.80





## Structural Steel Drilling

### Achieving Optimal Results in Structural Steel

Drilling in structural steel materials can be a difficult process, and achieving optimal results becomes a major issue. Allied Machine's structural steel drilling solutions have been specifically designed to produce the best results in the toughest materials. With solutions in both the T-A® and GEN3SYS® XT Pro product lines, you have multiple options to solve your application problems.



### Insert Style Comparison

	 GEN3SYS® XT Pro Structural Steel	 Original T-A® Thin Wall	 Original T-A® Notch Point®	 Original T-A® 150° Structural Steel	 GEN2 T-A® High Efficiency
High penetration	<input checked="" type="checkbox"/>				
Material less than 7/16" thick		<input checked="" type="checkbox"/>			
Material over 7/16" thick	<input checked="" type="checkbox"/>		<input checked="" type="checkbox"/>	<input checked="" type="checkbox"/>	<input checked="" type="checkbox"/>
Reduced exit burr			<input checked="" type="checkbox"/>	<input checked="" type="checkbox"/>	
Includes Notch Point® geometry			<input checked="" type="checkbox"/>	<input checked="" type="checkbox"/>	<input checked="" type="checkbox"/>
Available from carbide	<input checked="" type="checkbox"/>				<input checked="" type="checkbox"/>
Stocked in common sizes for the Structural Steel industry	<input checked="" type="checkbox"/>	<input checked="" type="checkbox"/>	<input checked="" type="checkbox"/>	<input checked="" type="checkbox"/>	<input checked="" type="checkbox"/>

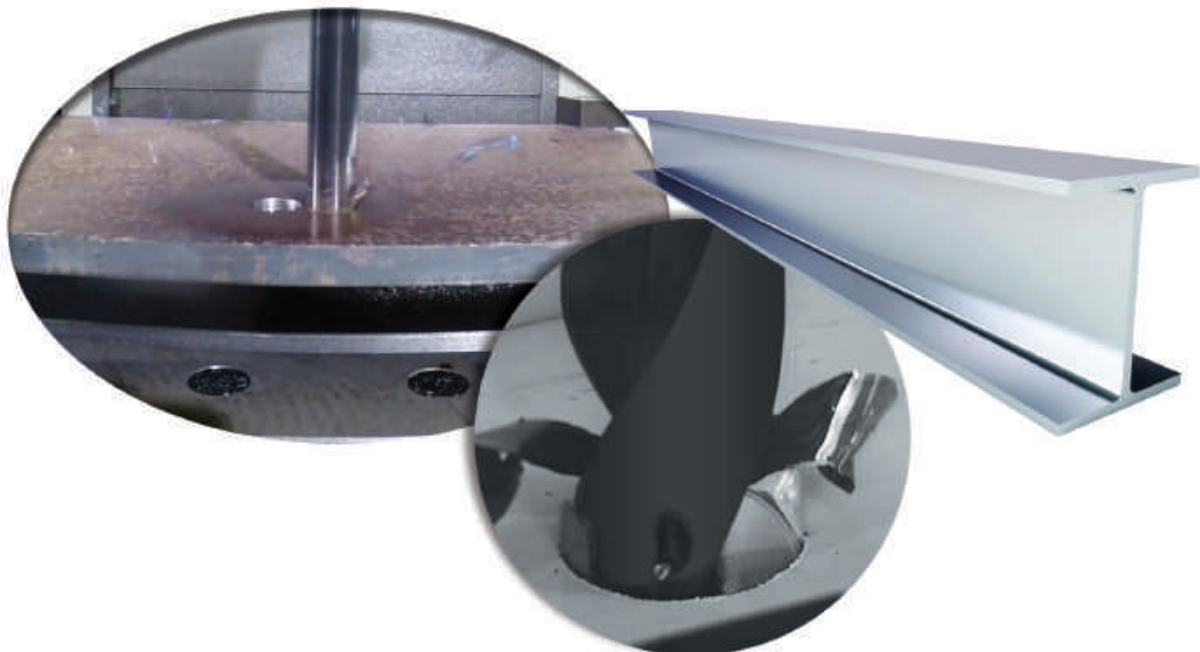



Case Study Example

# CASE STUDY

**Project Profile:** Structural Steel I-Beam Construction  
**Tooling Solution:** T-A® Structural Steel Drilling System

**The Problem:**  
 Previously, the customer was using a competitor spade drill running at the following parameters:

- 650 RPM
- 0.010 IPR (0.25 mm/rev)
- 6.5 IPM (165.1 mm/min)

The tool drilled a 0.875" (22.23mm) diameter hole to a 0.4375" (11.11mm) depth. The drill had a tool life of **only 20 holes**.

The poor tool performance was brought to the attention of the technician, who was familiar with Allied Machine products. The following day, Allied Machine tooling was brought in for testing. The customer needed improvement in the tool life of the inserts.

**The Solution:**  
 Allied Machine recommended the T-A Structural Steel Drilling System.

- **Insert** = 151A-0028-TW (#1 series T-A insert with TiAlN coating and Thin Wall geometry)
- **Holder** = 25010H-004IS052 (#1 series T-A holder with #4 Morse Taper shank and helical flute)

The tool ran at the following parameters:

- 440 RPM
- 0.010 IPR (0.25 mm/rev)
- 4.4 IPM (111.7 mm/min)

The tool achieved the desired diameter and depth. But most of all, the tool produced **1,500 holes**.

**Summary:**  
 The customer was able to take advantage of Allied Machine's vast experience in the structural steel drilling niche. Allied's wide variety of stocked solutions for specific customer problems allows for a remarkable increase in tool life.

The T-A Structural Steel Drilling System defeated the competition, decreasing the total cost-per-hole from \$2.02 to just \$0.22. This reduction resulted in a **savings of 89%** for the customer.



## The PROOF is in the NUMBERS

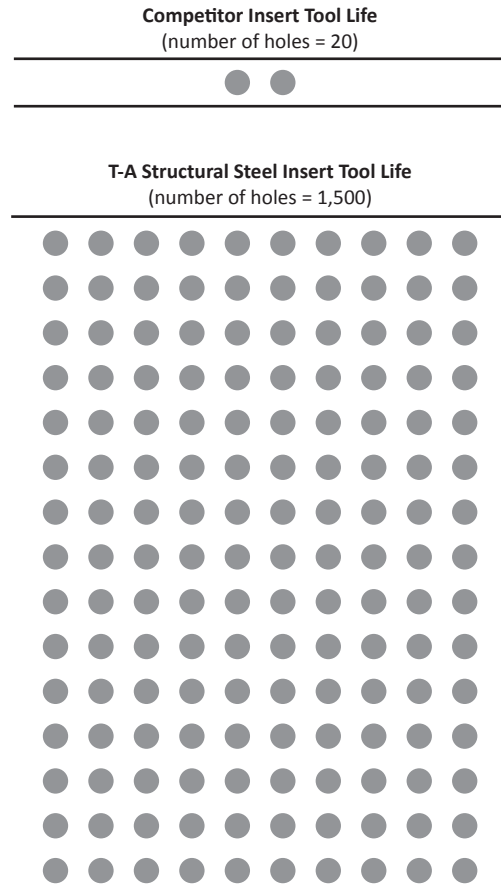

Overall **SAVINGS** of **89%**



**PREMIUM SOLUTION**



A  
DRILLING  
B  
BORING  
C  
REAMING  
D  
BURNISHING  
E  
THREADING  
X  
SPECIALS

GEN3SYS® XT Pro Structural Steel Drilling System

A  
DRILLING  
B  
BORING  
C  
REAMING  
D  
BURNISHING  
E  
THREADING  
X  
SPECIALS



GEN3SYS® XT Pro **ST**  
STRUCTURAL STEEL ENHANCEMENTS

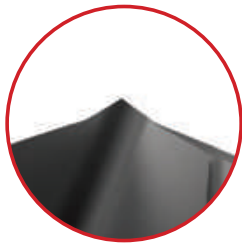
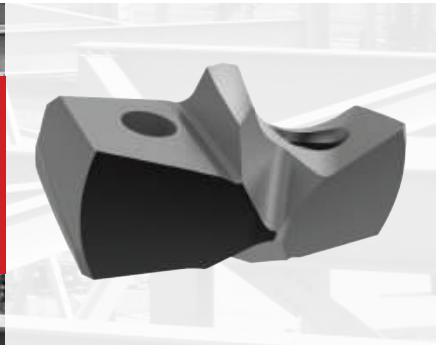

**New Point Design**

Increases stability without hindering penetration

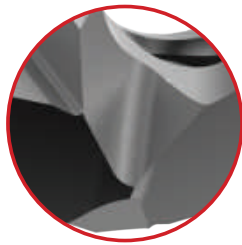

**Redesigned Insert**

Provides consistent performance and adds durability

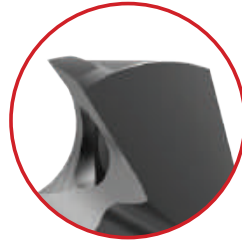

**Improved Geometry**

Extends tool life and increases insert strength without increasing horsepower consumption



**AM420**

**AM420 Coating**

Increases heat threshold and extends tool life

**Get the Consistency You Need**

The challenge of drilling structural steel materials is about to get a whole lot easier. Developed through a rigorous and thorough testing process, the modified and improved XTST insert is a product of innovation.

Achieve the **consistent performance** you need while matching or even exceeding your current parameters.

**Tough Drilling is Tough No More**

Structural steel applications can prove to be difficult to machine, so you need a drill that's been put through the fire to ensure it can conquer those challenging applications.

Rigorous testing and countless hours of design and programming make the XT Pro structural steel insert the optimal drill for structural steel applications.

- Diameter range: 12mm - 35mm
- Holders available in 3xD, 5xD, and 7xD lengths
- Flanged shank with flat



3xD

5xD

7xD



**NOTICE:** Structural Steel GEN3SYS holders are specifically designed to be used only with XTST geometry inserts. Using other GEN3SYS XT or XT Pro insert geometries in these holders could lead to chip packing and tool failure. Contact Application Engineering for questions regarding proper use of tools.

## GEN3SYS® XT Pro Drill Nomenclature

### GEN3SYS XT Pro Drill Inserts

<b>XT</b>	<b>ST</b>	<b>20</b>	–	<b>20.00</b>
1	2	3		4

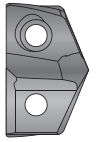

1. XT Pro Drill Insert	2. Geometry	3. Series	4. Diameter (mm)															
XT = XT Pro insert	ST = Structural Steel	<table border="0"> <tr> <td><b>12</b> = 12 series</td> <td><b>17</b> = 17 series</td> <td><b>26</b> = 26 series</td> </tr> <tr> <td><b>13</b> = 13 series</td> <td><b>18</b> = 18 series</td> <td><b>29</b> = 29 series</td> </tr> <tr> <td><b>14</b> = 14 series</td> <td><b>20</b> = 20 series</td> <td><b>32</b> = 32 series</td> </tr> <tr> <td><b>15</b> = 15 series</td> <td><b>22</b> = 22 series</td> <td></td> </tr> <tr> <td><b>16</b> = 16 series</td> <td><b>24</b> = 24 series</td> <td></td> </tr> </table>	<b>12</b> = 12 series	<b>17</b> = 17 series	<b>26</b> = 26 series	<b>13</b> = 13 series	<b>18</b> = 18 series	<b>29</b> = 29 series	<b>14</b> = 14 series	<b>20</b> = 20 series	<b>32</b> = 32 series	<b>15</b> = 15 series	<b>22</b> = 22 series		<b>16</b> = 16 series	<b>24</b> = 24 series		For complete list of diameter ranges by series, see contents page.
<b>12</b> = 12 series	<b>17</b> = 17 series	<b>26</b> = 26 series																
<b>13</b> = 13 series	<b>18</b> = 18 series	<b>29</b> = 29 series																
<b>14</b> = 14 series	<b>20</b> = 20 series	<b>32</b> = 32 series																
<b>15</b> = 15 series	<b>22</b> = 22 series																	
<b>16</b> = 16 series	<b>24</b> = 24 series																	

#### Reference Key

Symbol	Attribute
$D_1$	Insert diameter

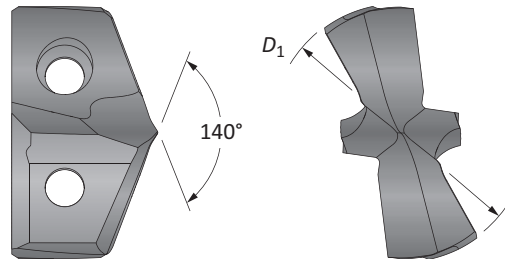

Sizes not shown are available upon request.  
When ordering, please follow the example below:

<b>Imperial:</b>	0.7913", 20 series = use Part No. <b>XTST20-20.10</b>
<b>Metric:</b>	20.10mm, 20 series = use Part No. <b>XTST20-20.10</b>

### GEN3SYS Structural Steel Drill Holders

<b>ST</b>	<b>03</b>	<b>12</b>	<b>0</b>	–	<b>20</b>	<b>FM</b>
1	2	3	4		5	6

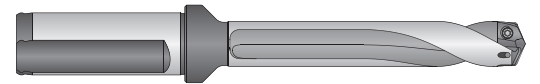

1. Holder	2. Length	3. Series	4. Body Diameter															
ST = Structural steel holder	<b>03</b> = 3x Diameter <b>05</b> = 5x Diameter <b>07</b> = 7x Diameter	<table border="0"> <tr> <td><b>12</b> = 12 series</td> <td><b>17</b> = 17 series</td> <td><b>26</b> = 26 series</td> </tr> <tr> <td><b>13</b> = 13 series</td> <td><b>18</b> = 18 series</td> <td><b>29</b> = 29 series</td> </tr> <tr> <td><b>14</b> = 14 series</td> <td><b>20</b> = 20 series</td> <td><b>32</b> = 32 series</td> </tr> <tr> <td><b>15</b> = 15 series</td> <td><b>22</b> = 22 series</td> <td></td> </tr> <tr> <td><b>16</b> = 16 series</td> <td><b>24</b> = 24 series</td> <td></td> </tr> </table>	<b>12</b> = 12 series	<b>17</b> = 17 series	<b>26</b> = 26 series	<b>13</b> = 13 series	<b>18</b> = 18 series	<b>29</b> = 29 series	<b>14</b> = 14 series	<b>20</b> = 20 series	<b>32</b> = 32 series	<b>15</b> = 15 series	<b>22</b> = 22 series		<b>16</b> = 16 series	<b>24</b> = 24 series		<b>0</b> = Standard <b>5</b> = Oversized
<b>12</b> = 12 series	<b>17</b> = 17 series	<b>26</b> = 26 series																
<b>13</b> = 13 series	<b>18</b> = 18 series	<b>29</b> = 29 series																
<b>14</b> = 14 series	<b>20</b> = 20 series	<b>32</b> = 32 series																
<b>15</b> = 15 series	<b>22</b> = 22 series																	
<b>16</b> = 16 series	<b>24</b> = 24 series																	

5. Shank Diameter	
Imperial (in)	Metric (mm)
<b>063</b> = 5/8"	<b>125</b> = 1-1/4"
<b>075</b> = 3/4"	<b>150</b> = 1-1/2"
<b>100</b> = 1"	
	<b>16</b> = 16mm <b>32</b> = 32mm
	<b>20</b> = 20mm <b>40</b> = 40mm
	<b>25</b> = 25mm

6. Shank Style
<b>F</b> = Flanged with flat
<b>FM</b> = Flanged metric with flat
<b>C</b> = Cylindrical (no flat)
<b>CM</b> = Cylindrical metric (no flat)

#### Reference Key

Symbol	Attribute
$D_2$	Shank diameter
$L_1$	Overall length
$L_2$	Drill depth
$L_3$	Holder reference length
$L_4$	Holder body length
$L_7$	Shank length
$P_1$	Rear pipe tap

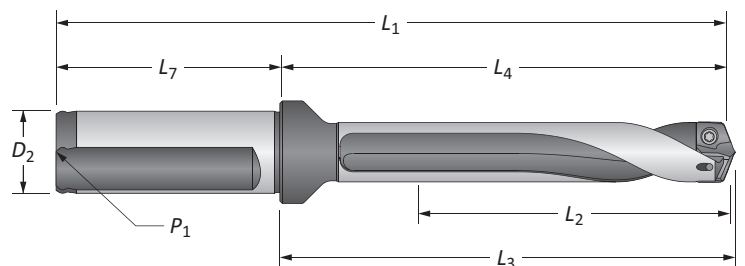

## GEN3SYS® XT Pro Structural Steel Drilling System

12 Series | Diameter Range: 0.4724" - 0.5117" (12.00mm - 12.99mm)

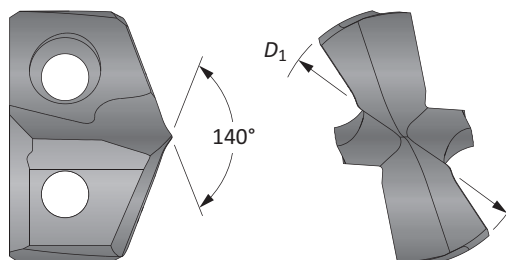

### Inserts

Fractional Equivalent	Insert $D_1$ inch	$D_1$ mm	 XTST Part No.
–	0.4724	12.00	XTST12-12.00

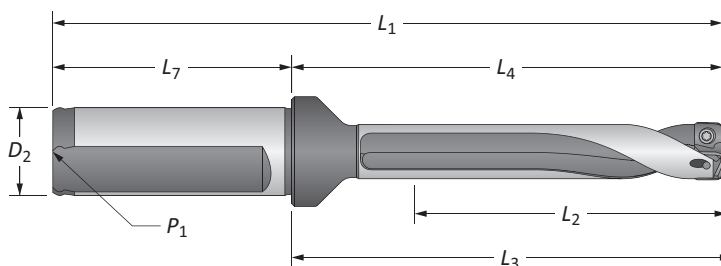





### HOLDERS

Length	Body				Shank				Flat	Part No.
	$L_2$	$L_4$	$L_3$	$L_1$	$L_7$	$D_2$	$P_1$			
<b>i</b> 3xD	1-17/32	2-5/8	2-45/64	4-21/32	2-1/32	3/4	1/8	YES	ST03120-075F	
<b>i</b> 5xD	2-9/16	3-41/64	3-47/64	5-43/64	2-1/32	3/4	1/8	YES	ST05120-075F	
<b>i</b> 7xD	3-37/64	4-43/64	4-3/4	6-45/64	2-1/32	3/4	1/8	YES	ST07120-075F	
<b>m</b> 3xD	39.0	68.8	68.8	118.8	50	20	1/8*	YES	ST03120-20FM	
<b>m</b> 5xD	65.0	94.8	94.8	144.8	50	20	1/8*	YES	ST05120-20FM	
<b>m</b> 7xD	90.9	120.8	120.8	170.8	50	20	1/8*	YES	ST07120-20FM	

\*Thread to BSP and ISO 7-1

### Connection Accessories

 Insert Screws	 Nylon Locking Screws	 Insert Driver	 Preset Torque Hand Driver	 Replacement Tips	Admissible Tightening Torque*
7247-IP7-1	7247N-IP7-1	8IP-7	8IP-7TL	8IP-7B	7.4 in-lbs (84 N-cm)

\*Tightening torques are calculated with a friction coefficient of  $\mu = 0.14$  and develop 90% of ultimate yield strength

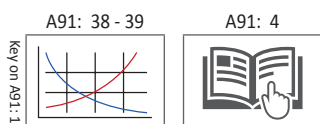

**i** = Imperial (in)  
**m** = Metric (mm)

Inserts sold in multiples of 1 | Screws sold in multiples of 10

**NOTICE:** Structural Steel GEN3SYS holders are specifically designed to be used only with XTST geometry inserts. Using other GEN3SYS XT or XT Pro insert geometries in these holders could lead to chip packing and tool failure. Contact Application Engineering for questions regarding proper use of tools.

## GEN3SYS® XT Pro Structural Steel Drilling System

13 Series | Diameter Range: 0.5118" - 0.5511" (13.00mm - 13.99mm)

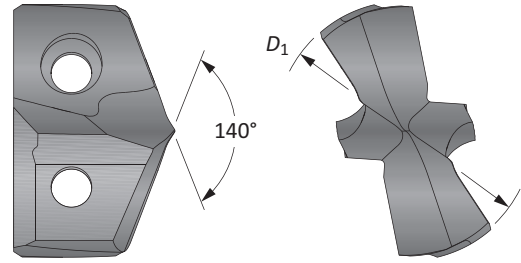

### Inserts

Fractional Equivalent	Insert $D_1$ inch	$D_1$ mm	 XTST Part No.
-	0.5118	13.00	XTST13-13.00

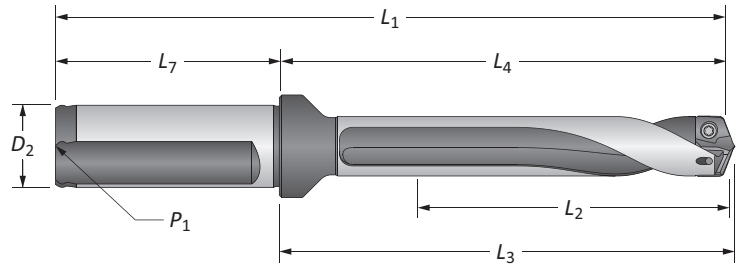





### Holders

	Length	Body				Shank				Part No.
		$L_2$	$L_4$	$L_3$	$L_1$	$L_7$	$D_2$	$P_1$	Flat	
i	3xD	1-21/32	2-23/32	2-13/16	4-3/4	2-1/32	3/4	1/8	YES	ST03130-075F
	5xD	2-3/4	3-53/64	3-29/32	5-55/64	2-1/32	3/4	1/8	YES	ST05130-075F
	7xD	3-55/64	4-15/16	5-1/32	6-31/32	2-1/32	3/4	1/8	YES	ST07130-075F
m	3xD	42.1	69.1	71.3	120.7	50	20	1/8*	YES	ST03130-20FM
	5xD	69.9	97.2	99.4	148.8	50	20	1/8*	YES	ST05130-20FM
	7xD	97.9	125.4	127.6	177.0	50	20	1/8*	YES	ST07130-20FM

\*Thread to BSP and ISO 7-1

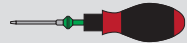
### Connection Accessories

 Insert Screws	 Nylon Locking Screws	 Insert Driver	 Preset Torque Hand Driver	 Replacement Tips	Admissible Tightening Torque*
7247-IP7-1	7247N-IP7-1	8IP-7	8IP-7TL	8IP-7B	7.4 in-lbs (84 N-cm)

\*Tightening torques are calculated with a friction coefficient of  $\mu = 0.14$  and develop 90% of ultimate yield strength

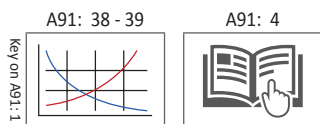

i = Imperial (in)  
m = Metric (mm)

Inserts sold in multiples of 1 | Screws sold in multiples of 10

**NOTICE:** Structural Steel GEN3SYS holders are specifically designed to be used only with XTST geometry inserts. Using other GEN3SYS XT or XT Pro insert geometries in these holders could lead to chip packing and tool failure. Contact Application Engineering for questions regarding proper use of tools.

## GEN3SYS® XT Pro Structural Steel Drilling System

14 Series | Diameter Range: 0.5512" - 0.5905" (14.00mm - 14.99mm)

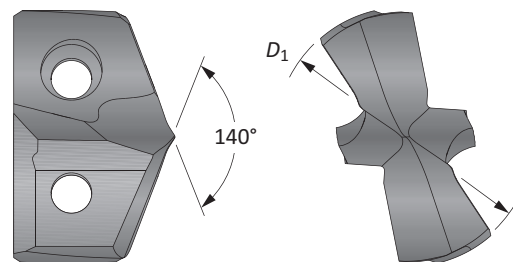

### Inserts

Fractional Equivalent	Insert $D_1$ inch	$D_1$ mm	 XTST Part No.
–	0.5512	14.00	XTST14-14.00
9/16	0.5625	14.29	XTST14-14.29

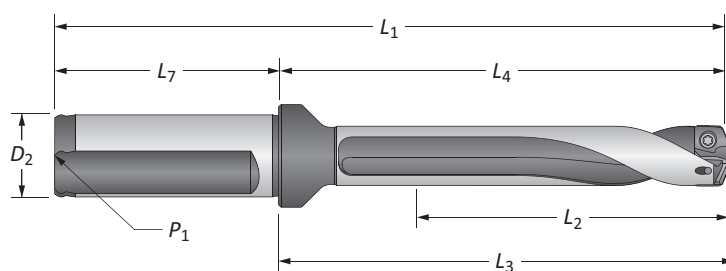





### Holders

Length	Body				Shank				Flat	Part No.
	$L_2$	$L_4$	$L_3$	$L_1$	$L_7$	$D_2$	$P_1$			
<b>i</b> 3xD	1-25/32	2-27/32	2-61/64	4-7/8	2-1/32	3/4	1/8	YES	ST03140-075F	
<b>i</b> 5xD	2-61/64	4-1/32	4-1/8	6-1/16	2-1/32	3/4	1/8	YES	ST05140-075F	
<b>i</b> 7xD	4-9/64	5-13/64	5-5/16	7-15/64	2-1/32	3/4	1/8	YES	ST07140-075F	
<b>m</b> 3xD	45.0	72.4	75.0	122.4	50	20	1/8*	YES	ST03140-20FM	
<b>m</b> 5xD	75.0	102.4	104.9	152.4	50	20	1/8*	YES	ST05140-20FM	
<b>m</b> 7xD	104.9	132.3	134.9	182.3	50	20	1/8*	YES	ST07140-20FM	

\*Thread to BSP and ISO 7-1

### Connection Accessories

 Insert Screws	 Nylon Locking Screws	 Insert Driver	 Preset Torque Hand Driver	 Replacement Tips	Admissible Tightening Torque*
7247-IP7-1	7247N-IP7-1	8IP-7	8IP-7TL	8IP-7B	7.4 in-lbs (84 N-cm)

\*Tightening torques are calculated with a friction coefficient of  $\mu = 0.14$  and develop 90% of ultimate yield strength

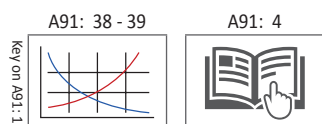

**i** = Imperial (in)  
**m** = Metric (mm)

Inserts sold in multiples of 1 | Screws sold in multiples of 10

**NOTICE:** Structural Steel GEN3SYS holders are specifically designed to be used only with XTST geometry inserts. Using other GEN3SYS XT or XT Pro insert geometries in these holders could lead to chip packing and tool failure. Contact Application Engineering for questions regarding proper use of tools.

## GEN3SYS® XT Pro Structural Steel Drilling System

15 Series | Diameter Range: 0.5906" - 0.6298" (15.00mm - 15.99mm)

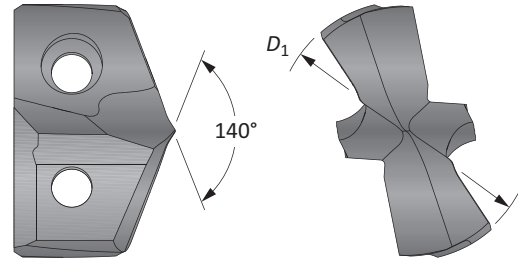
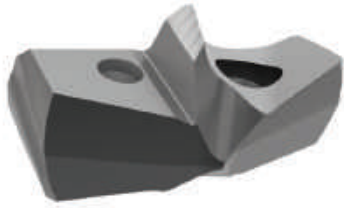

### Inserts

Fractional Equivalent	Insert $D_1$ inch	$D_1$ mm	 XTST Part No.
	0.5906	15.00	XTST15-15.00
5/8	0.6250	15.88	XTST15-15.88

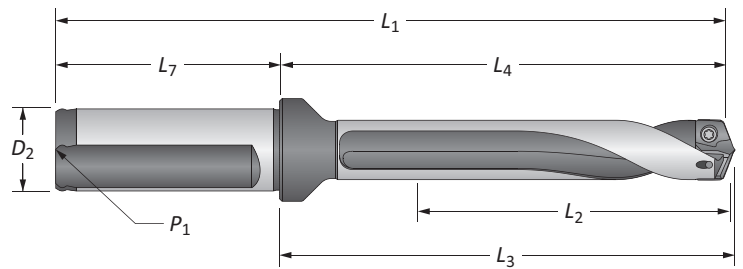





### Holders

Length	Body				Shank				Flat	Part No.
	$L_2$	$L_4$	$L_3$	$L_1$	$L_7$	$D_2$	$P_1$			
<b>i</b> 3xD	1-57/64	2-61/64	3-3/64	4-63/64	2-1/32	3/4	1/8	YES	ST03150-075F	
5xD	3-5/32	4-7/32	4-5/16	6-1/4	2-1/32	3/4	1/8	YES	ST05150-075F	
7xD	4-27/64	5-15/32	5-37/64	7-1/2	2-1/32	3/4	1/8	YES	ST07150-075F	
<b>m</b> 3xD	48.0	75.1	77.6	125.1	50	20	1/8*	YES	ST03150-20FM	
5xD	80.0	107.0	109.6	157.0	50	20	1/8*	YES	ST05150-20FM	
7xD	111.9	139.0	141.6	189.0	50	20	1/8*	YES	ST07150-20FM	

\*Thread to BSP and ISO 7-1

### Connection Accessories

 Insert Screws	 Nylon Locking Screws	 Insert Driver	 Preset Torque Hand Driver	 Replacement Tips	Admissible Tightening Torque*
7247-IP7-1	7247N-IP7-1	8IP-7	8IP-7TL	8IP-7B	7.4 in-lbs (84 N-cm)

\*Tightening torques are calculated with a friction coefficient of  $\mu = 0.14$  and develop 90% of ultimate yield strength

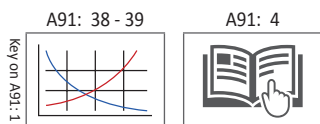

**i** = Imperial (in)  
**m** = Metric (mm)

Inserts sold in multiples of 1 | Screws sold in multiples of 10

**NOTICE:** Structural Steel GEN3SYS holders are specifically designed to be used only with XTST geometry inserts. Using other GEN3SYS XT or XT Pro insert geometries in these holders could lead to chip packing and tool failure. Contact Application Engineering for questions regarding proper use of tools.

# GEN3SYS® XT Pro Structural Steel Drilling System

16 Series | Diameter Range: 0.6299" - 0.6692" (16.00mm - 16.99mm)

A  
DRILLING

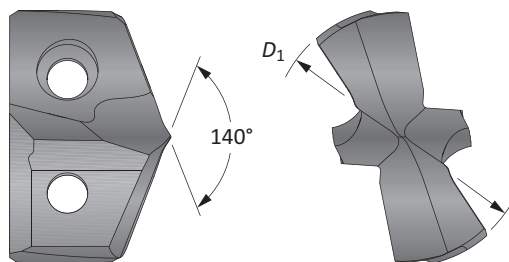
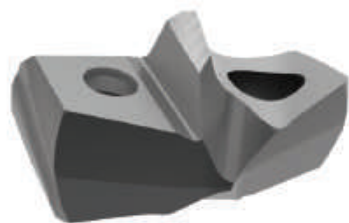

B  
BORING

### Inserts

Fractional Equivalent	Insert $D_1$ inch	$D_1$ mm	 XTST Part No.
-	0.6299	16.00	XTST16-16.00

C  
REAMING

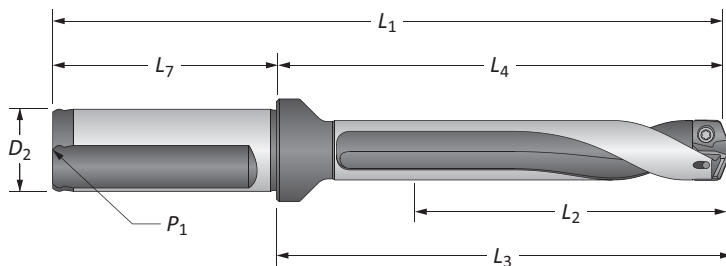

D  
BURNISHING





### Holders

Length	Body					Shank				Flat	Part No.
	$L_2$	$L_4$	$L_3$	$L_1$	$L_7$	$D_2$	$P_1$				
<b>i</b> 3xD	3-1/64	3-13/64	3-5/16	5-15/64	2-1/32	3/4	1/8	YES	ST03160-075F		
<b>i</b> 5xD	3-23/64	4-17/32	4-21/32	6-9/16	2-1/32	3/4	1/8	YES	ST05160-075F		
<b>i</b> 7xD	4-11/16	5-7/8	5-63/64	7-29/32	2-1/32	3/4	1/8	YES	ST07160-075F		
<b>m</b> 3xD	51.0	81.3	84.2	131.3	50	20	1/8*	YES	ST03160-20FM		
<b>m</b> 5xD	84.9	115.3	118.2	165.3	50	20	1/8*	YES	ST05160-20FM		
<b>m</b> 7xD	118.9	149.3	152.2	199.3	50	20	1/8*	YES	ST07160-20FM		

\*Thread to BSP and ISO 7-1

F  
THREADING

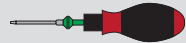
### Connection Accessories

 Insert Screws	 Nylon Locking Screws	 Insert Driver	 Preset Torque Hand Driver	 Replacement Tips	Admissible Tightening Torque*
72556-IP8-1	72556N-IP8-1	8IP-8	8IP-8TL	8IP-8B	15.5 in-lbs (175 N-cm)

\*Tightening torques are calculated with a friction coefficient of  $\mu = 0.14$  and develop 90% of ultimate yield strength

X  
SPECIALS

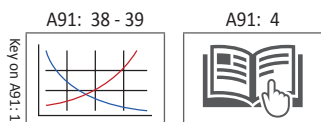

**i** = Imperial (in)  
**m** = Metric (mm)

Inserts sold in multiples of 1 | Screws sold in multiples of 10

**NOTICE:** Structural Steel GEN3SYS holders are specifically designed to be used only with XTST geometry inserts. Using other GEN3SYS XT or XT Pro insert geometries in these holders could lead to chip packing and tool failure. Contact Application Engineering for questions regarding proper use of tools.



## GEN3SYS® XT Pro Structural Steel Drilling System

17 Series | Diameter Range: 0.6693" - 0.7086" (17.00mm - 17.99mm)

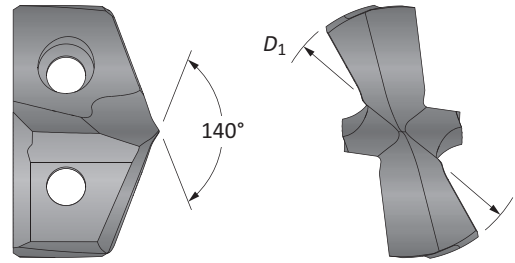
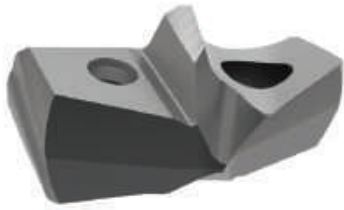

### Inserts

Fractional Equivalent	Insert $D_1$ inch	$D_1$ mm	 XTST Part No.
–	0.6693	17.00	<b>XTST17-17.00</b>
11/16	0.6875	17.46	<b>XTST17-17.46</b>

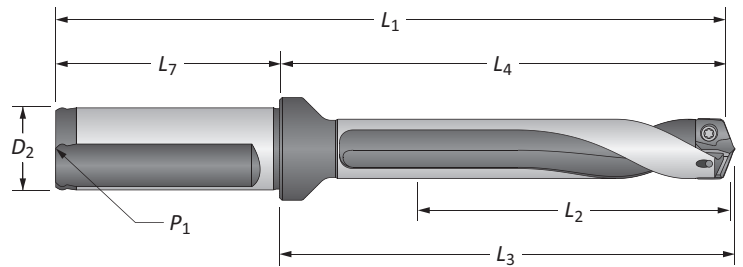





### Holders

Length	Body				Shank				Flat	Part No.
	$L_2$	$L_4$	$L_3$	$L_1$	$L_7$	$D_2$	$P_1$			
<b>i</b> 3xD	2-1/8	3-5/16	3-27/64	5-11/32	2-1/32	3/4	1/8	YES	<b>ST03170-075F</b>	
5xD	3-35/64	4-23/32	4-27/32	6-3/4	2-1/32	3/4	1/8	YES	<b>ST05170-075F</b>	
7xD	4-31/32	6-9/64	6-1/4	8-11/64	2-1/32	3/4	1/8	YES	<b>ST07170-075F</b>	
<b>m</b> 3xD	54.0	84.1	87.0	134.1	50	20	1/8*	YES	<b>ST03170-20FM</b>	
5xD	89.9	120.0	122.9	170.0	50	20	1/8*	YES	<b>ST05170-20FM</b>	
7xD	125.9	156.0	158.9	206.0	50	20	1/8*	YES	<b>ST07170-20FM</b>	

\*Thread to BSP and ISO 7-1

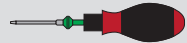
### Connection Accessories

 Insert Screws	 Nylon Locking Screws	 Insert Driver	 Preset Torque Hand Driver	 Replacement Tips	Admissible Tightening Torque*
72567-IP8-1	72567N-IP8-1	8IP-8	8IP-8TL	8IP-8B	15.5 in-lbs (175 N-cm)

\*Tightening torques are calculated with a friction coefficient of  $\mu = 0.14$  and develop 90% of ultimate yield strength

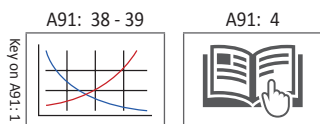

**i** = Imperial (in)  
**m** = Metric (mm)

Inserts sold in multiples of 1 | Screws sold in multiples of 10

**NOTICE:** Structural Steel GEN3SYS holders are specifically designed to be used only with XTST geometry inserts. Using other GEN3SYS XT or XT Pro insert geometries in these holders could lead to chip packing and tool failure. Contact Application Engineering for questions regarding proper use of tools.

## GEN3SYS® XT Pro Structural Steel Drilling System

18 Series | Diameter Range: 0.7087" - 0.7873" (18.00mm - 19.99mm)

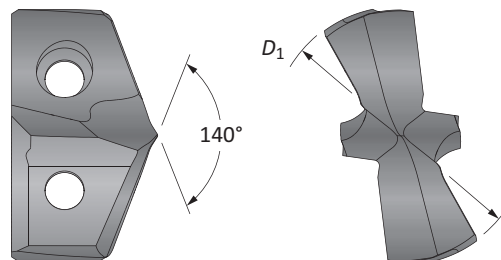
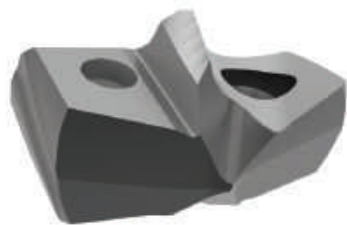

### Inserts

Fractional Equivalent	Insert		 <b>XTST Part No.</b>
	$D_1$ inch	$D_1$ mm	
-	0.7087	18.00	<b>XTST18-18.00</b>
-	0.7480	19.00	<b>XTST18-19.00</b>

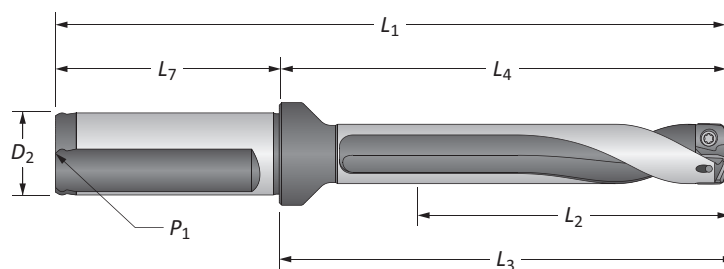





### Holders

Length	Body					Shank				Part No.
	$L_2$	$L_4$	$L_3$	$L_1$	$L_7$	$D_2$	$P_1$	Flat		
3xD	2-3/8	3-45/64	3-53/64	5-63/64	2-9/32	1	1/8	YES	<b>ST03180-100F</b>	
5xD	3-15/16	5-9/32	5-25/64	7-9/16	2-9/32	1	1/8	YES	<b>ST05180-100F</b>	
7xD	5-33/64	6-27/32	6-31/32	9-1/8	2-9/32	1	1/8	YES	<b>ST07180-100F</b>	
3xD	60.0	94.0	97.1	144.0	50	20	1/8*	YES	<b>ST03180-20FM</b>	
5xD	99.9	134.0	137.1	184.0	50	20	1/8*	YES	<b>ST05180-20FM</b>	
7xD	139.9	174.0	177.1	224.0	50	20	1/8*	YES	<b>ST07180-20FM</b>	

\*Thread to BSP and ISO 7-1

### Connection Accessories

 <b>Insert Screws</b>	 <b>Nylon Locking Screws</b>	 <b>Insert Driver</b>	 <b>Preset Torque Hand Driver</b>	 <b>Replacement Tips</b>	<b>Admissible Tightening Torque*</b>
7375-IP9-1	7375N-IP9-1	8IP-9	8IP-9TL	8IP-9B	27.0 in-lbs (305 N-cm)

\*Tightening torques are calculated with a friction coefficient of  $\mu = 0.14$  and develop 90% of ultimate yield strength

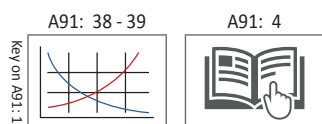

**i** = Imperial (in)  
**m** = Metric (mm)

Inserts sold in multiples of 1 | Screws sold in multiples of 10

**NOTICE:** Structural Steel GEN3SYS holders are specifically designed to be used only with XTST geometry inserts. Using other GEN3SYS XT or XT Pro insert geometries in these holders could lead to chip packing and tool failure. Contact Application Engineering for questions regarding proper use of tools.

## GEN3SYS® XT Pro Structural Steel Drilling System

20 Series | Diameter Range: 0.7874" - 0.8660" (20.00mm - 21.99mm)

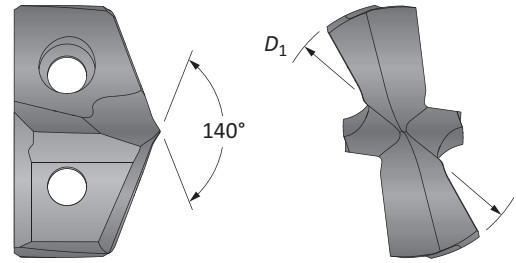
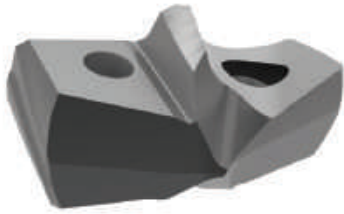

### Inserts

Fractional Equivalent	Insert		 XTST Part No.
	$D_1$ inch	$D_1$ mm	
-	0.7874	20.00	<b>XTST20-20.00</b>
13/16	0.8125	20.64	<b>XTST20-20.64</b>
-	0.8268	21.00	<b>XTST20-21.00</b>
-	0.8594	21.82	<b>XTST20-21.82</b>

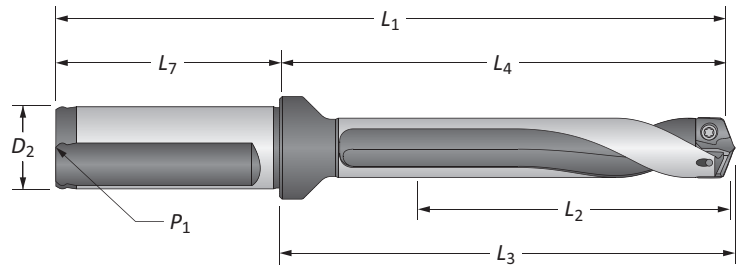





### Holders

Length	Body				Shank				Flat	Part No.
	$L_2$	$L_4$	$L_3$	$L_1$	$L_7$	$D_2$	$P_1$			
<b>i</b> 3xD	2-17/32	3-15/16	4-1/16	6-7/32	2-9/32	1	1/8	YES	<b>ST03200-100F</b>	
5xD	4-11/32	5-43/64	5-51/64	7-61/64	2-9/32	1	1/8	YES	<b>ST05200-100F</b>	
7xD	6-1/16	7-13/32	7-17/32	9-11/16	2-9/32	1	1/8	YES	<b>ST07200-100F</b>	
<b>m</b> 3xD	66.0	100.1	103.3	156.1	56	25	1/8*	YES	<b>ST03200-25FM</b>	
5xD	110.0	144.1	147.2	200.1	56	25	1/8*	YES	<b>ST05200-25FM</b>	
7xD	153.9	188.1	191.2	244.1	56	25	1/8*	YES	<b>ST07200-25FM</b>	

\*Thread to BSP and ISO 7-1

### Connection Accessories

 Insert Screws	 Nylon Locking Screws	 Insert Driver	 Preset Torque Hand Driver	 Replacement Tips	Admissible Tightening Torque*
7375-IP9-1	7375N-IP9-1	8IP-9	8IP-9TL	8IP-9B	27.0 in-lbs (305 N-cm)

\*Tightening torques are calculated with a friction coefficient of  $\mu = 0.14$  and develop 90% of ultimate yield strength

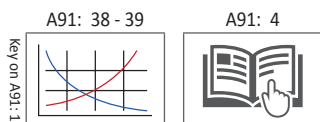

**i** = Imperial (in)  
**m** = Metric (mm)

Inserts sold in multiples of 1 | Screws sold in multiples of 10

**NOTICE:** Structural Steel GEN3SYS holders are specifically designed to be used only with XTST geometry inserts. Using other GEN3SYS XT or XT Pro insert geometries in these holders could lead to chip packing and tool failure. Contact Application Engineering for questions regarding proper use of tools.

## GEN3SYS® XT Pro Structural Steel Drilling System

22 Series | Diameter Range: 0.8661" - 0.9448" (22.00mm - 23.99mm)

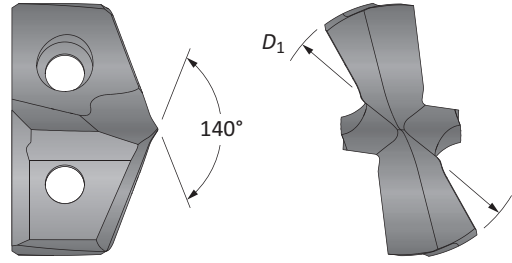

### Inserts

Fractional Equivalent	Insert D <sub>1</sub> inch	D <sub>1</sub> mm	XTST Part No.
-	0.8661	22.00	XTST22-22.00
7/8	0.8750	22.23	XTST22-22.23
-	0.9055	23.00	XTST22-23.00
15/16	0.9375	23.81	XTST22-23.81



XTST Part No.

XTST22-22.00

XTST22-22.23

XTST22-23.00

XTST22-23.81

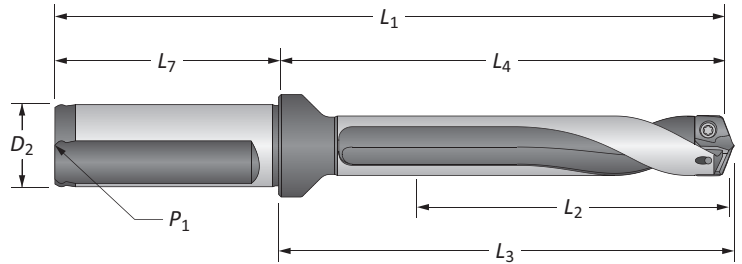

### Holders

Length	Body				Shank				Flat	Part No.
	L <sub>2</sub>	L <sub>4</sub>	L <sub>3</sub>	L <sub>1</sub>	L <sub>7</sub>	D <sub>2</sub>	P <sub>1</sub>			
3xD	2-53/64	4-9/64	4-9/32	6-27/64	2-9/32	1	1/8	YES	ST03220-100F	
3xD	2-53/64	4-9/64	4-9/32	6-27/64	2-9/32	1	1/8	YES	ST03225-100F**	
5xD	4-23/32	6-1/32	6-11/64	8-5/16	2-9/32	1	1/8	YES	ST05220-100F	
5xD	4-23/32	6-1/32	6-11/64	8-5/16	2-9/32	1	1/8	YES	ST05225-100F**	
7xD	6-39/64	7-59/64	8-1/16	10-13/64	2-9/32	1	1/8	YES	ST07220-100F	
7xD	6-39/64	7-59/64	8-1/16	10-13/64	2-9/32	1	1/8	YES	ST07225-100F**	
3xD	72.0	105.3	108.7	161.3	56	25	1/8*	YES	ST03220-25FM	
3xD	72.0	105.3	108.7	161.3	56	25	1/8*	YES	ST03225-25FM**	
5xD	119.9	153.3	156.7	209.3	56	25	1/8*	YES	ST05220-25FM	
5xD	119.9	153.3	156.7	209.3	56	25	1/8*	YES	ST05225-25FM**	
7xD	167.9	201.3	204.7	257.3	56	25	1/8*	YES	ST07220-25FM	
7xD	167.9	201.3	204.7	257.3	56	25	1/8*	YES	ST07225-25FM**	

\*Thread to BSP and ISO 7-1 | \*\*Oversized body holder (minimum drill diameter = 23mm)

### Connection Accessories

Insert Screws	Nylon Locking Screws	Insert Driver	Preset Torque Hand Driver	Replacement Tips	Admissible Tightening Torque*
739-IP9-1	739N-IP9-1	8IP-9	8IP-9TL	8IP-9B	27.0 in-lbs (305 N-cm)

\*Tightening torques are calculated with a friction coefficient of  $\mu = 0.14$  and develop 90% of ultimate yield strength

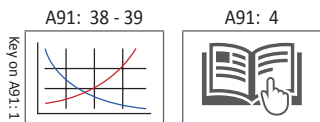

i = Imperial (in)  
m = Metric (mm)

Inserts sold in multiples of 1 | Screws sold in multiples of 10

**NOTICE:** Structural Steel GEN3SYS holders are specifically designed to be used only with XTST geometry inserts. Using other GEN3SYS XT or XT Pro insert geometries in these holders could lead to chip packing and tool failure. Contact Application Engineering for questions regarding proper use of tools.

## GEN3SYS® XT Pro Structural Steel Drilling System

24 Series | Diameter Range: 0.9449" - 1.0235" (24.00mm - 25.99mm)

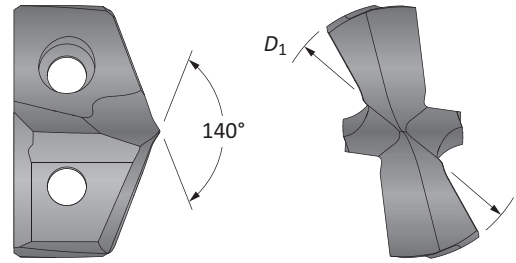
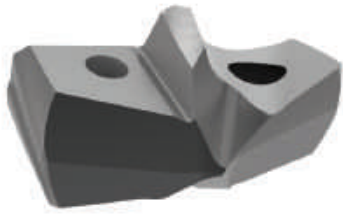

### Inserts

Fractional Equivalent	Insert $D_1$ inch	$D_1$ mm	 XTST Part No.
–	0.9449	24.00	<b>XTST24-24.00</b>
–	0.9685	24.60	<b>XTST24-24.60</b>
1	1.0000	25.40	<b>XTST24-25.40</b>
–	1.0150	25.78	<b>XTST24-25.78</b>

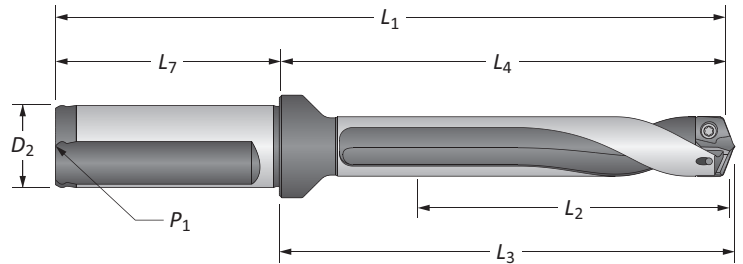





### Holders

Length	Body				Shank				Flat	Part No.
	$L_2$	$L_4$	$L_3$	$L_1$	$L_7$	$D_2$	$P_1$			
<b>i</b> 3xD	3-5/64	4-31/64	4-5/8	6-49/64	2-9/32	1	1/8	YES	<b>ST03240-100F</b>	
<b>i</b> 5xD	5-1/8	6-17/32	6-21/32	8-13/16	2-9/32	1	1/8	YES	<b>ST05240-100F</b>	
<b>i</b> 7xD	7-11/64	8-37/64	8-45/64	10-55/64	2-9/32	1	1/8	YES	<b>ST07240-100F</b>	
<b>m</b> 3xD	78.0	113.8	117.3	169.8	56	25	1/8*	YES	<b>ST03240-25FM</b>	
<b>m</b> 5xD	129.9	165.8	169.2	221.8	56	25	1/8*	YES	<b>ST05240-25FM</b>	
<b>m</b> 7xD	181.9	217.8	221.2	273.8	56	25	1/8*	YES	<b>ST07240-25FM</b>	

\*Thread to BSP and ISO 7-1

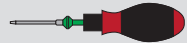
### Connection Accessories

 Insert Screws	 Nylon Locking Screws	 Insert Driver	 Preset Torque Hand Driver	 Replacement Tips	Admissible Tightening Torque*
739-IP9-1	739N-IP9-1	8IP-9	8IP-9TL	8IP-9B	27.0 in-lbs (305 N-cm)

\*Tightening torques are calculated with a friction coefficient of  $\mu = 0.14$  and develop 90% of ultimate yield strength

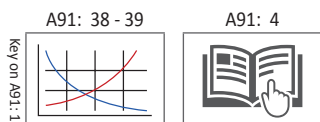

**i** = Imperial (in)  
**m** = Metric (mm)

Inserts sold in multiples of 1 | Screws sold in multiples of 10

**NOTICE:** Structural Steel GEN3SYS holders are specifically designed to be used only with XTST geometry inserts. Using other GEN3SYS XT or XT Pro insert geometries in these holders could lead to chip packing and tool failure. Contact Application Engineering for questions regarding proper use of tools.

## GEN3SYS® XT Pro Structural Steel Drilling System

26 Series | Diameter Range: 1.0236" - 1.1416" (26.00mm - 28.99mm)

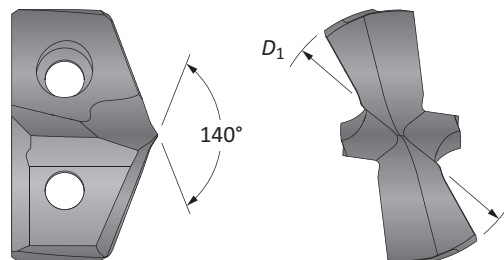
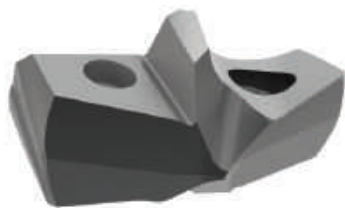

### Inserts

Fractional Equivalent	Insert $D_1$ inch	$D_1$ mm	 XTST Part No.
-	1.0236	26.00	XTST26-26.00
1-1/16	1.0625	26.99	XTST26-26.99
-	1.0630	27.00	XTST26-27.00
-	1.1024	28.00	XTST26-28.00
1-1/8	1.1250	28.58	XTST26-28.58

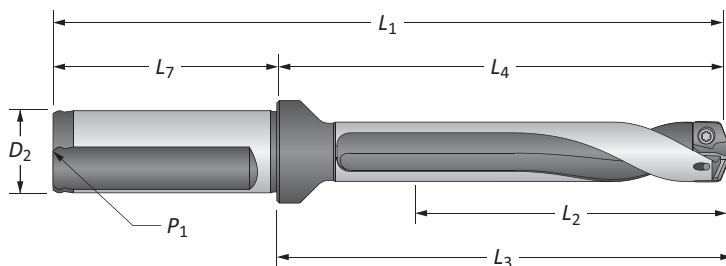





### Holders

Length	Body				Shank				Part No.
	$L_2$	$L_4$	$L_3$	$L_1$	$L_7$	$D_2$	$P_1$	Flat	
<b>i</b> 3xD	3-27/64	5-1/16	5-3/16	7-11/32	2-9/32	1-1/4	1/4	YES	ST03260-125F
<b>i</b> 5xD	5-23/32	7-11/32	7-31/64	9-5/8	2-9/32	1-1/4	1/4	YES	ST05260-125F
<b>i</b> 7xD	7-63/64	9-5/8	9-49/64	11-29/32	2-9/32	1-1/4	1/4	YES	ST07260-125F
<b>m</b> 3xD	87.0	128.1	131.4	188.1	60	32	1/4*	YES	ST03260-32FM
<b>m</b> 5xD	145.0	186.1	189.4	246.1	60	32	1/4*	YES	ST05260-32FM
<b>m</b> 7xD	202.9	244.0	247.4	304.0	60	32	1/4*	YES	ST07260-32FM

\*Thread to BSP and ISO 7-1

### Connection Accessories

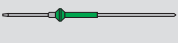
 Insert Screws	 Nylon Locking Screws	 Insert Driver	 Preset Torque Hand Driver	 Replacement Tips	Admissible Tightening Torque*
7495-IP15-1	7495N-IP15-1	8IP-15	8IP-15TL	8IP-15B	61.0 in-lbs (690 N-cm)

\*Tightening torques are calculated with a friction coefficient of  $\mu = 0.14$  and develop 90% of ultimate yield strength

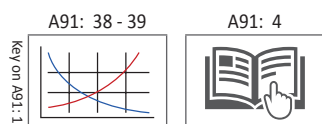

**i** = Imperial (in)  
**m** = Metric (mm)

Inserts sold in multiples of 1 | Screws sold in multiples of 10

**NOTICE:** Structural Steel GEN3SYS holders are specifically designed to be used only with XTST geometry inserts. Using other GEN3SYS XT or XT Pro insert geometries in these holders could lead to chip packing and tool failure. Contact Application Engineering for questions regarding proper use of tools.

## GEN3SYS® XT Pro Structural Steel Drilling System

29 Series | Diameter Range: 1.1417" - 1.2597" (29.00mm - 31.99mm)

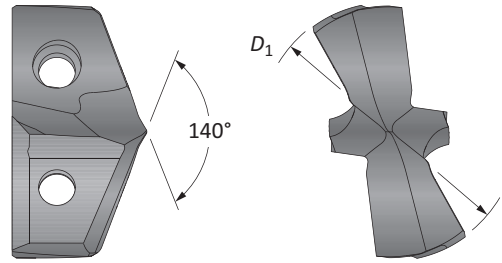
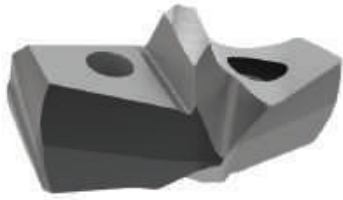

### Inserts

Fractional Equivalent	Insert $D_1$ inch	$D_1$ mm	 XTST Part No.
-	1.1417	29.00	XTST29-29.00
-	1.1811	30.00	XTST29-30.00
1-3/16	1.1875	30.16	XTST29-30.16
-	1.2205	31.00	XTST29-31.00
1-1/4	1.2500	31.75	XTST29-31.75

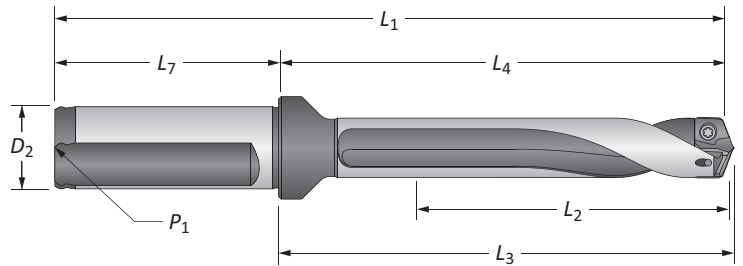





### Holders

	Length	Body				Shank				Part No.
		$L_2$	$L_4$	$L_3$	$L_1$	$L_7$	$D_2$	$P_1$	Flat	
<b>i</b>	3xD	3-25/32	5-3/8	5-33/64	7-21/32	2-9/32	1-1/4	1/4	YES	ST03290-125F
	5xD	6-19/64	7-29/32	8-3/64	10-3/16	2-9/32	1-1/4	1/4	YES	ST05290-125F
	7xD	8-13/16	10-27/64	10-9/16	12-45/64	2-9/32	1-1/4	1/4	YES	ST07290-125F
<b>m</b>	3xD	96.0	136.2	139.7	196.2	60	32	1/4*	YES	ST03290-32FM
	5xD	159.9	200.1	203.7	260.1	60	32	1/4*	YES	ST05290-32FM
	7xD	223.9	264.1	267.7	324.1	60	32	1/4*	YES	ST07290-32FM

\*Thread to BSP and ISO 7-1

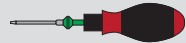
### Connection Accessories

 Insert Screws	 Nylon Locking Screws	 Insert Driver	 Preset Torque Hand Driver	 Replacement Tips	Admissible Tightening Torque*
7495-IP15-1	7495N-IP15-1	8IP-15	8IP-15TL	8IP-15B	61.0 in-lbs (690 N-cm)

\*Tightening torques are calculated with a friction coefficient of  $\mu = 0.14$  and develop 90% of ultimate yield strength

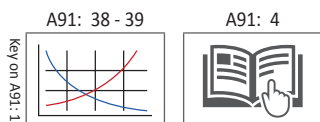

**i** = Imperial (in)  
**m** = Metric (mm)

Inserts sold in multiples of 1 | Screws sold in multiples of 10

**NOTICE:** Structural Steel GEN3SYS holders are specifically designed to be used only with XTST geometry inserts. Using other GEN3SYS XT or XT Pro insert geometries in these holders could lead to chip packing and tool failure. Contact Application Engineering for questions regarding proper use of tools.

## GEN3SYS® XT Pro Structural Steel Drilling System

32 Series | Diameter Range: 1.2598" - 1.3780" (32.00mm - 35.00mm)

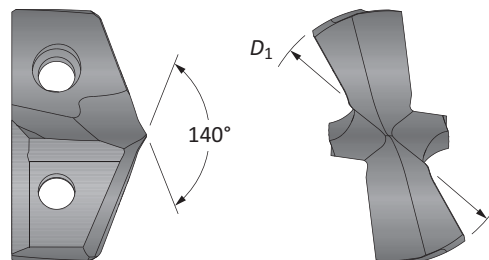
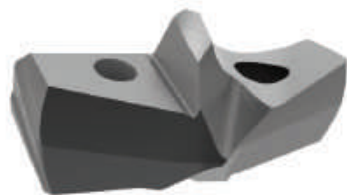

### Inserts

Fractional Equivalent	Insert $D_1$ inch	$D_1$ mm	 XTST Part No.
-	1.2598	32.00	XTST32-32.00
-	1.2992	33.00	XTST32-33.00
1-5/16	1.3125	33.34	XTST32-33.34
-	1.3386	34.00	XTST32-34.00
1-3/8	1.3750	34.93	XTST32-34.93

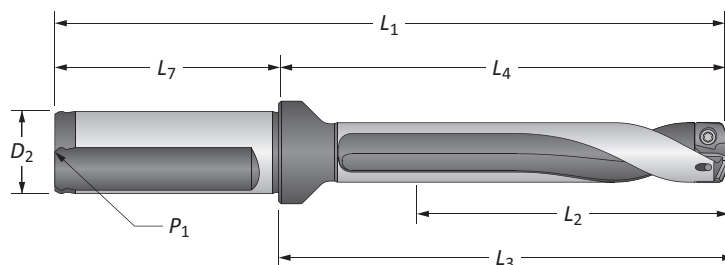





### Holders

Length	Body				Shank				Flat	Part No.
	$L_2$	$L_4$	$L_3$	$L_1$	$L_7$	$D_2$	$P_1$			
<b>i</b> 3xD	4-9/64	6-7/32	6-3/8	8-29/32	2-11/16	1-1/2	1/4	YES	ST03320-150F	
<b>i</b> 5xD	6-59/64	8-31/32	9-1/8	11-21/32	2-11/16	1-1/2	1/4	YES	ST05320-150F	
<b>i</b> 7xD	9-41/64	11-23/32	11-57/64	14-13/32	2-11/16	1-1/2	1/4	YES	ST07320-150F	
<b>m</b> 3xD	105.0	157.7	162.0	217.7	60	32	1/4*	YES	ST03320-32FM	
<b>m</b> 3xD	105.0	157.7	162.0	227.7	70	40	1/4*	YES	ST03320-40FM	
<b>m</b> 5xD	175.0	227.7	232.0	287.7	60	32	1/4*	YES	ST05320-32FM	
<b>m</b> 5xD	175.0	227.7	232.0	297.7	70	40	1/4*	YES	ST05320-40FM	
<b>m</b> 7xD	244.9	297.7	302.2	357.7	60	32	1/4*	YES	ST07320-32FM	
<b>m</b> 7xD	244.9	297.7	302.2	367.7	70	40	1/4*	YES	ST07320-40FM	

\*Thread to BSP and ISO 7-1

### Connection Accessories

 Insert Screws	 Nylon Locking Screws	 Insert Driver	 Preset Torque Hand Driver	 Replacement Tips	Admissible Tightening Torque*
7495-IP15-1	7495N-IP15-1	8IP-15	8IP-15TL	8IP-15B	61.0 in-lbs (690 N-cm)

\*Tightening torques are calculated with a friction coefficient of  $\mu = 0.14$  and develop 90% of ultimate yield strength

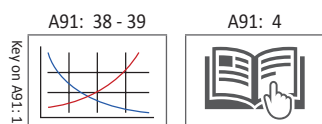

**i** = Imperial (in)  
**m** = Metric (mm)

Inserts sold in multiples of 1 | Screws sold in multiples of 10

**NOTICE:** Structural Steel GEN3SYS holders are specifically designed to be used only with XTST geometry inserts. Using other GEN3SYS XT or XT Pro insert geometries in these holders could lead to chip packing and tool failure. Contact Application Engineering for questions regarding proper use of tools.





T-A® Structural Steel Drilling System

STRUCTURAL STEEL  
**ENHANCEMENTS**

Original T-A & GEN2 T-A

**GEN2 T-A Insert**

*Available in AM200® Coating*



**High Efficiency (-HE)**

- Improves performance
- Improves tool life
- Improves chip formation in structural steel materials

**Original T-A Inserts**

*Available in AM200® and TiAlN Coatings*



**Thin Wall (-TW)**

- Designed for drilling 7/16" thick or less I-Beam or structural materials
- Increases hole diameter tolerance
- Improves hole roundness
- Decreases material deflection



**Notch Point® (-NP)**

- Provides excellent self-centering characteristics
- Reduces bell mouth and tool lead-off
- Reduces axial thrust requirements



**Structural Steel (-SS)**

- Designed for drilling 7/16" thick or thicker I-Beam or structural materials
- Reduces exit burrs
- Increases stability
- Lowers drilling forces
- Includes Notch Point® web geometry



**Holder Anatomy**

1. Morse Taper Shank
2. Coolant Inlet
3. Flute (straight or helical)
4. Built-up Body Diameter
5. Coolant Outlets



Straight Flute



Helical Flute

## T-A® Drill Nomenclature

### T-A Drill Inserts

<b>4</b>	<b>5</b>	<b>3</b>	<b>H</b>	-	<b>0115</b>	-	<b>HE</b>
1	2	3	4		5		6

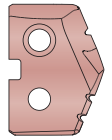

1. Insert	2. Material	3. Series	4. Coating	5. Diameter	6. Geometry
1 = Original T-A 4 = GEN2 T-A	5 = Super cobalt C1 = C1 (K35) carbide	0 = 0 series 1 = 1 series 2 = 2 series 3 = 3 series	H = AM200® A = TiAlN	0017 = Inch .515 = Decimal 13 = Metric	TW = Thin Wall NP = Notch Point® SS = Structural Steel HE = High Efficiency

#### Reference Key

Symbol	Attribute
$D_1$	Insert diameter
$T_1$	Insert thickness

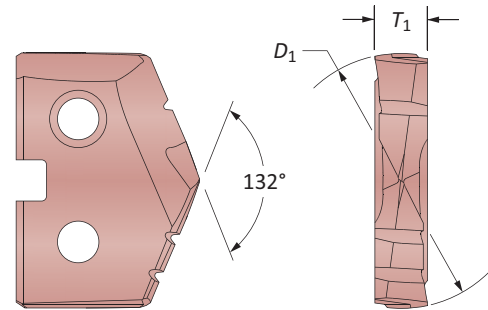

### T-A Drill Holders

<b>2</b>	<b>40</b>	<b>20</b>	<b>S</b>	-	<b>004</b>	<b>IS</b>	<b>060</b>
1	2	3	4		5	6	7



1. Holder	2. Length	3. Series	4. Flute
2 = T-A holder	20 = Short 40 = Standard 50 = Extended 60 = Long	00 = 0 series 05 = 0.5 series 10 = 1 series 15 = 1.5 series 20 = 2 series 25 = 2.5 series 30 = 3 series	S = Straight H = Helical
5. Shank Designator	6. Shank Code	7. Minimum Insert Diameter	
003 = 3MT 004 = 4MT	IS = Imperial Morse taper structural steel	In increments of 1/64 of an inch	

#### Reference Key

Symbol	Attribute	Symbol	Attribute
$D_1$	Drill insert range	$L_4$	Flute length
$L_1$	Overall length	$P_1$	Rear pipe tap
$L_2$	Drill depth	$P_2$	Side pipe tap
$L_3$	Holder reference length	MT	Morse taper size
$L_3^*$	Holder reference length		

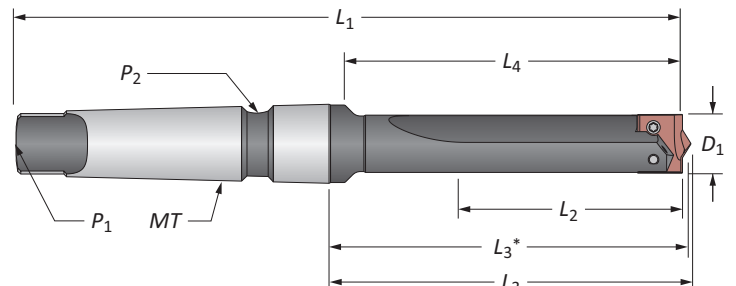

\*If using Structural Steel holder with Notch Point®, GEN2 T-A, or 150° Structural Steel T-A drill insert geometry

## Original T-A® Structural Steel Drill Inserts

0 Series | Diameter Range: 0.5512" - 0.6875" (14.00mm - 17.46mm)

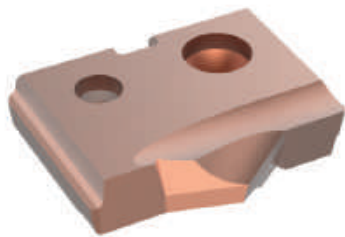

**Thin Wall**  
For material up to 7/16" thick

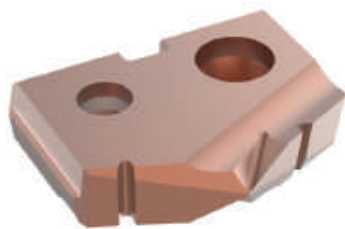
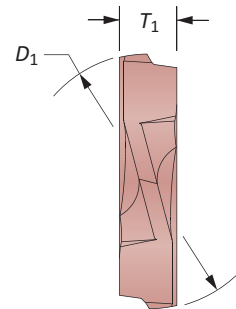
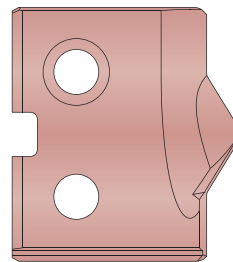

**Notch Point®**  
For material over 7/16" thick

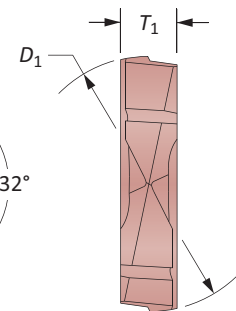
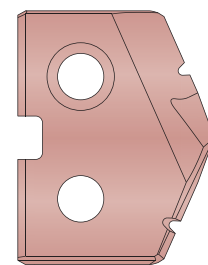

**150° Structural Steel**  
For material over 7/16" thick  
and for reduced exit burr

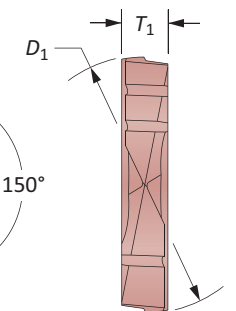
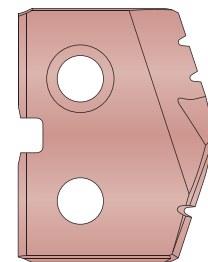

### HSS Inserts – Super Cobalt

Series	Insert					Thin Wall		Notch Point		150° Structural Steel	
	Fractional Equivalent	$D_1$ inch	$D_1$ mm	$T_1$							
					AM200 Part No.	TiAlN Part No.	AM200 Part No.	TiAlN Part No.	AM200 Part No.	TiAlN Part No.	
0	–	0.5512	14.00	1/8	150H-14-TW	150A-14-TW	150H-14-NP	150A-14-NP	150H-14-SS	150A-14-SS	
	9/16	0.5625	14.29	1/8	150H-0018-TW	150A-0018-TW	150H-0018-NP	150A-0018-NP	150H-0018-SS	150A-0018-SS	
	5/8	0.6250	15.88	1/8	150H-0020-TW	150A-0020-TW	150H-0020-NP	150A-0020-NP	150H-0020-SS	150A-0020-SS	
0.5	–	0.6299	16.00	1/8	150H-16-TW	150A-16-TW	150H-16-NP	150A-16-NP	150H-16-SS	150A-16-SS	
	11/16	0.6875	17.46	1/8	150H-0022-TW	150A-0022-TW	150H-0022-NP	150A-0022-NP	150H-0022-SS	150A-0022-SS	

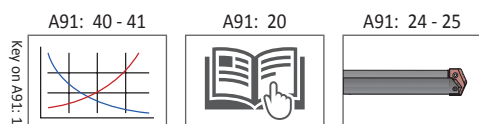

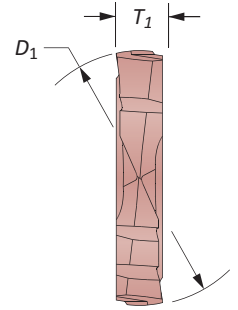
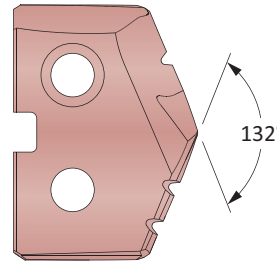

## GEN2 T-A® Structural Steel Drill Inserts

0 Series | Diameter Range: 0.5512" - 0.6875" (14.00mm - 17.46mm)



HSS Inserts – Super Cobalt | Carbide Inserts – C1 (K35)

Series	Fractional Equivalent	Insert			Part No.	
		$D_1$ inch	$D_1$ mm	$T_1$	 Super Cobalt	 C1 (K35)
0	–	0.5512	14.00	1/8	<b>450H-14-HE</b>	<b>4C10H-14-HE</b>
	9/16	0.5625	14.29	1/8	<b>450H-0018-HE</b>	<b>4C10H-0018-HE</b>
0.5	5/8	0.6250	15.88	1/8	<b>450H-0020-HE</b>	<b>4C10H-0020-HE</b>
	–	0.6299	16.00	1/8	<b>450H-16-HE</b>	<b>4C10H-16-HE</b>
	11/16	0.6875	17.46	1/8	<b>450H-0022-HE</b>	<b>4C10H-0022-HE</b>

Key on A91-1

A91: 40 - 41

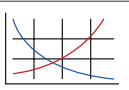

A91: 20



A91: 24 - 25



Inserts sold in multiples of 2

## T-A® Structural Steel Drill Insert Holders

0 Series | Taper Shank

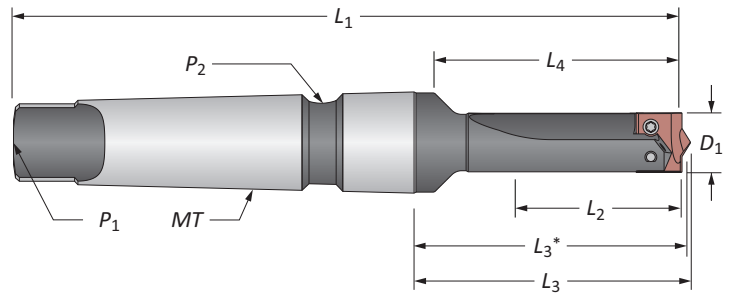

## Straight Flute #3 Morse Taper

Series	Length	$D_1$	Body					Shank			Part No.	
			$L_2$	$L_4$	$L_3$	$L_3^*$	$L_1$	MT	$P_1$	$P_2$		
i	0	Short	9/16	1-3/8	2-3/16	2-35/64	2-31/64	6-1/16	#3	TTC	TSC	22000S-003IS036
	0.5	Short	5/8	1-3/8	2-3/16	2-35/64	2-31/64	6-1/16	#3	TTC	TSC	22005S-003IS040
		Short	11/16	1-3/8	2-3/16	2-35/64	2-31/64	6-1/16	#3	TTC	TSC	22005S-003IS044
m	0	Short	14	35	56	64.7	63.1	154	#3	TTC	TSC	22000S-003IS036
		Short	16	35	56	64.7	63.1	154	#3	TTC	TSC	22000S-003IS040
		Short	17.5	35	56	64.7	63.1	154	#3	TTC	TSC	22000S-003IS044

\*If using Structural Steel holder with Notch Point®, GEN2 T-A, or 150° Structural Steel T-A drill insert geometry

## Connection Accessories

Series	Insert Screws	Nylon Locking Screws	Insert Driver	Preset Torque Hand Driver	Replacement Tips	Admissible Tightening Torque*
0	72556-IP8-1	72556N-IP8-1	8IP-8	8IP-8TL	8IP-8B	15.5 in-lbs (175 N-cm)
0.5	72567-IP8-1	72567N-IP8-1	8IP-8	8IP-8TL	8IP-8B	15.5 in-lbs (175 N-cm)

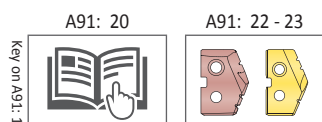
\*Tightening torques are calculated with a friction coefficient of  $\mu = 0.14$  and develop 90% of ultimate yield strength

i = Imperial (in)  
m = Metric (mm)

Screws sold in multiples of 10



## T-A® Structural Steel Drill Insert Holders

O Series | Taper Shank

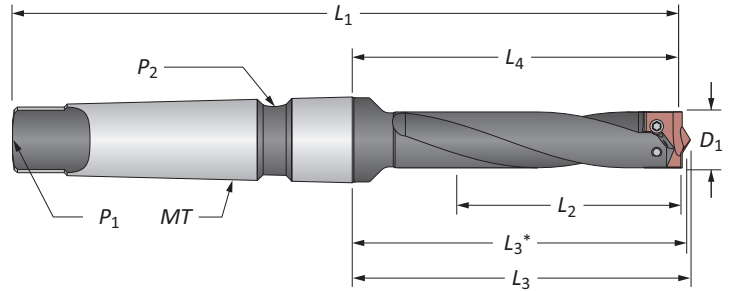

### Helical Flute #3 Morse Taper

Series	Length	D <sub>1</sub>	Body					Shank			Part No.	
			L <sub>2</sub>	L <sub>4</sub>	L <sub>3</sub>	L <sub>3</sub> *	L <sub>1</sub>	MT	P <sub>1</sub>	P <sub>2</sub>		
i	0	Standard	9/16	2-1/2	3-5/16	3-43/64	3-39/64	7-3/16	#3	TTC	TSC	24000H-003IS036
		Extended	9/16	6-1/2	9-7/16	9-51/64	9-19/32	13-5/64	#3	TTC	TSC	⚠ 25000H-003IS036
	0.5	Standard	5/8	2-1/2	3-5/16	3-43/64	3-39/64	7-3/16	#3	TTC	TSC	24005H-003IS040
		Extended	11/16	6-1/2	9-7/16	9-51/64	9-19/32	13-5/64	#3	TTC	TSC	⚠ 25005H-003IS044
m	0	Standard	14	64	84	93.3	91.7	183	#3	TTC	TSC	24000H-003IS036
		Extended	14	165	240	248.8	243.7	338	#3	TTC	TSC	⚠ 25000H-003IS036
	0.5	Standard	16	64	84	93.3	91.7	183	#3	TTC	TSC	24005H-003IS040
		Extended	17.5	64	84	93.3	91.7	183	#3	TTC	TSC	24005H-003IS044
			17.5	165	240	248.8	243.7	338	#3	TTC	TSC	⚠ 25005H-003IS044

\*If using Structural Steel holder with Notch Point®, GEN2 T-A, or 150° Structural Steel T-A drill insert geometry

i = Imperial (in)  
m = Metric (mm)

Screws sold in multiples of 10

**⚠ WARNING** Refer to Speed and Feed charts for recommended adjustments to speeds and feeds. Refer to page A91: 35 for deep hole drilling guidelines in this section of the catalog. Visit [www.alliedmachine.com/DeepHoleGuidelines](http://www.alliedmachine.com/DeepHoleGuidelines) for the most up-to-date information and procedures. Factory technical assistance is available for your specific applications through our Application Engineering Team.



## Original T-A® Structural Steel Drill Inserts

1 Series | Diameter Range: 0.7087" - 0.9449" (18.00mm - 24.00mm)



**Thin Wall**  
For material up to 7/16" thick

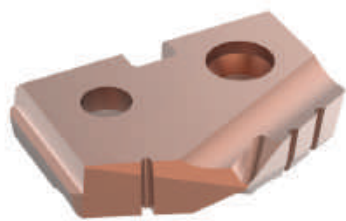
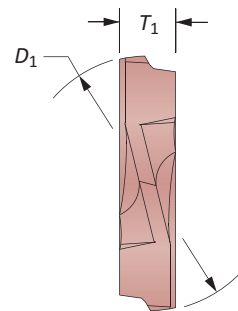
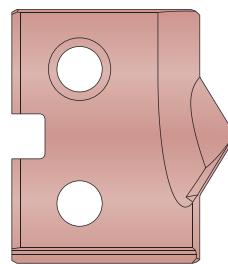

**Notch Point®**  
For material over 7/16" thick

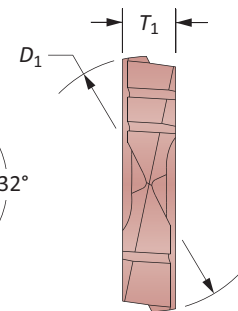
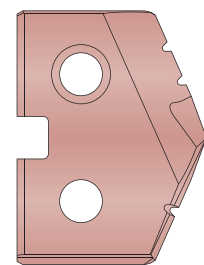

**150° Structural Steel**  
For material over 7/16" thick  
and for reduced exit burr

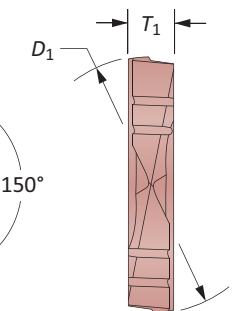
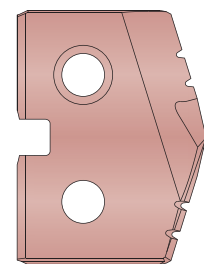

### HSS Inserts – Super Cobalt

Series	Insert				Thin Wall		Notch Point		150° Structural Steel	
	Fractional Equivalent	$D_1$ inch	$D_1$ mm	$T_1$	AM200 Part No.	TiAlN Part No.	AM200 Part No.	TiAlN Part No.	AM200 Part No.	TiAlN Part No.
1	–	0.7087	18.00	5/32						
	13/16	0.8125	20.64	5/32						
	–	0.8268	21.00	5/32						
	–	0.8661	22.00	5/32						
1.5	7/8	0.8750	22.23	5/32						
	15/16	0.9375	23.81	5/32						
	–	0.9449	24.00	5/32						

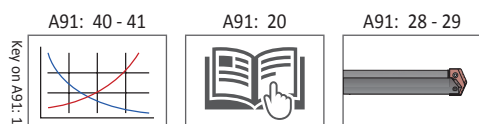

Inserts sold in multiples of 2



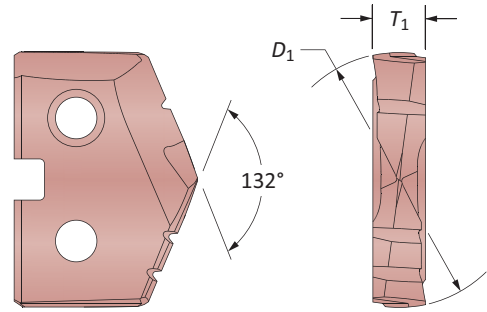

## GEN2 T-A® Structural Steel Drill Inserts

1 Series | Diameter Range: 0.7087" - 0.9449" (18.00mm - 24.00mm)



HSS Inserts – Super Cobalt | Carbide Inserts – C1 (K35)

Series	Fractional Equivalent	Insert			Part No.	
		$D_1$ inch	$D_1$ mm	$T_1$	 Super Cobalt	 C1 (K35)
1	–	0.7087	18.00	5/32	451H-18-HE	4C11H-18-HE
	13/16	0.8125	20.64	5/32	451H-0026-HE	4C11H-0026-HE
	–	0.8268	21.00	5/32	451H-21-HE	4C11H-21-HE
	–	0.8661	22.00	5/32	451H-22-HE	4C11H-22-HE
1.5	7/8	0.8750	22.23	5/32	451H-0028-HE	4C11H-0028-HE
	15/16	0.9375	23.81	5/32	451H-0030-HE	4C11H-0030-HE
	–	0.9449	24.00	5/32	451H-24-HE	4C11H-24-HE

Key on A91-1

A91: 40 - 41

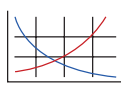

A91: 20



A91: 28 - 29



Inserts sold in multiples of 2

## T-A® Structural Steel Drill Insert Holders

1 Series | Taper Shank

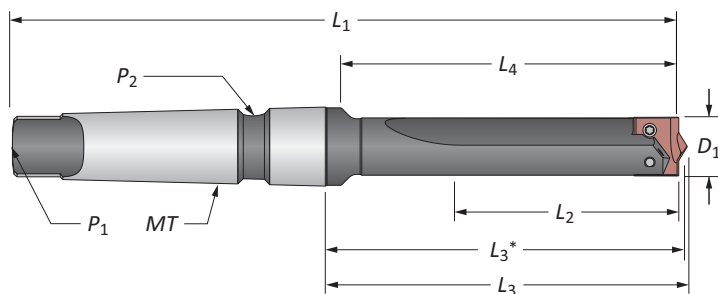

### Straight Flute #3 Morse Taper

Series	Length	$D_1$	Body					$L_1$	MT	$P_1$	$P_2$	Part No.
			$L_2$	$L_4$	$L_3$	$L_3^*$						
i	1	Short	18mm	2-3/4	3-7/8	4-17/64	4-13/64	7-3/4	#3	TTC	TSC	22010S-003IS045
		Short	13/16	2-3/4	3-7/8	4-17/64	4-13/64	7-3/4	#3	TTC	TSC	22010S-003IS052
	1.5	Short	7/8	2-3/4	3-7/8	4-17/64	4-13/64	7-3/4	#3	TTC	TSC	22015S-003IS056
		Short	15/16	2-3/4	3-7/8	4-17/64	4-13/64	7-3/4	#3	TTC	TSC	22015S-003IS060
m	1	Short	18	70	98	108.4	106.8	197	#3	TTC	TSC	22010S-003IS045
		Short	21	70	98	108.4	106.8	197	#3	TTC	TSC	22010S-003IS052
	1.5	Short	22	70	98	108.4	106.8	197	#3	TTC	TSC	22015S-003IS056
		Short	24	70	98	108.4	106.8	197	#3	TTC	TSC	22015S-003IS060





\*If using Structural Steel holder with Notch Point®, GEN2 T-A, or 150° Structural Steel T-A drill insert geometry

### Straight Flute #4 Morse Taper

Series	Length	$D_1$	Body					$L_1$	MT	$P_1$	$P_2$	Part No.
			$L_2$	$L_4$	$L_3$	$L_3^*$						
i	1	Short	18mm	2-3/4	3-7/8	4-21/64	4-17/64	8-3/4	#4	TTC	TSC	22010S-004IS045
		Short	13/16	2-3/4	3-7/8	4-21/64	4-17/64	8-3/4	#4	TTC	TSC	22010S-004IS052
	1.5	Short	7/8	2-3/4	3-7/8	4-21/64	4-17/64	8-3/4	#4	TTC	TSC	22015S-004IS056
		Short	15/16	2-3/4	3-7/8	4-21/64	4-17/64	8-3/4	#4	TTC	TSC	22015S-004IS060
m	1	Short	18	70	98	109.9	108.3	222	#4	TTC	TSC	22010S-004IS045
		Short	21	70	98	109.9	108.3	222	#4	TTC	TSC	22010S-004IS052
	1.5	Short	22	70	98	109.9	108.3	222	#4	TTC	TSC	22015S-004IS056
		Short	24	70	98	109.9	108.3	222	#4	TTC	TSC	22015S-004IS060

\*If using Structural Steel holder with Notch Point®, GEN2 T-A, or 150° Structural Steel T-A drill insert geometry

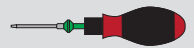
### Connection Accessories

Series	 Insert Screws	 Nylon Locking Screws	 Insert Driver	 Preset Torque Hand Driver	 Replacement Tips	Admissible Tightening Torque*
1	7375-IP9-1	7375N-IP9-1	8IP-9	8IP-9TL	8IP-9B	27.0 in-lbs (305 N-cm)
1.5	739-IP9-1	739N-IP9-1	8IP-9	8IP-9TL	8IP-9B	27.0 in-lbs (305 N-cm)

\*Tightening torques are calculated with a friction coefficient of  $\mu = 0.14$  and develop 90% of ultimate yield strength

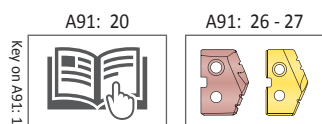

i = Imperial (in)  
m = Metric (mm)

Screws sold in multiples of 10



## T-A® Structural Steel Drill Insert Holders

1 Series | Taper Shank

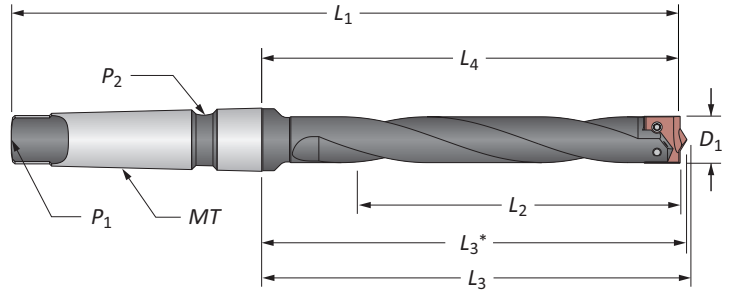

### Helical Flute #3 Morse Taper

Series	Length	D <sub>1</sub>	Body					Shank			Part No.	
			L <sub>2</sub>	L <sub>4</sub>	L <sub>3</sub>	L <sub>3</sub> *	L <sub>1</sub>	MT	P <sub>1</sub>	P <sub>2</sub>		
i	1	Standard	18mm	4-3/4	5-7/8	6-17/64	6-13/64	9-3/4	#3	TTC	TSC	24010H-003IS045
		Standard	13/16	4-3/4	5-7/8	6-17/64	6-13/64	9-3/4	#3	TTC	TSC	24010H-003IS052
		Extended	18mm	6-1/2	9-11/32	9-47/64	9-1/2	13-7/32	#3	TTC	TSC	⚠ 25010H-003IS045
	1.5	Standard	7/8	4-3/4	5-7/8	6-17/64	6-13/64	9-3/4	#3	TTC	TSC	24015H-003IS056
		Standard	15/16	4-3/4	5-7/8	6-17/64	6-13/64	9-3/4	#3	TTC	TSC	24015H-003IS060
		Extended	15/16	6-1/2	9-11/32	9-47/64	9-15/32	13-7/32	#3	TTC	TSC	⚠ 25015H-003IS060
m	1	Standard	18	121	149	159.2	157.6	248	#3	TTC	TSC	24010H-003IS045
		Standard	21	121	149	159.2	157.6	248	#3	TTC	TSC	24010H-003IS052
		Extended	18	165	237	247.3	241.3	336	#3	TTC	TSC	⚠ 25010H-003IS045
		Extended	22	165	237	247.3	241.3	336	#3	TTC	TSC	⚠ 25010H-003IS052
	1.5	Standard	22	121	149	159.2	157.6	248	#3	TTC	TSC	24015H-003IS056
		Standard	24	121	149	159.2	157.6	248	#3	TTC	TSC	24015H-003IS060
	Extended	24	165	237	247.3	234.5	336	#3	TTC	TSC	⚠ 25015H-003IS060	

\*If using Structural Steel holder with Notch Point®, GEN2 T-A, or 150° Structural Steel T-A drill insert geometry

### Helical Flute #4 Morse Taper

Series	Length	D <sub>1</sub>	Body					Shank			Part No.	
			L <sub>2</sub>	L <sub>4</sub>	L <sub>3</sub>	L <sub>3</sub> *	L <sub>1</sub>	MT	P <sub>1</sub>	P <sub>2</sub>		
i	1	Standard	18mm	4-3/4	5-7/8	6-21/64	6-17/64	10-3/4	#4	TTC	TSC	24010H-004IS045
		Standard	13/16	4-3/4	5-7/8	6-21/64	6-17/64	10-3/4	#4	TTC	TSC	24010H-004IS052
		Extended	13/16	6-1/2	9-9/32	9-47/64	9-43/64	14-5/32	#4	TTC	TSC	⚠ 25010H-004IS052
		Long	13/16	6-1/2	15-25/32	16-15/64	16-11/64	20-21/32	#4	TTC	TSC	⚠ 26010H-004IS052
	1.5	Standard	7/8	4-3/4	5-7/8	6-21/64	6-17/64	10-3/4	#4	TTC	TSC	24015H-004IS056
		Standard	15/16	4-3/4	5-7/8	6-21/64	6-17/64	10-3/4	#4	TTC	TSC	24015H-004IS060
	Extended	15/16	6-1/2	9-9/32	9-47/64	9-43/64	14-5/32	#4	TTC	TSC	⚠ 25015H-004IS060	
m	1	Standard	18	121	149	159.2	157.6	248	#4	TTC	TSC	24010H-004IS045
		Standard	21	121	149	159.2	157.6	248	#4	TTC	TSC	24010H-004IS052
		Extended	22	165	237	247.3	241.3	336	#4	TTC	TSC	⚠ 25010H-004IS052
		Long	22	165	237	247.3	241.3	336	#4	TTC	TSC	⚠ 26010H-004IS052
	1.5	Standard	22	121	149	159.2	157.6	248	#4	TTC	TSC	24015H-004IS056
		Standard	24	121	149	159.2	157.6	248	#4	TTC	TSC	24015H-004IS060
	Extended	24	165	237	247.3	234.5	336	#4	TTC	TSC	⚠ 25015H-004IS060	
	Long	24	165	237	247.3	234.5	336	#4	TTC	TSC	⚠ 26015H-004IS060	

\*If using Structural Steel holder with Notch Point®, GEN2 T-A, or 150° Structural Steel T-A drill insert geometry

i = Imperial (in)  
m = Metric (mm)

Screws sold in multiples of 10

**⚠ WARNING** Refer to Speed and Feed charts for recommended adjustments to speeds and feeds. Refer to page A91: 35 for deep hole drilling guidelines in this section of the catalog. Visit [www.alliedmachine.com/DeepHoleGuidelines](http://www.alliedmachine.com/DeepHoleGuidelines) for the most up-to-date information and procedures. Factory technical assistance is available for your specific applications through our Application Engineering Team.

A DRILLING  
B BORING  
C REAMING  
D BURNISHING  
E THREADING  
X SPECIALS

# Original T-A® Structural Steel Drill Inserts

2 Series | Diameter Range: 1.0000" - 1.3750" (25.40mm - 34.93mm)

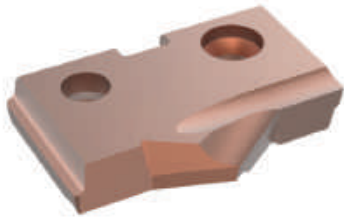

**Thin Wall**  
For material up to 7/16" thick

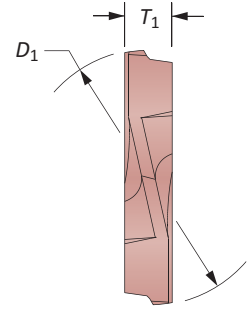
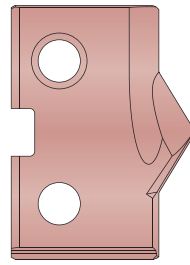

**Notch Point®**  
For material over 7/16" thick

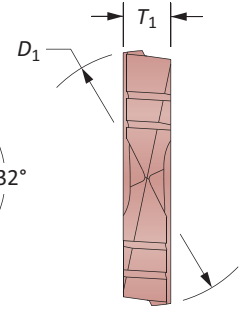
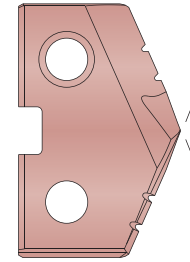

**150° Structural Steel**  
For material over 7/16" thick  
and for reduced exit burr

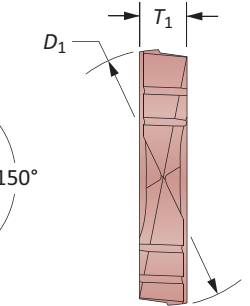
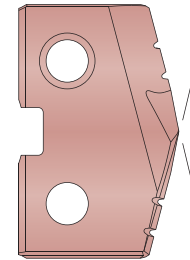

**HSS Inserts – Super Cobalt**

Series	Insert				Thin Wall		Notch Point		150° Structural Steel	
	Fractional Equivalent	D <sub>1</sub> inch	D <sub>1</sub> mm	T <sub>1</sub>	AM200 Part No.	TiAlN Part No.	AM200 Part No.	TiAlN Part No.	AM200 Part No.	TiAlN Part No.
2	1	1.0000	25.40	3/16	152H-0100-TW	152A-0100-TW	152H-0100-NP	152A-0100-NP	152H-0100-SS	152A-0100-SS
	–	1.0236	26.00	3/16	152H-26-TW	152A-26-TW	152H-26-NP	152A-26-NP	152H-26-SS	152A-26-SS
	1-1/16	1.0625	26.99	3/16	152H-0102-TW	152A-0102-TW	152H-0102-NP	152A-0102-NP	152H-0102-SS	152A-0102-SS
	–	1.0630	27.00	3/16	152H-27-TW	152A-27-TW	152H-27-NP	152A-27-NP	152H-27-SS	152A-27-SS
	1-1/8	1.1250	28.58	3/16	152H-0104-TW	152A-0104-TW	152H-0104-NP	152A-0104-NP	152H-0104-SS	152A-0104-SS
2.5	1-3/16	1.1875	30.16	3/16	152H-0106-TW	152A-0106-TW	152H-0106-NP	152A-0106-NP	152H-0106-SS	152A-0106-SS
	–	1.2205	31.00	3/16	152H-31-TW	152A-31-TW	152H-31-NP	152A-31-NP	152H-31-SS	152A-31-SS
	1-1/4	1.2500	31.75	3/16	152H-0108-TW	152A-0108-TW	152H-0108-NP	152A-0108-NP	152H-0108-SS	152A-0108-SS
	–	1.2992	33.00	3/16	152H-33-TW	152A-33-TW	152H-33-NP	152A-33-NP	152H-33-SS	152A-33-SS
	1-5/16	1.3125	33.34	3/16	152H-0110-TW	152A-0110-TW	152H-0110-NP	152A-0110-NP	152H-0110-SS	152A-0110-SS
	1-3/8	1.3750	34.93	3/16	152H-0112-TW	152A-0112-TW	152H-0112-NP	152A-0112-NP	152H-0112-SS	152A-0112-SS

A91: 40 - 41 A91: 20 A91: 32 - 33

Key on A91: 1

Inserts sold in multiples of 2

A DRILLING  
B BORING  
C REAMING  
D BURISHING  
E THREADING  
X SPECIALS



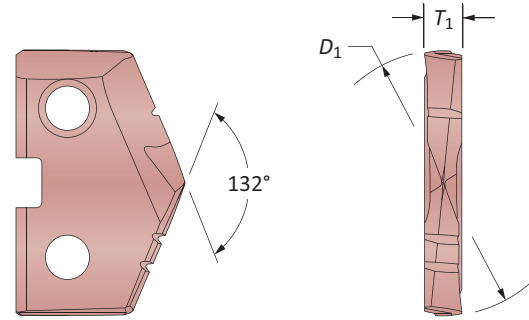

## GEN2 T-A® Structural Steel Drill Inserts

2 Series | Diameter Range: 1.0000" - 1.3750" (25.40mm - 34.93mm)



HSS Inserts – Super Cobalt | Carbide Inserts – C1 (K35)

Series	Fractional Equivalent	Insert			Part No.	
		D <sub>1</sub> inch	D <sub>1</sub> mm	T <sub>1</sub>	 Super Cobalt	 C1 (K35)
2	1	1.0000	25.40	3/16	452H-0100-HE	4C12H-0100-HE
	–	1.0236	26.00	3/16	452H-26-HE	4C12H-26-HE
	1-1/16	1.0625	26.99	3/16	452H-0102-HE	4C12H-0102-HE
	–	1.0630	27.00	3/16	452H-27-HE	4C12H-27-HE
	1-1/8	1.1250	28.58	3/16	452H-0104-HE	4C12H-0104-HE
2.5	1-3/16	1.1875	30.16	3/16	452H-0106-HE	4C12H-0106-HE
	–	1.2205	31.00	3/16	452H-31-HE	4C12H-31-HE
	1-1/4	1.2500	31.75	3/16	452H-0108-HE	4C12H-0108-HE
	–	1.2992	33.00	3/16	452H-33-HE	4C12H-33-HE
	1-5/16	1.3125	33.34	3/16	452H-0110-HE	4C12H-0110-HE
	1-3/8	1.3750	34.93	3/16	452H-0112-HE	4C12H-0112-HE

Key on A91-1

A91: 40 - 41

A91: 20

A91: 32 - 33

Inserts sold in multiples of 2

A DRILLING  
B BORING  
C REAMING  
D BURNISHING  
E THREADING  
X SPECIALS

## T-A® Structural Steel Drill Insert Holders

2 Series | Taper Shank

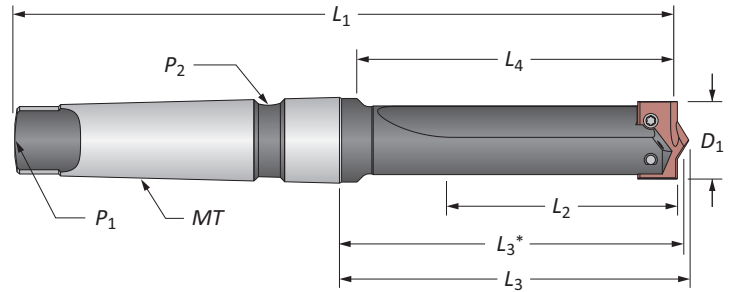

### Straight Flute #4 Morse Taper

Series	Length	D <sub>1</sub>	Body					Shank			Part No.	
			L <sub>2</sub>	L <sub>4</sub>	L <sub>3</sub>	L <sub>3</sub> *	L <sub>1</sub>	MT	P <sub>1</sub>	P <sub>2</sub>		
i	2	Short	1 - 1-3/8	3-3/8	4-1/2	4-63/64	4-57/64	9-3/8	#4	TTC	TSC	22020S-004IS100
	2.5	Short	1-3/16 - 1-3/8	3-3/8	4-1/2	4-63/64	4-57/64	9-3/8	#4	TTC	TSC	22025S-004IS112
m	2	Short	26	86	114	126.6	124.2	238	#4	TTC	TSC	22020S-004IS100
	2.5	Short	31	86	114	126.6	124.2	238	#4	TTC	TSC	22025S-004IS112

\*If using Structural Steel holder with Notch Point®, GEN2 T-A, or 150° Structural Steel T-A drill insert geometry

### Connection Accessories

Series	Insert Screws	Nylon Locking Screws	Insert Driver	Preset Torque Hand Driver	Replacement Tips	Admissible Tightening Torque*
2	7495-IP15-1	7495N-IP15-1	8IP-15	8IP-15TL	8IP-15B	61.0 in-lbs (690 N-cm)
2.5	7495-IP15-1	7495N-IP15-1	8IP-15	8IP-15TL	8IP-15B	61.0 in-lbs (690 N-cm)

\*Tightening torques are calculated with a friction coefficient of  $\mu = 0.14$  and develop 90% of ultimate yield strength

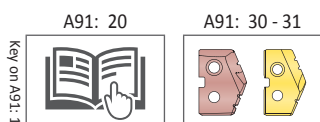

i = Imperial (in)  
m = Metric (mm)

Screws sold in multiples of 10



## T-A® Structural Steel Drill Insert Holders

2 Series | Taper Shank

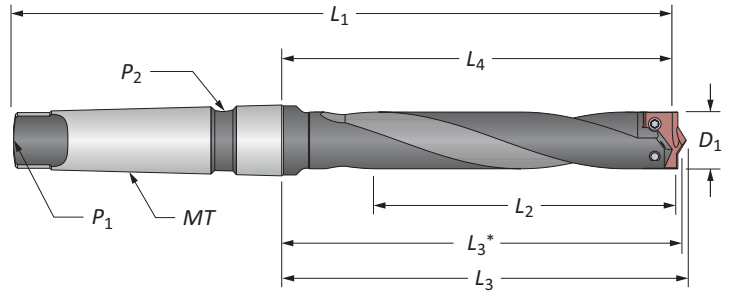

### Helical Flute #3 Morse Taper

Series	Length	D <sub>1</sub>	Body					Shank			Part No.
			L <sub>2</sub>	L <sub>4</sub>	L <sub>3</sub>	L <sub>3</sub> *	L <sub>1</sub>	MT	P <sub>1</sub>	P <sub>2</sub>	
<b>i</b> 2	Extended	1 - 1-3/8	6-1/2	9-11/32	9-3/4	9-29/64	13-7/32	#3	TTC	TSC	<b>⚠</b> 25020H-003IS100
<b>m</b> 2	Extended	26	165	237	247.7	240.1	336	#3	TTC	TSC	<b>⚠</b> 25020H-003IS100

\*If using Structural Steel holder with Notch Point®, GEN2 T-A, or 150° Structural Steel T-A drill insert geometry

### Helical Flute #4 Morse Taper

Series	Length	D <sub>1</sub>	Body					Shank			Part No.
			L <sub>2</sub>	L <sub>4</sub>	L <sub>3</sub>	L <sub>3</sub> *	L <sub>1</sub>	MT	P <sub>1</sub>	P <sub>2</sub>	
<b>i</b> 2	Standard	1 - 1-3/8	5-3/8	6-1/2	6-63/64	6-57/64	11-3/8	#4	TTC	TSC	24020H-004IS100
	Extended	1 - 1-3/8	6-1/2	9-7/32	9-3/4	9-43/64	14-5/32	#4	TTC	TSC	<b>⚠</b> 25020H-004IS100
	Long	1 - 1-3/8	6-1/2	16	16-15/32	16-25/64	20-7/8	#4	TTC	TSC	<b>⚠</b> 26020H-004IS100
<b>i</b> 2.5	Standard	1-3/16 - 1-3/8	5-3/8	6-1/2	6-63/64	6-57/64	11-3/8	#4	TTC	TSC	24025H-004IS112
<b>m</b> 2	Standard	26	137	165	177.4	175.0	289	#4	TTC	TSC	24020H-004IS100
	Extended	26	165	237	247.7	240.1	360	#4	TTC	TSC	<b>⚠</b> 25020H-004IS100
	Long	26	165	406	418.3	416.3	530	#4	TTC	TSC	<b>⚠</b> 26020H-004IS100
	Standard	31	137	165	177.4	175.0	289	#4	TTC	TSC	24025H-004IS112

\*If using Structural Steel holder with Notch Point®, GEN2 T-A, or 150° Structural Steel T-A drill insert geometry

**i** = Imperial (in)  
**m** = Metric (mm)

Screws sold in multiples of 10

**⚠ WARNING** Refer to Speed and Feed charts for recommended adjustments to speeds and feeds. Refer to page A91: 35 for deep hole drilling guidelines in this section of the catalog. Visit [www.alliedmachine.com/DeepHoleGuidelines](http://www.alliedmachine.com/DeepHoleGuidelines) for the most up-to-date information and procedures. Factory technical assistance is available for your specific applications through our Application Engineering Team.

A DRILLING  
 B BORING  
 C REAMING  
 D BURNISHING  
 E THREADING  
 X SPECIALS



## Original T-A® Structural Steel Drill Inserts

3 Series | Diameter Range: 1.4375" - 1.5625" (36.51mm - 39.69mm)



**Thin Wall**  
For material up to 7/16" thick

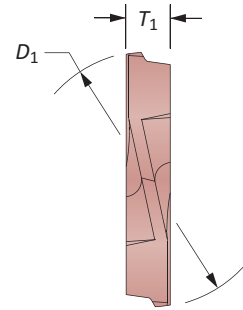
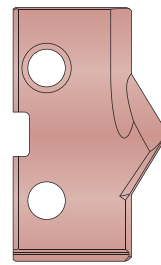



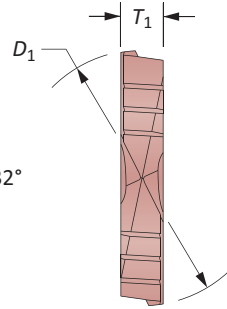
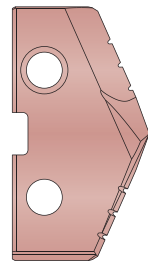

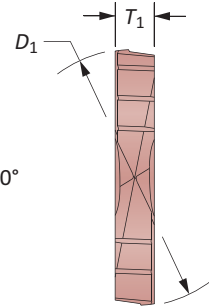
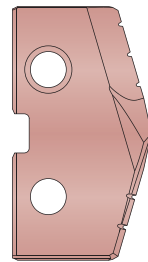

**Notch Point®**  
For material over 7/16" thick



**150° Structural Steel**  
For material over 7/16" thick  
and for reduced exit burr



### HSS Inserts – Super Cobalt

Insert				Thin Wall		Notch Point		150° Structural Steel	
Fractional Equivalent	$D_1$ inch	$D_1$ mm	$T_1$						
				AM200 Part No.	TiAlN Part No.	AM200 Part No.	TiAlN Part No.	AM200 Part No.	TiAlN Part No.
1-7/16	1.4375	36.51	1/4	153H-0114-TW	153A-0114-TW	153H-0114-NP	153A-0114-NP	153H-0114-SS	153A-0114-SS
1-1/2	1.5000	38.10	1/4	153H-0116-TW	153A-0116-TW	153H-0116-NP	153A-0116-NP	153H-0116-SS	153A-0116-SS
-	1.5354	39.00	1/4	153H-39-TW	153A-39-TW	153H-39-NP	153A-39-NP	153H-39-SS	153A-39-SS
1-9/16	1.5625	39.69	1/4	153H-0118-TW	153A-0118-TW	153H-0118-NP	153A-0118-NP	153H-0118-SS	153A-0118-SS

A91: 40 - 41

A91: 20

A91: 36 - 37

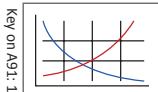

Inserts sold in multiples of 1





## GEN2 T-A® Structural Steel Drill Inserts

3 Series | Diameter Range: 1.4375" - 1.5625" (36.51mm - 39.69mm)

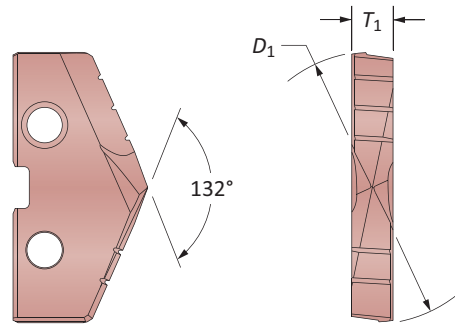

### HSS Inserts – Super Cobalt

Fractional Equivalent	Insert			Part No.
	$D_1$ inch	$D_1$ mm	$T_1$	Super Cobalt
1-7/16	1.4375	36.51	1/4	453H-0114-HE
1-1/2	1.5000	38.10	1/4	453H-0116-HE
-	1.5354	39.00	1/4	453H-39-HE
1-9/16	1.5625	39.69	1/4	453H-0118-HE

Key on A91-1

A91: 40 - 41

A91: 20

A91: 36 - 37

Inserts sold in multiples of 1

## T-A® Structural Steel Drill Insert Holders

3 Series | Taper Shank

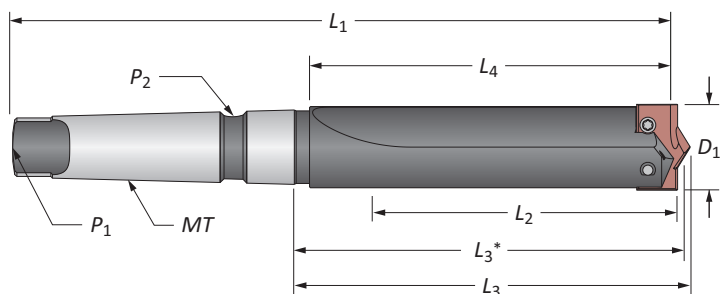

### Straight Flute #4 Morse Taper

Length	$D_1$	Body					Shank			Part No.
		$L_2$	$L_4$	$L_3$	$L_3^*$	$L_1$	MT	$P_1$	$P_2$	
① Short	1-13/32 - 1-7/8	4-3/4	6	6-1/2	6-7/16	10-7/8	#4	TTC	TSC	22030S-004IS126

\*If using Structural Steel holder with Notch Point®, GEN2 T-A, or 150° Structural Steel T-A drill insert geometry

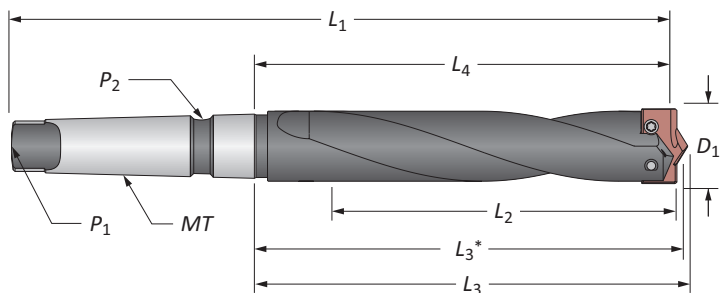

### Helical Flute #4 Morse Taper

Length	$D_1$	Body					Shank			Part No.
		$L_2$	$L_4$	$L_3$	$L_3^*$	$L_1$	MT	$P_1$	$P_2$	
① Standard	1-13/32 - 1-7/8	6-1/2	7-3/4	8-1/4	8-3/16	12-5/8	#4	TTC	TSC	24030H-004IS126

\*If using Structural Steel holder with Notch Point®, GEN2 T-A, or 150° Structural Steel T-A drill insert geometry

### Connection Accessories

Insert Screws	Nylon Locking Screws	Insert Driver	Preset Torque Hand Driver	Replacement Tips	Admissible Tightening Torque*
7514-IP20-1	7514N-IP20-1	8IP-20	-	-	121.3 in-lbs (1370 N-cm)

\*Tightening torques are calculated with a friction coefficient of  $\mu = 0.14$  and develop 90% of ultimate yield strength

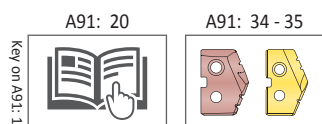





① = Imperial (in)  
 Ⓜ = Metric (mm)

Screws sold in multiples of 10

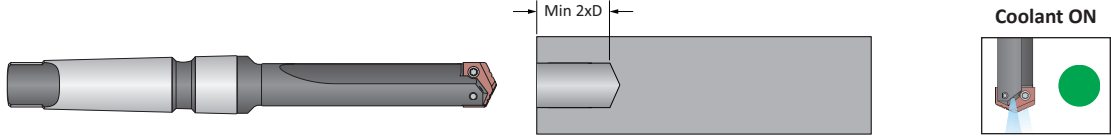
## Deep Hole Drilling Guidelines

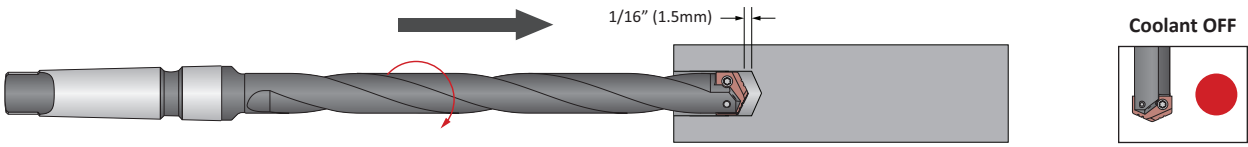
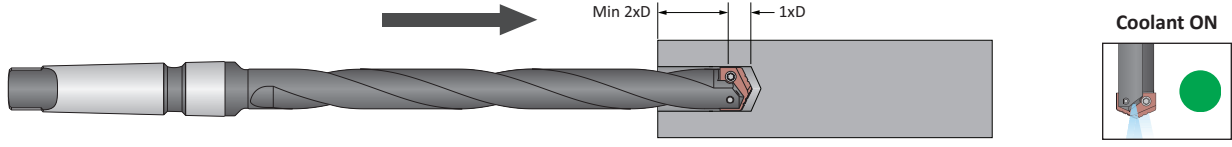
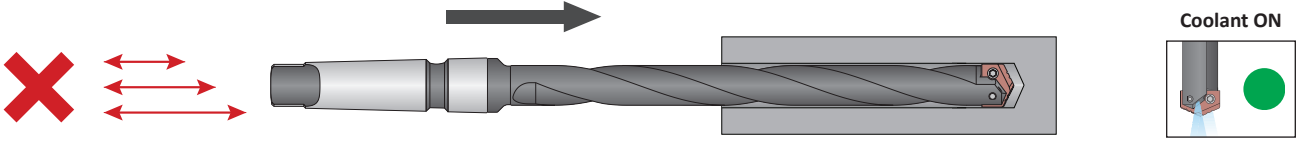
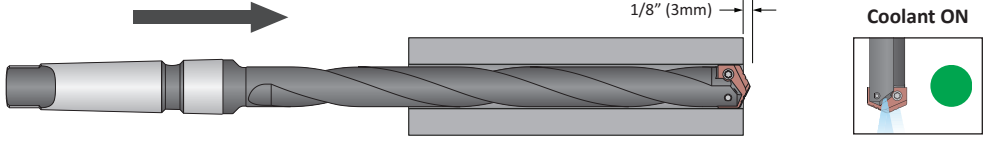
For Use with Drills Greater than 9xD (Extended, Long, XL, 3XL, and Special Length)

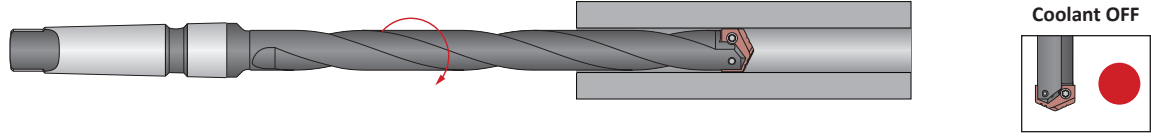
<p><b>1. Pilot Hole</b> 100 % RPM 100% IPR (mm/rev)</p>	<p>Establish the pilot hole using the same diameter short drill to a depth of 2xD minimum. Utilize a pilot drill with the same or larger included point angle.</p>	
<p> <b>2. Feed-in</b> 50 RPM max 12 IPM (300 mm/min)</p>	<p>Feed the longer drill within 1/16" (1.5mm) short of the established pilot hole bottom at a <b>maximum of 50 RPM</b> and 12 IPM (300 mm/min) feed rate.</p>	
<p><b>3. Deep Hole Transition Drilling</b> 50 % RPM 75% IPR (mm/rev)</p>	<p>Drill additional 1xD past the bottom of the pilot hole at 50% reduction of recommended speed and 25% reduction of recommended feed. Minimum of 1 second dwell is required to meet full speed before feeding.</p>	
<p><b>4. Deep Hole Drilling - Blind</b> 100% RPM 100% IPR (mm/rev)</p>	<p>Drill to full depth at recommended speed and feed for longer drill according to Allied speed and feed charts. <b>No peck cycle recommended.</b></p>	
<p><b>5. Deep Hole Drilling - at Breakout</b> 50% RPM 75% IPR (mm/rev)</p>	<p><b>For through holes only:</b> Reduce speed by 50% and feed by 25% prior to breakout. Do not break out more than 1/8" (3mm) past the full diameter of the drill.</p>	
<p> <b>6. Drill Retract</b> 50 RPM max</p>	<p>Reduce speed to a <b>maximum of 50 RPM</b> before retracting from the hole.</p>	

**⚠ WARNING** Tool failure can cause serious injury. To prevent:

- When using holders without support bushing, use a short T-A® holder to establish an initial hole that is a minimum of 2 diameters deep.
- Do not rotate tool holders more than 50 RPM unless it is engaged with the workpiece or fixture.

Visit [www.alliedmachine.com/DeepHoleGuidelines](http://www.alliedmachine.com/DeepHoleGuidelines) for the most up-to-date information and procedures. Factory technical assistance is available for your specific applications through our Application Engineering Team.

A  
DRILLING  
B  
BORING  
C  
REAMING  
D  
BURNISHING  
E  
THREADING  
X  
SPECIALS

## Recommended Cutting Data

GEN3SYS® XT Pro (XTST)

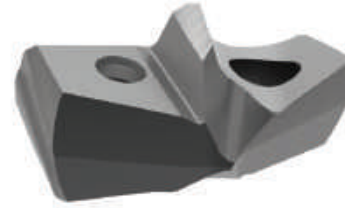

### Imperial (inch)

ISO	Material	Speed (SFM) - Mist Coolant		Feed Rate (IPR) by Diameter			
		Hardness (BHN)	 AM420 Speed	12 series 0.4724 - 0.5117	13 series 0.5118 - 0.5511	14 series 0.5512 - 0.5905	15 series 0.5906 - 0.6298
P	Structural Steel A36, A285, A516, A572, etc.	100 - 150	350	0.008	0.009	0.010	0.010
		150 - 250	300	0.007	0.008	0.009	0.009
		250 - 350	260	0.006	0.007	0.008	0.008

### Metric (mm)

ISO	Material	Speed (M/mm) - Mist Coolant		Feed Rate (mm/rev) by Diameter			
		Hardness (BHN)	 AM420 Speed	12 series 12.00 - 12.99	13 series 13.00 - 13.99	14 series 14.00 - 14.99	15 series 15.00 - 15.99
P	Structural Steel A36, A285, A516, A572, etc.	100 - 150	107	0.20	0.22	0.25	0.25
		150 - 250	91	0.18	0.20	0.23	0.23
		250 - 350	79	0.15	0.17	0.20	0.20

### Speed and Feed Multiplier

	Depth of Cut	
	<= 1.5xD	> 1.5xD
Speed	See above chart	0.75
Feed	See above chart	0.90

**NOTE:** The speeds and feeds listed above are based on a rigid setup using air mist through tool coolant. Speed may be increased up to 50% if using high pressure flood or through coolant.  
**NOTE:** If drilling dry without coolant, speed must be reduced significantly based on setup, drill depth, and material hardness. Up to 50% speed and feed reduction may be necessary in these types of applications. Contact the Application Engineering department for assistance.  
**NOTE:** If drilling material thickness of 0.500" (12.7mm) or less, a minimum of 10% reduction in feed is required to minimize material deflection.

**Feed Rate (IPR) by Diameter**

16 series 0.6299 - 0.6692	17 series 0.6693 - 0.7086	18 series 0.7087 - 0.7873	20 series 0.7874 - 0.8660	22 series 0.8661 - 0.9448	24 series 0.9449 - 1.0235	26 series 1.0236 - 1.1416	29 series 1.1417 - 1.2597	32 series 1.2598 - 1.3780
0.012	0.012	0.014	0.015	0.016	0.017	0.018	0.019	0.019
0.010	0.010	0.012	0.014	0.015	0.016	0.017	0.018	0.018
0.009	0.009	0.011	0.012	0.013	0.014	0.015	0.016	0.016

**Feed Rate (mm/rev) by Diameter**



16 series 16.00 - 16.99	17 series 17.00 - 17.99	18 series 18.00 - 19.99	20 series 20.00 - 21.99	22 series 22.00 - 23.99	24 series 24.00 - 25.99	26 series 26.00 - 28.99	29 series 29.00 - 31.99	32 series 32.00 - 35.00
0.30	0.30	0.36	0.38	0.41	0.43	0.46	0.48	0.48
0.25	0.25	0.30	0.36	0.38	0.41	0.43	0.46	0.46
0.23	0.23	0.28	0.30	0.33	0.36	0.38	0.41	0.41

## Recommended Cutting Data | Imperial (inch)

Original T-A® | GEN2 T-A®



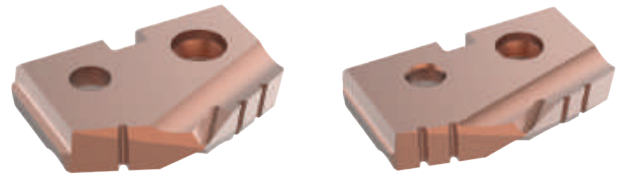

### Thin Wall Inserts Super Cobalt

ISO	Material	Speed (SFM) - Mist Coolant			Feed Rate (IPR) by Diameter			
		Hardness (BHN)	 AM200 Speed	 TiAlN Speed	0 series 9/16 - 11/16	1 series 13/16 - 15/16	2 series 1 - 1-3/8	3 series 1-13/32 - 1-7/8
P	Structural Steel A36, A285, A516, etc.	100 - 150	125	110	0.012	0.018	0.019	0.020
		150 - 250	115	100	0.011	0.016	0.017	0.019
		250 - 350	105	90	0.010	0.014	0.016	0.018



### Notch Point® and 150° Structural Steel Inserts Super Cobalt

ISO	Material	Speed (SFM) - Mist Coolant			Feed Rate (IPR) by Diameter			
		Hardness (BHN)	 AM200 Speed	 TiAlN Speed	0 series 9/16 - 11/16	1 series 13/16 - 15/16	2 series 1 - 1-3/8	3 series 1-13/32 - 1-7/8
P	Structural Steel A36, A285, A516, etc.	100 - 150	125	110	0.010	0.012	0.014	0.018
		150 - 250	115	100	0.009	0.011	0.012	0.016
		250 - 350	105	90	0.008	0.010	0.011	0.014



### GEN2 T-A Inserts Super Cobalt

ISO	Material	Speed (SFM) - Mist Coolant			Feed Rate (IPR) by Diameter			
		Hardness (BHN)	 AM200 Speed		0 series 9/16 - 11/16	1 series 13/16 - 15/16	2 series 1 - 1-3/8	3 series 1-13/32 - 1-7/8
P	Structural Steel A36, A285, A516, etc.	100 - 150	125		0.010	0.012	0.014	0.018
		150 - 250	115		0.009	0.011	0.012	0.016
		250 - 350	105		0.008	0.010	0.011	0.014

### GEN2 T-A Inserts Carbide C1 (K35)

ISO	Material	Speed (SFM) - Mist Coolant			Feed Rate (IPR) by Diameter			
		Hardness (BHN)	 AM200 Speed		0 series 9/16 - 11/16	1 series 13/16 - 15/16	2 series 1 - 1-3/8	3 series 1-13/32 - 1-7/8
P	Structural Steel A36, A285, A516, etc.	100 - 150	165		0.008	0.011	0.015	0.017
		150 - 250	155		0.006	0.010	0.013	0.015
		250 - 350	140		0.005	0.009	0.012	0.013



**NOTE:** The speeds and feeds listed above are based on a rigid setup using air mist through tool coolant. Speed may be increased up to 50% if using high pressure flood or through coolant.  
**NOTE:** If drilling dry without coolant, speed must be reduced significantly based on setup, drill depth, and material hardness. Up to 50% speed and feed reduction may be necessary in these types of applications. Contact the Application Engineering department for assistance.

## Recommended Cutting Data | Metric (mm)

Original T-A® | GEN2 T-A®



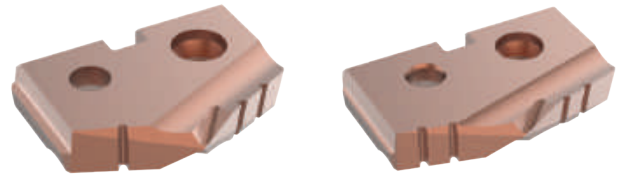

### Thin Wall Inserts Super Cobalt

ISO	Material	Speed (M/mm) - Mist Coolant			Feed Rate (mm/rev) by Diameter			
		Hardness (BHN)	 AM200 Speed	 TiAlN Speed	0 series 14 - 16	1 series 18 - 24	2 series 25 - 35	3 series 36 - 47
P	Structural Steel A36, A285, A516, etc.	100 - 150	39	34	0.30	0.45	0.48	0.50
		150 - 250	35	31	0.28	0.40	0.43	0.48
		250 - 350	32	28	0.25	0.36	0.40	0.45



### Notch Point® and 150° Structural Steel Inserts Super Cobalt

ISO	Material	Speed (M/mm) - Mist Coolant			Feed Rate (mm/rev) by Diameter			
		Hardness (BHN)	 AM200 Speed	 TiAlN Speed	0 series 14 - 16	1 series 18 - 24	2 series 25 - 35	3 series 36 - 47
P	Structural Steel A36, A285, A516, etc.	100 - 150	39	34	0.25	0.30	0.36	0.45
		150 - 250	35	31	0.23	0.28	0.30	0.40
		250 - 350	35	28	0.20	0.25	0.28	0.36



### GEN2 T-A Inserts Super Cobalt

ISO	Material	Speed (M/mm) - Mist Coolant		Feed Rate (mm/rev) by Diameter			
		Hardness (BHN)	 AM200 Speed	0 series 14 - 16	1 series 18 - 24	2 series 25 - 35	3 series 36 - 47
P	Structural Steel A36, A285, A516, etc.	100 - 150	39	0.25	0.30	0.36	0.46
		150 - 250	35	0.23	0.28	0.30	0.40
		250 - 350	35	0.20	0.25	0.28	0.36

### GEN2 T-A Inserts Carbide C1 (K35)

ISO	Material	Speed (M/mm) - Mist Coolant		Feed Rate (mm/rev) by Diameter			
		Hardness (BHN)	 AM200 Speed	0 series 14 - 16	1 series 18 - 24	2 series 25 - 35	3 series 36 - 47
P	Structural Steel A36, A285, A516, etc.	100 - 150	50	0.20	0.28	0.38	0.43
		150 - 250	47	0.15	0.25	0.33	0.38
		250 - 350	43	0.13	0.23	0.30	0.33

**NOTE:** The speeds and feeds listed above are based on a rigid setup using air mist through tool coolant. Speed may be increased up to 50% if using high pressure flood or through coolant.  
**NOTE:** If drilling dry without coolant, speed must be reduced significantly based on setup, drill depth, and material hardness. Up to 50% speed and feed reduction may be necessary in these types of applications. Contact the Application Engineering department for assistance.





SECTION

---

# A92

---

AccuPort 432®

# AccuPort 432®

Replaceable Insert Port Contour Cutters | J1926 | ISO6149 | AS5202 | JDG173.1



## High Performance Multi-Step Action

Durable and precise, the AccuPort 432 holders provide a strong and rigid platform for the drilling of hydraulic ports. The precision ground insert location on each holder ensures total repeatability and simple, uncomplicated changing of the replaceable inserts.

With the AccuPort technology, you can drill and finish port forms in **ONE** operation. Save time and money with AccuPort.

Single operation hydraulic port cutting system	No pre-drilling required	Replaceable inserts eliminate regrinding and resetting
--	--------------------------	--

## Applicable Industries



Aerospace



Agriculture



Automotive



Marine / Shipbuilding

Your safety and the safety of others is very important. This catalog contains important safety messages. Always read and follow all safety precautions.



This triangle is a safety hazard symbol. It alerts you to potential safety hazards that can cause tool failure and serious injury.

When you see this symbol in the catalog, look for a related safety message that may be near this triangle or referred to in the nearby text.

There are safety signal words also used in the catalog. Safety messages follow these words.

### **WARNING**

**WARNING** (shown above) means that failure to follow the precautions in this message could result in tool failure and serious injury.

**NOTICE** means that failure to follow the precautions in this message could result in damage to the tool or machine but not result in personal injury.

**NOTE** and **IMPORTANT** are also used. These are important that you read and follow but are not safety-related.

Visit [www.alliedmachine.com](http://www.alliedmachine.com) for the most up-to-date information and procedures.

**Reference Icons**

The following icons will appear throughout the catalog to help you navigate between products.



**Setup / Assembly Information**

Detailed instructions and information regarding the corresponding part(s)

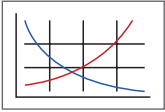

**Recommended Cutting Data**

Speed and feed recommendations for optimum and safe drilling

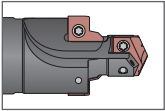

**Accuport 432 Holders**

Refers to the full details of the holder items included in each kit



**Port and Thread Finishing Kits**

Lists the available kits complete with AccuPort tool and AccuThread™ solid carbide thread mill

**Introduction Information**

Product Overview . . . . . 2 - 4  
 Product Nomenclature . . . . . 5

**Port Specifications**

SAE J-1926 / ISO 11926-1 / MS-16142 . . . . . 6 - 11  
 ISO 6149-1:2006 / SAE J-2244/1 . . . . . 12 - 13  
 SAE AS5202 / AND10050 . . . . . 14 - 15  
 JDS-G173.1 . . . . . 16 - 17

**Port and Thread Finishing Kits**

SAE J-1926 / ISO 11926-1 / MS-16142 . . . . . 18 - 21  
 ISO 6149-1:2006 / SAE J-2244/1 . . . . . 22 - 25  
 SAE AS5202 / AND10050 . . . . . 26 - 27  
 JDS-G173.1 . . . . . 28

**Recommended Cutting Data (Imperial)**

Imperial (inch)	[	HSS . . . . . 30 - 31
		Carbide . . . . . 32 - 33
Metric (mm)	[	HSS . . . . . 34 - 35
		Carbide . . . . . 36 - 37

**Product Overview**

A  
DRILLING  
B  
BORING  
C  
REAMING  
D  
BURNISHING  
E  
THREADING  
X  
SPECIALS

**ONE TOOL | FOUR OPERATIONS**

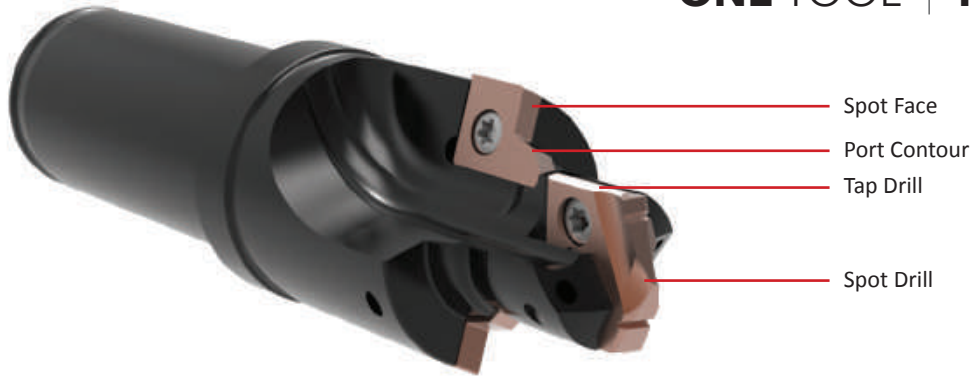









**Advanced Solutions, Outstanding Results**

As designers and manufacturing engineers push the limits of production technology to improve productivity and performance, Allied Machine has continued to innovate and develop new solutions like the unique AccuPort 432 hydraulic port contour cutter system. Every product in the AccuPort system is designed to deliver maximum performance in a diverse range of hydraulic port cutting applications and demanding manufacturing environments.

Using precision replaceable inserts for both the drilling and port forming operations, AccuPort eliminates the need for tool regrinding and enables absolute repeatability, excellent surface finish, and reduced cost-per-hole. The AccuPort drills, forms, and precision-finishes the hydraulic port in **one** pass. This replaces up to three separate cutting operations in a single tool to deliver outstanding improvements in productivity, accuracy, and repeatability.

Hydraulic systems are present in an incredibly diverse range of industries. Anywhere a hydraulic port is required, AccuPort can provide a more cost effective and higher performance solution in a fraction of the time taken for traditional methods using separate drills, special forming tools, and spot facers.

Port Specification	Notes
<p><b>Imperial</b> SAE J-1926 ISO 11926-1 MS-16142</p> 	<p>Extended minor diameter length option also available</p> 
<p><b>Metric</b> ISO 6149-1:2006 SAE J-2244/1</p> 	<p>Holders made with ID ridge Utilizes inserts with or without ID ridge</p>  ID ridge  No ID ridge 
<p><b>Military</b> SAE AS5202</p> 	<p>Also conforms to AND10050 specification by using an alternate tap drill size for a UN thread</p>
<p><b>John Deere</b> JDS-G173.1</p> 	<p>Adheres to John Deere port standards</p>



### Choosing the Right System

Every product in the AccuPort 432 product line is designed to deliver maximum performance in a diverse range of hydraulic port cutting applications and demanding manufacturing environments. The innovative design delivers the best possible range of benefits in terms of productivity, cost-per-hole, and tool life.

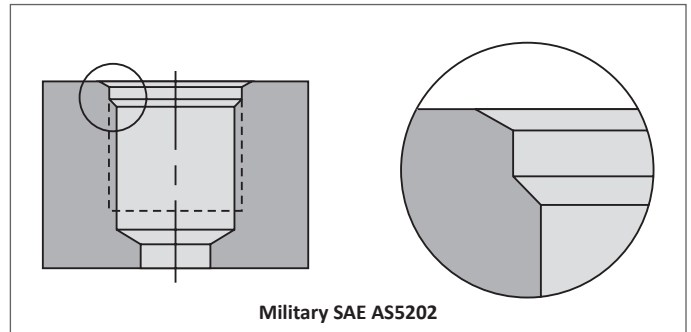
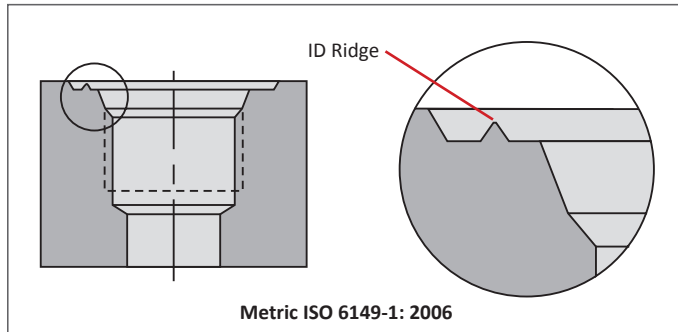
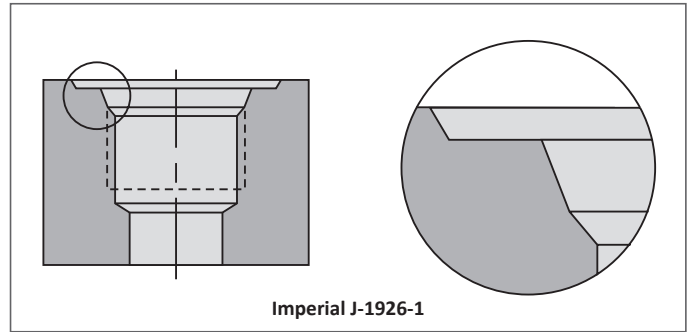

### Common Industry Sectors and Components



**Aerospace**  
Pumps  
Landing Gear  
Brake Cylinders  
Manifolds



**Agriculture**  
Pumps  
Manifolds  
Cylinders and Rams  
Gear Pumps



**Automotive**  
Motor Valves  
Relief Valves  
Brake Cylinders  
Power Steering Pumps



**Marine / Shipbuilding**  
Pumps  
Cylinders and Rams  
Motors  
Manifolds

### The Complete Package





Producing fully finished threaded hydraulic ports has never been easier. The Port and Thread Finishing Kit includes the AccuPort 432 contour cutter with a dedicated AccuThread™ solid carbide threadmill in a single kit. You also receive the T-A® inserts and port form inserts needed to complete the assembly.

Port kits incorporate the AccuThread solid carbide threadmills to increase the manufacturing flexibility by allowing hydraulic ports to be produced in just two operations. In addition, where a unique port profile is required, Allied Machine provides a dedicated special tooling solution using our extensive tool design and manufacturing experience to meet precise specifications.



## Replaceable Inserts Overview

T-A® Drill Insert Grades			
<b>HSS Super Cobalt</b> (Original T-A® / GEN2 T-A®)	<b>Carbide C5 (P40)</b> (Original T-A® only)	<b>Carbide C1 (K10)</b> (GEN2 T-A® only)	<b>Carbide C3 (K35)</b> (Original T-A® only)
Suited for good to rigid machining applications, used for drilling exotic and high alloy materials, or general use when surface speed needs to be increased for use in material hardness up to 350 BHN 121kg.	Excellent for drilling free machining steel, low/medium carbon steels, alloy steels, high strength steels, tool steels, and hardened steels.	Excellent for drilling free machining steel, low/medium carbon steels, alloy steels, high strength steels, tool steels, and hardened steels.	Designed for drilling grey/white cast irons. The special geometry offers substantial increases in penetration rates and provides exceptional edge strength and tool life.

Port Form Inserts	GEN2 T-A Inserts		Original T-A Inserts
 AM200®      TiAlN	 AM300®	 AM200®	 TiN

### GEN2 T-A Standard Geometry

- Designed for rigid machining applications, primarily used for drilling exotic and high alloy materials
- Ideal for general use when the surface speed needs to be increased

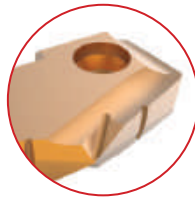

### Original T-A Standard Geometry

- First choice for machining aluminum
- Enhanced geometry improves chip formation and hole quality
- TiN coating improves heat resistance and extends tool life

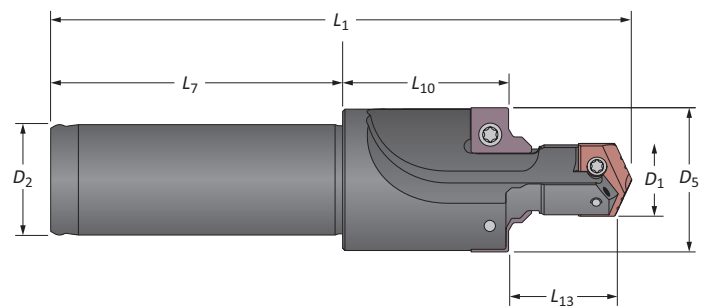
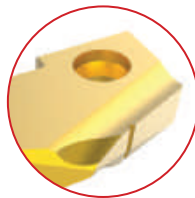

### Made-to-Order Tool Specifications

Scan and email a copy of the table below to Allied's Application Engineering Department to receive pricing for a made-to-order AccuPort 432 Port Contour Cutter.

Send emails to [appeng@alliedmachine.com](mailto:appeng@alliedmachine.com)

Tube Dash No.	Specification	Port Thread Size	D <sub>1</sub>	L <sub>13</sub>	D <sub>5</sub>	L <sub>10</sub>	L <sub>1</sub>	D <sub>2</sub>	L <sub>7</sub>
	<input type="checkbox"/> J1926 <input type="checkbox"/> ISO 6149 <input type="checkbox"/> ISO 6149 (no ridge) <input type="checkbox"/> JDS-G173.1 <input type="checkbox"/> AS5202								

<b>Company Name</b> <input type="text"/>	<b>Contact Name</b> <input type="text"/>	<b>Phone</b> <input type="text"/>
<b>Distributor Name</b> <input type="text"/>	<b>Fax</b> <input type="text"/>	

A  
DRILLING  
B  
BORING  
C  
REAMING  
D  
BURNISHING  
E  
THREADING  
X  
SPECIALS



## Product Nomenclature

### AccuPort 432 Holders

<b>J1926</b>	-	<b>04</b>	-	<b>Y</b>	-	<b>063F</b>
1		2		3		4

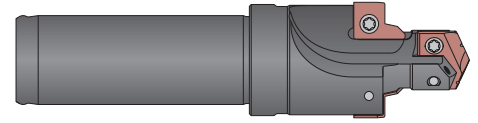

1. Port Specifications	2. Port Tube Dash No.	3. T-A® Insert Series	4. Shank Configuration	
<b>J1926</b> = Imperial - J1926-1 <b>X1926</b> = Imperial - J1926-1 (extended minor length) <b>I6149</b> = Metric (ISO) - 6149-1 <b>G1731</b> = John Deere - G173.1 <b>AS5202</b> = Military - AS5202	<b>04</b> <b>14</b> <b>05</b> <b>16</b> <b>06</b> <b>18</b> <b>08</b> <b>20</b> <b>10</b> <b>24</b> <b>12</b> <b>32</b>	<b>Y</b> = Y series <b>Z</b> = Z series <b>0</b> = 0 series <b>1</b> = 1 series <b>2</b> = 2 series <b>3</b> = 3 series <b>4</b> = 4 series	<b>Imperial</b> <b>063F</b> = 5/8" flanged <b>075F</b> = 3/4" flanged <b>100F</b> = 1" flanged <b>125F</b> = 1-1/4" flanged <b>150F</b> = 1-1/2" flanged	<b>Metric</b> <b>16FM</b> = 16mm flanged <b>20FM</b> = 20mm flanged <b>25FM</b> = 25mm flanged <b>32FM</b> = 32mm flanged

### AccuPort 432 Port Form Inserts

<b>J1926</b>	-	<b>02</b>	-	<b>R</b>	-	<b>C5</b>	-	<b>A</b>
1		2		3		4		5

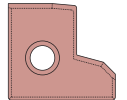

1. Port Specifications	2. Insert Size	3. Port Specifications	4. Substrate	5. Coating
<b>J1926</b> = Imperial <b>I6149</b> = Metric (ISO) <b>G1731</b> = John Deere <b>AS5202</b> = Military	<b>02</b> <b>10</b> <b>03</b> <b>11</b> <b>04</b> <b>12</b> <b>05</b> <b>14</b> <b>06</b> <b>16</b> <b>07</b> <b>20</b> <b>08</b> <b>24</b> <b>09</b> <b>32</b>	<b>Blank</b> = No ID ridge <b>R</b> = ID ridge	<b>C5</b> = C5 carbide <b>C3</b> = C3 carbide	<b>A</b> = TiAlN <b>H</b> = AM200®

### Reference Key

Symbol	Attribute
$A_1$	Seal angle
$D_1$	Minor diameter
$D_2$	Shank diameter
$D_3$	Pilot diameter
$D_4$	Seal angle diameter
$D_5$	Spot face diameter
$L_1$	Overall length
$L_7$	Shank length
$L_{10}$	Spot face to shoulder length
$L_{11}$	Total head length
$L_{12}$	Seal angle length
$L_{13}$	Minor diameter length
$P_1$	Rear pipe tap

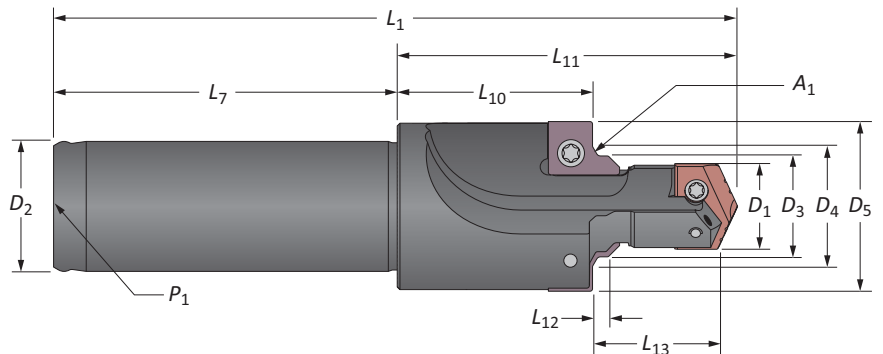

SAE J-1926 / ISO 11926-1 / MS-16142

Imperial Shank Holders

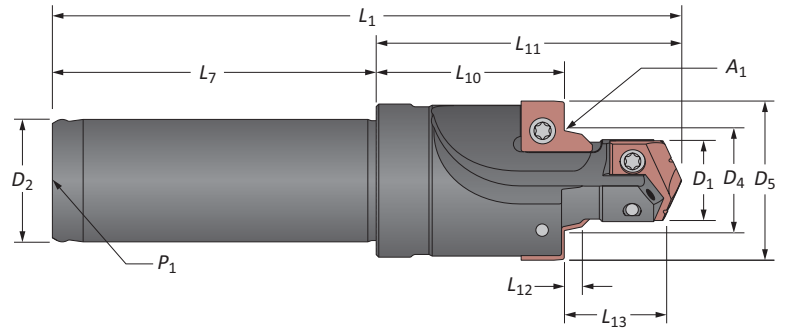

Tube Dash No.	Cutting			Seal Angle			Holder			Shank			Port Thread Size	Part No.
	D <sub>1</sub>	L <sub>13</sub> *	D <sub>5</sub>	A <sub>1</sub>	D <sub>4</sub>	L <sub>12</sub>	L <sub>11</sub>	L <sub>10</sub>	L <sub>1</sub>	L <sub>7</sub>	D <sub>2</sub>	P <sub>1</sub>		
-4	0.386	0.551	0.840	12°	0.490	0.106	1.527	0.896	3.402	1.875	0.625	1/16	7/16-20 UNF-2B	J1926-04Y-063F
-5	0.453	0.551	0.926	12°	0.553	0.106	1.527	0.885	3.402	1.875	0.625	1/16	1/2-20 UNF-2B	J1926-05Z-063F
-6	0.512	0.610	0.989	12°	0.618	0.106	1.857	1.144	3.826	1.969	0.750	1/8	9/16-18 UNF-2B	J1926-060-075F
-8	0.689	0.689	1.206	15°	0.813	0.106	1.982	1.150	3.951	1.969	0.750	1/8	3/4-16 UNF-2B	J1926-080-075F
-10	0.807	0.787	1.344	15°	0.945	0.106	2.140	1.185	4.421	2.281	1.000	1/8	7/8-14 UNF-2B	J1926-101-100F
<b>i</b> -12	0.984	0.906	1.655	15°	1.150	0.138	2.640	1.530	4.921	2.281	1.250	1/4	1 1/16-12 UN-2B	J1926-122-125F
-14	1.102	0.906	1.781	15°	1.276	0.138	2.640	1.504	4.921	2.281	1.250	1/4	1 3/16-12 UN-2B	J1926-142-125F
-16	1.231	0.906	1.934	15°	1.400	0.138	2.640	1.477	4.921	2.281	1.250	1/4	1 5/16-12 UN-2B	J1926-162-125F
-20	1.535	0.906	2.306	15°	1.715	0.138	3.062	1.835	5.750	2.688	1.500	1/4	1 5/8-12 UN-2B	J1926-203-150F
-24	1.791	0.906	2.564	15°	1.965	0.138	3.062	1.778	5.750	2.688	1.500	1/4	1 7/8-12 UN-2B	J1926-243-150F
-32	2.421	0.906	3.470	15°	2.589	0.138	3.812	2.393	6.500	2.688	1.500	1/4	2 1/2-12 UN-2B	J1926-324-150F
<b>m</b> -4	9.80	14.00	21.30	12°	12.50	2.70	38.80	22.80	86.40	47.60	15.90	1/16	7/16-20 UNF-2B	J1926-04Y-063F
-5	11.50	14.00	23.50	12°	14.10	2.70	38.80	22.50	86.40	47.60	15.90	1/16	1/2-20 UNF-2B	J1926-05Z-063F
-6	13.00	15.50	25.10	12°	15.70	2.70	47.20	29.00	97.20	50.00	19.10	1/8	9/16-18 UNF-2B	J1926-060-075F
-8	17.50	17.50	30.60	15°	20.70	2.70	50.30	29.20	100.40	50.00	19.10	1/8	3/4-16 UNF-2B	J1926-080-075F
-10	20.50	20.00	34.10	15°	24.00	2.70	54.40	30.10	112.30	57.90	25.40	1/8	7/8-14 UNF-2B	J1926-101-100F
<b>m</b> -12	25.00	23.00	42.00	15°	29.20	3.50	67.10	38.90	125.00	57.90	31.80	1/4	1 1/16-12 UN-2B	J1926-122-125F
-14	28.00	23.00	45.20	15°	32.40	3.50	67.10	38.20	125.00	57.90	31.80	1/4	1 3/16-12 UN-2B	J1926-142-125F
-16	31.20	23.00	49.10	15°	35.60	3.50	67.10	37.50	125.00	57.90	31.80	1/4	1 5/16-12 UN-2B	J1926-162-125F
-20	39.00	23.00	58.50	15°	43.60	3.50	77.80	46.60	146.00	68.30	38.10	1/4	1 5/8-12 UN-2B	J1926-203-150F
-24	45.50	23.00	65.10	15°	49.90	3.50	77.80	45.20	146.00	68.30	38.10	1/4	1 7/8-12 UN-2B	J1926-243-150F
-32	61.50	23.00	88.10	15°	65.80	3.50	96.80	60.80	165.10	68.30	38.10	1/4	2 1/2-12 UN-2B	J1926-324-150F

\*Port contour cutters are available with extended pilot length (L<sub>13</sub>). See pages A92: 10-11 for items.

A92: 30 - 37

A92: 2 - 4

A92: 18 - 21

**i** = Imperial (in)  
**m** = Metric (mm)





SAE J-1926 / ISO 11926-1 / MS-16142

Inserts

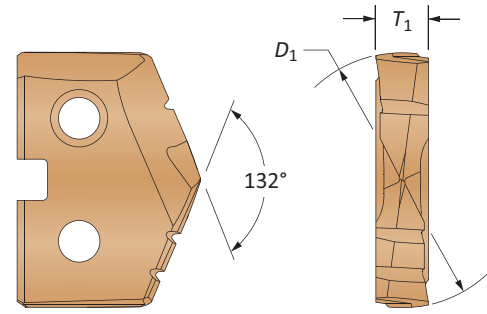

See section A3 for complete T-A insert details

Original T-A® / GEN2 T-A® Drill Inserts

Tube Dash No.	AccuPort Part No.	T-A® Insert Series	Part No.		Insert Screw	Insert Driver	Admissible Tightening Torque*
			Super Cobalt (AM200)	Carbide (AM300®)			
-4	J1926-04Y-063F	Y	45YH-.386	4C1YP-.386	724-IP7-1	8IP-7	7.4 in/lbs (84 N-cm)
-5	J1926-05Z-063F	Z	45ZH-11.5	4C1ZP-11.5	7247-IP7-1	8IP-7	7.4 in/lbs (84 N-cm)
-6	J1926-060-075F	0	450H-13	4C10P-13	72556-IP8-1	8IP-8	15.5 in/lbs (175 N-cm)
-8	J1926-080-075F	0	450H-0022	4C10P-0022	72567-IP8-1	8IP-8	15.5 in/lbs (175 N-cm)
-10	J1926-101-100F	1	451H-20.5	4C11P-20.5	7375-IP9-1	8IP-9	27.0 in/lbs (305 N-cm)
-12	J1926-122-125F	2	452H-25	4C12P-25	7495-IP15-1	8IP-15	61.0 in/lbs (690 N-cm)
-14	J1926-142-125F	2	452H-28	4C12P-28	7495-IP15-1	8IP-15	61.0 in/lbs (690 N-cm)
-16	J1926-162-125F	2	452H-1.231	4C12P-1.231	7495-IP15-1	8IP-15	61.0 in/lbs (690 N-cm)
-20	J1926-203-150F	3	453H-39	1C53A-39	7514-IP20-1	8IP-20	121.3 in/lbs (1370 N-cm)
-24	J1926-243-150F	3	453H-45.5	1C53A-45.5	7514-IP20-1	8IP-20	121.3 in/lbs (1370 N-cm)
-32	J1926-324-150F	4	454H-61.5	-	7514-IP20-1	8IP-20	121.3 in/lbs (1370 N-cm)

\*Tightening torques are calculated with a friction coefficient of  $\mu = 0.14$  and develop 90% of ultimate yield strength

Port Form Drill Inserts

Tube Dash No.	AccuPort Part No.	Part No.		Insert Screw	Insert Driver	Admissible Tightening Torque*
		C3 Carbide (AM200®)	C5 Carbide (TiAlN)			
-4	J1926-04Y-063F	J1926-02-C3H	J1926-02-C5A	72556-IP8-1	8IP-8	15.5 in/lbs (175 N-cm)
-5	J1926-05Z-063F	J1926-03-C3H	J1926-03-C5A	72556-IP8-1	8IP-8	15.5 in/lbs (175 N-cm)
-6	J1926-060-075F	J1926-03-C3H	J1926-03-C5A	72556-IP8-1	8IP-8	15.5 in/lbs (175 N-cm)
-8	J1926-080-075F	J1926-07-C3H	J1926-07-C5A	72556-IP8-1	8IP-8	15.5 in/lbs (175 N-cm)
-10	J1926-101-100F	J1926-04-C3H	J1926-04-C5A	72556-IP8-1	8IP-8	15.5 in/lbs (175 N-cm)
-12	J1926-122-125F	J1926-08-C3H	J1926-08-C5A	72556-IP8-1	8IP-8	15.5 in/lbs (175 N-cm)
-14	J1926-142-125F	J1926-08-C3H	J1926-08-C5A	72556-IP8-1	8IP-8	15.5 in/lbs (175 N-cm)
-16	J1926-162-125F	J1926-09-C3H	J1926-09-C5A	7375-IP9-1	8IP-9	27.0 in/lbs (305 N-cm)
-20	J1926-203-150F	J1926-10-C3H	J1926-10-C5A	7375-IP9-1	8IP-9	27.0 in/lbs (305 N-cm)
-24	J1926-243-150F	J1926-11-C3H	J1926-11-C5A	7375-IP9-1	8IP-9	27.0 in/lbs (305 N-cm)
-32	J1926-324-150F	J1926-12-C3H	J1926-12-C5A	7375-IP9-1	8IP-9	27.0 in/lbs (305 N-cm)

\*Tightening torques are calculated with a friction coefficient of  $\mu = 0.14$  and develop 90% of ultimate yield strength

A92: 30 - 37

A92: 2 - 4

A92: 18 - 21

Y - 2 series T-A inserts sold in multiples of 2  
 3 - 4 series T-A inserts sold in multiples of 1  
 Port form inserts sold in multiples of 2  
 Insert screws sold in multiples of 10

J  
 A DRILLING  
 B BORING  
 C REAMING  
 D BURNISHING  
 E THREADING  
 X SPECIALS

## SAE J-1926 / ISO 11926-1 / MS-16142

### Metric Shank Holders

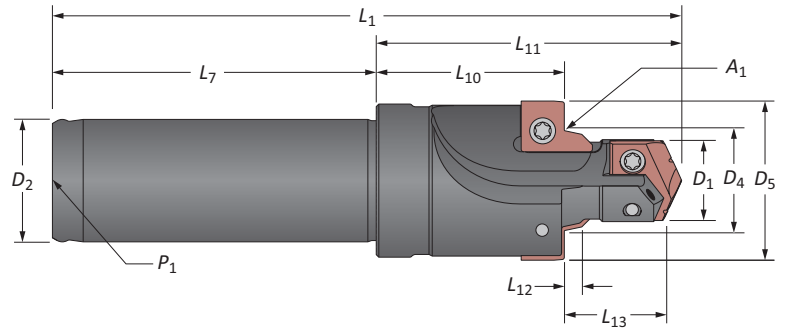

Tube Dash No.	Cutting			Seal Angle			Holder			Shank			Port Thread Size	Part No.
	D <sub>1</sub>	L <sub>13</sub>	D <sub>5</sub>	A <sub>1</sub>	D <sub>4</sub>	L <sub>12</sub>	L <sub>11</sub>	L <sub>10</sub>	L <sub>1</sub>	L <sub>7</sub>	D <sub>2</sub>	P <sub>1</sub>		
-4	0.386	0.551	0.840	12°	0.490	0.106	1.527	0.896	3.180	1.650	0.630	1/16**	7/16-20 UNF-2B	J1926-04Y-16FM
-5	0.453	0.551	0.926	12°	0.553	0.106	1.527	0.885	3.650	1.650	0.630	1/16**	1/2-20 UNF-2B	J1926-05Z-16FM
-6	0.512	0.610	0.989	12°	0.618	0.106	1.857	1.144	3.510	1.650	0.787	1/8**	9/16-18 UNF-2B	J1926-060-20FM
-8	0.689	0.689	1.206	15°	0.813	0.106	1.982	1.150	3.630	1.650	0.787	1/8**	3/4-16 UNF-2B	J1926-080-20FM
-10	0.807	0.787	1.344	15°	0.945	0.106	2.140	1.185	4.230	2.091	0.984	1/8**	7/8-14 UNF-2B	J1926-101-25FM
<b>i</b> -12	0.984	0.906	1.655	15°	1.150	0.138	2.640	1.530	4.920	2.280	1.260	1/4**	1 1/16-12 UN-2B	J1926-122-32FM
-14	1.102	0.906	1.781	15°	1.276	0.138	2.640	1.504	4.920	2.280	1.260	1/4**	1 3/16-12 UN-2B	J1926-142-32FM
-16	1.231	0.906	1.934	15°	1.400	0.138	2.640	1.477	4.920	2.280	1.260	1/4**	1 5/16-12 UN-2B	J1926-162-32FM
-20	1.535	0.906	2.306	15°	1.715	0.138	3.062	1.835	5.640	2.580	1.260	1/4**	1 5/8-12 UN-2B	J1926-203-32FM*
-24	1.791	0.906	2.564	15°	1.965	0.138	3.062	1.778	5.640	2.580	1.260	1/4**	1 7/8-12 UN-2B	J1926-243-32FM*
-32	2.421	0.906	3.470	15°	2.589	0.138	3.812	2.393	6.390	2.580	1.260	1/4**	2 1/2-12 UN-2B	J1926-324-32FM*
<b>m</b> -4	9.80	14.00	21.30	12°	12.50	2.70	38.80	22.80	80.70	41.90	16.00	1/16**	7/16-20 UNF-2B	J1926-04Y-16FM
-5	11.50	14.00	23.50	12°	14.10	2.70	38.80	22.50	92.80	41.90	16.00	1/16**	1/2-20 UNF-2B	J1926-05Z-16FM
-6	13.00	15.50	25.10	12°	15.70	2.70	47.20	29.00	89.10	41.90	20.00	1/8**	9/16-18 UNF-2B	J1926-060-20FM
-8	17.50	17.50	30.60	15°	20.70	2.70	50.30	29.20	92.30	41.90	20.00	1/8**	3/4-16 UNF-2B	J1926-080-20FM
-10	20.50	20.00	34.10	15°	24.00	2.70	54.40	30.10	107.40	53.10	25.00	1/8**	7/8-14 UNF-2B	J1926-101-25FM
<b>m</b> -12	25.00	23.00	42.00	15°	29.20	3.50	67.10	38.90	125.00	57.90	32.00	1/4**	1 1/16-12 UN-2B	J1926-122-32FM
-14	28.00	23.00	45.20	15°	32.40	3.50	67.10	38.20	125.00	57.90	32.00	1/4**	1 3/16-12 UN-2B	J1926-142-32FM
-16	31.20	23.00	49.10	15°	35.60	3.50	67.10	37.50	125.00	57.90	32.00	1/4**	1 5/16-12 UN-2B	J1926-162-32FM
-20	39.00	23.00	58.50	15°	43.60	3.50	77.80	46.60	143.30	65.50	32.00	1/4**	1 5/8-12 UN-2B	J1926-203-32FM*
-24	45.50	23.00	65.10	15°	49.90	3.50	77.80	45.20	143.30	65.50	32.00	1/4**	1 7/8-12 UN-2B	J1926-243-32FM*
-32	61.50	23.00	88.10	15°	65.80	3.50	96.80	60.80	162.30	65.50	32.00	1/4**	2 1/2-12 UN-2B	J1926-324-32FM*

**\*NOTICE:** Due to the cutting forces generated by this tool, a mechanical chuck is required. Please contact Application Engineering with any questions.

\*\* Metric thread to BSP and ISO 7-1

A92: 30 - 37

A92: 2 - 4

A92: 18 - 21

Key on A92: 1

**i** = Imperial (in)  
**m** = Metric (mm)



SAE J-1926 / ISO 11926-1 / MS-16142

Inserts

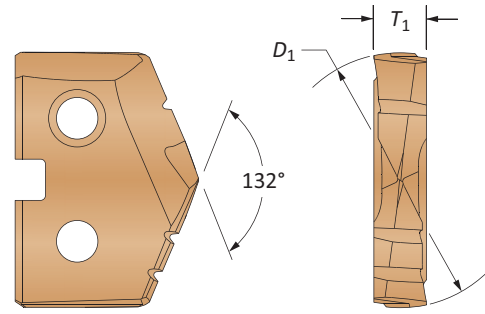

See section A3 for complete T-A insert details

Original T-A® / GEN2 T-A® Drill Inserts

Tube Dash No.	AccuPort Part No.	T-A® Insert Series	Part No.		Insert Screw	Insert Driver	Admissible Tightening Torque**
			Super Cobalt (AM200)	Carbide (AM300®)			
-4	J1926-04Y-16FM	Y	45YH-.386	4C1YP-.386	724-IP7-1	8IP-7	7.4 in/lbs (84 N-cm)
-5	J1926-05Z-16FM	Z	45ZH-11.5	4C1ZP-11.5	7247-IP7-1	8IP-7	7.4 in/lbs (84 N-cm)
-6	J1926-060-20FM	0	450H-13	4C10P-13	72556-IP8-1	8IP-8	15.5 in/lbs (175 N-cm)
-8	J1926-080-20FM	0	450H-0022	4C10P-0022	72567-IP8-1	8IP-8	15.5 in/lbs (175 N-cm)
-10	J1926-101-25FM	1	451H-20.5	4C11P-20.5	7375-IP9-1	8IP-9	27.0 in/lbs (305 N-cm)
-12	J1926-122-32FM	2	452H-25	4C12P-25	7495-IP15-1	8IP-15	61.0 in/lbs (690 N-cm)
-14	J1926-142-32FM	2	452H-28	4C12P-28	7495-IP15-1	8IP-15	61.0 in/lbs (690 N-cm)
-16	J1926-162-32FM	2	452H-1.231	4C12P-1.231	7495-IP15-1	8IP-15	61.0 in/lbs (690 N-cm)
-20	J1926-203-32FM*	3	453H-39	1C53A-39	7514-IP20-1	8IP-20	121.3 in/lbs (1370 N-cm)
-24	J1926-243-32FM*	3	453H-45.5	1C53A-45.5	7514-IP20-1	8IP-20	121.3 in/lbs (1370 N-cm)
-32	J1926-324-32FM*	4	454H-61.5	-	7514-IP20-1	8IP-20	121.3 in/lbs (1370 N-cm)

\*NOTICE: Due to the cutting forces generated by this tool, a mechanical chuck is required. Please contact Application Engineering with any questions.

\*\*Tightening torques are calculated with a friction coefficient of  $\mu = 0.14$  and develop 90% of ultimate yield strength

Port Form Drill Inserts

Tube Dash No.	AccuPort Part No.	Part No.		Insert Screw	Insert Driver	Admissible Tightening Torque**
		C3 Carbide (AM200®)	C5 Carbide (TiAlN)			
-4	J1926-04Y-16FM	J1926-02-C3H	J1926-02-C5A	72556-IP8-1	8IP-8	15.5 in/lbs (175 N-cm)
-5	J1926-05Z-16FM	J1926-03-C3H	J1926-03-C5A	72556-IP8-1	8IP-8	15.5 in/lbs (175 N-cm)
-6	J1926-060-20FM	J1926-03-C3H	J1926-03-C5A	72556-IP8-1	8IP-8	15.5 in/lbs (175 N-cm)
-8	J1926-080-20FM	J1926-07-C3H	J1926-07-C5A	72556-IP8-1	8IP-8	15.5 in/lbs (175 N-cm)
-10	J1926-101-25FM	J1926-04-C3H	J1926-04-C5A	72556-IP8-1	8IP-8	15.5 in/lbs (175 N-cm)
-12	J1926-122-32FM	J1926-08-C3H	J1926-08-C5A	72556-IP8-1	8IP-8	15.5 in/lbs (175 N-cm)
-14	J1926-142-32FM	J1926-08-C3H	J1926-08-C5A	72556-IP8-1	8IP-8	15.5 in/lbs (175 N-cm)
-16	J1926-162-32FM	J1926-09-C3H	J1926-09-C5A	7375-IP9-1	8IP-9	27.0 in/lbs (305 N-cm)
-20	J1926-203-32FM*	J1926-10-C3H	J1926-10-C5A	7375-IP9-1	8IP-9	27.0 in/lbs (305 N-cm)
-24	J1926-243-32FM*	J1926-11-C3H	J1926-11-C5A	7375-IP9-1	8IP-9	27.0 in/lbs (305 N-cm)
-32	J1926-324-32FM*	J1926-12-C3H	J1926-12-C5A	7375-IP9-1	8IP-9	27.0 in/lbs (305 N-cm)

\*NOTICE: Due to the cutting forces generated by this tool, a mechanical chuck is required. Please contact Application Engineering with any questions.

\*\*Tightening torques are calculated with a friction coefficient of  $\mu = 0.14$  and develop 90% of ultimate yield strength

A92: 30 - 37

A92: 2 - 4

A92: 18 - 21

Y - 2 series T-A inserts sold in multiples of 2  
 3 - 4 series T-A inserts sold in multiples of 1  
 Port form inserts sold in multiples of 2  
 Insert screws sold in multiples of 10

**SAE J-1926 / ISO 11926-1 / MS-16142**

Imperial Shank Holders | Extended Minor Diameter Lengths ( $L_{13}$ )

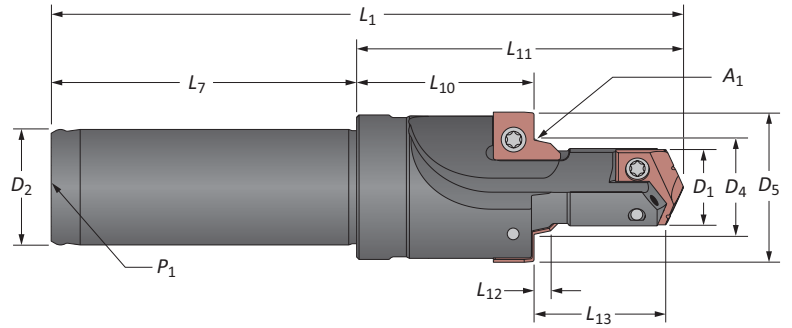

Tube Dash No.	Cutting			Seal Angle			Holder			Shank			Port Thread Size	Part No.
	$D_1$	$L_{13}$	$D_5$	$A_1$	$D_4$	$L_{12}$	$L_{11}$	$L_{10}$	$L_1$	$L_7$	$D_2$	$P_1$		
-4	0.386	0.801	0.840	12°	0.490	0.106	1.777	0.896	3.650	1.875	0.625	1/16	7/16-20 UNF-2B	X1926-04Y-063F
-5	0.453	0.801	0.926	12°	0.553	0.106	1.777	0.885	3.650	1.875	0.625	1/16	1/2-20 UNF-2B	X1926-05Z-063F
-6	0.512	0.860	0.989	12°	0.618	0.106	2.107	1.144	4.070	1.969	0.750	1/8	9/16-18 UNF-2B	X1926-060-075F
-8	0.689	0.939	1.206	15°	0.813	0.106	2.232	1.150	4.200	1.969	0.750	1/8	3/4-16 UNF-2B	X1926-080-075F
-10	0.807	1.037	1.344	15°	0.945	0.106	2.390	1.185	4.670	2.281	1.000	1/8	7/8-14 UNF-2B	X1926-101-100F
<b>i</b> -12	0.984	1.156	1.655	15°	1.150	0.138	2.890	1.530	5.170	2.281	1.250	1/4	1 1/16-12 UN-2B	X1926-122-125F
-14	1.102	1.156	1.781	15°	1.276	0.138	2.890	1.504	5.170	2.281	1.250	1/4	1 3/16-12 UN-2B	X1926-142-125F
-16	1.231	1.156	1.934	15°	1.400	0.138	2.890	1.477	5.170	2.281	1.250	1/4	1 5/16-12 UN-2B	X1926-162-125F
-20	1.535	1.156	2.306	15°	1.715	0.138	3.312	1.835	6.000	2.688	1.500	1/4	1 5/8-12 UN-2B	X1926-203-150F
-24	1.791	1.156	2.564	15°	1.965	0.138	3.312	1.778	6.000	2.688	1.500	1/4	1 7/8-12 UN-2B	X1926-243-150F
-32	2.421	1.156	3.470	15°	2.589	0.138	4.062	2.393	6.750	2.688	1.500	1/4	2 1/2-12 UN-2B	X1926-324-150F
<b>m</b> -4	9.80	20.30	21.30	12°	12.50	2.70	45.10	22.80	92.80	47.60	15.90	1/16	7/16-20 UNF-2B	X1926-04Y-063F
-5	11.50	20.30	23.50	12°	14.10	2.70	45.10	22.50	92.80	47.60	15.90	1/16	1/2-20 UNF-2B	X1926-05Z-063F
-6	13.00	21.80	25.10	12°	15.70	2.70	53.50	29.00	103.50	50.00	19.10	1/8	9/16-18 UNF-2B	X1926-060-075F
-8	17.50	23.80	30.60	15°	20.70	2.70	56.70	29.20	106.70	50.00	19.10	1/8	3/4-16 UNF-2B	X1926-080-075F
-10	20.50	26.30	34.10	15°	24.00	2.70	60.70	30.10	118.60	57.90	25.40	1/8	7/8-14 UNF-2B	X1926-101-100F
<b>m</b> -12	25.00	29.30	42.00	15°	29.20	3.50	73.40	38.90	131.30	57.90	31.80	1/4	1 1/16-12 UN-2B	X1926-122-125F
-14	28.00	29.30	45.20	15°	32.40	3.50	73.40	38.20	131.30	57.90	31.80	1/4	1 3/16-12 UN-2B	X1926-142-125F
-16	31.20	29.30	49.10	15°	35.60	3.50	73.40	37.50	131.30	57.90	31.80	1/4	1 5/16-12 UN-2B	X1926-162-125F
-20	39.00	29.30	58.50	15°	43.60	3.50	84.10	46.60	152.40	68.30	38.10	1/4	1 5/8-12 UN-2B	X1926-203-150F
-24	45.50	29.30	65.10	15°	49.90	3.50	84.10	45.20	152.40	68.30	38.10	1/4	1 7/8-12 UN-2B	X1926-243-150F
-32	61.50	29.30	88.10	15°	65.80	3.50	103.20	60.80	171.40	68.30	38.10	1/4	2 1/2-12 UN-2B	X1926-324-150F

A92: 30 - 37 Key on A92: 1

A92: 2 - 4

A92: 18 - 21

**i** = Imperial (in)  
**m** = Metric (mm)



SAE J-1926 / ISO 11926-1 / MS-16142

Inserts

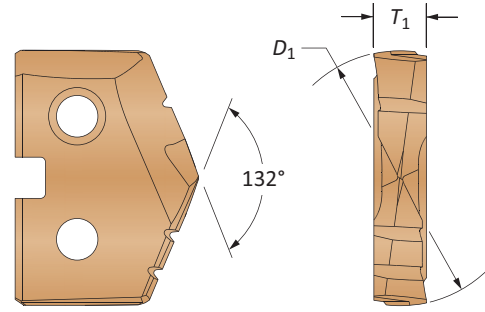

See section A3 for complete T-A insert details

Original T-A® / GEN2 T-A® Drill Inserts

Tube Dash No.	AccuPort Part No.	T-A® Insert Series	Part No.		Insert Screw	Insert Driver	Admissible Tightening Torque*
			Super Cobalt (AM200)	Carbide (AM300®)			
-4	X1926-04Y-063F	Y	45YH-.386	4C1YP-.386	724-IP7-1	8IP-7	7.4 in/lbs (84 N-cm)
-5	X1926-05Z-063F	Z	45ZH-11.5	4C1ZP-11.5	7247-IP7-1	8IP-7	7.4 in/lbs (84 N-cm)
-6	X1926-060-075F	0	450H-13	4C10P-13	72556-IP8-1	8IP-8	15.5 in/lbs (175 N-cm)
-8	X1926-080-075F	0	450H-0022	4C10P-0022	72567-IP8-1	8IP-8	15.5 in/lbs (175 N-cm)
-10	X1926-101-100F	1	451H-20.5	4C11P-20.5	7375-IP9-1	8IP-9	27.0 in/lbs (305 N-cm)
-12	X1926-122-125F	2	452H-25	4C12P-25	7495-IP15-1	8IP-15	61.0 in/lbs (690 N-cm)
-14	X1926-142-125F	2	452H-28	4C12P-28	7495-IP15-1	8IP-15	61.0 in/lbs (690 N-cm)
-16	X1926-162-125F	2	452H-1.231	4C12P-1.231	7495-IP15-1	8IP-15	61.0 in/lbs (690 N-cm)
-20	X1926-203-150F	3	453H-39	1C53A-39	7514-IP20-1	8IP-20	121.3 in/lbs (1370 N-cm)
-24	X1926-243-150F	3	453H-45.5	1C53A-45.5	7514-IP20-1	8IP-20	121.3 in/lbs (1370 N-cm)
-32	X1926-324-150F	4	454H-61.5	-	7514-IP20-1	8IP-20	121.3 in/lbs (1370 N-cm)

\*Tightening torques are calculated with a friction coefficient of  $\mu = 0.14$  and develop 90% of ultimate yield strength

Port Form Drill Inserts

Tube Dash No.	AccuPort Part No.	Part No.		Insert Screw	Insert Driver	Admissible Tightening Torque*
		C3 Carbide (AM200®)	C5 Carbide (TiAlN)			
-4	X1926-04Y-063F	J1926-02-C3H	J1926-02-C5A	72556-IP8-1	8IP-8	15.5 in/lbs (175 N-cm)
-5	X1926-05Z-063F	J1926-03-C3H	J1926-03-C5A	72556-IP8-1	8IP-8	15.5 in/lbs (175 N-cm)
-6	X1926-060-075F	J1926-03-C3H	J1926-03-C5A	72556-IP8-1	8IP-8	15.5 in/lbs (175 N-cm)
-8	X1926-080-075F	J1926-07-C3H	J1926-07-C5A	72556-IP8-1	8IP-8	15.5 in/lbs (175 N-cm)
-10	X1926-101-100F	J1926-04-C3H	J1926-04-C5A	72556-IP8-1	8IP-8	15.5 in/lbs (175 N-cm)
-12	X1926-122-125F	J1926-08-C3H	J1926-08-C5A	72556-IP8-1	8IP-8	15.5 in/lbs (175 N-cm)
-14	X1926-142-125F	J1926-08-C3H	J1926-08-C5A	72556-IP8-1	8IP-8	15.5 in/lbs (175 N-cm)
-16	X1926-162-125F	J1926-09-C3H	J1926-09-C5A	7375-IP9-1	8IP-9	27.0 in/lbs (305 N-cm)
-20	X1926-203-150F	J1926-10-C3H	J1926-10-C5A	7375-IP9-1	8IP-9	27.0 in/lbs (305 N-cm)
-24	X1926-243-150F	J1926-11-C3H	J1926-11-C5A	7375-IP9-1	8IP-9	27.0 in/lbs (305 N-cm)
-32	X1926-324-150F	J1926-12-C3H	J1926-12-C5A	7375-IP9-1	8IP-9	27.0 in/lbs (305 N-cm)

\*Tightening torques are calculated with a friction coefficient of  $\mu = 0.14$  and develop 90% of ultimate yield strength

A92: 30 - 37

A92: 2 - 4

A92: 18 - 21

Y - 2 series T-A inserts sold in multiples of 2  
 3 - 4 series T-A inserts sold in multiples of 1  
 Port form inserts sold in multiples of 2  
 Insert screws sold in multiples of 10

## ISO 6149-1:2006 / SAE J-2244/1

### Metric Shank Holders

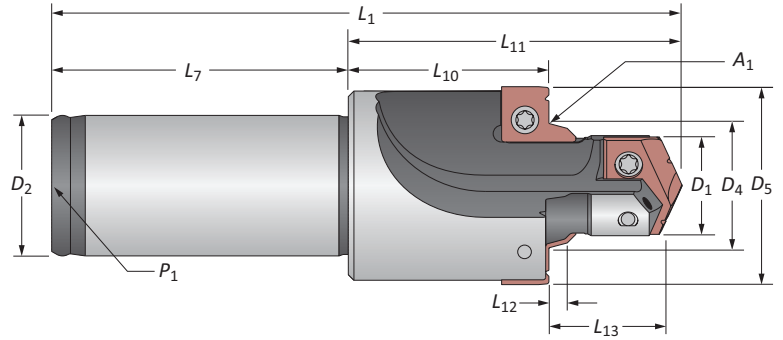

Tube Dash No.	Cutting			Seal Angle			Holder			Shank			Port Thread Size	Part No.
	D <sub>1</sub>	L <sub>13</sub>	D <sub>5</sub>	A <sub>1</sub>	D <sub>4</sub>	L <sub>12</sub>	L <sub>11</sub>	L <sub>10</sub>	L <sub>1</sub>	L <sub>7</sub>	D <sub>2</sub>	P <sub>1</sub>		
-4	0.413	0.556	0.945	15°	0.544	0.102	1.527	0.876	3.180	1.650	0.630	1/16**	M12 X 1.5	I6149-04RY-16FM
-5	0.492	0.556	1.024	15°	0.623	0.102	1.527	0.858	3.180	1.650	0.630	1/16**	M14 X 1.5	I6149-05RZ-16FM
-6	0.571	0.615	1.102	15°	0.702	0.102	1.857	1.116	3.510	1.650	0.787	1/8**	M16 X 1.5	I6149-06R0-20FM
-8	0.650	0.674	1.181	15°	0.781	0.102	1.982	1.164	3.630	1.650	0.787	1/8**	M18 X 1.5	I6149-08R0-20FM
-10	0.807	0.717	1.339	15°	0.938	0.102	2.140	1.246	4.230	2.091	0.984	1/8**	M22 X 1.5	I6149-10R1-25FM
<b>i</b> -12	0.984	0.874	1.575	15°	1.159	0.130	2.640	1.552	4.920	2.280	1.260	1/4**	M27 X 2	I6149-12R2-32FM
-14	1.102	0.874	1.733	15°	1.277	0.130	2.640	1.526	4.920	2.280	1.260	1/4**	M30 X 2	I6149-14R2-32FM
-16	1.220	0.874	1.929	15°	1.395	0.130	2.640	1.499	4.920	2.280	1.260	1/4**	M33 X 2	I6149-16R2-32FM
-20	1.575	0.895	2.362	15°	1.749	0.130	3.062	1.828	5.640	2.280	1.260	1/4**	M42 X 2	I6149-20R3-32FM*
-24	1.811	0.993	2.602	15°	1.985	0.130	3.062	1.676	5.640	2.280	1.260	1/4**	M48 X 2	I6149-24R3-32FM*
-32	2.283	1.092	2.992	15°	2.458	0.130	3.812	2.228	6.390	2.280	1.260	1/4**	M60 X 2	I6149-32R4-32FM*
<b>m</b> -4	10.50	14.10	24.00	15°	13.81	2.60	38.80	22.20	80.70	41.90	16.00	1/16**	M12 X 1.5	I6149-04RY-16FM
-5	12.50	14.10	26.00	15°	15.80	2.60	38.80	21.80	80.70	41.90	16.00	1/16**	M14 X 1.5	I6149-05RZ-16FM
-6	14.50	15.60	28.00	15°	17.80	2.60	47.20	28.30	89.10	41.90	20.00	1/8**	M16 X 1.5	I6149-06R0-20FM
-8	16.50	17.10	30.00	15°	19.80	2.60	50.30	29.60	92.20	41.90	20.00	1/8**	M18 X 1.5	I6149-08R0-20FM
-10	20.50	18.20	34.00	15°	23.80	2.60	54.40	31.60	107.50	53.10	25.00	1/8**	M22 X 1.5	I6149-10R1-25FM
<b>m</b> -12	25.00	22.20	40.00	15°	29.40	3.30	67.10	39.40	125.00	57.90	32.00	1/4**	M27 X 2	I6149-12R2-32FM
-14	28.00	22.20	44.00	15°	32.40	3.30	67.10	38.80	125.00	57.90	32.00	1/4**	M30 X 2	I6149-14R2-32FM
-16	31.00	22.20	49.00	15°	35.40	3.30	67.10	38.10	125.00	57.90	32.00	1/4**	M33 X 2	I6149-16R2-32FM
-20	40.00	22.70	60.00	15°	44.40	3.30	77.80	46.40	143.30	57.90	32.00	1/4**	M42 X 2	I6149-20R3-32FM*
-24	46.00	25.20	66.10	15°	50.40	3.30	77.80	42.60	143.30	57.90	32.00	1/4**	M48 X 2	I6149-24R3-32FM*
-32	58.00	27.70	76.00	15°	62.40	3.30	96.80	56.60	162.30	57.90	32.00	1/4**	M60 X 2	I6149-32R4-32FM*

**\*NOTICE:** Due to the cutting forces generated by this tool, a mechanical chuck is required. Please contact Application Engineering with any questions.

\*\* Metric thread to BSP and ISO 7-1

A92: 30 - 37

A92: 2 - 4

A92: 22 - 25

Key on A92: 1

**i** = Imperial (in)  
**m** = Metric (mm)



ISO 6149-1:2006 / SAE J-2244/1

Inserts

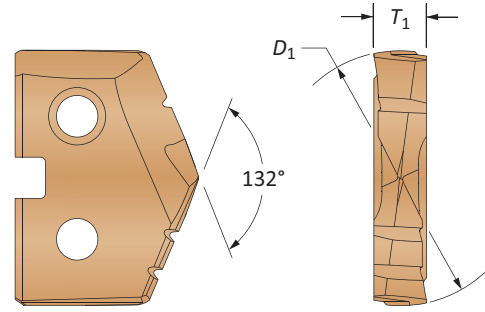

See section A3 for complete T-A insert details

Original T-A® / GEN2 T-A® Drill Inserts

Tube Dash No.	AccuPort Part No.	T-A® Insert Series	Part No.		Insert Screw	Insert Driver	Admissible Tightening Torque**
			Super Cobalt (AM200)	Carbide (AM300®)			
-4	I6149-04RY-16FM	Y	45YH-10.5	4C1YP-10.5	724-IP7-1	8IP-7	7.4 in/lbs (84 N-cm)
-5	I6149-05RZ-16FM	Z	45ZH-12.5	4C1ZP-12.5	7247-IP7-1	8IP-7	7.4 in/lbs (84 N-cm)
-6	I6149-06R0-20FM	0	450H-14.5	4C10P-14.5	72556-IP8-1	8IP-8	15.5 in/lbs (175 N-cm)
-8	I6149-08R0-20FM	0	450H-16.5	4C10P-16.5	72567-IP8-1	8IP-8	15.5 in/lbs (175 N-cm)
-10	I6149-10R1-25FM	1	451H-20.5	4C11P-20.5	7375-IP9-1	8IP-9	27.0 in/lbs (305 N-cm)
-12	I6149-12R2-32FM	2	452H-25	4C12P-25	7495-IP15-1	8IP-15	61.0 in/lbs (690 N-cm)
-14	I6149-14R2-32FM	2	452H-28	4C12P-28	7495-IP15-1	8IP-15	61.0 in/lbs (690 N-cm)
-16	I6149-16R2-32FM	2	452H-31	4C12P-31	7495-IP15-1	8IP-15	61.0 in/lbs (690 N-cm)
-20	I6149-20R3-32FM*	3	453H-40	1C53A-40	7514-IP20-1	8IP-20	121.3 in/lbs (1370 N-cm)
-24	I6149-24R3-32FM*	3	453H-46	1C53A-46	7514-IP20-1	8IP-20	121.3 in/lbs (1370 N-cm)
-32	I6149-32R4-32FM*	4	454H-58	-	7514-IP20-1	8IP-20	121.3 in/lbs (1370 N-cm)

\*NOTICE: Due to the cutting forces generated by this tool, a mechanical chuck is required. Please contact Application Engineering with any questions.

\*\*Tightening torques are calculated with a friction coefficient of  $\mu = 0.14$  and develop 90% of ultimate yield strength

Port Form Drill Inserts

Tube Dash No.	AccuPort Part No.	Part No. - C3 Carbide (AM200®)		Part No. - C5 Carbide (TiAlN)		Insert Screw	Insert Driver	Admissible Tightening Torque**
		ID Ridge	No ID Ridge	ID Ridge	No ID Ridge			
-4	I6149-04RY-16FM	I6149-04R-C3H	I6149-04-C3H	I6149-04R-C5A	I6149-04-C5A	72556-IP8-1	8IP-8	15.5 in/lbs (175 N-cm)
-5	I6149-05RZ-16FM	I6149-04R-C3H	I6149-04-C3H	I6149-04R-C5A	I6149-04-C5A	72556-IP8-1	8IP-8	15.5 in/lbs (175 N-cm)
-6	I6149-06R0-20FM	I6149-06R-C3H	I6149-06-C3H	I6149-06R-C5A	I6149-06-C5A	72556-IP8-1	8IP-8	15.5 in/lbs (175 N-cm)
-8	I6149-08R0-20FM	I6149-06R-C3H	I6149-06-C3H	I6149-06R-C5A	I6149-06-C5A	72556-IP8-1	8IP-8	15.5 in/lbs (175 N-cm)
-10	I6149-10R1-25FM	I6149-04R-C3H	I6149-04-C3H	I6149-04R-C5A	I6149-04-C5A	72556-IP8-1	8IP-8	15.5 in/lbs (175 N-cm)
-12	I6149-12R2-32FM	I6149-12R-C3H	I6149-12-C3H	I6149-12R-C5A	I6149-12-C5A	72556-IP8-1	8IP-8	15.5 in/lbs (175 N-cm)
-14	I6149-14R2-32FM	I6149-14R-C3H	I6149-14-C3H	I6149-14R-C5A	I6149-14-C5A	72556-IP8-1	8IP-8	15.5 in/lbs (175 N-cm)
-16	I6149-16R2-32FM	I6149-16R-C3H	I6149-16-C3H	I6149-16R-C5A	I6149-16-C5A	7375-IP9-1	8IP-9	27.0 in/lbs (305 N-cm)
-20	I6149-20R3-32FM*	I6149-20R-C3H	I6149-20-C3H	I6149-20R-C5A	I6149-20-C5A	7375-IP9-1	8IP-9	27.0 in/lbs (305 N-cm)
-24	I6149-24R3-32FM*	I6149-24R-C3H	I6149-24-C3H	I6149-24R-C5A	I6149-24-C5A	7375-IP9-1	8IP-9	27.0 in/lbs (305 N-cm)
-32	I6149-32R4-32FM*	I6149-32R-C3H	I6149-32-C3H	I6149-32R-C5A	I6149-32-C5A	7375-IP9-1	8IP-9	27.0 in/lbs (305 N-cm)

\*NOTICE: Due to the cutting forces generated by this tool, a mechanical chuck is required. Please contact Application Engineering with any questions.

\*\*Tightening torques are calculated with a friction coefficient of  $\mu = 0.14$  and develop 90% of ultimate yield strength

A92: 30 - 37

A92: 2 - 4

A92: 22 - 25

Y - 2 series T-A inserts sold in multiples of 2  
 3 - 4 series T-A inserts sold in multiples of 1  
 Port form inserts sold in multiples of 2  
 Insert screws sold in multiples of 10

SAE AS5202 / AND10050

Imperial Shank Holders

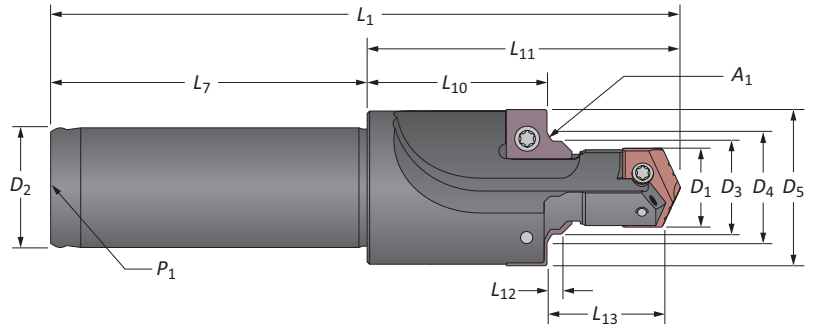

Tube Dash No.	Cutting				Seal Angle			Holder				Shank			Port Thread Size	Port Thread Size*	Part No.
	D <sub>1</sub>	D <sub>1</sub> *	L <sub>13</sub>	D <sub>5</sub>	A <sub>1</sub>	D <sub>4</sub>	L <sub>12</sub>	D <sub>3</sub>	L <sub>11</sub>	L <sub>10</sub>	L <sub>1</sub>	L <sub>7</sub>	D <sub>2</sub>	P <sub>1</sub>			
-4	0.390	0.386	0.661	0.875	60°	0.564	0.083	0.454	1.637	0.896	3.510	1.875	0.625	1/16	7/16-20 UNJF-3B	7/16-20 UNF-3B	AS5202-04Y-063F
-5	0.453	0.451	0.661	0.916	60°	0.625	0.083	0.517	1.637	0.882	3.510	1.875	0.625	1/16	1/2-20 UNJF-3B	1/2-20 UNF-3B	AS5202-05Z-063F
-6	0.510	0.506	0.714	0.979	60°	0.688	0.083	0.580	1.940	1.119	3.910	1.969	0.750	1/8	9/16-18 UNJF-3B	9/16-18 UNF-3B	AS5202-06Z-075F
-8	0.689	0.688	0.839	1.198	60°	0.875	0.094	0.769	2.107	1.125	4.080	1.969	0.750	1/8	3/4-16 UNJF-3B	3/4-16 UNF-3B	AS5202-080-075F
-10	0.807	0.801	0.935	1.354	60°	1.002	0.107	0.896	2.290	1.189	4.570	2.281	1.000	1/8	7/8-14 UNJF-3B	7/8-14 UNF-3B	AS5202-101-100F
i -12	0.984	0.976	1.069	1.635	60°	1.237	0.125	1.086	2.765	1.494	5.050	2.281	1.250	1/4	1 1/16-12 UNJ-3B	1 1/16-12 UN-3B	AS5202-122-125F
-14	1.109	1.102	1.069	1.775	60°	1.363	0.125	1.211	2.765	1.465	5.050	2.281	1.250	1/4	1 3/16-12 UNJ-3B	1 3/16-12 UN-3B	AS5202-142-125F
-16	1.234	1.226	1.069	1.920	60°	1.487	0.125	1.336	2.765	1.437	5.050	2.281	1.250	1/4	1 5/16-12 UNJ-3B	1 5/16-12 UN-3B	AS5202-162-125F
-20	1.547	1.535	1.121	2.280	60°	1.799	0.125	1.648	3.187	1.745	5.880	2.688	1.500	1/4	1 5/8-12 UNJ-3B	1 5/8-12 UN-3B	AS5202-203-150F
-24	1.797	1.791	1.132	2.570	60°	2.050	0.125	1.898	3.187	1.676	5.880	2.688	1.500	1/4	1 7/8-12 UNJ-3B	1 7/8-12 UN-3B	AS5202-243-150F
-32	2.421	2.413	1.373	3.490	60°	2.676	0.125	2.524	3.687	1.802	6.380	2.688	1.500	1/4	2 1/2-12 UNJ-3B	2 1/2-12 UN-3B	AS5202-324-150F
-4	9.90	9.80	16.79	22.23	60°	14.34	2.11	11.53	41.58	22.76	89.20	47.63	15.88	1/16	7/16-20 UNJF-3B	7/16-20 UNF-3B	AS5202-04Y-063F
-5	11.50	11.45	16.79	23.27	60°	15.88	2.11	13.13	41.58	22.39	89.20	47.63	15.88	1/16	1/2-20 UNJF-3B	1/2-20 UNF-3B	AS5202-05Z-063F
-6	12.95	12.85	18.14	24.87	60°	17.46	2.11	14.73	49.28	28.43	99.29	50.01	19.05	1/8	9/16-18 UNJF-3B	9/16-18 UNF-3B	AS5202-06Z-075F
-8	17.50	17.46	21.31	30.43	60°	22.23	2.39	19.53	53.52	28.57	103.53	50.01	19.05	1/8	3/4-16 UNJF-3B	3/4-16 UNF-3B	AS5202-080-075F
-10	20.50	20.35	23.75	34.39	60°	25.46	2.72	22.76	58.17	30.19	116.10	57.94	25.40	1/8	7/8-14 UNJF-3B	7/8-14 UNF-3B	AS5202-101-100F
m -12	25.00	24.80	27.15	41.53	60°	31.42	3.18	27.58	70.23	37.94	128.17	57.94	31.75	1/4	1 1/16-12 UNJ-3B	1 1/16-12 UN-3B	AS5202-122-125F
-14	28.17	28.00	27.15	45.09	60°	34.61	3.18	30.76	70.23	37.22	128.17	57.94	31.75	1/4	1 3/16-12 UNJ-3B	1 3/16-12 UN-3B	AS5202-142-125F
-16	31.34	31.15	27.15	48.77	60°	37.77	3.18	33.93	70.23	36.51	128.17	57.94	31.75	1/4	1 5/16-12 UNJ-3B	1 5/16-12 UN-3B	AS5202-162-125F
-20	39.29	39.00	28.47	57.91	60°	45.69	3.18	41.86	80.95	44.32	149.23	68.28	38.10	1/4	1 5/8-12 UNJ-3B	1 5/8-12 UN-3B	AS5202-203-150F
-24	45.64	45.50	28.75	65.28	60°	52.07	3.18	48.21	80.95	42.58	149.23	68.28	38.10	1/4	1 7/8-12 UNJ-3B	1 7/8-12 UN-3B	AS5202-243-150F
-32	61.49	61.30	34.87	88.65	60°	67.97	3.18	64.11	93.65	45.78	161.93	68.28	38.10	1/4	2 1/2-12 UNJ-3B	2 1/2-12 UN-3B	AS5202-324-150F

\*AND10050 specifications shown in red

A DRILLING  
B BORING  
C REAMING  
D BURNISHING  
E THREADING  
X SPECIALS

A92: 30 - 37 Key on A92: 1

A92: 2 - 4

A92: 26 - 27

i = Imperial (in)  
m = Metric (mm)





SAE AS5202 / AND10050

Inserts

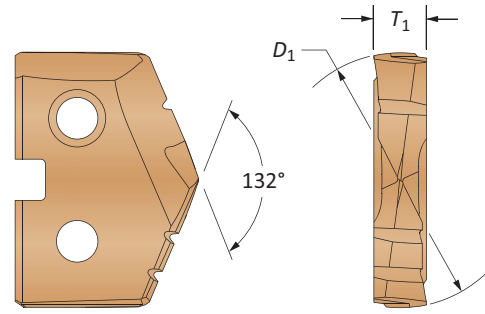

See section A3 for complete T-A insert details

Original T-A® / GEN2 T-A® Drill Inserts

Tube Dash No.	AccuPort Part No.	T-A® Insert Series	Part No.				Insert Screw	Insert Driver	Admissible Tightening Torque*
			Super Cobalt (AM200®)		Carbide (AM300®)				
-4	AS5202-04Y-063F	Y	45YH-.390	45YH-.386	4C1YP-.390	4C1YP-.386	724-IP7-1	8IP-7	7.4 in/lbs (84 N-cm)
-5	AS5202-05Z-063F	Z	45ZH-11.5	45ZH-.451	4C1ZP-11.5	4C1ZP-.451	7247-IP7-1	8IP-7	7.4 in/lbs (84 N-cm)
-6	AS5202-06Z-075F	Z	45ZH-.510	45ZH-.506	4C1ZP-.510	4C1ZP-.506	72567-IP7-1	8IP-7	7.4 in/lbs (84 N-cm)
-8	AS5202-080-075F	0	450H-17.5	450H-0022	4C10P-17.5	4C10P-0022	72567-IP8-1	8IP-8	15.5 in/lbs (175 N-cm)
-10	AS5202-101-100F	1	451H-20.5	451H-.801	4C11P-20.5	4C11P-.801	739-IP9-1	8IP-9	27.0 in/lbs (305 N-cm)
-12	AS5202-122-125F	2	452H-25	452H-.976	4C12P-25	4C12P-.976	7495-IP15-1	8IP-15	61.0 in/lbs (690 N-cm)
-14	AS5202-142-125F	2	452H-1.109	452H-28	4C12P-1.109	4C12P-28	7495-IP15-1	8IP-15	61.0 in/lbs (690 N-cm)
-16	AS5202-162-125F	2	452H-1.234	452H-1.226	4C12P-1.234	4C12P-1.226	7495-IP15-1	8IP-15	61.0 in/lbs (690 N-cm)
-20	AS5202-203-150F	3	453H-1.547	453H-39	1C53A-1.547	1C53A-39	7514-IP20-1	8IP-20	121.3 in/lbs (1370 N-cm)
-24	AS5202-243-150F	3	453H-1.797	453H-45.5	1C53A-1.797	1C53A-45.5	7514-IP20-1	8IP-20	121.3 in/lbs (1370 N-cm)
-32	AS5202-324-150F	4	454H-2.421	454H-2.413	-	-	7514-IP20-1	8IP-20	121.3 in/lbs (1370 N-cm)

\*Tightening torques are calculated with a friction coefficient of  $\mu = 0.14$  and develop 90% of ultimate yield strength

NOTE: AND10050 specifications shown in red

Port Form Drill Inserts

Tube Dash No.	AccuPort Part No.	Part No.		Insert Driver	Admissible Tightening Torque*
		C5 Carbide (TiAlN)	Insert Screw		
-4	AS5202-04Y-063F	AS5202-04-C5A	72556-IP8-1	8IP-8	15.5 in/lbs (175 N-cm)
-5	AS5202-05Z-063F	AS5202-05-C5A	72556-IP8-1	8IP-8	15.5 in/lbs (175 N-cm)
-6	AS5202-06Z-075F	AS5202-06-C5A	72556-IP8-1	8IP-8	15.5 in/lbs (175 N-cm)
-8	AS5202-080-075F	AS5202-08-C5A	72556-IP8-1	8IP-8	15.5 in/lbs (175 N-cm)
-10	AS5202-101-100F	AS5202-10-C5A	7495-IP15-1	8IP-15	61.0 in/lbs (690 N-cm)
-12	AS5202-122-125F	AS5202-12-C5A	7495-IP15-1	8IP-15	61.0 in/lbs (690 N-cm)
-14	AS5202-142-125F	AS5202-14-C5A	7495-IP15-1	8IP-15	61.0 in/lbs (690 N-cm)
-16	AS5202-162-125F	AS5202-16-C5A	7495-IP15-1	8IP-15	61.0 in/lbs (690 N-cm)
-20	AS5202-203-150F	AS5202-20-C5A	7495-IP15-1	8IP-15	61.0 in/lbs (690 N-cm)
-24	AS5202-243-150F	AS5202-24-C5A	7495-IP15-1	8IP-15	61.0 in/lbs (690 N-cm)
-32	AS5202-324-150F	AS5202-32-C5A	7495-IP15-1	8IP-15	61.0 in/lbs (690 N-cm)

\*Tightening torques are calculated with a friction coefficient of  $\mu = 0.14$  and develop 90% of ultimate yield strength

Key on A92-1

A92: 30 - 37

A92: 2 - 4

A92: 26 - 27

Y - 2 series T-A inserts sold in multiples of 2  
 3 - 4 series T-A inserts sold in multiples of 1  
 Port form inserts sold in multiples of 2  
 Insert screws sold in multiples of 10

### JDS-G173.1

#### Metric Shank Holders

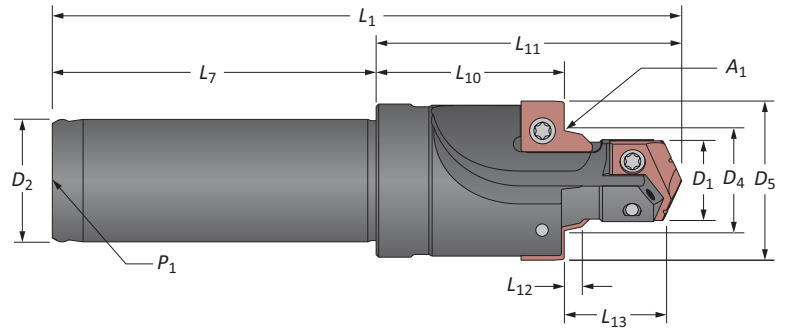

Tube Dash No.	Cutting			Seal Angle			Holder			Shank			Port Thread Size	Part No.
	D <sub>1</sub>	L <sub>13</sub>	D <sub>5</sub>	A <sub>1</sub>	D <sub>4</sub>	L <sub>12</sub>	L <sub>11</sub>	L <sub>10</sub>	L <sub>1</sub>	L <sub>7</sub>	D <sub>2</sub>	BSPT TAP		
-4	0.413	0.709	0.945	15°	0.547	0.104	1.670	0.875	3.320	1.650	0.630	1/16**	M12 X 1.5	G1731-04Y-16FM
-5	0.492	0.709	1.024	15°	0.626	0.104	1.670	0.858	3.320	1.650	0.630	1/16**	M14 X 1.5	G1731-05Z-16FM
-6	0.571	0.748	1.142	15°	0.705	0.104	1.977	1.117	3.630	1.650	0.787	1/8**	M16 X 1.5	G1731-06O-20FM
-8	0.650	0.827	1.220	15°	0.783	0.104	2.127	1.161	3.770	1.650	0.787	1/8**	M18 X 1.5	G1731-08O-20FM
-10	0.807	0.866	1.378	15°	0.941	0.104	2.280	1.246	4.370	2.090	0.984	1/8**	M22 X 1.5	G1731-101-25FM
-12	0.984	1.063	1.614	15°	1.161	0.132	2.820	1.553	5.100	2.280	1.260	1/4**	M27 X 2	G1731-122-32FM
<b>i</b> -14	1.102	1.063	1.732	15°	1.280	0.132	2.820	1.526	5.100	2.280	1.260	1/4**	M30 X 2	G1731-142-32FM
-16	1.221	1.063	1.969	15°	1.398	0.132	2.820	1.500	5.100	2.280	1.260	1/4**	M33 X 2	G1731-162-32FM
-18	1.417	1.063	2.165	15°	1.594	0.132	3.207	1.844	5.780	2.580	1.260	1/4**	M38 X 2	G1731-183-32FM*
-20	1.575	1.063	2.402	15°	1.752	0.132	3.207	1.809	5.780	2.580	1.260	1/4**	M42 X 2	G1731-203-32FM*
-24	1.811	1.142	2.638	15°	1.988	0.132	3.207	1.687	5.780	2.580	1.260	1/4**	M48 X 2	G1731-243-32FM*
-32	2.284	1.260	3.031	15°	2.461	0.132	3.967	2.300	6.550	2.580	1.260	1/4**	M60 X 2	G1731-324-32FM*
C***	0.728	0.787	1.299	15°	0.862	0.104	2.140	1.281	4.230	2.090	0.984	1/8**	M20 X 1.5	G1731-CV1-25FM
<hr/>														
-4	10.50	18.00	24.00	15°	13.90	2.65	42.42	22.20	84.50	41.90	16.00	1/16**	M12 X 1.5	G1731-04Y-16FM
-5	12.50	18.00	26.00	15°	15.90	2.65	42.42	21.80	84.50	41.90	16.00	1/16**	M14 X 1.5	G1731-05Z-16FM
-6	14.50	19.00	29.00	15°	17.90	2.65	50.22	28.40	92.20	41.90	20.00	1/8**	M16 X 1.5	G1731-06O-20FM
-8	16.50	21.00	31.00	15°	19.90	2.65	54.03	29.50	95.80	41.90	20.00	1/8**	M18 X 1.5	G1731-08O-20FM
-10	20.50	22.00	35.00	15°	23.90	2.65	57.91	31.60	111.00	53.10	25.00	1/8**	M22 X 1.5	G1731-101-25FM
-12	25.00	27.00	41.00	15°	29.50	3.35	71.63	39.40	129.60	57.90	32.00	1/4**	M27 X 2	G1731-122-32FM
<b>m</b> -14	28.00	27.00	44.00	15°	32.50	3.35	71.63	39.70	129.60	57.90	32.00	1/4**	M30 X 2	G1731-142-32FM
-16	31.00	27.00	50.00	15°	35.50	3.35	71.63	38.10	129.60	57.90	32.00	1/4**	M33 X 2	G1731-162-32FM
-18	36.00	27.00	55.00	15°	40.50	3.35	81.46	46.80	146.80	65.50	32.00	1/4**	M38 X 2	G1731-183-32FM*
-20	40.00	27.00	61.00	15°	44.50	3.35	81.46	45.90	146.80	65.50	32.00	1/4**	M42 X 2	G1731-203-32FM*
-24	46.00	29.00	67.00	15°	50.50	3.35	81.46	42.80	146.80	65.50	32.00	1/4**	M48 X 2	G1731-243-32FM*
-32	58.00	32.00	77.00	15°	62.50	3.35	100.76	58.40	166.40	65.50	32.00	1/4**	M60 X 2	G1731-324-32FM*
C***	18.50	20.00	33.00	15°	21.90	2.65	54.36	32.50	107.40	53.10	25.00	1/8**	M20 X 1.5	G1731-CV1-25FM

\*NOTICE: Due to the cutting forces generated by this tool, a mechanical chuck is required. Please contact Application Engineering with any questions.

\*\* Metric thread to BSP and ISO 7-1

\*\*Cartridge cavity

A92: 30 - 37

A92: 2 - 4

A92: 28

Key on A92: 1

**i** = Imperial (in)  
**m** = Metric (mm)



JDS-G173.1

Inserts

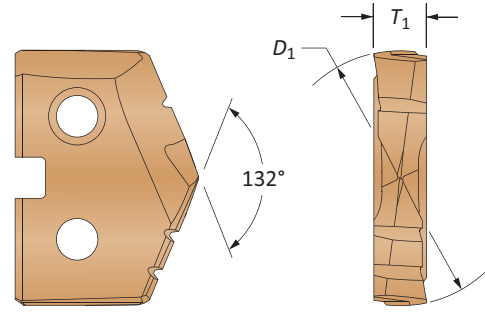

See section A3 for complete T-A insert details

GEN2 T-A® Drill Inserts

Tube Dash No.	AccuPort Part No.	T-A® Insert Series	Part No.		Insert Screw	Insert Driver	Admissible Tightening Torque**
			Super Cobalt (AM200)	Carbide (AM300®)			
-4	G1731-04Y-16FM	Y	45YH-10.5	4C2YP-10.5	724-IP7-1	8IP-7	7.4 in/lbs (84 N-cm)
-5	G1731-05Z-16FM	Z	45ZH-12.5	4C2ZP-12.5	7247-IP7-1	8IP-7	7.4 in/lbs (84 N-cm)
-6	G1731-060-20FM	0	450H-14.5	4C20P-14.5	72567-IP8-1	8IP-8	15.5 in/lbs (175 N-cm)
-8	G1731-080-20FM	0	450H-16.5	4C20P-16.5	72567-IP8-1	8IP-8	15.5 in/lbs (175 N-cm)
-10	G1731-101-25FM	1	451H-20.5	4C21P-20.5	739-IP9-1	8IP-9	27.0 in/lbs (305 N-cm)
-12	G1731-122-32FM	2	452H-25	4C22P-25	7495-IP15-1	8IP-15	61.0 in/lbs (690 N-cm)
-14	G1731-142-32FM	2	452H-28	4C22P-28	7495-IP15-1	8IP-15	61.0 in/lbs (690 N-cm)
-16	G1731-162-32FM	2	452H-31	4C22P-31	7495-IP15-1	8IP-15	61.0 in/lbs (690 N-cm)
-18	G1731-183-32FM*	3	453H-36	-	7514-IP20-1	8IP-20	121.3 in/lbs (1370 N-cm)
-20	G1731-203-32FM*	3	453H-40	-	7514-IP20-1	8IP-20	121.3 in/lbs (1370 N-cm)
-24	G1731-243-32FM*	3	453H-46	-	7514-IP20-1	8IP-20	121.3 in/lbs (1370 N-cm)
-32	G1731-324-32FM*	4	454H-58	-	7514-IP20-1	8IP-20	121.3 in/lbs (1370 N-cm)
C***	G1731-CV1-25FM	1	451H-18.5	4C21P-18.5	739-IP9-1	8IP-9	27.0 in/lbs (305 N-cm)

\*NOTICE: Due to the cutting forces generated by this tool, a mechanical chuck is required. Please contact Application Engineering with any questions.

\*\*Tightening torques are calculated with a friction coefficient of  $\mu = 0.14$  and develop 90% of ultimate yield strength

\*\*\*Cartridge cavity

Port Form Drill Inserts

Tube Dash No.	AccuPort Part No.	Part No.		Insert Screw	Insert Driver	Admissible Tightening Torque**
		C3 Carbide (AM200®)				
-4	G1731-04Y-16FM	G1731-01-C3H		72556-IP8-1	8IP-8	15.5 in/lbs (175 N-cm)
-5	G1731-05Z-16FM	G1731-01-C3H		72556-IP8-1	8IP-8	15.5 in/lbs (175 N-cm)
-6	G1731-060-20FM	G1731-02-C3H		72556-IP8-1	8IP-8	15.5 in/lbs (175 N-cm)
-8	G1731-080-20FM	G1731-02-C3H		72556-IP8-1	8IP-8	15.5 in/lbs (175 N-cm)
-10	G1731-101-25FM	G1731-02-C3H		72556-IP8-1	8IP-8	15.5 in/lbs (175 N-cm)
-12	G1731-122-32FM	G1731-03-C3H		72556-IP8-1	8IP-8	15.5 in/lbs (175 N-cm)
-14	G1731-142-32FM	G1731-03-C3H		72556-IP8-1	8IP-8	15.5 in/lbs (175 N-cm)
-16	G1731-162-32FM	G1731-04-C3H		7375-IP9-1	8IP-9	27.0 in/lbs (305 N-cm)
-18	G1731-183-32FM*	G1731-04-C3H		7375-IP9-1	8IP-9	27.0 in/lbs (305 N-cm)
-20	G1731-203-32FM*	G1731-05-C3H		7375-IP9-1	8IP-9	27.0 in/lbs (305 N-cm)
-24	G1731-243-32FM*	G1731-05-C3H		7375-IP9-1	8IP-9	27.0 in/lbs (305 N-cm)
-32	G1731-324-32FM*	G1731-06-C3H		7375-IP9-1	8IP-9	27.0 in/lbs (305 N-cm)
C***	G1731-CV1-25FM	G1731-02-C3H		72556-IP8-1	8IP-8	15.5 in/lbs (175 N-cm)

\*NOTICE: Due to the cutting forces generated by this tool, a mechanical chuck is required. Please contact Application Engineering with any questions.

\*\*Tightening torques are calculated with a friction coefficient of  $\mu = 0.14$  and develop 90% of ultimate yield strength

\*\*\*Cartridge cavity

A92: 30 - 37

A92: 2 - 4

A92: 28

Y - 2 series T-A inserts sold in multiples of 2  
 3 - 4 series T-A inserts sold in multiples of 1  
 Port form inserts sold in multiples of 2  
 Insert screws sold in multiples of 10

## Port and Thread Finishing Kits

J1926 | Imperial | Ferrous Materials

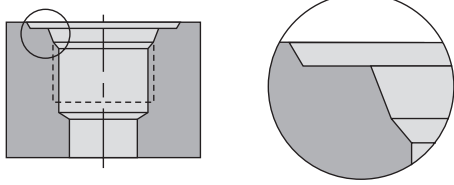

SAE J-1926-1 / ISO 11926-1

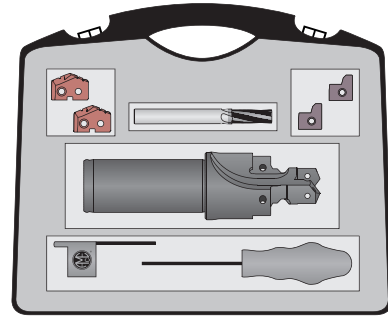

### Port and Thread Finishing Kits

Tube Dash No.	AccuPort 432			GEN2 T-A® Insert		Port Form Insert		AccuThread™ Thread Mill		Kit Part No.
	Part No.	Port Thread Size	Qty	Super Cobalt (AM200®)	Qty	C5 Carbide (TiAlN)	Qty	Part No. (AM210®)	Qty	
-4	J1926-04Y-063F	7/16-20 UNF-2B	1	45YH-.386	2	J1926-02-C5A	2	TMAK0438-20	1	ATKK04-1926
-5	J1926-05Z-063F	1/2-20 UNF-2B	1	45ZH-11.5	2	J1926-03-C5A	2	TMAK0438-20	1	ATKK05-1926
-6	J1926-060-075F	9/16-18 UNF-2B	1	450H-13	2	J1926-03-C5A	2	TMAK0563-18	1	ATKK06-1926
-8	J1926-080-075F	3/4-16 UNF-2B	1	450H-0022	2	J1926-07-C5A	2	TMAK0750-16	1	ATKK08-1926
-10	J1926-101-100F	7/8-14 UNF-2B	1	451H-20.5	2	J1926-04-C5A	2	TMAK0875-14	1	ATKK10-1926
-12	J1926-122-125F	1-1/16-12 UN-2B	1	452H-25	2	J1926-08-C5A	2	TMAK1063-12	1	ATKK12-1926
-14	J1926-142-125F	1-3/16-12 UN-2B	1	452H-28	2	J1926-08-C5A	2	TMAK1063-12	1	ATKK14-1926
-16	J1926-162-125F	1-5/16-12 UN-2B	1	452H-1.231	2	J1926-09-C5A	2	TMAK1063-12	1	ATKK16-1926
-20	J1926-203-150F	1-5/8-12 UN-2B	1	453H-39	1	J1926-10-C5A	2	TMAK1063-12	1	ATKK20-1926
-24	J1926-243-150F	1-7/8-12 UN-2B	1	453H-45.5	1	J1926-11-C5A	2	TMAK1063-12	1	ATKK24-1926
-32	J1926-324-150F	2-1/2-12 UN-2B	1	454H-61.5	1	J1926-12-C5A	2	TMAK1063-12	1	ATKK32-1926

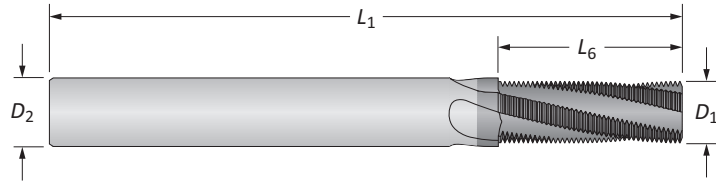

### AccuThread™ Port Specific Solid Carbide Thread Mills

Port Size	Pitch	Thread Mill				Flutes	Part No.
		D <sub>1</sub>	L <sub>6</sub>	D <sub>2</sub>	L <sub>1</sub>		
-4 to -5	20	0.335	0.600	0.375	3.5	4	TMAK0438-20
-6	18	0.370	0.666	0.375	3.5	4	TMAK0563-18
-8	16	0.495	0.750	0.500	3.5	4	TMAK0750-16
-10	14	0.495	0.857	0.500	3.5	4	TMAK0875-14
-12 to -32	12	0.495	0.917	0.500	3.5	4	TMAK1063-12

AccuPort 432 specific thread mills - International Unified Series (UN) manufactured specifically for use with AccuPort 432 hydraulic port forms. The length of cut allows full thread with one pass. Conforms with J1926 and SAE AS5202 port form specifications.

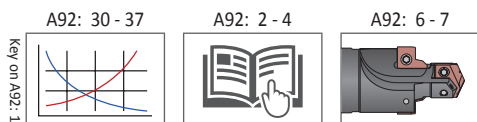



## Port and Thread Finishing Kits

J1926 | Imperial | Non-Ferrous Materials

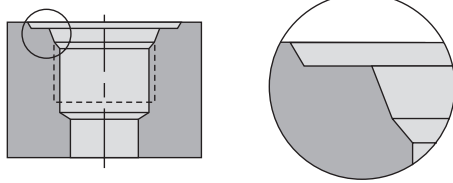

SAE J-1926-1 / ISO 11926-1

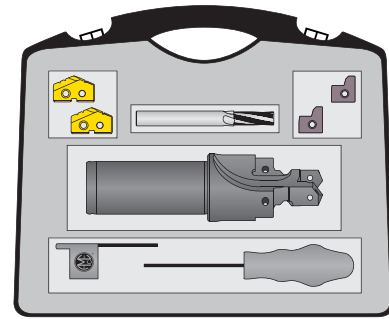

### Port and Thread Finishing Kits

Tube Dash No.	AccuPort 432			Original T-A® Insert		Port Form Insert		AccuThread™ Thread Mill		Kit Part No.
	Part No.	Port Thread Size	Qty	Super Cobalt (TiN)	Qty	C5 Carbide (TiAlN)	Qty	Part No. (Uncoated)	Qty	
-4	J1926-04Y-063F	7/16-20 UNF-2B	1	15YT-386	2	J1926-02-C5A	2	TMAU0438-20	1	ATKU04-1926
-5	J1926-05Z-063F	1/2-20 UNF-2B	1	15ZT-11.5	2	J1926-03-C5A	2	TMAU0438-20	1	ATKU05-1926
-6	J1926-060-075F	9/16-18 UNF-2B	1	150T-13	2	J1926-03-C5A	2	TMAU0563-18	1	ATKU06-1926
-8	J1926-080-075F	3/4-16 UNF-2B	1	150T-0022	2	J1926-07-C5A	2	TMAU0750-16	1	ATKU08-1926
-10	J1926-101-100F	7/8-14 UNF-2B	1	151T-20.5	2	J1926-04-C5A	2	TMAU0875-14	1	ATKU10-1926
-12	J1926-122-125F	1-1/16-12 UN-2B	1	152T-25	2	J1926-08-C5A	2	TMAU1063-12	1	ATKU12-1926
-14	J1926-142-125F	1-3/16-12 UN-2B	1	152T-28	2	J1926-08-C5A	2	TMAU1063-12	1	ATKU14-1926
-16	J1926-162-125F	1-5/16-12 UN-2B	1	152T-1.231	2	J1926-09-C5A	2	TMAU1063-12	1	ATKU16-1926
-20	J1926-203-150F	1-5/8-12 UN-2B	1	453T-39	1	J1926-10-C5A	2	TMAU1063-12	1	ATKU20-1926
-24	J1926-243-150F	1-7/8-12 UN-2B	1	453T-45.5	1	J1926-11-C5A	2	TMAU1063-12	1	ATKU24-1926
-32	J1926-324-150F	2-1/2-12 UN-2B	1	454T-61.5	1	J1926-12-C5A	2	TMAU1063-12	1	ATKU32-1926

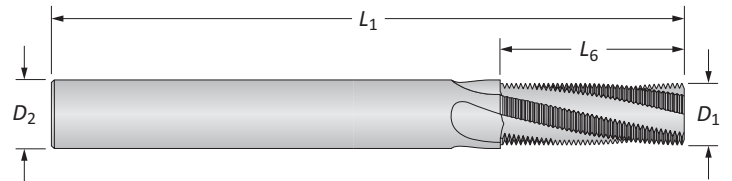

### AccuThread™ Port Specific Solid Carbide Thread Mills

Port Size	Pitch	Thread Mill				Flutes	Part No.
		D <sub>1</sub>	L <sub>6</sub>	D <sub>2</sub>	L <sub>1</sub>		
-4 to -5	20	0.335	0.600	0.375	3.5	4	TMAU0438-20
-6	18	0.370	0.666	0.375	3.5	4	TMAU0563-18
-8	16	0.495	0.750	0.500	3.5	4	TMAU0750-16
-10	14	0.495	0.857	0.500	3.5	4	TMAU0875-14
-12 to -32	12	0.495	0.917	0.500	3.5	4	TMAU1063-12

AccuPort 432 specific thread mills - International Unified Series (UN) manufactured specifically for use with AccuPort 432 hydraulic port forms. The length of cut allows full thread with one pass. Conforms with J1926 and SAE A5202 port form specifications.

Key on A92-1

A92: 30 - 37

A92: 2 - 4

A92: 6 - 7

J  
 A DRILLING  
 B BORING  
 C REAMING  
 D BURNISHING  
 E THREADING  
 X SPECIALS

## Port and Thread Finishing Kits

J1926 | Metric | Ferrous Materials

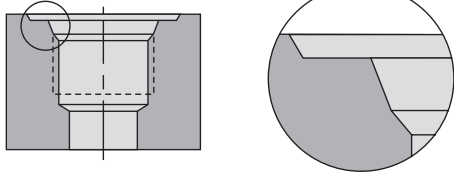

SAE J-1926-1 / ISO 11926-1

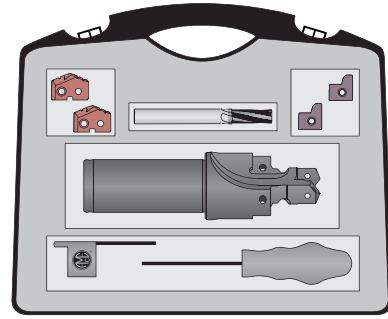

### Port and Thread Finishing Kits

Tube Dash No.	AccuPort 432			GEN2 T-A® Insert		Port Form Insert		AccuThread™ Thread Mill		Kit Part No.
	Part No.	Port Thread Size	Qty	Super Cobalt (AM200®)	Qty	C5 Carbide (TiAlN)	Qty	Part No. (AM210®)	Qty	
-4	J1926-04Y-16FM	7/16-20 UNF-2B	1	45YH-.386	2	J1926-02-C5A	2	TMAK0438-20M	1	ATKK04-1926M
-5	J1926-05Z-16FM	1/2-20 UNF-2B	1	45ZH-11.5	2	J1926-03-C5A	2	TMAK0438-20M	1	ATKK05-1926M
-6	J1926-060-20FM	9/16-18 UNF-2B	1	450H-13	2	J1926-03-C5A	2	TMAK0563-18M	1	ATKK06-1926M
-8	J1926-080-20FM	3/4-16 UNF-2B	1	450H-0022	2	J1926-07-C5A	2	TMAK0750-16M	1	ATKK08-1926M
-10	J1926-101-25FM	7/8-14 UNF-2B	1	451H-20.5	2	J1926-04-C5A	2	TMAK0875-14M	1	ATKK10-1926M
-12	J1926-122-32FM	1-1/16-12 UN-2B	1	452H-25	2	J1926-08-C5A	2	TMAK1063-12M	1	ATKK12-1926M
-14	J1926-142-32FM	1-3/16-12 UN-2B	1	452H-28	2	J1926-08-C5A	2	TMAK1063-12M	1	ATKK14-1926M
-16	J1926-162-32FM	1-5/16-12 UN-2B	1	452H-1.231	2	J1926-09-C5A	2	TMAK1063-12M	1	ATKK16-1926M
-20	J1926-203-32FM	1-5/8-12 UN-2B	1	453H-39	1	J1926-10-C5A	2	TMAK1063-12M	1	ATKK20-1926M
-24	J1926-243-32FM	1-7/8-12 UN-2B	1	453H-45.5	1	J1926-11-C5A	2	TMAK1063-12M	1	ATKK24-1926M
-32	J1926-324-32FM	2-1/2-12 UN-2B	1	454H-61.5	1	J1926-12-C5A	2	TMAK1063-12M	1	ATKK32-1926M

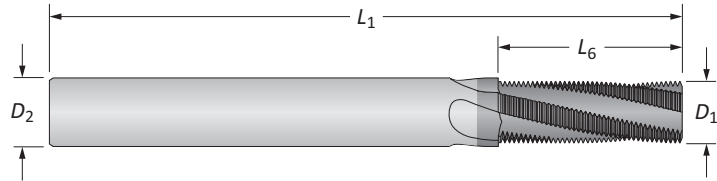

### AccuThread™ Port Specific Solid Carbide Thread Mills

Port Size	Pitch	Thread Mill				Flutes	Part No.
		D <sub>1</sub>	L <sub>6</sub>	D <sub>2</sub>	L <sub>1</sub>		
-4 to -5	20	8.51	15.24	10.00	73.00	4	TMAK0438-20M
-6	18	9.40	16.92	10.00	73.00	4	TMAK0563-18M
-8	16	11.94	19.05	12.00	84.00	4	TMAK0750-16M
-10	14	11.94	21.77	12.00	84.00	4	TMAK0875-14M
-12 to -32	12	11.94	23.29	12.00	84.00	4	TMAK1063-12M

AccuPort 432 specific thread mills - International Unified Series (UN) manufactured specifically for use with AccuPort 432 hydraulic port forms. The length of cut allows full thread with one pass. Conforms with J1926 and SAE AS5202 port form specifications.

A92: 30 - 37      A92: 2 - 4      A92: 8 - 9

Key on A92: 1

A DRILLING

B BORING

C REAMING

D BURNISHING

F THREADING

X SPECIALS



## Port and Thread Finishing Kits

J1926 | Metric | Non-Ferrous Materials

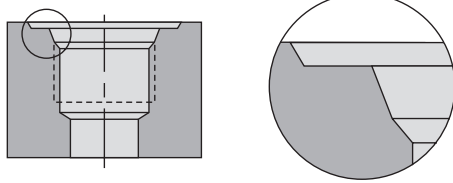

SAE J-1926-1 / ISO 11926-1

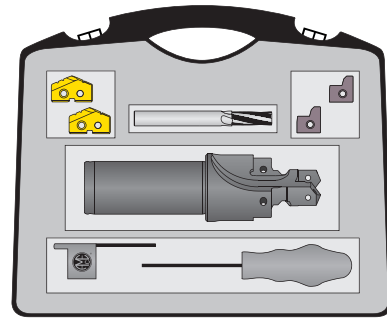

### Port and Thread Finishing Kits

Tube Dash No.	AccuPort 432			Original T-A® Insert		Port Form Insert		AccuThread™ Thread Mill		Kit Part No.
	Part No.	Port Thread Size	Qty	Super Cobalt (TiN)	Qty	C5 Carbide (TiAlN)	Qty	Part No. (Uncoated)	Qty	
-4	J1926-04Y-16FM	7/16-20 UNF-2B	1	15YT-386	2	J1926-02-C5A	2	TMAU0438-20M	1	ATKU04-1926M
-5	J1926-05Z-16FM	1/2-20 UNF-2B	1	15ZT-11.5	2	J1926-03-C5A	2	TMAU0438-20M	1	ATKU05-1926M
-6	J1926-060-20FM	9/16-18 UNF-2B	1	150T-13	2	J1926-03-C5A	2	TMAU0563-18M	1	ATKU06-1926M
-8	J1926-080-20FM	3/4-16 UNF-2B	1	150T-0022	2	J1926-07-C5A	2	TMAU0750-16M	1	ATKU08-1926M
-10	J1926-101-25FM	7/8-14 UNF-2B	1	151T-20.5	2	J1926-04-C5A	2	TMAU0875-14M	1	ATKU10-1926M
-12	J1926-122-32FM	1-1/16-12 UN-2B	1	152T-25	2	J1926-08-C5A	2	TMAU1063-12M	1	ATKU12-1926M
-14	J1926-142-32FM	1-3/16-12 UN-2B	1	152T-28	2	J1926-08-C5A	2	TMAU1063-12M	1	ATKU14-1926M
-16	J1926-162-32FM	1-5/16-12 UN-2B	1	152T-1.231	2	J1926-09-C5A	2	TMAU1063-12M	1	ATKU16-1926M
-20	J1926-203-32FM	1-5/8-12 UN-2B	1	453T-39	1	J1926-10-C5A	2	TMAU1063-12M	1	ATKU20-1926M
-24	J1926-243-32FM	1-7/8-12 UN-2B	1	453T-45.5	1	J1926-11-C5A	2	TMAU1063-12M	1	ATKU24-1926M
-32	J1926-324-32FM	2-1/2-12 UN-2B	1	454T-61.5	1	J1926-12-C5A	2	TMAU1063-12M	1	ATKU32-1926M

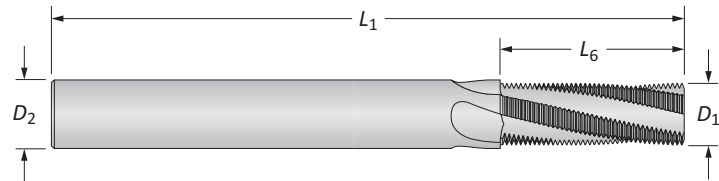

### AccuThread™ Port Specific Solid Carbide Thread Mills

Port Size	Pitch	Thread Mill				Flutes	Part No.
		D <sub>1</sub>	L <sub>6</sub>	D <sub>2</sub>	L <sub>1</sub>		
-4 to -5	20	8.51	15.24	10.00	73.00	4	TMAU0438-20M
-6	18	9.40	16.92	10.00	73.00	4	TMAU0563-18M
-8	16	11.94	19.05	12.00	84.00	4	TMAU0750-16M
-10	14	11.94	21.77	12.00	84.00	4	TMAU0875-14M
-12 to -32	12	11.94	23.29	12.00	84.00	4	TMAU1063-12M

AccuPort 432 specific thread mills - International Unified Series (UN) manufactured specifically for use with AccuPort 432 hydraulic port forms. The length of cut allows full thread with one pass. Conforms with J1926 and SAE A5202 port form specifications.

Key on A92-1

A92: 30 - 37

A92: 2 - 4

A92: 8 - 9

J  
 A DRILLING  
 B BORING  
 C REAMING  
 D BURNISHING  
 E THREADING  
 X SPECIALS

## Port and Thread Finishing Kits

I6149 | No ID Ridge | Ferrous Materials

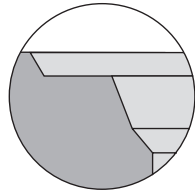
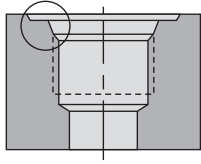

ISO 6149-1:2006 / SAE J-2244/1

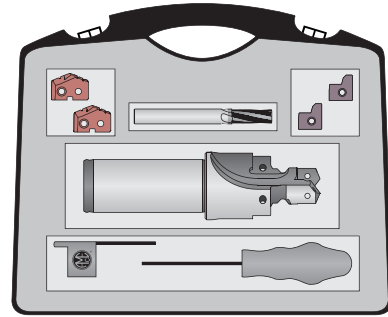

### Port and Thread Finishing Kits

Tube Dash No.	AccuPort 432			GEN2 T-A® Insert		Port Form Insert		AccuThread™ Thread Mill		Kit Part No.
	Part No.	Port Thread Size	Qty	Super Cobalt (AM200®)	Qty	C5 Carbide (TiAlN)	Qty	Part No. (AM210®)	Qty	
-4	I6149-04RY-16FM	M12 X 1.5	1	45YH-10.5	2	I6149-04-C5A	2	TMMK1000-150M	1	ATKK04-6149
-5	I6149-05RZ-16FM	M14 X 1.5	1	45ZH-12.5	2	I6149-04-C5A	2	TMMK1400-150M	1	ATKK05-6149
-6	I6149-06RO-20FM	M16 X 1.5	1	45OH-14.5	2	I6149-06-C5A	2	TMMK1400-150M	1	ATKK06-6149
-8	I6149-08RO-20FM	M18 X 1.5	1	45OH-16.5	2	I6149-06-C5A	2	TMMK1800-150M	1	ATKK08-6149
-10	I6149-10R1-25FM	M22 X 1.5	1	451H-20.5	2	I6149-04-C5A	2	TMMK1800-150M	1	ATKK10-6149
-12	I6149-12R2-32FM	M27 X 2	1	452H-25	2	I6149-12-C5A	2	TMMK2000-200M	1	ATKK12-6149
-14	I6149-14R2-32FM	M30 X 2	1	452H-28	2	I6149-14-C5A	2	TMMK2000-200M	1	ATKK14-6149
-16	I6149-16R2-32FM	M33 X 2	1	452H-31	2	I6149-16-C5A	2	TMMK2000-200M	1	ATKK16-6149
-20	I6149-20R3-32FM	M42 X 2	1	453H-40	1	I6149-20-C5A	2	TMMK2000-200M	1	ATKK20-6149
-24	I6149-24R3-32FM	M48 X 2	1	453H-46	1	I6149-24-C5A	2	TMMK2000-200M	1	ATKK24-6149
-32	I6149-32R4-32FM	M60 X 2	1	454H-58	1	I6149-32-C5A	2	TMMK2000-200M	1	ATKK32-6149

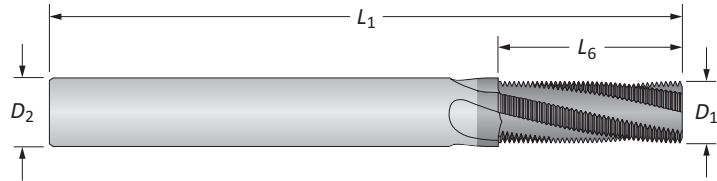

### AccuThread™ Port Specific Solid Carbide Thread Mills

Port Size	Pitch	Thread Mill				Flutes	Part No.
		$D_1$	$L_6$	$D_2$	$L_1$		
-4	1.50	7.40	19.50	8.00	64.00	4	TMMK1000-150M
-5 to -6	1.50	10.90	27.00	12.00	84.00	4	TMMK1400-150M
-8 to -10	1.50	11.90	31.50	12.00	84.00	4	TMMK1800-150M
-12 to -32	2.00	11.95	30.00	12.00	84.00	4	TMMK2000-200M

AccuPort 432 specific thread mills - International Unified Series (UN) manufactured specifically for use with AccuPort 432 hydraulic port forms. The length of cut allows full thread with one pass. Conforms with J1926 and SAE AS5202 port form specifications.

A92: 30 - 37      A92: 2 - 4      A92: 12 - 13

Key on A92: 1





## Port and Thread Finishing Kits

I6149 | No ID Ridge | Non-Ferrous Materials

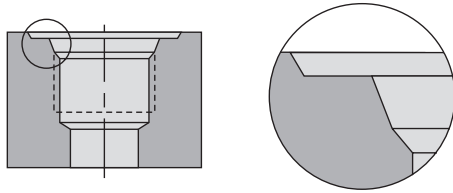

ISO 6149-1:2006 / SAE J-2244/1

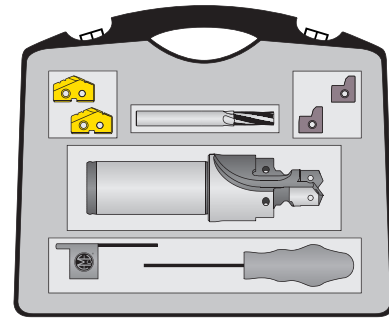

### Port and Thread Finishing Kits

Tube Dash No.	AccuPort 432			Original T-A® Insert		Port Form Insert		AccuThread™ Thread Mill		Kit Part No.
	Part No.	Port Thread Size	Qty	Super Cobalt (TiN)	Qty	C5 Carbide (TiAlN)	Qty	Part No. (Uncoated)	Qty	
-4	I6149-04RY-16FM	M12 X 1.5	1	15YT-10.5	2	I6149-04-C5A	2	TMMU1000-150M	1	ATKU04-6149
-5	I6149-05RZ-16FM	M14 X 1.5	1	15ZT-12.5	2	I6149-04-C5A	2	TMMU1400-150M	1	ATKU05-6149
-6	I6149-06RO-20FM	M16 X 1.5	1	150T-14.5	2	I6149-06-C5A	2	TMMU1400-150M	1	ATKU06-6149
-8	I6149-08RO-20FM	M18 X 1.5	1	150T-16.5	2	I6149-06-C5A	2	TMMU1800-150M	1	ATKU08-6149
-10	I6149-10R1-25FM	M22 X 1.5	1	151T-20.5	2	I6149-04-C5A	2	TMMU1800-150M	1	ATKU10-6149
-12	I6149-12R2-32FM	M27 X 2	1	152T-25	2	I6149-12-C5A	2	TMMU2000-200M	1	ATKU12-6149
-14	I6149-14R2-32FM	M30 X 2	1	152T-28	2	I6149-14-C5A	2	TMMU2000-200M	1	ATKU14-6149
-16	I6149-16R2-32FM	M33 X 2	1	152T-31	2	I6149-16-C5A	2	TMMU2000-200M	1	ATKU16-6149
-20	I6149-20R3-32FM	M42 X 2	1	453T-40	1	I6149-20-C5A	2	TMMU2000-200M	1	ATKU20-6149
-24	I6149-24R3-32FM	M48 X 2	1	453T-46	1	I6149-24-C5A	2	TMMU2000-200M	1	ATKU24-6149
-32	I6149-32R4-32FM	M60 X 2	1	454T-58	1	I6149-32-C5A	2	TMMU2000-200M	1	ATKU32-6149

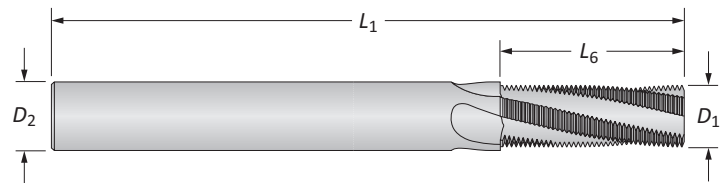

### AccuThread™ Port Specific Solid Carbide Thread Mills

Port Size	Pitch	Thread Mill				Flutes	Part No.
		D <sub>1</sub>	L <sub>6</sub>	D <sub>2</sub>	L <sub>1</sub>		
-4	1.50	7.40	19.50	8.00	64.00	4	TMMU1000-150M
-5 to -6	1.50	10.90	27.00	12.00	84.00	4	TMMU1400-150M
-8 to -10	1.50	11.90	31.50	12.00	84.00	4	TMMU1800-150M
-12 to -32	2.00	11.95	30.00	12.00	84.00	4	TMMU2000-200M

AccuPort 432 specific thread mills - International Unified Series (UN) manufactured specifically for use with AccuPort 432 hydraulic port forms. The length of cut allows full thread with one pass. Conforms with J1926 and SAE A5202 port form specifications.

Key on A92: 1

A92: 30 - 37

A92: 2 - 4

A92: 12 - 13

## Port and Thread Finishing Kits

I6149 | ID Ridge | Ferrous Materials

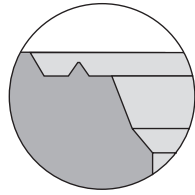
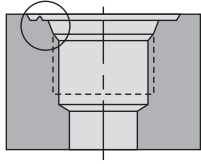

ISO 6149-1:2006 / SAE J-2244/1

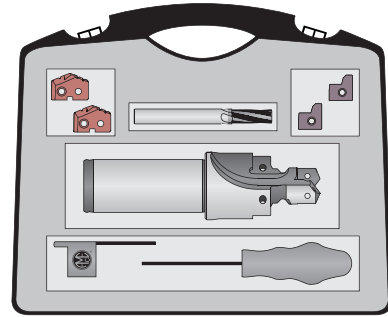

### Port and Thread Finishing Kits

Tube Dash No.	AccuPort 432			GEN2 T-A® Insert		Port Form Insert		AccuThread™ Thread Mill		Kit Part No.
	Part No.	Port Thread Size	Qty	Super Cobalt (AM200®)	Qty	C5 Carbide (TiAlN)	Qty	Part No. (AM210®)	Qty	
-4	I6149-04RY-16FM	M12 X 1.5	1	45YH-10.5	2	I6149-04R-C5A	2	TMMK1000-150M	1	ATKK04R-6149
-5	I6149-05RZ-16FM	M14 X 1.5	1	45ZH-12.5	2	I6149-04R-C5A	2	TMMK1400-150M	1	ATKK05R-6149
-6	I6149-06R0-20FM	M16 X 1.5	1	450H-14.5	2	I6149-06R-C5A	2	TMMK1400-150M	1	ATKK06R-6149
-8	I6149-08R0-20FM	M18 X 1.5	1	450H-16.5	2	I6149-06R-C5A	2	TMMK1800-150M	1	ATKK08R-6149
-10	I6149-10R1-25FM	M22 X 1.5	1	451H-20.5	2	I6149-04R-C5A	2	TMMK1800-150M	1	ATKK10R-6149
-12	I6149-12R2-32FM	M27 X 2	1	452H-25	2	I6149-12R-C5A	2	TMMK2000-200M	1	ATKK12R-6149
-14	I6149-14R2-32FM	M30 X 2	1	452H-28	2	I6149-14R-C5A	2	TMMK2000-200M	1	ATKK14R-6149
-16	I6149-16R2-32FM	M33 X 2	1	452H-31	2	I6149-16R-C5A	2	TMMK2000-200M	1	ATKK16R-6149
-20	I6149-20R3-32FM	M42 X 2	1	453H-40	1	I6149-20R-C5A	2	TMMK2000-200M	1	ATKK20R-6149
-24	I6149-24R3-32FM	M48 X 2	1	453H-46	1	I6149-24R-C5A	2	TMMK2000-200M	1	ATKK24R-6149
-32	I6149-32R4-32FM	M60 X 2	1	454H-58	1	I6149-32R-C5A	2	TMMK2000-200M	1	ATKK32R-6149

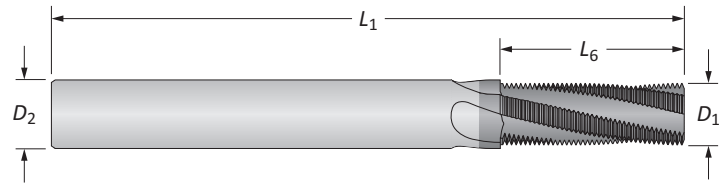

### AccuThread™ Port Specific Solid Carbide Thread Mills

Port Size	Pitch	Thread Mill				Flutes	Part No.
		$D_1$	$L_6$	$D_2$	$L_1$		
-4	1.50	7.40	19.50	8.00	64.00	4	TMMK1000-150M
-5 to -6	1.50	10.90	27.00	12.00	84.00	4	TMMK1400-150M
-8 to -10	1.50	11.90	31.50	12.00	84.00	4	TMMK1800-150M
-12 to -32	2.00	11.95	30.00	12.00	84.00	4	TMMK2000-200M

AccuPort 432 specific thread mills - International Unified Series (UN) manufactured specifically for use with AccuPort 432 hydraulic port forms. The length of cut allows full thread with one pass. Conforms with J1926 and SAE AS5202 port form specifications.

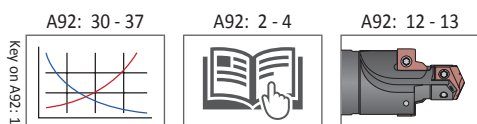



## Port and Thread Finishing Kits

I6149 | ID Ridge | Non-Ferrous Materials

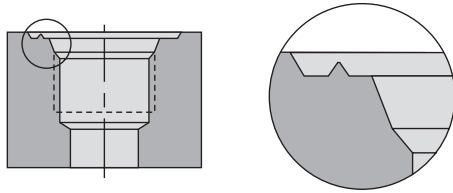

ISO 6149-1:2006 / SAE J-2244/1

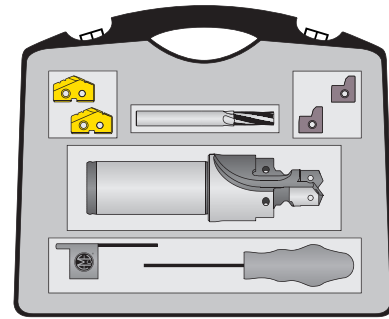

### Port and Thread Finishing Kits

Tube Dash No.	AccuPort 432			Original T-A® Insert		Port Form Insert		AccuThread™ Thread Mill		Kit Part No.
	Part No.	Port Thread Size	Qty	Super Cobalt (TiN)	Qty	C5 Carbide (TiAlN)	Qty	Part No. (Uncoated)	Qty	
-4	I6149-04RY-16FM	M12 X 1.5	1	15YT-10.5	2	I6149-04R-C5A	2	TMMU1000-150M	1	ATKU04R-6149
-5	I6149-05RZ-16FM	M14 X 1.5	1	15ZT-12.5	2	I6149-04R-C5A	2	TMMU1400-150M	1	ATKU05R-6149
-6	I6149-06RO-20FM	M16 X 1.5	1	15OT-14.5	2	I6149-06R-C5A	2	TMMU1400-150M	1	ATKU06R-6149
-8	I6149-08RO-20FM	M18 X 1.5	1	15OT-16.5	2	I6149-06R-C5A	2	TMMU1800-150M	1	ATKU08R-6149
-10	I6149-10R1-25FM	M22 X 1.5	1	151T-20.5	2	I6149-04R-C5A	2	TMMU1800-150M	1	ATKU10R-6149
-12	I6149-12R2-32FM	M27 X 2	1	152T-25	2	I6149-12R-C5A	2	TMMU2000-200M	1	ATKU12R-6149
-14	I6149-14R2-32FM	M30 X 2	1	152T-28	2	I6149-14R-C5A	2	TMMU2000-200M	1	ATKU14R-6149
-16	I6149-16R2-32FM	M33 X 2	1	152T-31	2	I6149-16R-C5A	2	TMMU2000-200M	1	ATKU16R-6149
-20	I6149-20R3-32FM	M42 X 2	1	453T-40	1	I6149-20R-C5A	2	TMMU2000-200M	1	ATKU20R-6149
-24	I6149-24R3-32FM	M48 X 2	1	453T-46	1	I6149-24R-C5A	2	TMMU2000-200M	1	ATKU24R-6149
-32	I6149-32R4-32FM	M60 X 2	1	454T-58	1	I6149-32R-C5A	2	TMMU2000-200M	1	ATKU32R-6149

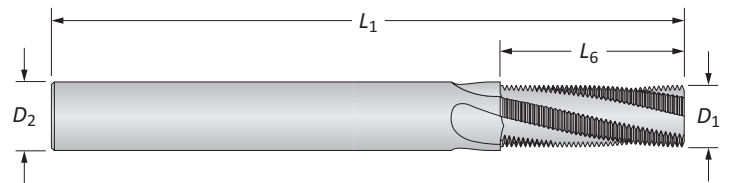

### AccuThread™ Port Specific Solid Carbide Thread Mills

Port Size	Pitch	Thread Mill				Flutes	Part No.
		D <sub>1</sub>	L <sub>6</sub>	D <sub>2</sub>	L <sub>1</sub>		
-4	1.50	7.40	19.50	8.00	64.00	4	TMMU1000-150M
-5 to -6	1.50	10.90	27.00	12.00	84.00	4	TMMU1400-150M
-8 to -10	1.50	11.90	31.50	12.00	84.00	4	TMMU1800-150M
-12 to -32	2.00	11.95	30.00	12.00	84.00	4	TMMU2000-200M

AccuPort 432 specific thread mills - International Unified Series (UN) manufactured specifically for use with AccuPort 432 hydraulic port forms. The length of cut allows full thread with one pass. Conforms with J1926 and SAE A5202 port form specifications.

Key on A92: 1

A92: 30 - 37

A92: 2 - 4

A92: 12 - 13

I DRILLING  
 B BORING  
 C REAMING  
 D BURNISHING  
 E THREADING  
 X SPECIALS

## Port and Thread Finishing Kits

AS5202 | Ferrous Materials

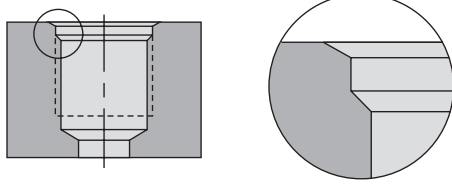

SAE AS5202

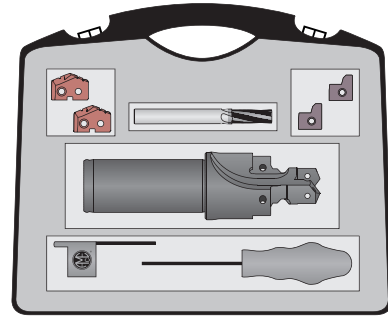

### Port and Thread Finishing Kits

Tube Dash No.	AccuPort 432			GEN2 T-A® Insert		Port Form Insert		AccuThread™ Thread Mill		Kit Part No.
	Part No.	Port Thread Size	Qty	Super Cobalt (AM200®)	Qty	C5 Carbide (TiAlN)	Qty	Part No. (AM210®)	Qty	
-4	AS5202-04Y-063F	7/16-20 UNJF-3B	1	45YH-.390	2	AS5202-04-C5A	2	TMAK0438-20	1	ATKK04-5202
-5	AS5202-05Z-063F	1/2-20 UNJF-3B	1	45ZH-11.5	2	AS5202-05-C5A	2	TMAK0438-20	1	ATKK05-5202
-6	AS5202-06Z-075F	9/16-18 UNJF-3B	1	45ZH-.510	2	AS5202-06-C5A	2	TMAK0563-18	1	ATKK06-5202
-8	AS5202-080-075F	3/4-16 UNJF-3B	1	450H-17.5	2	AS5202-08-C5A	2	TMAK0750-16	1	ATKK08-5202
-10	AS5202-101-100F	7/8-14 UNJF-3B	1	451H-20.5	2	AS5202-10-C5A	2	TMAK0875-14	1	ATKK10-5202
-12	AS5202-122-125F	1-1/16-12 UNJ-3B	1	452H-25	2	AS5202-12-C5A	2	TMAK1063-12	1	ATKK12-5202
-14	AS5202-142-125F	1-3/16-12 UNJ-3B	1	452H-1.109	2	AS5202-14-C5A	2	TMAK1063-12	1	ATKK14-5202
-16	AS5202-162-125F	1-5/16-12 UNJ-3B	1	452H-1.234	2	AS5202-16-C5A	2	TMAK1063-12	1	ATKK16-5202
-20	AS5202-203-150F	1-5/8-12 UNJ-3B	1	453H-1.547	1	AS5202-20-C5A	2	TMAK1063-12	1	ATKK20-5202
-24	AS5202-243-150F	1-7/8-12 UNJ-3B	1	453H-1.797	1	AS5202-24-C5A	2	TMAK1063-12	1	ATKK24-5202
-32	AS5202-324-150F	2-1/2-12 UNJ-3B	1	454H-61.5	1	AS5202-32-C5A	2	TMAK1063-12	1	ATKK32-5202

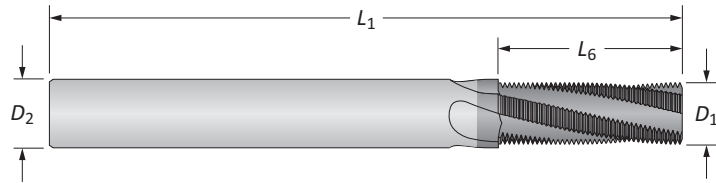

### AccuThread™ Port Specific Solid Carbide Thread Mills

Port Size	Pitch	Thread Mill				Flutes	Part No.
		D <sub>1</sub>	L <sub>6</sub>	D <sub>2</sub>	L <sub>1</sub>		
-4 to -5	20	0.335	0.600	0.375	3.5	4	TMAK0438-20
-6	18	0.370	0.666	0.375	3.5	4	TMAK0563-18
-8	16	0.495	0.750	0.500	3.5	4	TMAK0750-16
-10	14	0.495	0.857	0.500	3.5	4	TMAK0875-14
-12 to -32	12	0.495	0.917	0.500	3.5	4	TMAK1063-12

AccuPort 432 specific thread mills - International Unified Series (UN) manufactured specifically for use with AccuPort 432 hydraulic port forms. The length of cut allows full thread with one pass. Conforms with J1926 and SAE AS5202 port form specifications.

A92: 30 - 37      A92: 2 - 4      A92: 14 - 15



## Port and Thread Finishing Kits

AS5202 | Non-Ferrous Materials

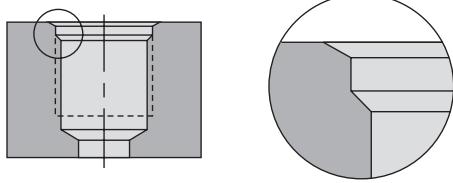

SAE AS5202

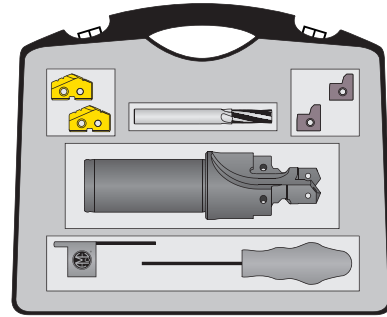

### Port and Thread Finishing Kits

Tube Dash No.	AccuPort 432			Original T-A® Insert		Port Form Insert		AccuThread™ Thread Mill		Kit Part No.
	Part No.	Port Thread Size	Qty	Super Cobalt (TiN)	Qty	C5 Carbide (TiAlN)	Qty	Part No. (Uncoated)	Qty	
-4	AS5202-04Y-063F	7/16-20 UNJF-3B	1	15YT-.390	2	AS5202-04-C5A	2	TMAU0438-20	1	ATKU04-5202
-5	AS5202-05Z-063F	1/2-20 UNJF-3B	1	15ZT-11.5	2	AS5202-05-C5A	2	TMAU0438-20	1	ATKU05-5202
-6	AS5202-06Z-075F	9/16-18 UNJF-3B	1	15ZT-.510	2	AS5202-06-C5A	2	TMAU0563-18	1	ATKU06-5202
-8	AS5202-080-075F	3/4-16 UNJF-3B	1	150T-17.5	2	AS5202-08-C5A	2	TMAU0750-16	1	ATKU08-5202
-10	AS5202-101-100F	7/8-14 UNJF-3B	1	151T-20.5	2	AS5202-10-C5A	2	TMAU0875-14	1	ATKU10-5202
-12	AS5202-122-125F	1-1/16-12 UNJ-3B	1	152T-25	2	AS5202-12-C5A	2	TMAU1063-12	1	ATKU12-5202
-14	AS5202-142-125F	1-3/16-12 UNJ-3B	1	152T-1.109	2	AS5202-14-C5A	2	TMAU1063-12	1	ATKU14-5202
-16	AS5202-162-125F	1-5/16-12 UNJ-3B	1	152T-1.234	2	AS5202-16-C5A	2	TMAU1063-12	1	ATKU16-5202
-20	AS5202-203-150F	1-5/8-12 UNJ-3B	1	453T-1.547	1	AS5202-20-C5A	2	TMAU1063-12	1	ATKU20-5202
-24	AS5202-243-150F	1-7/8-12 UNJ-3B	1	453T-1.797	1	AS5202-24-C5A	2	TMAU1063-12	1	ATKU24-5202
-32	AS5202-324-150F	2-1/2-12 UNJ-3B	1	454T-61.5	1	AS5202-32-C5A	2	TMAU1063-12	1	ATKU32-5202

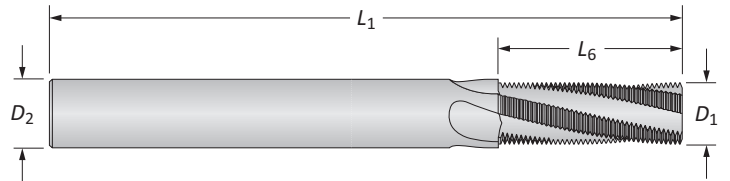

### AccuThread™ Port Specific Solid Carbide Thread Mills

Port Size	Pitch	Thread Mill				Flutes	Part No.
		D <sub>1</sub>	L <sub>6</sub>	D <sub>2</sub>	L <sub>1</sub>		
-4 to -5	20	0.335	0.600	0.375	3.5	4	TMAU0438-20
-6	18	0.370	0.666	0.375	3.5	4	TMAU0563-18
-8	16	0.495	0.750	0.500	3.5	4	TMAU0750-16
-10	14	0.495	0.857	0.500	3.5	4	TMAU0875-14
-12 to -32	12	0.495	0.917	0.500	3.5	4	TMAU1063-12

AccuPort 432 specific thread mills - International Unified Series (UN) manufactured specifically for use with AccuPort 432 hydraulic port forms. The length of cut allows full thread with one pass. Conforms with J1926 and SAE AS5202 port form specifications.

A92: 30 - 37

A92: 2 - 4

A92: 14 - 15

Key on A92: 1

## Port and Thread Finishing Kits

G1731 | Ferrous Materials

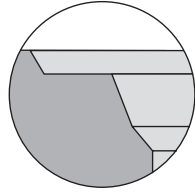
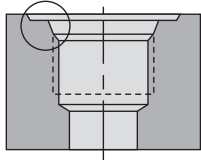

JDS-G173.1

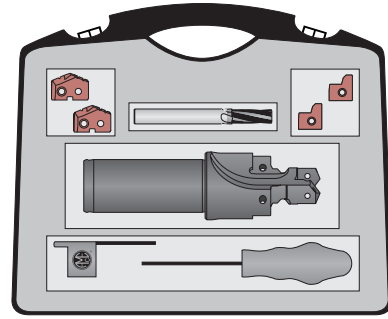

### Port and Thread Finishing Kits

Tube Dash No.	AccuPort 432			GEN2 T-A® Insert		Port Form Insert		AccuThread™ Thread Mill		Kit Part No.
	Part No.	Port Thread Size	Qty	Super Cobalt (AM200®)	Qty	C3 Carbide (AM200®)	Qty	Part No. (AM210®)	Qty	
-4	G1731-04Y-16FM	M12 X 1.5	1	45YH-10.5	2	G1731-01-C3H	2	TMMK1000-150M	1	ATKK04-G1731
-5	G1731-05Z-16FM	M14 X 1.5	1	45ZH-12.5	2	G1731-01-C3H	2	TMMK1400-150M	1	ATKK05-G1731
-6	G1731-06O-20FM	M16 X 1.5	1	45OH-14.5	2	G1731-02-C3H	2	TMMK1400-150M	1	ATKK06-G1731
-8	G1731-08O-20FM	M18 X 1.5	1	45OH-16.5	2	G1731-02-C3H	2	TMMK1800-150M	1	ATKK08-G1731
-10	G1731-10I-25FM	M22 X 1.5	1	45IH-20.5	2	G1731-02-C3H	2	TMMK1800-150M	1	ATKK10-G1731
-12	G1731-12Z-32FM	M27 X 2	1	45ZH-25	2	G1731-03-C3H	2	TMMK2000-200M	1	ATKK12-G1731
-14	G1731-14Z-32FM	M30 X 2	1	45ZH-28	2	G1731-03-C3H	2	TMMK2000-200M	1	ATKK14-G1731
-16	G1731-16Z-32FM	M33 X 2	1	45ZH-31	2	G1731-04-C3H	2	TMMK2000-200M	1	ATKK16-G1731
-18	G1731-18Z-32FM	M38 X 2	1	45ZH-36	1	G1731-04-C3H	2	TMMK2000-200M	2	ATKK18-G1731
-20	G1731-20Z-32FM	M42 X 2	1	45ZH-40	1	G1731-05-C3H	2	TMMK2000-200M	1	ATKK20-G1731
-24	G1731-24Z-32FM	M48 X 2	1	45ZH-46	1	G1731-05-C3H	2	TMMK2000-200M	1	ATKK24-G1731
-32	G1731-32Z-32FM	M60 X 2	1	45ZH-58	1	G1731-06-C3H	2	TMMK2000-200M	1	ATKK32-G1731

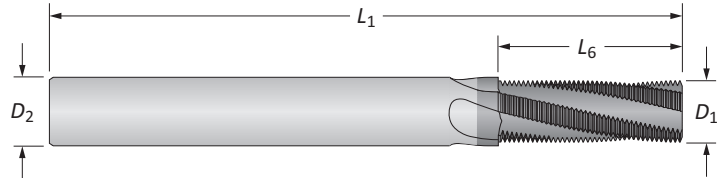

### AccuThread™ Port Specific Solid Carbide Thread Mills

Port Size	Pitch	Thread Mill				Flutes	Part No.
		$D_1$	$L_6$	$D_2$	$L_1$		
-4	1.50	7.40	19.50	8.00	64.00	4	TMMK1000-150M
-5 to -6	1.50	10.90	27.00	12.00	84.00	4	TMMK1400-150M
-8 to -10	1.50	11.90	31.50	12.00	84.00	4	TMMK1800-150M
-12 to -32	2.00	11.95	30.00	12.00	84.00	4	TMMK2000-200M

AccuPort 432 specific thread mills - International Unified Series (UN) manufactured specifically for use with AccuPort 432 hydraulic port forms. The length of cut allows full thread with one pass. Conforms with J1926 and SAE AS5202 port form specifications.

A92: 30 - 37      A92: 2 - 4      A92: 16 - 17

Key on A92: 1



## Recommended Drilling Data | Imperial (inch)

HSS

ISO	Material	Hardness (BHN)	Grade	Speed (SFM)				Feed Rate (IPR) by Tube Size and T-A® Insert Series					
				TiN	TiAlN	TiCN	AM200®	Tube No. 4 - 5	Tube No. 6 - 8	Tube No. 10	Tube No. 12 - 16	Tube No. 20 - 24	Tube No. 32
								T-A Series Y - Z	T-A Series 0	T-A Series 1	T-A Series 2	T-A Series 3	T-A Series 4
P	Free Machining Steel 1118, 1215, 12L14, etc.	100 - 150	HSS	200	280	260	325	0.007	0.010	0.013	0.016	0.020	0.023
		150 - 200	HSS	180	260	235	300	0.007	0.010	0.013	0.016	0.020	0.023
		200 - 250	HSS	160	240	210	280	0.006	0.010	0.013	0.016	0.020	0.023
	Low Carbon Steel 1010, 1020, 1025, 1522, 1144, etc.	85 - 125	HSS	170	250	220	290	0.006 ❖	0.009	0.012	0.015	0.019	0.023
		125 - 175	HSS	160	240	210	275	0.006 ❖	0.009	0.012	0.015	0.019	0.023
		175 - 225	HSS	150	225	195	260	0.005 ❖	0.008	0.010	0.014	0.018	0.021
	Medium Carbon Steel 1030, 1040, 1050, 1527, 1140, 1151, etc.	125 - 175	HSS	160	240	210	275	0.006	0.009	0.012	0.015	0.019	0.023
		175 - 225	HSS	150	225	195	260	0.005	0.008	0.010	0.014	0.018	0.021
		225 - 275	HSS	140	210	180	240	0.005	0.008	0.010	0.014	0.018	0.021
	Alloy Steel 4140, 5140, 8640, etc.	125 - 175	HSS	150	210	195	240	0.006	0.008	0.010	0.014	0.017	0.019
		175 - 225	HSS	140	195	180	225	0.005	0.008	0.010	0.014	0.017	0.019
		225 - 275	HSS	130	180	170	210	0.005	0.007	0.010	0.014	0.017	0.019
		275 - 325	SC	120	170	155	195	0.004	0.006	0.009	0.012	0.015	0.017
	High Strength Alloy 4340, 4330V, 300M, etc.	325 - 375	SC	110	155	145	180	0.003	0.006	0.009	0.012	0.015	0.017
		225 - 300	SC	80	110	100	125	0.005 ❖	0.007	0.009	0.010	0.014	0.017
		300 - 350	SC	60	85	80	100	0.004 ❖	0.007	0.009	0.010	0.014	0.017
	Structural Steel A36, A285, A516, etc.	350 - 400	SC	50	70	65	80	0.003 ❖	0.006	0.008	0.009	0.012	0.015
		100 - 150	HSS	140	200	180	235	0.006 ❖	0.010	0.012	0.014	0.018	0.021
150 - 250		HSS	120	170	155	190	0.005 ❖	0.009	0.010	0.012	0.016	0.019	
Tool Steel H-13, H-21, A-4, O-2, S-3, etc.	250 - 350	SC	100	140	130	160	0.004 ❖	0.009	0.009	0.010	0.014	0.017	
	150 - 200	SC	80	110	105	125	0.004 ❖	0.006	0.008	0.010	0.014	0.015	
S	High Temp Alloy Hastelloy B, Inconel 600, etc.	200 - 250	SC	60	90	85	105	0.004 ❖	0.006	0.008	0.010	0.012	0.015
		140 - 220	SC	30	40	35	45	0.003 ❖	0.007	0.008	0.010	0.012	0.015
M	Stainless Steel 400 Series 416, 420, 303, etc.	220 - 310	SC	25	35	30	40	0.003 ❖	0.006	0.007	0.008	0.010	0.012
		185 - 275	SC	75	105	95	110	0.006 ❖	0.008	0.009	0.011	0.012	0.016
K	Nodular, Grey, Ductile Cast Iron	275 - 350	SC	60	90	80	100	0.005 ❖	0.007	0.008	0.010	0.012	0.014
		120 - 150	HSS	170	250	220	290	0.007	0.012	0.016	0.020	0.024	0.027
		150 - 200	HSS	150	225	195	260	0.006	0.011	0.014	0.018	0.022	0.025
		200 - 220	HSS	130	195	170	225	0.006	0.009	0.012	0.016	0.018	0.021
		220 - 260	SC	110	165	145	190	0.005	0.007	0.009	0.012	0.014	0.017
260 - 320	SC	90	135	120	155	0.004	0.006	0.007	0.009	0.012	0.014		
N	Aluminum	30	HSS	600	850	750	-	0.008	0.013	0.016	0.020	0.022	0.025
		180	HSS	300	450	400	-	0.008	0.013	0.016	0.018	0.022	0.025

### Formulas

<p>1. <b>RPM = (3.82 • SFM) / DIA</b></p> <p>where:</p> <p>RPM = revolutions per minute (rev/min)</p> <p>SFM = speed (ft/min)</p> <p>DIA = finish diameter of drill (inch)</p>	<p>2. <b>SFM = RPM • 0.262 • DIA</b></p> <p>where:</p> <p>SFM = speed (ft/min)</p> <p>RPM = revolutions per minute (rev/min)</p> <p>DIA = diameter of drill (inch)</p>	<p>3. <b>IPM = RPM • IPR</b></p> <p>where:</p> <p>IPM = Feed rate</p> <p>RPM = revolutions per minute (rev/min)</p> <p>IPR = feed rate (in/rev)</p>
--	--	---

The table and equations on this page are found in the *Machinery's Handbook*. Permission to simplify and print the equations is granted by the Editor of the *Machinery's Handbook*.

**IMPORTANT:** The speeds and feeds listed above are a general starting point for all applications. Refer to the Coolant Recommendation charts for coolant requirements to run at the recommended speeds and feeds. Factory technical assistance is also available through our Application Engineering Team. Due to potential chip formation issues, contact our Application Engineering Team for assistance machining materials marked with a ❖.



## Coolant Recommendations | Imperial (inch)

HSS

ISO	Material	Pressure / Flow Rate	Tube No. 4 - 5	Tube No. 6 - 8	Tube No. 10	Tube No. 12 - 16	Tube No. 20 - 24	Tube No. 32
			T-A Series Y - Z	T-A Series 0	T-A Series 1	T-A Series 2	T-A Series 3	T-A Series 4
P	<b>Free Machining Steel</b> 1118, 1215, 12L14, etc.	PSI	175 - 185	100 - 120	105 - 140	80 - 115	75 - 100	40 - 50
		GPM	2.5 - 2.6	2.8 - 3.0	4.4 - 5.2	7 - 8	12 - 14	30 - 33
	<b>Low Carbon Steel</b> 1010, 1020, 1025, 1522, 1144, etc.	PSI	165 - 170	75 - 90	75 - 95	60 - 80	55 - 75	30 - 40
		GPM	2.4 - 2.5	2.4 - 2.6	3.7 - 4.2	6 - 7	11 - 12	26 - 30
	<b>Medium Carbon Steel</b> 1030, 1040, 1050, 1527, 1140, 1151, etc.	PSI	160 - 165	70 - 85	70 - 90	55 - 75	50 - 70	30 - 40
		GPM	2.3 - 2.4	2.3 - 2.6	3.7 - 4.2	5 - 6	10 - 12	26 - 30
	<b>Alloy Steel</b> 4140, 5140, 8640, etc.	PSI	160 - 165	65 - 75	65 - 80	50 - 70	45 - 60	30 - 35
		GPM	2.3 - 2.4	2.2 - 2.4	3.5 - 3.9	5 - 6	10 - 11	26 - 28
	<b>High Strength Alloy</b> 4340, 4330V, 300M, etc.	PSI	150 - 155	55 - 60	45 - 50	25 - 30	25 - 30	20 - 25
		GPM	2.3 - 2.4	2.1 - 2.2	2.9 - 3.1	4 - 5	7 - 8	21 - 23
	<b>Structural Steel</b> A36, A285, A516, etc.	PSI	160 - 165	75 - 85	65 - 80	40 - 55	40 - 50	25 - 30
		GPM	2.3 - 2.4	2.4 - 2.6	3.5 - 3.9	5 - 6	9 - 10	23 - 26
	<b>Tool Steel</b> H-13, H-21, A-4, O-2, S-3, etc.	PSI	150 - 155	55 - 60	45 - 50	25 - 30	25 - 30	20 - 25
		GPM	2.3 - 2.4	2.1 - 2.2	2.9 - 3.1	4 - 5	7 - 8	21 - 23
S	<b>High Temp Alloy</b> Hastelloy B, Inconel 600, etc.	PSI	150 - 155	60 - 65	50 - 55	30 - 35	25 - 30	25 - 30
		GPM	2.3 - 2.4	2.2 - 2.3	3.1 - 3.2	4 - 5	7 - 8	23 - 26
M	<b>Stainless Steel 400 Series</b> 416, 420, 303, etc.	PSI	171	86	75	55	51	29
		GPM	3	3	4	6	10	26
K	<b>Nodular, Grey, Ductile Cast Iron</b>	PSI	160	65	61	41	35	29
		GPM	2	2	3	5	9	26
N	<b>Aluminum</b>	PSI	210	180	230	159	125	51
		GPM	3	4	6	9	16	33

**IMPORTANT:** The coolant pressure and flow rate recommendations above represent a good approximation to obtain optimum tool life and chip evacuation at Allied's recommended speeds and feeds. If lower coolant capabilities exist in a drilling application, the AccuPort 432 Port Contour Cutter will still function at reduced penetration rates. Contact our Application Engineering Department for a more specific recommendation of coolant requirements and/or speeds and feeds.

A  
DRILLING  
B  
BORING  
C  
REAMING  
D  
BURNISHING  
E  
THREADING  
X  
SPECIALS

## Recommended Drilling Data | Imperial (inch)

Carbide

ISO	Material	Hardness (BHN)	Grade	Speed (SFM)			Feed Rate (IPR) by Tube Size and T-A® Insert Series				
				TiN	TiAlN	AM200®	Tube No. 4 - 5	Tube No. 6 - 8	Tube No. 10	Tube No. 12 - 16	Tube No. 20 - 24
							T-A Series Y - Z	T-A Series 0	T-A Series 1	T-A Series 2	T-A Series 3
P	Free Machining Steel 1118, 1215, 12L14, etc.	100 - 150	C1, C5	320	420	480	0.008	0.012	0.015	0.018	0.021
		150 - 200	C1, C5	280	360	415	0.007	0.011	0.014	0.016	0.019
		200 - 250	C1, C5	260	340	390	0.006	0.010	0.013	0.015	0.017
	Low Carbon Steel 1010, 1020, 1025, 1522, 1144, etc.	85 - 125	C1, C5	300	390	450	0.008 ❖	0.010	0.013	0.017	0.019
		125 - 175	C1, C5	260	340	390	0.007 ❖	0.010	0.013	0.016	0.018
		175 - 225	C1, C5	240	310	355	0.006 ❖	0.009	0.012	0.015	0.017
		225 - 275	C1, C5	210	270	310	0.005 ❖	0.009	0.012	0.015	0.017
	Medium Carbon Steel 1030, 1040, 1050, 1527, 1140, 1151, etc.	125 - 175	C1, C5	260	340	390	0.007	0.010	0.013	0.016	0.018
		175 - 225	C1, C5	240	310	355	0.006	0.009	0.012	0.015	0.017
		225 - 275	C1, C5	210	270	310	0.006	0.009	0.012	0.015	0.017
		275 - 325	C1, C5	180	230	265	0.005	0.008	0.011	0.014	0.016
	Alloy Steel 4140, 5140, 8640, etc.	125 - 175	C1, C5	250	325	375	0.007	0.010	0.013	0.016	0.018
		175 - 225	C1, C5	230	300	345	0.006	0.009	0.012	0.015	0.017
		225 - 275	C1, C5	210	270	310	0.006	0.009	0.012	0.015	0.017
		275 - 325	C1, C5	200	250	285	0.005	0.008	0.011	0.014	0.016
		325 - 375	C1, C5	170	220	255	0.004	0.007	0.010	0.013	0.015
	High Strength Alloy 4340, 4330V, 300M, etc.	225 - 300	C1, C5	160	200	230	0.006 ❖	0.009	0.010	0.012	0.015
		300 - 350	C1, C5	140	180	205	0.005 ❖	0.008	0.009	0.011	0.014
		350 - 400	C1, C5	120	160	185	0.004 ❖	0.007	0.008	0.010	0.012
	Structural Steel A36, A285, A516, etc.	100 - 150	C1, C5	240	310	355	0.008 ❖	0.011	0.014	0.016	0.018
150 - 250		C1, C5	200	250	285	0.006 ❖	0.010	0.012	0.014	0.016	
250 - 350		C1, C5	180	230	265	0.005 ❖	0.009	0.011	0.012	0.014	
Tool Steel H-13, H-21, A-4, O-2, S-3, etc.	150 - 200	C1, C5	160	220	255	0.004 ❖	0.007	0.009	0.011	0.013	
	200 - 250	C1, C5	120	170	195	0.004 ❖	0.007	0.009	0.011	0.013	
S	High Temp Alloy Hastelloy B, Inconel 600, etc.	140 - 220	C2	80	105	120	0.004 ❖	0.007	0.009	0.011	0.013
		220 - 310	C2	60	85	95	0.004 ❖	0.006	0.008	0.010	0.012
M	Stainless Steel 400 Series 416, 420, 303, etc.	185 - 275	C2	160	210	240	0.007 ❖	0.009	0.012	0.014	0.016
		275 - 350	C2	120	160	185	0.006 ❖	0.008	0.011	0.012	0.014
K	Nodular, Grey, Ductile Cast Iron	120 - 150	C2, C3	320	460	500	0.008	0.012	0.015	0.019	0.023
		150 - 200	C2, C3	270	400	480	0.007	0.011	0.013	0.017	0.021
		200 - 220	C2, C3	240	360	430	0.006	0.009	0.012	0.015	0.018
		220 - 260	C2, C3	210	310	370	0.005	0.008	0.011	0.013	0.015
		260 - 320	C2, C3	180	270	335	0.005	0.007	0.010	0.011	0.013
N	Aluminum	30	C2	1200	1500	-	0.010	0.015	0.018	0.020	0.022
		180	C2	800	1000	-	0.009	0.013	0.016	0.018	0.020

### Formulas

<p>1. <b>RPM = (3.82 • SFM) / DIA</b></p> <p>where:</p> <p>RPM = revolutions per minute (rev/min)</p> <p>SFM = speed (ft/min)</p> <p>DIA = finish diameter of drill (inch)</p>	<p>2. <b>SFM = RPM • 0.262 • DIA</b></p> <p>where:</p> <p>SFM = speed (ft/min)</p> <p>RPM = revolutions per minute (rev/min)</p> <p>DIA = diameter of drill (inch)</p>	<p>3. <b>IPM = RPM • IPR</b></p> <p>where:</p> <p>IPM = Feed rate</p> <p>RPM = revolutions per minute (rev/min)</p> <p>IPR = feed rate (in/rev)</p>
--	--	---

The table and equations on this page are found in the *Machinery's Handbook*. Permission to simplify and print the equations is granted by the Editor of the *Machinery's Handbook*.

**IMPORTANT:** The speeds and feeds listed above are a general starting point for all applications. Refer to the Coolant Recommendation charts for coolant requirements to run at the recommended speeds and feeds. Factory technical assistance is also available through our Application Engineering Team. Due to potential chip formation issues, contact our Application Engineering Team for assistance machining materials marked with a ❖.

## Coolant Recommendations | Imperial (inch)

Carbide

ISO	Material	Pressure / Flow Rate	Tube No. 4 - 5	Tube No. 6 - 8	Tube No. 10	Tube No. 12 - 16	Tube No. 20 - 24
			T-A Series Y - Z	T-A Series 0	T-A Series 1	T-A Series 2	T-A Series 3
P	<b>Free Machining Steel</b> 1118, 1215, 12L14, etc.	PSI	195	140	160	140	155
		GPM	2.6	3.3	5.5	9	18
	<b>Low Carbon Steel</b> 1010, 1020, 1025, 1522, 1144, etc.	PSI	180	105	105	110	115
		GPM	2.5	2.9	4.4	8	15
	<b>Medium Carbon Steel</b> 1030, 1040, 1050, 1527, 1140, 1151, etc.	PSI	175	100	90	100	75
		GPM	2.5	2.8	4.1	7	13
	<b>Alloy Steel</b> 4140, 5140, 8640, etc.	PSI	165	85	100	75	70
		GPM	2.4	2.6	4.3	6	12
	<b>High Strength Alloy</b> 4340, 4330V, 300M, etc.	PSI	160	65	55	40	35
		GPM	2.4	2.3	3.2	5	8
	<b>Structural Steel</b> A36, A285, A516, etc.	PSI	175	115	105	75	70
		GPM	2.5	3	4.4	6	12
	<b>Tool Steel</b> H-13, H-21, A-4, O-2, S-3, etc.	PSI	155	60	55	40	35
		GPM	2.4	2.2	3.2	5	8
S	<b>High Temp Alloy</b> Hastelloy B, Inconel 600, etc.	PSI	150 - 155	60 - 65	50 - 55	30 - 35	25 - 30
		GPM	2.3 - 2.4	2.2 - 2.3	3.1 - 3.2	4 - 5	7 - 8
M	<b>Stainless Steel 400 Series</b> 416, 420, 303, etc.	PSI	329	239	260	250	190
		GPM	3	4	7	12	20
K	<b>Nodular, Grey, Ductile Cast Iron</b>	PSI	225	104	90	90	80
		GPM	3	3	4	7	13
N	<b>Aluminum</b>	PSI	350	319	315	284	200
		GPM	4	5	8	12	20

**IMPORTANT:** The coolant pressure and flow rate recommendations above represent a good approximation to obtain optimum tool life and chip evacuation at Allied's recommended speeds and feeds. If lower coolant capabilities exist in a drilling application, the AccuPort 432 Port Contour Cutter will still function at reduced penetration rates. Contact our Application Engineering Department for a more specific recommendation of coolant requirements and/or speeds and feeds.

A  
DRILLING  
B  
BORING  
C  
REAMING  
D  
BURNISHING  
E  
THREADING  
X  
SPECIALS

## Recommended Drilling Data | Metric (mm)

HSS

ISO	Material	Hardness (BHN)	Grade	Speed (M/min)				Feed Rate (mm/rev) by Tube Size and T-A® Insert Series					
				TiN	TiAlN	TiCN	AM200®	Tube No. 4 - 5	Tube No. 6 - 8	Tube No. 10	Tube No. 12 - 16	Tube No. 20 - 24	Tube No. 32
								T-A Series Y - Z	T-A Series 0	T-A Series 1	T-A Series 2	T-A Series 3	T-A Series 4
P	Free Machining Steel 1118, 1215, 12L14, etc.	100 - 150	HSS	61	85	79	92	0.18	0.25	0.33	0.41	0.51	0.58
		150 - 200	HSS	55	79	72	87	0.18	0.25	0.33	0.41	0.51	0.58
		200 - 250	HSS	49	73	64	81	0.15	0.25	0.33	0.41	0.51	0.58
	Low Carbon Steel 1010, 1020, 1025, 1522, 1144, etc.	85 - 125	HSS	52	76	67	84	0.15 ❖	0.23	0.30	0.38	0.48	0.58
		125 - 175	HSS	49	73	64	81	0.15 ❖	0.23	0.30	0.38	0.48	0.58
		175 - 225	HSS	46	69	59	76	0.13 ❖	0.20	0.25	0.36	0.46	0.53
		225 - 275	HSS	43	64	55	70	0.13 ❖	0.20	0.25	0.36	0.46	0.53
	Medium Carbon Steel 1030, 1040, 1050, 1527, 1140, 1151, etc.	125 - 175	HSS	49	73	64	79	0.15	0.23	0.30	0.38	0.48	0.58
		175 - 225	HSS	46	69	59	75	0.13	0.20	0.25	0.36	0.46	0.53
		225 - 275	HSS	43	64	55	70	0.13	0.20	0.25	0.36	0.46	0.53
		275 - 325	SC	40	59	52	66	0.10	0.18	0.23	0.30	0.41	0.48
	Alloy Steel 4140, 5140, 8640, etc.	125 - 175	HSS	46	64	59	69	0.15	0.20	0.25	0.36	0.43	0.48
		175 - 225	HSS	43	59	55	66	0.13	0.20	0.25	0.36	0.43	0.48
		225 - 275	HSS	40	55	52	60	0.13	0.18	0.25	0.36	0.43	0.48
		275 - 325	SC	37	52	47	56	0.10	0.15	0.23	0.30	0.38	0.43
		325 - 375	SC	34	47	44	55	0.08	0.15	0.23	0.30	0.38	0.43
	High Strength Alloy 4340, 4330V, 300M, etc.	225 - 300	SC	24	34	30	37	0.13 ❖	0.18	0.23	0.25	0.36	0.43
		300 - 350	SC	18	26	24	27	0.10 ❖	0.18	0.23	0.25	0.36	0.43
		350 - 400	SC	15	21	20	23	0.08 ❖	0.15	0.20	0.23	0.30	0.38
	Structural Steel A36, A285, A516, etc.	100 - 150	HSS	43	61	55	67	0.15 ❖	0.25	0.30	0.36	0.46	0.53
150 - 250		HSS	37	52	47	56	0.13 ❖	0.23	0.25	0.30	0.41	0.48	
250 - 350		SC	30	43	40	47	0.10 ❖	0.20	0.23	0.25	0.36	0.43	
Tool Steel H-13, H-21, A-4, O-2, S-3, etc.	150 - 200	SC	24	34	32	37	0.10	0.15	0.20	0.25	0.30	0.38	
	200 - 250	SC	18	27	26	31	0.10	0.15	0.20	0.25	0.30	0.38	
S	High Temp Alloy Hastelloy B, Inconel 600, etc.	140 - 220	SC	30	40	35	45	0.08 ❖	0.18	0.20	0.25	0.30	0.38
		220 - 310	SC	25	35	30	40	0.08 ❖	0.15	0.18	0.20	0.25	0.30
M	Stainless Steel 400 Series 416, 420, 303, etc.	185 - 275	SC	23	32	29	33	0.15 ❖	0.20	0.23	0.28	0.36	0.41
		275 - 350	SC	18	27	24	29	0.13 ❖	0.18	0.20	0.25	0.30	0.36
K	Nodular, Grey, Ductile Cast Iron	120 - 150	HSS	52	76	67	82	0.18	0.30	0.41	0.51	0.61	0.69
		150 - 200	HSS	46	69	59	75	0.15	0.28	0.36	0.46	0.56	0.64
		200 - 220	HSS	40	59	52	66	0.15	0.23	0.30	0.41	0.46	0.53
		220 - 260	SC	34	50	44	55	0.13	0.18	0.23	0.30	0.36	0.43
		260 - 320	SC	27	41	37	44	0.10	0.15	0.18	0.23	0.30	0.36
N	Aluminum	30	HSS	183	259	229	-	0.20	0.33	0.41	0.51	0.56	0.64
		180	HSS	91	137	122	-	0.20	0.33	0.41	0.46	0.56	0.64

### Formulas

<p>1. <math>RPM = (318.47 \cdot M/min) / DIA</math></p> <p>where:</p> <p>RPM = revolutions per minute (rev/min)</p> <p>M/min = speed (M/min)</p> <p>DIA = finish diameter of drill (mm)</p>	<p>2. <math>M/min = RPM \cdot 0.003 \cdot DIA</math></p> <p>where:</p> <p>M/min = speed (M/min)</p> <p>RPM = revolutions per minute (rev/min)</p> <p>DIA = diameter of drill (mm)</p>	<p>3. <math>IPM = RPM \cdot mm/rev</math></p> <p>where:</p> <p>IPM = feed rate</p> <p>RPM = revolutions per minute (rev/min)</p> <p>mm/rev = feed rate (mm/rev)</p>
---	---	---

The table and equations on this page are found in the *Machinery's Handbook*. Permission to simplify and print the equations is granted by the Editor of the *Machinery's Handbook*.

**IMPORTANT:** The speeds and feeds listed above are a general starting point for all applications. Refer to the Coolant Recommendation charts for coolant requirements to run at the recommended speeds and feeds. Factory technical assistance is also available through our Application Engineering Team. Due to potential chip formation issues, contact our Application Engineering Team for assistance machining materials marked with a ❖.

## Coolant Recommendations | Metric (mm)

HSS

ISO	Material	Pressure / Flow Rate	Tube No. 4 - 5	Tube No. 6 - 8	Tube No. 10	Tube No. 12 - 16	Tube No. 20 - 24	Tube No. 32
			T-A Series Y - Z	T-A Series 0	T-A Series 1	T-A Series 2	T-A Series 3	T-A Series 4
P	<b>Free Machining Steel</b> 1118, 1215, 12L14, etc.	BAR	12 - 13	7 - 8	7 - 10	6 - 8	6 - 7	3 - 4
		LPM	9.5 - 9.8	10.6 - 11.4	16.7 - 19.7	26.5 - 30.3	45.4 - 53.0	114 - 125
	<b>Low Carbon Steel</b> 1010, 1020, 1025, 1522, 1144, etc.	BAR	11 - 12	5 - 6	5 - 7	4 - 6	4 - 5	2 - 3
		LPM	9.1 - 9.5	9.1 - 9.8	14.0 - 15.9	22.7 - 26.5	41.6 - 45.4	98 - 114
	<b>Medium Carbon Steel</b> 1030, 1040, 1050, 1527, 1140, 1151, etc.	BAR	11	5 - 6	5 - 6	4 - 5	3 - 5	2 - 3
		LPM	8.7 - 9.1	8.7 - 9.8	13.6 - 15.5	18.9 - 22.7	37.9 - 45.4	98 - 114
	<b>Alloy Steel</b> 4140, 5140, 8640, etc.	BAR	11	5 - 6	5	3 - 5	3 - 4	2
		LPM	8.7 - 9.1	13.2 - 14.8	8.3 - 9.1	18.9 - 22.7	34.1 - 37.9	87 - 98
	<b>High Strength Alloy</b> 4340, 4330V, 300M, etc.	BAR	10 - 11	4 - 5	3 - 4	2	2	2
		LPM	8.7 - 9.1	7.9 - 8.3	11.0 - 11.7	15.1 - 18.9	26.5 - 30.3	79 - 87
	<b>Structural Steel</b> A36, A285, A516, etc.	BAR	11	5 - 6	5 - 6	3 - 4	3	2
		LPM	8.7 - 9.1	9.1 - 9.8	13.2 - 14.8	18.9 - 22.7	34.1 - 37.9	87 - 98
	<b>Tool Steel</b> H-13, H-21, A-4, O-2, S-3, etc.	BAR	4	10 - 11	3	2	2	1 - 2
		LPM	7.9 - 8.3	8.7 - 9.1	11.0 - 11.7	15.1 - 18.9	26.5 - 30.3	79 - 87
S	<b>High Temp Alloy</b> Hastelloy B, Inconel 600, etc.	BAR	10 - 11	4 - 5	3 - 4	2	2	2
		LPM	8.7 - 9.1	8.3 - 8.7	11.7 - 12.1	15.1 - 18.9	26.5 - 30.3	87 - 98
M	<b>Stainless Steel 400 Series</b> 416, 420, 303, etc.	BAR	11.4 - 11.7	4.8 - 5.8	4.5 - 5.2	2.7 - 3.8	2.7 - 3.4	1.7 - 2
		LPM	9.1 - 9.5	8.7 - 9.8	13.2 - 14	18.9 - 22.7	34.1 - 37.9	87 - 98
K	<b>Nodular, Grey, Ductile Cast Iron</b>	BAR	10.7 - 11.0	4.1 - 4.5	3.4 - 4.1	2 - 2.7	2 - 2.4	1.7 - 2
		LPM	8.7 - 9.1	8.3 - 8.7	11.7 - 12.5	15.1 - 18.9	30.3 - 34.1	87 - 98
N	<b>Aluminum</b>	BAR	13.1 - 14.5	9.6 - 12.4	10.3 - 15.8	7.9 - 11	6.2 - 8.6	2.7 - 3.4
		LPM	9.8 - 10.2	12.5 - 14	20.1 - 23.1	30.3 - 34.1	53 - 60.6	114 - 125

**IMPORTANT:** The coolant pressure and flow rate recommendations above represent a good approximation to obtain optimum tool life and chip evacuation at Allied's recommended speeds and feeds. If lower coolant capabilities exist in a drilling application, the AccuPort 432 Port Contour Cutter will still function at reduced penetration rates. Contact our Application Engineering Department for a more specific recommendation of coolant requirements and/or speeds and feeds.

A  
DRILLING  
B  
BORING  
C  
REAMING  
D  
BURNISHING  
E  
THREADING  
X  
SPECIALS



## Recommended Drilling Data | Metric (mm)

Carbide

ISO	Material	Hardness (BHN)	Grade	Speed (M/min)			Feed Rate (mm/rev) by Tube Size and T-A® Insert Series				
				TiN	TiAlN	AM200®	Tube No. 4 - 5	Tube No. 6 - 8	Tube No. 10	Tube No. 12 - 16	Tube No. 20 - 24
							T-A Series Y - Z	T-A Series 0	T-A Series 1	T-A Series 2	T-A Series 3
P	Free Machining Steel 1118, 1215, 12L14, etc.	100 - 150	K35, P40	98	128	146	0.020	0.30	0.38	0.46	0.53
		150 - 200	K35, P40	85	110	126	0.18	0.28	0.36	0.41	0.48
		200 - 250	K35, P40	79	104	119	0.15	0.25	0.33	0.38	0.43
	Low Carbon Steel 1010, 1020, 1025, 1522, 1144, etc.	85 - 125	K35, P40	91	119	137	0.20 ❖	0.25	0.33	0.43	0.48
		125 - 175	K35, P40	79	104	119	0.18 ❖	0.25	0.33	0.41	0.46
		175 - 225	K35, P40	73	94	108	0.15 ❖	0.23	0.30	0.38	0.43
		225 - 275	K35, P40	64	82	94	0.13 ❖	0.23	0.30	0.38	0.43
	Medium Carbon Steel 1030, 1040, 1050, 1527, 1140, 1151, etc.	125 - 175	K35, P40	79	104	119	0.18	0.25	0.33	0.41	0.46
		175 - 225	K35, P40	73	94	108	0.15	0.23	0.30	0.38	0.43
		225 - 275	K35, P40	64	82	94	0.15	0.23	0.30	0.38	0.43
		275 - 325	K35, P40	55	70	81	0.13	0.20	0.28	0.36	0.41
	Alloy Steel 4140, 5140, 8640, etc.	125 - 175	K35, P40	76	99	114	0.18	0.25	0.33	0.41	0.46
		175 - 225	K35, P40	70	91	105	0.15	0.23	0.30	0.38	0.43
		225 - 275	K35, P40	64	82	94	0.15	0.23	0.30	0.38	0.43
		275 - 325	K35, P40	61	76	87	0.13	0.20	0.28	0.36	0.41
		325 - 375	K35, P40	52	67	78	0.10	0.18	0.25	0.33	0.38
	High Strength Alloy 4340, 4330V, 300M, etc.	225 - 300	K35, P40	49	61	73	0.15 ❖	0.23	0.25	0.30	0.38
		300 - 350	K35, P40	43	55	62	0.13 ❖	0.20	0.23	0.28	0.36
350 - 400		K35, P40	37	49	56	0.10 ❖	0.18	0.20	0.25	0.30	
Structural Steel A36, A285, A516, etc.	100 - 150	K35, P40	73	94	108	0.20 ❖	0.28	0.36	0.41	0.46	
	150 - 250	K35, P40	61	76	87	0.15 ❖	0.25	0.30	0.36	0.41	
	250 - 350	K35, P40	55	70	81	0.13 ❖	0.23	0.28	0.30	0.36	
Tool Steel H-13, H-21, A-4, O-2, S-3, etc.	150 - 200	K35, P40	49	67	78	0.10 ❖	0.18	0.23	0.28	0.33	
	200 - 250	K35, P40	37	52	59	0.10 ❖	0.18	0.23	0.28	0.33	
S	High Temp Alloy Hastelloy B, Inconel 600, etc.	140 - 220	K20	24	32	36	0.10 ❖	0.18	0.23	0.28	0.33
		220 - 310	K20	18	26	29	0.10 ❖	0.15	0.20	0.25	0.30
M	Stainless Steel 400 Series 416, 420, 303, etc.	185 - 275	K20	49	64	73	0.18 ❖	0.23	0.30	0.36	0.41
		275 - 350	K20	37	49	46	0.15 ❖	0.20	0.28	0.30	0.36
K	Nodular, Grey, Ductile Cast Iron	120 - 150	K20, K10	98	140	152	0.20	0.30	0.38	0.48	0.58
		150 - 200	K20, K10	82	122	146	0.18	0.28	0.33	0.43	0.53
		200 - 220	K20, K10	73	110	131	0.15	0.23	0.30	0.38	0.46
		220 - 260	K20, K10	64	94	113	0.13	0.20	0.28	0.33	0.38
		260 - 320	K20, K10	55	82	102	0.13	0.18	0.25	0.28	0.33
N	Aluminum	30	K20	366	457	-	0.25	0.38	0.46	0.51	0.56
		180	K20	244	305	-	0.23	0.33	0.41	0.46	0.51

### Formulas

<p>1. <math>RPM = (318.47 \cdot M/min) / DIA</math></p> <p>where:</p> <p>RPM = revolutions per minute (rev/min)</p> <p>M/min = speed (M/min)</p> <p>DIA = finish diameter of drill (mm)</p>	<p>2. <math>M/min = RPM \cdot 0.003 \cdot DIA</math></p> <p>where:</p> <p>M/min = speed (M/min)</p> <p>RPM = revolutions per minute (rev/min)</p> <p>DIA = diameter of drill (mm)</p>	<p>3. <math>IPM = RPM \cdot mm/rev</math></p> <p>where:</p> <p>IPM = feed rate</p> <p>RPM = revolutions per minute (rev/min)</p> <p>mm/rev = feed rate (mm/rev)</p>
---	---	---

The table and equations on this page are found in the *Machinery's Handbook*. Permission to simplify and print the equations is granted by the Editor of the *Machinery's Handbook*.

**IMPORTANT:** The speeds and feeds listed above are a general starting point for all applications. Refer to the Coolant Recommendation charts for coolant requirements to run at the recommended speeds and feeds. Factory technical assistance is also available through our Application Engineering Team. Due to potential chip formation issues, contact our Application Engineering Team for assistance machining materials marked with a ❖.

## Coolant Recommendations | Metric (mm)

Carbide

ISO	Material	Pressure / Flow Rate	Tube No.	Tube No.	Tube No.	Tube No.	Tube No.
			4 - 5	6 - 8	10	12 - 16	20 - 24
			T-A Series Y - Z	T-A Series 0	T-A Series 1	T-A Series 2	T-A Series 3
P	<b>Free Machining Steel</b> 1118, 1215, 12L14, etc.	BAR	20	16	17	15	12
		LPM	12.2	16.3	25.3	41.5	71.9
	<b>Low Carbon Steel</b> 1010, 1020, 1025, 1522, 1144, etc.	BAR	11.4	13.3	20.6	36.5	62
		LPM	17	10	10	10	8
	<b>Medium Carbon Steel</b> 1030, 1040, 1050, 1527, 1140, 1151, etc.	BAR	17	9	10	8	7
		LPM	11.1	12.3	19.3	30	55.8
	<b>Alloy Steel</b> 4140, 5140, 8640, etc.	BAR	10.4	9.1	12.6	18.8	33.6
		LPM	16	9	8	7	5
	<b>High Strength Alloy</b> 4340, 4330V, 300M, etc.	BAR	15	5	5	3	3
		LPM	10.4	9.1	13.6	19.7	36.5
	<b>Structural Steel</b> A36, A285, A516, etc.	BAR	16	9	8	7	5
		LPM	10.8	12	17.5	27.8	47.1
	<b>Tool Steel</b> H-13, H-21, A-4, O-2, S-3, etc.	BAR	15	5	5	3	3
		LPM	10.4	9.1	13.6	19.7	36.5
S	<b>High Temp Alloy</b> Hastelloy B, Inconel 600, etc.	BAR	17	11.4	12.4	11	9
		LPM	11.1	13.5	21.9	35.4	62
M	<b>Stainless Steel 400 Series</b> 416, 420, 303, etc.	BAR	22.7	16.5	17.9	17.2	13.1
		LPM	13	16.3	26.3	44.2	75
K	<b>Nodular, Grey, Ductile Cast Iron</b>	BAR	15.5	7.2	6.2	6.2	5.5
		LPM	10.7	10.8	15.4	26.5	48.7
N	<b>Aluminum</b>	BAR	24.1	22	21.7	19.6	13.8
		LPM	13.4	18.8	29	47.2	77

**IMPORTANT:** The coolant pressure and flow rate recommendations above represent a good approximation to obtain optimum tool life and chip evacuation at Allied's recommended speeds and feeds. If lower coolant capabilities exist in a drilling application, the AccuPort 432 Port Contour Cutter will still function at reduced penetration rates. Contact our Application Engineering Department for a more specific recommendation of coolant requirements and/or speeds and feeds.

A  
DRILLING  
B  
BORING  
C  
REAMING  
D  
BURNISHING  
E  
THREADING  
X  
SPECIALS





SECTION

---

# A93

---

BT-A Drill

# BT-A Drill

## BTA (STS) Deep Hole Machining System

▶ **Diameter Range:** 0.5100" - 1.8820" (12.95mm - 47.80mm)



### Material Ejection with Efficiency

The BT-A Drill (using the single tube system, or STS) conquers deep hole applications in ways other drills simply cannot. The internal ejection system flushes chips and debris from the hole with no interference to the cutting process.

By utilizing the countless advantages of the T-A® drill insert, the BT-A design significantly increases penetration rates over brazed heads and traditional gun drills. A specific BT geometry has also been developed to increase productivity in these types of drilling applications.

Excellent hole size and finish	Optimizes chip evacuation	Up to <b>2x</b> the penetration rate of traditional BTA heads
--------------------------------	---------------------------	---

### Applicable Industries



Your safety and the safety of others is very important. This catalog contains important safety messages. Always read and follow all safety precautions.



This triangle is a safety hazard symbol. It alerts you to potential safety hazards that can cause tool failure and serious injury.

When you see this symbol in the catalog, look for a related safety message that may be near this triangle or referred to in the nearby text.

There are safety signal words also used in the catalog. Safety messages follow these words.

#### **WARNING**

**WARNING** (shown above) means that failure to follow the precautions in this message could result in tool failure and serious injury.

**NOTICE** means that failure to follow the precautions in this message could result in damage to the tool or machine but not result in personal injury.

**NOTE** and **IMPORTANT** are also used. These are important that you read and follow but are not safety-related.

Visit [www.alliedmachine.com](http://www.alliedmachine.com) for the most up-to-date information and procedures.

## Reference Icons

The following icons will appear throughout the catalog to help you navigate between products.

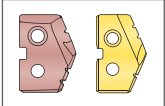

### T-A® Inserts

Refers to the range of inserts that connect with the corresponding holders

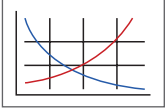

### Recommended Cutting Data

Speed and feed recommendations for optimum and safe drilling

## Introduction Information

System Overview . . . . . 2  
 Product Nomenclature . . . . . 3

## T-A Drill Series

0 Series . . . . . 4  
 1 Series . . . . . 5  
 2 Series . . . . . 6  
 3 Series . . . . . 7

Series	Diameter Range	
	Imperial (inch)	Metric (mm)
0	0.5100 - 0.6959	12.95 - 17.68
1	0.6960 - 0.9600	17.69 - 24.38
2	0.9601 - 1.3800	24.39 - 35.05
3	1.3801 - 1.8820	35.06 - 47.80

## System Overview

### BTA Machining

BTA machining is the reverse of typical gun drilling systems. The BT-A Drill is a drill head consisting of a holder body and a replaceable tip T-A® insert. The drill head threads into an STS (single tube system) cylindrical tube with a diameter smaller than the drill head. The difference in diameter forms an annular area between the hole and the tube OD. This allows high volume coolant to be directed to the cutting edge.

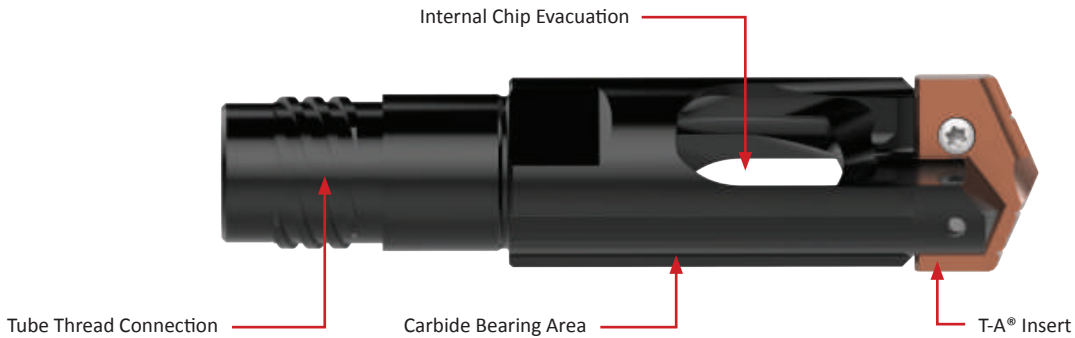

- ✓ **Improve hole straightness**  
with the laser clad bearing area
- ✓ **Eliminate the need for re-sharpening**  
with replaceable cutting edges
- ✓ **Reduce your inventory**  
with the replaceable T-A® feature
- ✓ **Compatibility**  
heads are compatible with standard BTA-STS systems
- ✓ **Balanced cutting forces**
- ✓ **Patent-pending design**

**Original T-A Insert: BT-A Geometry (-BT)**

- Low thrust web geometry reduces Z-axis requirements
- Tiny chip (-TC) lip geometry improves chip formation
- Polished cutting surface eliminates material build-up

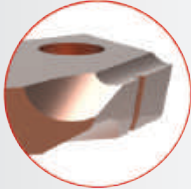

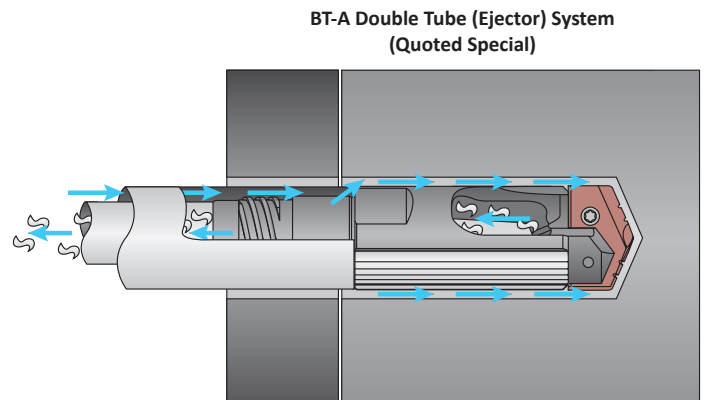
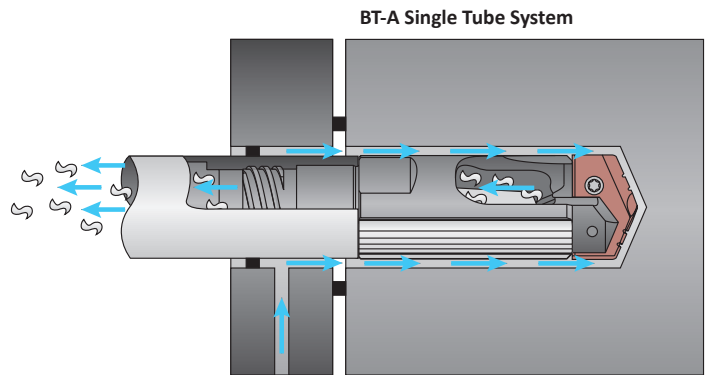

**2x INCREASE** in penetration rates over traditional BTA heads

A DRILLING B BORING C REAMING D BURNISHING E THREADING X SPECIALS

## Product Nomenclature

### BT-A Drill Holders

<b>BTA2</b>	–	<b>804</b>	–	<b>1.1299</b>
1		2		3

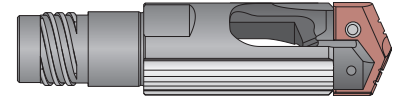

1. BT-A Drill T-A Insert Series
<b>BTA0</b> = 0 series T-A insert
<b>BTA1</b> = 1 series T-A insert
<b>BTA2</b> = 2 series T-A insert
<b>BTA3</b> = 3 series T-A insert

2. Tube Size		
794	800	806
795	801	807
796	802	808
797	803	809
798	804	810
799	805	811

3. Diameter
<b>0.7344</b> = Inch
<b>25.00</b> = Metric

#### Reference Key

Symbol	Attribute
$D_1$	Drill insert range
$L_1$	Overall length
$L_3$	Holder reference length
$L_7$	Shank length

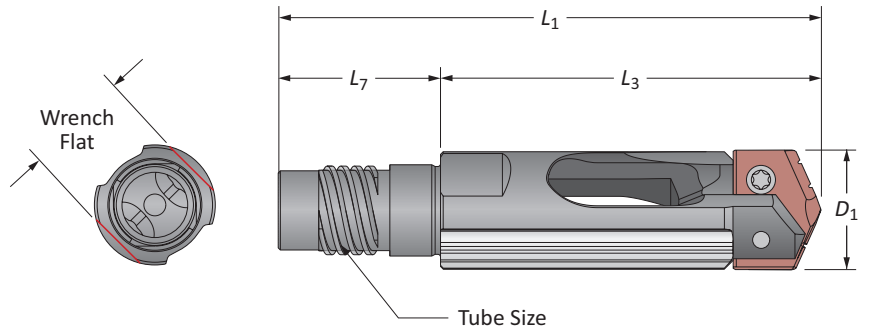

### BT-A Drill Tubes

<b>BTAT</b>	–	<b>804</b>	–	<b>63</b>
1		2		3

1. BT-A Drill T-A Insert Series
<b>BTAT</b> = BT-A Tube

2. Tube Size		
794	800	806
795	801	807
796	802	808
797	803	809
798	804	810
799	805	811

3. Length
<b>63</b> = Standard
<b>102</b> = Long

#### Reference Key

Symbol	Attribute
$D_1$	Body diameter
$ID_1$	Internal diameter
$L_1$	Overall length

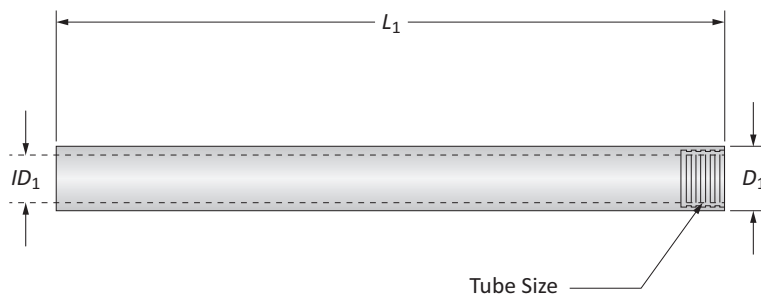

## BT-A Drill Holders

0 Series | Diameter Range: 0.5100" - 0.6959" (12.95mm - 17.68mm)

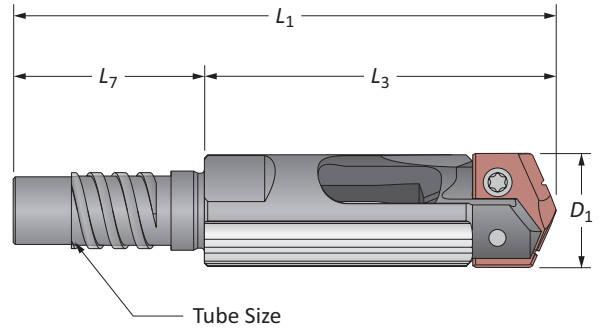
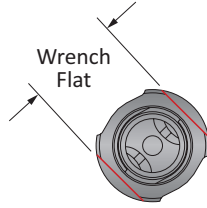

Tube Size	$D_1$	Holder				Part No.	 T-A® Insert	Wrench Flat (mm)
		$L_3$	$L_1$	$L_7$				
i	794	0.5100 - 0.5359	1-45/64	2-39/64	29/32	<b>BTA0-794-X.XXXX</b>	1C10H-XXXX-BT	11
	795	0.5360 - 0.5759	1-3/4	2-21/32	29/32	<b>BTA0-795-X.XXXX</b>	1C10H-XXXX-BT	12
	796	0.5760 - 0.6149	1-13/16	2-3/4	61/64	<b>BTA0-796-X.XXXX</b>	1C10H-XXXX-BT	13
	797	0.6150 - 0.6579	1-13/16	2-3/4	61/64	<b>BTA0-797-X.XXXX</b>	1C10H-XXXX-BT	14
	798	0.6580 - 0.6959	1-25/32	2-47/64	61/64	<b>BTA0-798-X.XXXX</b>	1C10H-XXXX-BT	15
m	794	12.95 - 13.61	43.4	66.4	23	<b>BTA0-794-XX.XX</b>	1C10H-XXXX-BT	11
	795	13.62 - 14.63	44.6	67.6	23	<b>BTA0-795-XX.XX</b>	1C10H-XXXX-BT	12
	796	14.64 - 15.62	45.9	69.9	24	<b>BTA0-796-XX.XX</b>	1C10H-XXXX-BT	13
	797	15.63 - 16.71	45.9	69.9	24	<b>BTA0-797-XX.XX</b>	1C10H-XXXX-BT	14
	798	16.72 - 17.68	45.3	69.3	24	<b>BTA0-798-XX.XX</b>	1C10H-XXXX-BT	15

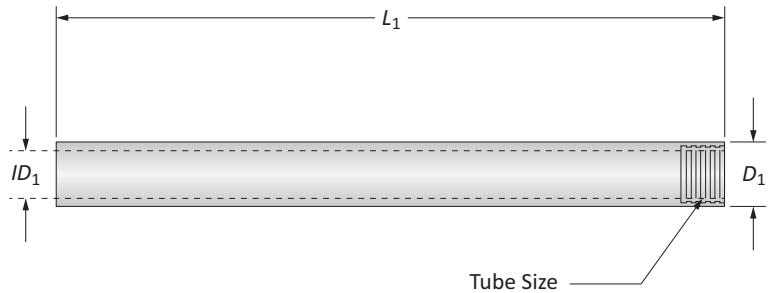

Tube Size	Tube			Part No.	
	$D_1$	$ID_1$	$L_1$		
i	794	0.433	0.276	63	<b>BTAT794-63</b>
	794	0.433	0.276	102	<b>BTAT794-102</b>
	795	0.472	0.315	63	<b>BTAT795-63</b>
	795	0.472	0.315	102	<b>BTAT795-102</b>
	796	0.512	0.335	63	<b>BTAT796-63</b>
	796	0.512	0.335	102	<b>BTAT796-102</b>
	797	0.551	0.354	63	<b>BTAT797-63</b>
	797	0.551	0.354	102	<b>BTAT797-102</b>
	798	0.591	0.394	63	<b>BTAT798-63</b>
	798	0.591	0.394	102	<b>BTAT798-102</b>

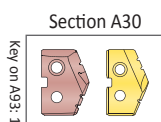

i = Imperial (in)  
m = Metric (mm)

### BT-A Drill Holders

1 Series | Diameter Range: 0.6960" - 0.9600" (17.69mm - 24.38mm)

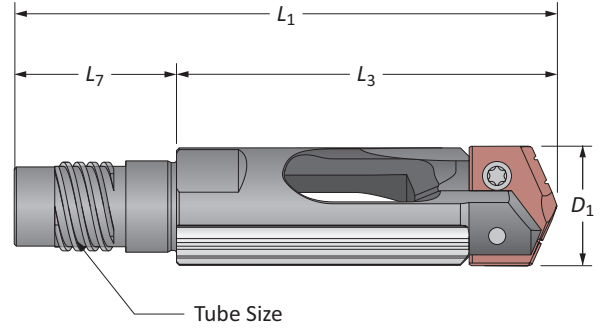
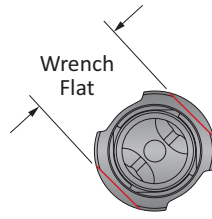

Tube Size	$D_1$	Holder			Part No.	T-A® Insert	Wrench Flat (mm)	
		$L_3$	$L_1$	$L_7$				
i	799	0.6960 - 0.7449	2-15/64	3-9/32	63/64	BTA1-799-X.XXXX	1C11H-XXXX-BT	16
	800	0.7450 - 0.7879	2-5/16	3-27/64	1-7/64	BTA1-800-X.XXXX	1C11H-XXXX-BT	17
	801	0.7880 - 0.8589	2-11/32	3-35/64	1-13/64	BTA1-801-X.XXXX	1C11H-XXXX-BT	18
	802	0.8590 - 0.9489	2-25/64	3-11/16	1-19/64	BTA1-802-X.XXXX	1C11H-XXXX-BT	19
	803	0.9490 - 0.9600	2-33/64	3-13/16	1-19/64	BTA1-803-X.XXXX	1C11H-XXXX-BT	21
m	799	17.69 - 18.92	58.2	83.2	25	BTA1-799-XX.XX	1C11H-XXXX-BT	16
	800	18.93 - 20.01	58.8	86.8	28	BTA1-800-XX.XX	1C11H-XXXX-BT	17
	801	20.02 - 21.81	59.4	89.9	30.5	BTA1-801-XX.XX	1C11H-XXXX-BT	18
	802	21.82 - 24.10	60.7	93.7	33	BTA1-802-XX.XX	1C11H-XXXX-BT	19
	803	24.11 - 24.38	63.9	96.9	33	BTA1-803-XX.XX	1C11H-XXXX-BT	21

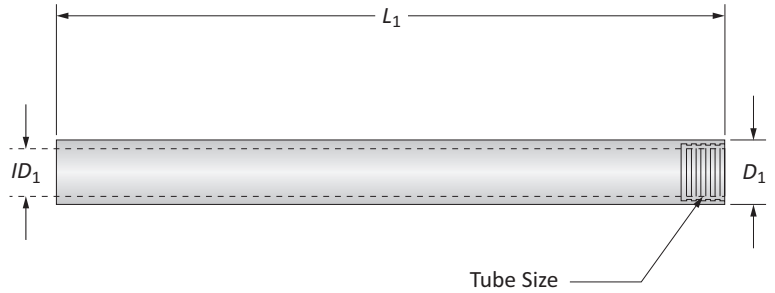

Tube Size	Tube			Part No.	
	$D_1$	$ID_1$	$L_1$		
i	799	0.630	0.413	63	BTAT799-63
	799	0.630	0.413	102	BTAT799-102
	800	0.669	0.453	63	BTAT800-63
	800	0.669	0.453	102	BTAT800-102
	801	0.709	0.472	63	BTAT801-63
	801	0.709	0.472	102	BTAT801-102
	802	0.787	0.512	63	BTAT802-63
	802	0.787	0.512	102	BTAT802-102
	803	0.866	0.551	63	BTAT803-63
	803	0.866	0.551	102	BTAT803-102

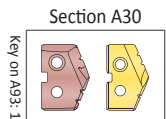

i = Imperial (in)  
m = Metric (mm)

## BT-A Drill Holders

2 Series | Diameter Range: 0.9601" - 1.3800" (24.39mm - 35.05mm)

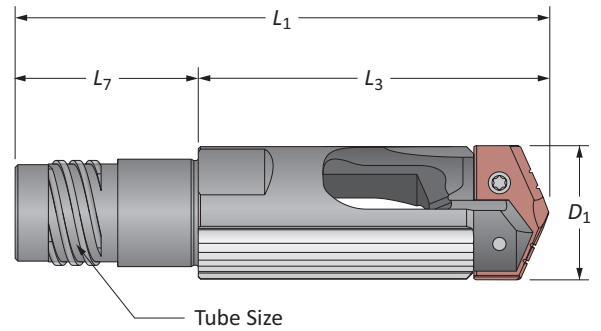
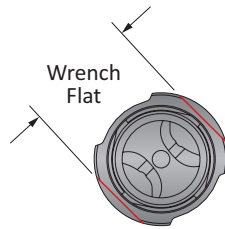

Tube Size	Holder				Part No.	 T-A® Insert	Wrench Flat (mm)	
	$D_1$	$L_3$	$L_1$	$L_7$				
i	803	0.9601 - 1.0399	3-3/32	4-25/64	1-19/64	<b>BTA2-803-X.XXXX</b>	1C12H-XXXX-BT	21
	804	1.0400 - 1.1299	3	4-3/32	1-7/64	<b>BTA2-804-X.XXXX</b>	1C12H-XXXX-BT	22
	805	1.1300 - 1.2209	2-31/32	4-25/64	1-27/64	<b>BTA2-805-X.XXXX</b>	1C12H-XXXX-BT	25
	806	1.2210 - 1.3119	3-1/16	4-31/64	1-27/64	<b>BTA2-806-X.XXXX</b>	1C12H-XXXX-BT	27
	807	1.3120 - 1.3800	3-1/16	4-31/64	1-27/64	<b>BTA2-807-X.XXXX</b>	1C12H-XXXX-BT	30
m	803	24.39 - 26.41	78.5	111.5	33	<b>BTA2-803-XX.XX</b>	1C12H-XXXX-BT	21
	804	26.42 - 28.70	75.9	103.9	28	<b>BTA2-804-XX.XX</b>	1C12H-XXXX-BT	22
	805	28.71 - 31.01	75.4	111.4	36	<b>BTA2-805-XX.XX</b>	1C12H-XXXX-BT	25
	806	31.02 - 33.32	77.9	113.8	36	<b>BTA2-806-XX.XX</b>	1C12H-XXXX-BT	27
	807	33.33 - 35.05	77.9	113.8	36	<b>BTA2-807-XX.XX</b>	1C12H-XXXX-BT	30

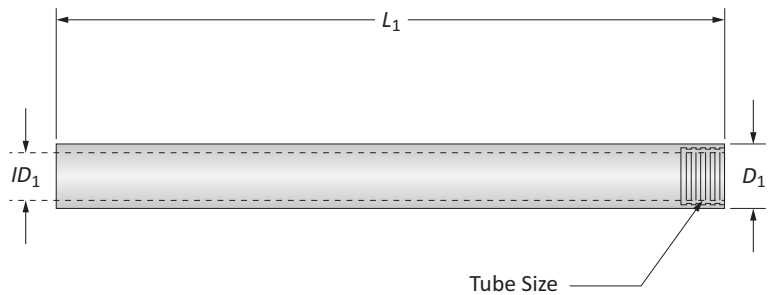

Tube Size	Tube			Part No.	
	$D_1$	$ID_1$	$L_1$		
i	803	0.866	0.551	63	<b>BTAT803-63</b>
	803	0.866	0.551	102	<b>BTAT803-102</b>
	804	0.945	0.610	63	<b>BTAT804-63</b>
	804	0.945	0.610	102	<b>BTAT804-102</b>
	805	1.024	0.669	63	<b>BTAT805-63</b>
	805	1.024	0.669	102	<b>BTAT805-102</b>
	806	1.102	0.728	102	<b>BTAT806-102</b>
	807	1.181	0.787	102	<b>BTAT807-102</b>

### Section A30

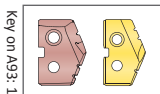

i = Imperial (in)  
m = Metric (mm)



**BT-A Drill Holders**

3 Series | Diameter Range: 1.3801" - 1.8820" (35.06mm - 47.80mm)

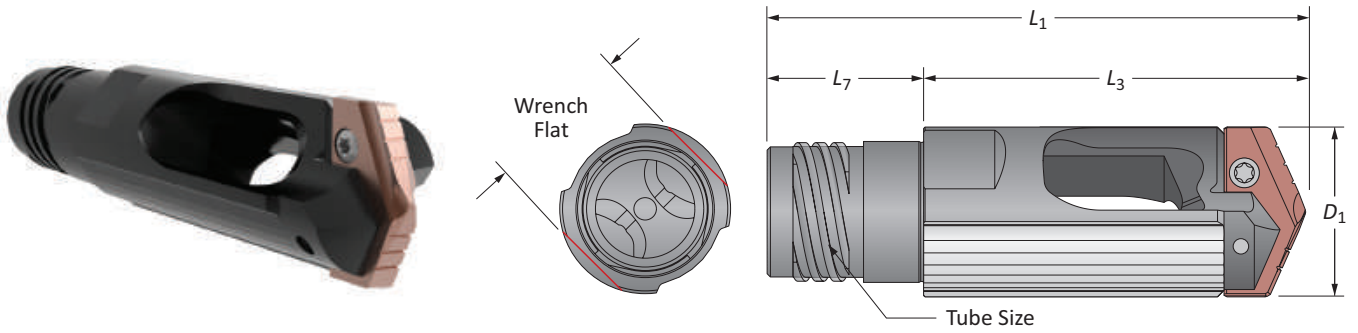

Tube Size	$D_1$	Holder			Part No.	T-A® Insert	Wrench Flat (mm)	
		$L_3$	$L_1$	$L_7$				
i	807	1.3801 - 1.4259	3-13/16	5-15/64	1-27/64	<b>BTA3-807-X.XXXX</b>	1C13H-XXXX-BT	30
	808	1.4260 - 1.5599	3-15/16	5-11/16	1-3/4	<b>BTA3-808-X.XXXX</b>	1C13H-XXXX-BT	32
	809	1.5600 - 1.6929	4-1/16	5-3/4	1-11/16	<b>BTA3-809-X.XXXX</b>	1C13H-XXXX-BT	36
	810	1.6930 - 1.8509	4-1/64	5-45/64	1-11/16	<b>BTA3-810-X.XXXX</b>	1C13H-XXXX-BT	41
	811	1.8510 - 1.8820	4-1/16	5-3/4	1-11/16	<b>BTA3-811-X.XXXX</b>	1C13H-XXXX-BT	41
m	807	35.06 - 36.22	96.8	132.8	36	<b>BTA3-807-XX.XX</b>	1C13H-XXXX-BT	30
	808	36.23 - 39.62	100.0	144.4	44.5	<b>BTA3-808-XX.XX</b>	1C13H-XXXX-BT	32
	809	39.63 - 43.00	103.1	146.2	43	<b>BTA3-809-XX.XX</b>	1C13H-XXXX-BT	36
	810	43.01 - 47.01	101.9	144.9	43	<b>BTA3-810-XX.XX</b>	1C13H-XXXX-BT	41
	811	47.02 - 47.80	103.2	146.2	43	<b>BTA3-811-XX.XX</b>	1C13H-XXXX-BT	41

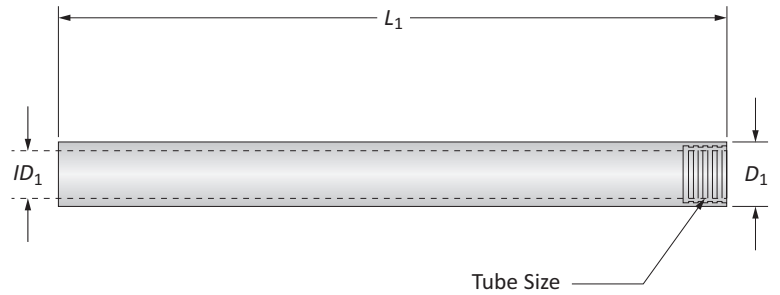

Tube Size	Tube			Part No.	
	$D_1$	$ID_1$	$L_1$		
i	807	1.181	0.787	102	<b>BTAT807-102</b>
	808	1.299	0.906	102	<b>BTAT808-102</b>
	809	1.417	0.984	102	<b>BTAT809-102</b>
	810	1.535	1.102	102	<b>BTAT810-102</b>
	811	1.693	1.220	102	<b>BTAT811-102</b>

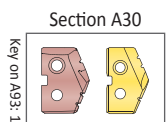

i = Imperial (in)  
m = Metric (mm)



SECTION

---

# B10

---

Wohlhaupter® Overview

# Wohlhaupter® High Precision Boring Systems

► Diameter Range: 0.016" - 128.150" (0.4mm - 3255mm)

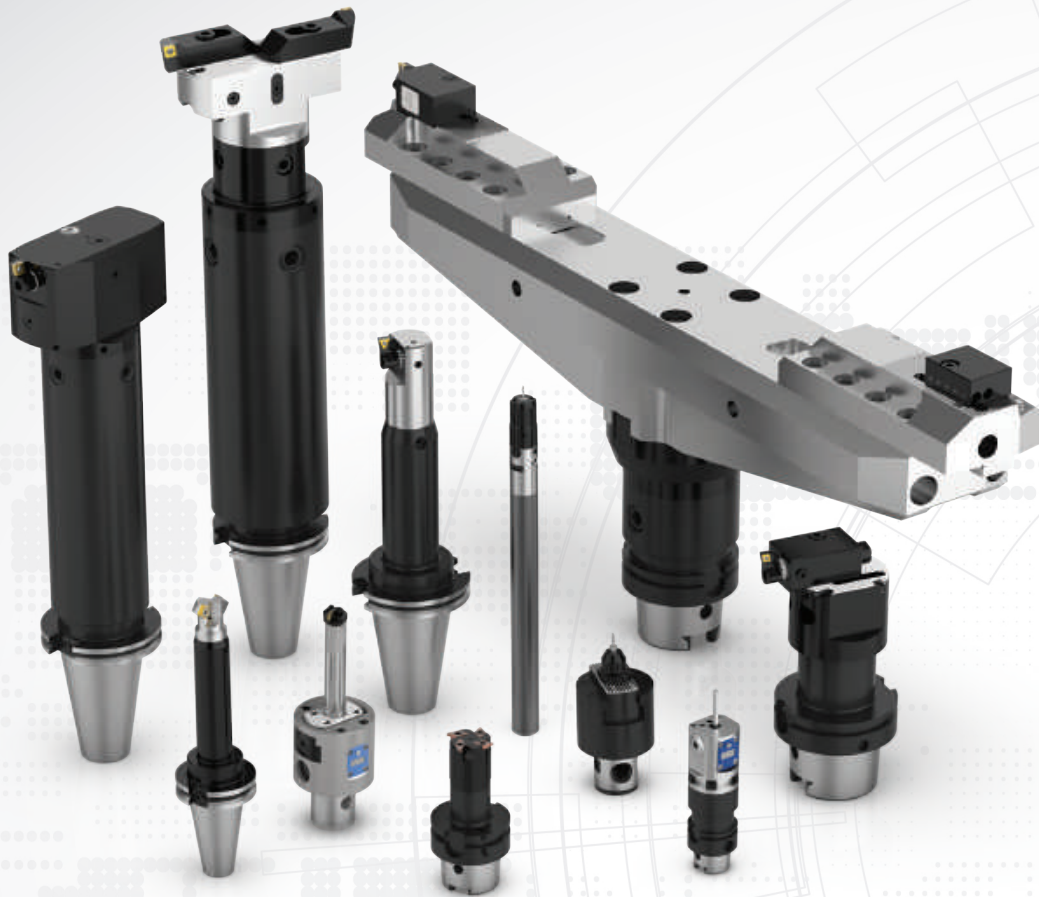

## Precision at Its Finest

From high precision to high production, Wohlhaupter has the right solution for your hole finishing applications. The Wohlhaupter product line offers the widest range of in-stock boring tools and the most precise and flexible modular systems on the market. With the most reliable digital readout tools and the ability to design and build special tools, Wohlhaupter is the solution for your boring challenges.

Also available to assist your application needs is the online tool modeling software, Tool-Architect. You can find your tooling, configure your system, and validate your selection all within the program. With the Wohlhaupter tool configurator, you will find the right tool with just a few clicks.

Rough and finish boring	Reliable digital readouts	Precise and flexible modular system
-------------------------	---------------------------	-------------------------------------

## Applicable Industries



Aerospace



Agriculture



Automotive



Firearms



General Machining



Oil & Gas



Renewable Energy

Your safety and the safety of others is very important. This catalog contains important safety messages. Always read and follow all safety precautions.



This triangle is a safety hazard symbol. It alerts you to potential safety hazards that can cause tool failure and serious injury.

When you see this symbol in the catalog, look for a related safety message that may be near this triangle or referred to in the nearby text.

There are safety signal words also used in the catalog. Safety messages follow these words.

### **WARNING**

**WARNING** (shown above) means that failure to follow the precautions in this message could result in tool failure and serious injury.

**NOTICE** means that failure to follow the precautions in this message could result in damage to the tool or machine but not result in personal injury.

**NOTE** and **IMPORTANT** are also used. These are important that you read and follow but are not safety-related.

Visit [www.alliedmachine.com](http://www.alliedmachine.com) for the most up-to-date information and procedures.

# Wohlhaupter® High Precision Boring Systems Contents

Introduction Information . . . . . 2 - 3

## Versatile Tooling Systems

PrimeBore . . . . . 4

VarioBore . . . . . 5

DigiBore . . . . . 6

Boring Kits . . . . . 7

## Boring Tools

249 (248) Boring Heads . . . . . 8

511 (510) Boring Heads . . . . . 8

320 (310) Boring Heads . . . . . 9

365 (364) Boring Heads . . . . . 9

565 (564) Boring Heads . . . . . 10

338 (337) Boring Heads . . . . . 10

538 (537) Boring Heads . . . . . 11

CombiLine . . . . . 11

Twin Cutter Roughing . . . . . 12

Grooving Tools . . . . . 12

Chamfering Tools . . . . . 13

Tool-Architect . . . . . 14 - 15



To find more information about the complete line of Wohlhaupter® High Precision Boring Systems, visit [www.wohlhaupter.com](http://www.wohlhaupter.com).

Additional information may also be found in the Wohlhaupter® MultiBore® System Tools catalog.

**(Literature Order Number: WOHLCAT)**



A  
DRILLING  
B  
BORING  
C  
REAMING  
D  
BURNISHING  
E  
THREADING  
X  
SPECIALS

# RUN THE GAMUT:

*from the most advanced to  
the toughest, we have the  
**solution** you need.*



Find the perfect solution



Decrease cost-per-hole



Reduce set-up times

*With a complete range of  
boring tooling from*

**WOHLHAUPTER®**

*you'll find exactly what  
you need to increase your  
productivity.*

## Versatile Tooling



Standard



Balance



Digital Balance



Combi-Line

*Plus many more*



THE  
**COMPLETE RANGE**  
Ø 0.016" - 128.15"  
(Ø 0.4mm - 3255mm)



- A DRILLING
- B BORING
- C REAMING
- D BURNISHING
- E THREADING
- X SPECIALS

Versatile Tooling

# PRIME BORE



PrimeBore Head

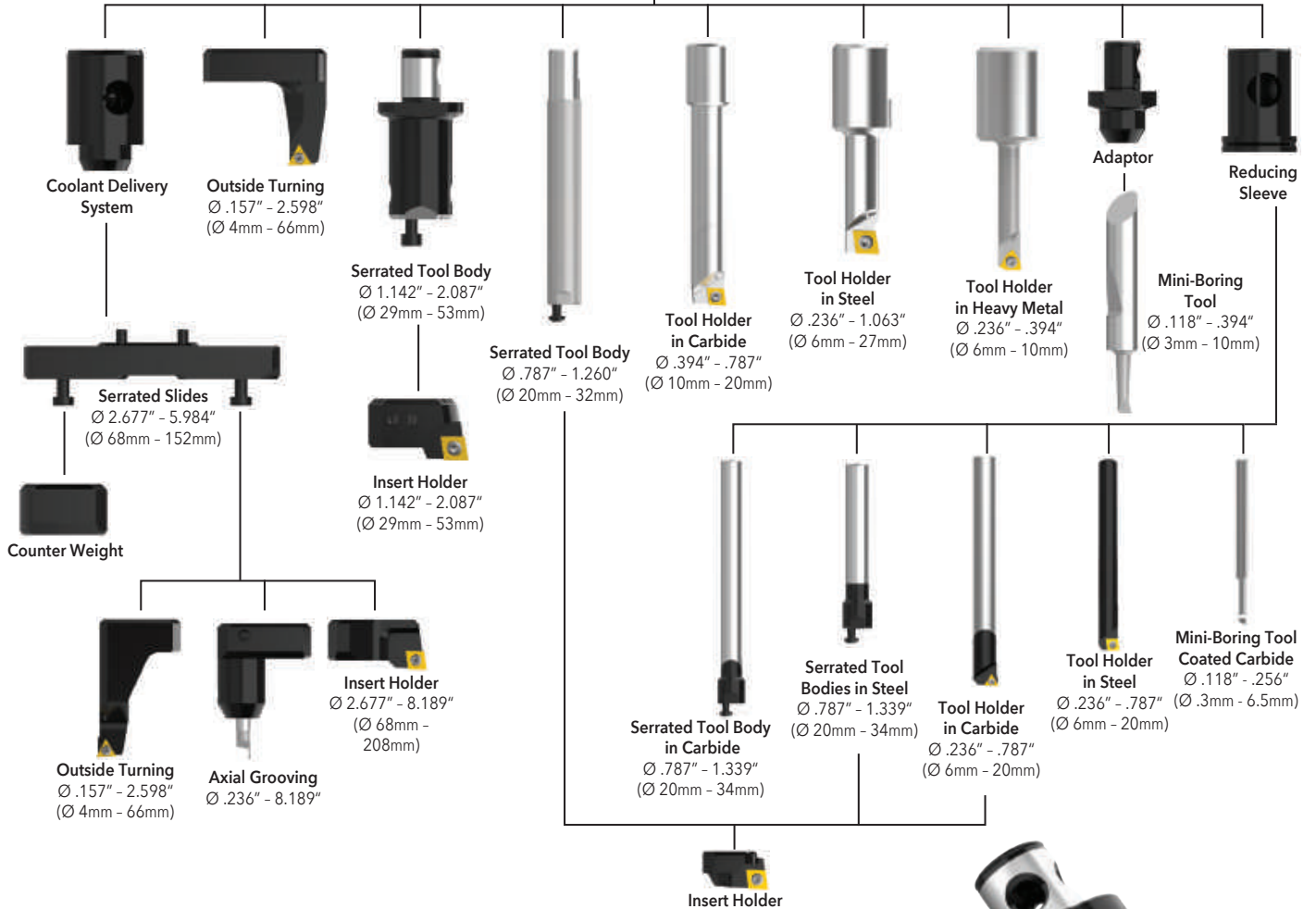

## OPERATION **VERSATILITY**

from **.118" to 8.189"** (3mm to 208mm)  
*plus outside turning*



A DRILLING  
 B BORING  
 C REAMING  
 D BURNISHING  
 E THREADING  
 X SPECIALS



Versatile Tooling

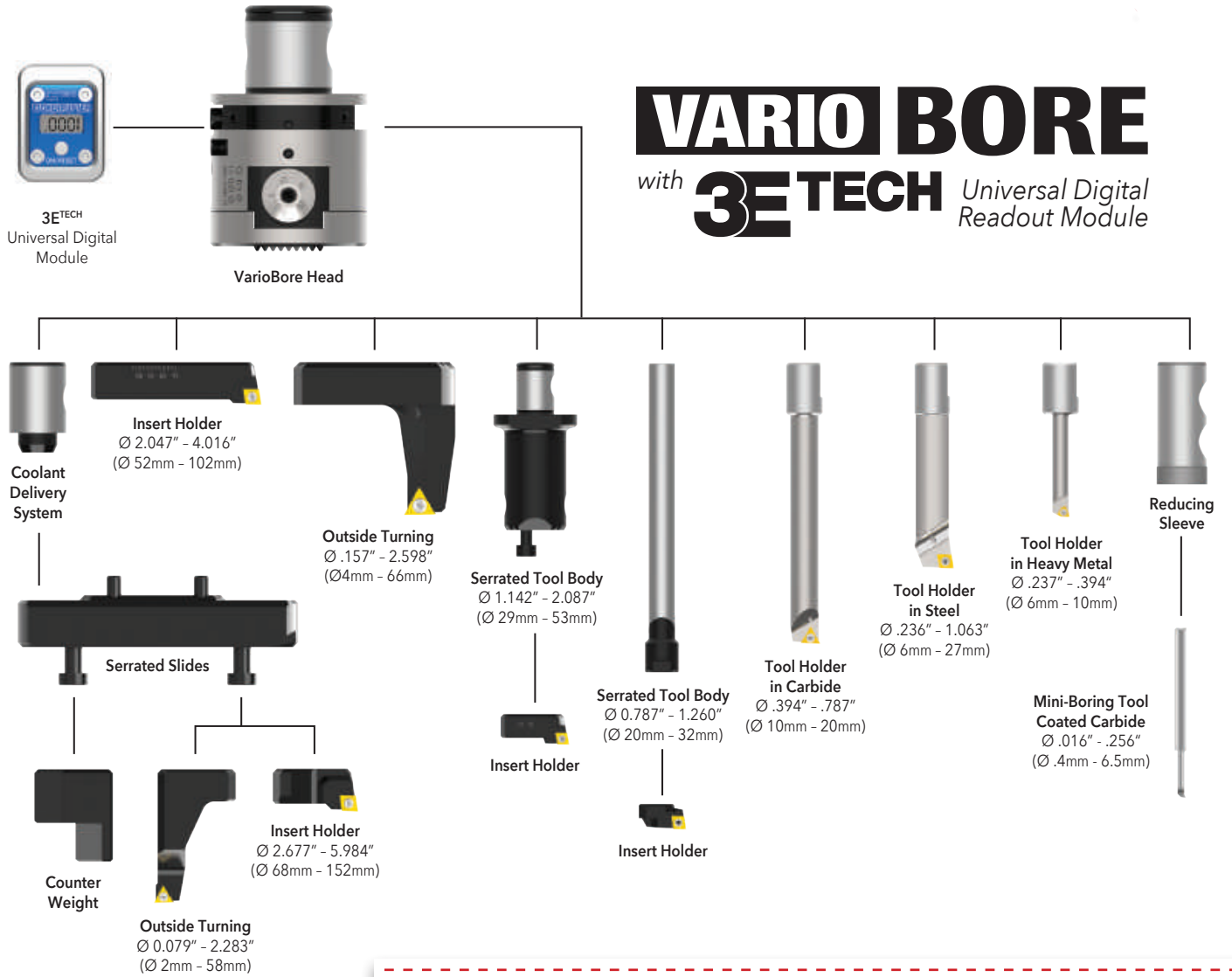

OPERATION **VERSATILITY**  
from **.016"** to **5.984"** (0.4mm to 152mm)  
*plus outside turning*



Versatile Tooling

A DRILLING  
B BORING  
C REAMING  
D BURNISHING  
E THREADING  
X SPECIALS

# DIGI BORE

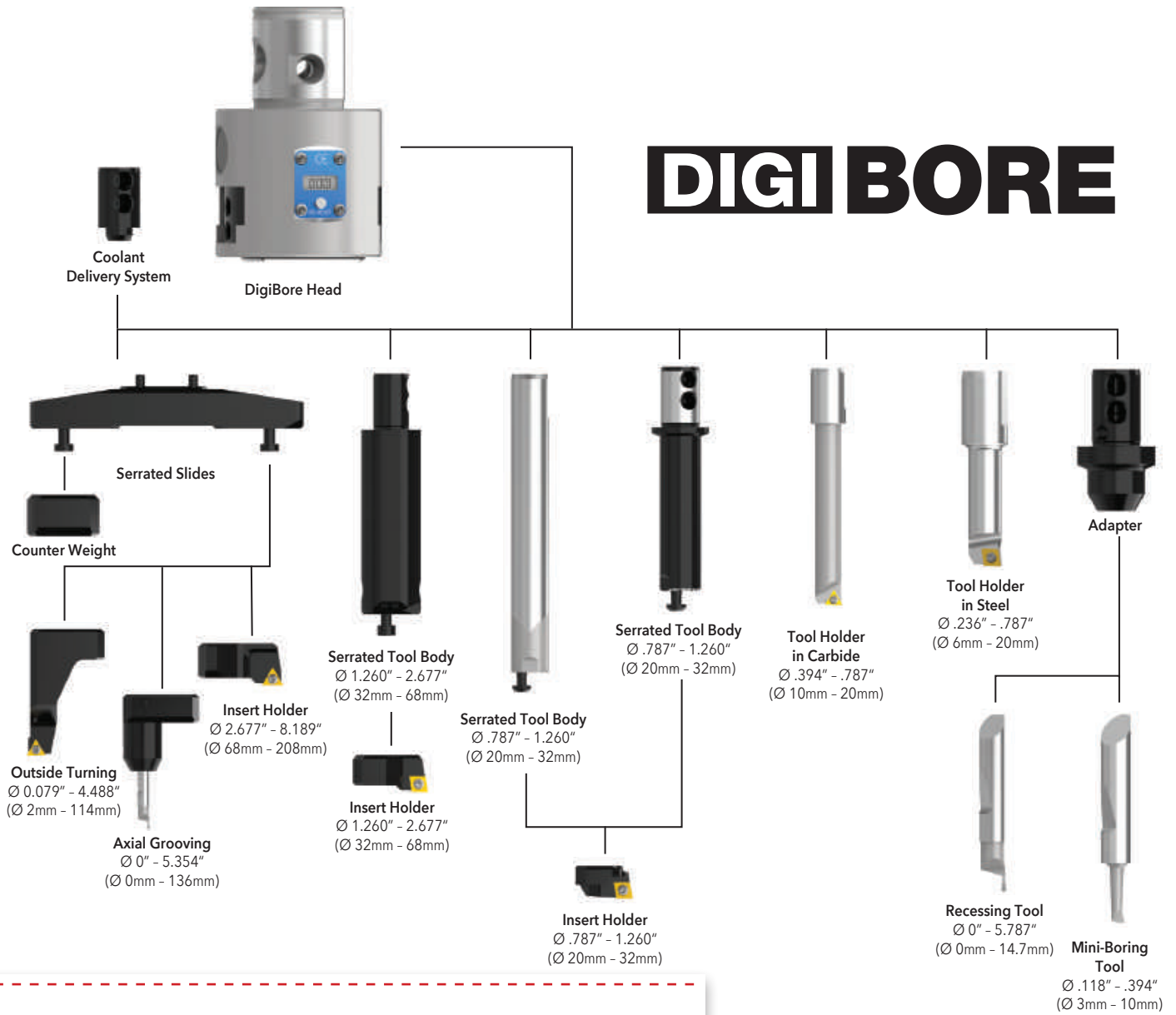

OPERATION **VERSATILITY**  
from **.118"** to **8.189"** (3mm to 208mm)  
*plus outside turning*



# WHY?

## WE HAVE A **KIT** FOR THAT

Kits aren't for everyone, but if you work on different projects from day to day, you need to **be prepared for the work tomorrow will bring.**

VERSATILE SETUPS AND IMPROVED READINESS

BROAD SELECTION OF DIAMETER RANGES

EASY CONVENIENT STORAGE AND ORGANIZATION

COST SAVINGS OVER BUYING INDIVIDUAL COMPONENTS

### DIGI BORE

Ultimate Accuracy



- Kits are available in imperial and metric
- Internal digital display for 0.0001" (0.002mm) adjustments
- Internal automatic balancing
- Standard ISO insert CC..0602..

*Additional kits available, please inquire*



**.394" - 1.260"**  
(10mm - 32mm)

**i** # 104 061 | \$3,526.52  
**m** # 103 061



**1.260" - 2.677"**  
(32mm - 68mm)

**i** # 104 063 | \$3,374.56  
**m** # 103 063



**2.677" - 5.984"**  
(68mm - 152mm)

**i** # 104 065 | \$3,442.68  
**m** # 103 065



**3.780" - 8.189"**  
(96mm - 208mm)

**i** # 104 081 | \$3,819.96  
**m** # 103 081

### VARIO BORE

Versatile Accuracy

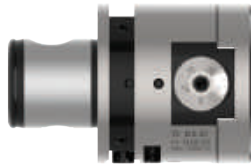

- Kits are available in imperial and metric
- Vernier scale for 0.0001" (0.002mm) adjustments
- **3E TECH** digital readout module compatible\*
- Standard ISO insert CC..0602..

*Additional kits available, please inquire*



**.394" - 1.181"**  
(10mm - 30mm)

**i** # 104 046 | \$2,068.49  
**m** # 103 046



**.394" - 4.016"**  
(10mm - 102mm)

**i** # 104 048 | \$3,365.39  
**m** # 103 048



\*Sold separately

#### Portable Digital Display

Use with multiple boring heads equipped with a **3E TECH** port

**i** # 563 010 | \$423.13  
**m** # 536 010



#### MASTER SHANKS WITH MVS (sold separately)

CAT | BT | HSK | PSC | NMTB | MT

**Boring Tools**

# 249 (248) Boring Head

Ø 0.118" - 1.189" (3mm - 30.2mm)



**Features**

- Compact construction
- 0.0005" (0.010mm) dial adjustment on diameter
- Variable length adjustment with accessories
- Coolant through



# 511 (510) Boring Head

Ø 0.016" - 0.472" (0.4mm - 12.0mm)



**Features**

- 0.0001" (0.02mm) digital adjustment on diameter
- Lengths and diameters achieved through the use of boring tools and bars
- 4 balancing elements for precision
- Coolant through



A DRILLING  
B BORING  
C REAMING  
D BURNISHING  
E THREADING  
X SPECIALS

## 320 (310) Boring Head

Ø 0.787" - 8.070" (20mm - 205mm)



### Features

- 0.0001" (0.002mm) Vernier adjustment on diameter
- Tools with Ø 0.787" - 4.05" (20mm - 103mm) are made of steel
- Tools with Ø 3.937" - 8.070" (100mm - 205mm) are made of aluminum
- Insert holder can be rotated for reverse machining
- Coolant through
- Can be used with AluLine serrated slides for large diameter OD turning



## 365 (364) Boring Head *Balance*

Ø 0.787" - 8.070" (20mm - 205mm)



### Features

- 0.0001" (0.002mm) Vernier adjustment on diameter
- Internal auto-balancing
- Tools with Ø 0.787" - 2.579" (20mm - 65.5mm) are made of steel
- Tools with Ø 2.559" - 8.070" (65mm - 205mm) are made of aluminum
- Insert holder can be rotated for reverse machining
- Coolant through
- Can be used with AluLine serrated slides for large diameter OD turning



**Boring Tools**

A  
DRILLING  
B  
BORING  
C  
REAMING  
D  
URNISHING  
E  
HREADING  
X  
PECIALS

# 565 (564) Boring Head *Balance* **DIGITAL**

Ø 1.968" - 8.070" (50mm - 205mm)



**Features**

- 0.0001" (0.002mm) digital adjustment on diameter
- Internal auto-balancing
- Tools with Ø 1.968" - 2.579" (50mm - 65.5mm) are made of steel
- Tools with Ø 2.559" - 8.070" (65mm-205mm) are made of aluminum
- Coolant through
- Insert holder can be rotated for reverse machining
- Can be used with AluLine serrated slides for large diameter OD turning



# 338 (337) Boring Head

Ø 3.937" - 128.150" (100mm - 3255mm)



**Features**

- 0.0001" (0.002mm) Vernier adjustment on diameter
- Aluminum light-weight construction
- Ø 3.937" - 8.071" (100mm - 205mm) on serrated tool body
- Ø 7.870" - 128.150" (200mm - 3255mm) on AluLine slides
- Insert holder can be rotated for reverse machining



# 538 (537) Boring Head

Ø 3.937" - 128.15" (100mm - 3255mm)

## Features

- 0.0001" (0.002mm) digital adjustment on diameter
- Aluminum light-weight construction
- Ø 3.937" - 8.071" (100mm - 205mm) on serrated tool bodies
- Ø 7.870" - 128.150" (200mm - 3255mm) on AluLine slides
- Insert holders can be rotated for reverse machining

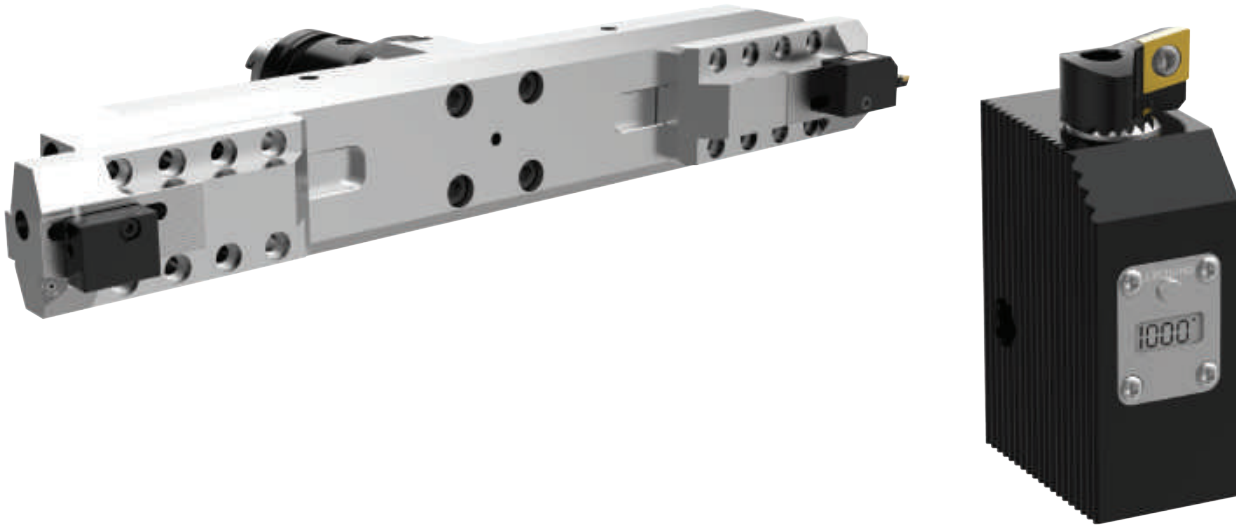

## COMBI LINE

Ø 0.965" - 7.913" (24.5mm - 201mm)

*A true rough and finish 1-pass boring tool*

## Features

- Rough and finish boring in one operation
- 0.0001" (0.002mm) Vernier adjustment on finishing insert holder
- Available in height displaced and same level cutting
- Coolant through
- Standard ISO inserts

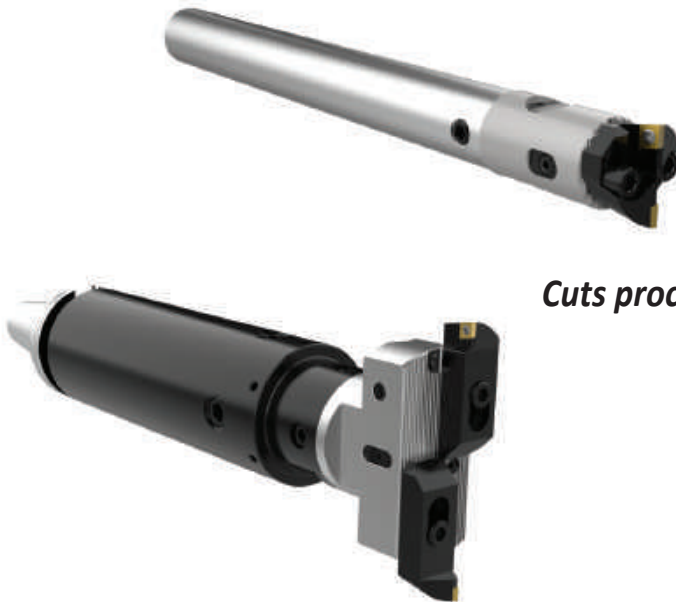

*Cuts processing time in half!*



Boring Tools

# Twin Cutter Roughing

Ø 3.937" - 128.15" (100mm - 3255mm)

**Features**

- Available with cylindrical shanks or MVS shanks
- Same level to double feed
- Height displacement to double material removal
- Coolant through
- Standard ISO inserts

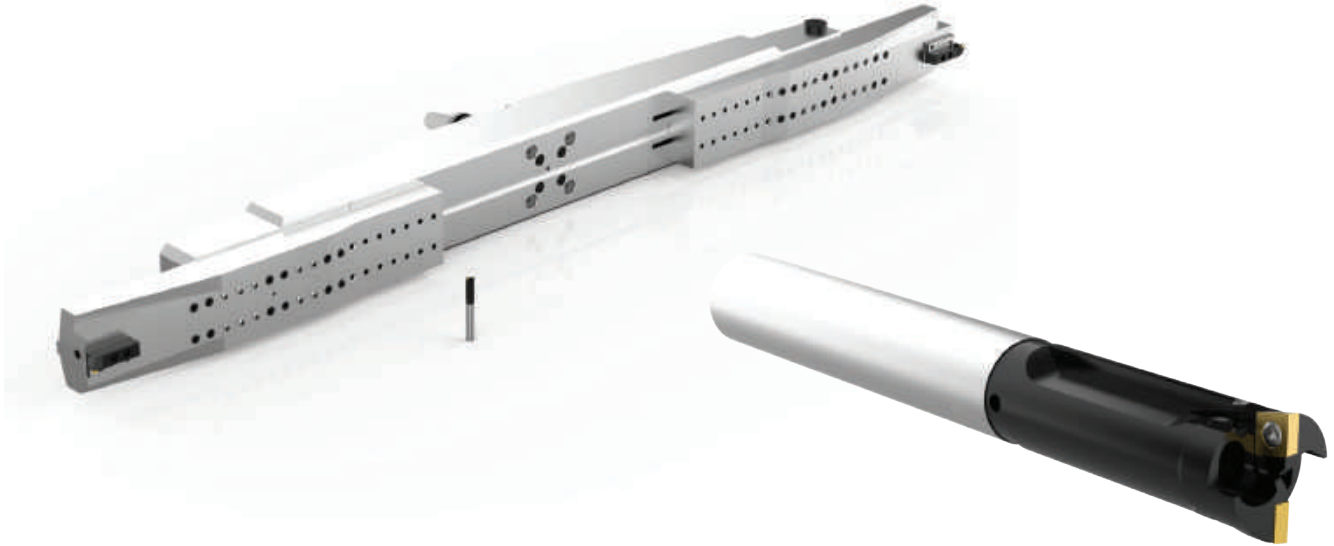

# Grooving Tools



**Grooving Tools for Circular Milling**  
Ø > 0.787" (20mm)

- Groove widths from 0.050" (1.27mm)
- 2 - 8 inserts (depending on diameter)
- 2-sided inserts
- Coolant through



**Axial Grooving Tools**  
0.787" - 8.070 (20mm - 205mm)

- Groove widths from 0.137" - 0.295" (3.5mm - 7.5mm)
- 3-sided inserts
- Utilizes the same serrated tool body as other roughing tools

A DRILLING  
B BORING  
C REAMING  
D BURNISHING  
E THREADING  
X SPECIALS



# Chamfering Tools

$\varnothing > 0.748''$  (19mm)

## Features

- Utilizes the same serrated tool holder as other roughing tools
- Chamfer angle of 15°, 20°, 30°, and 45°
- Coolant through
- Standard ISO inserts



To find more information about the complete line of Wohlhaupter® High Precision Boring Systems, visit [www.wohlhaupter.com](http://www.wohlhaupter.com).

Additional information may also be found in the Wohlhaupter® MultiBore® System Tools catalog.

**(Literature Order Number: WOHLCAT)**

# Tool-Architect

www.tool-architect.com



## Design Your Own Solutions

Tool-Architect is a configurator for Wohlhaupter modular tooling systems that allows customers to virtually build their own solution. This online-based simulator puts the entire Wohlhaupter inventory at your fingertips. It provides a digital bank of every individual part that Wohlhaupter manufactures in either inch or metric measurements.

Once you select a component, you will be guided by a series of user-friendly prompts to select the next components until you have built your tooling system. Throughout the process, you can monitor the size of your custom tool and ensure what you're building matches your real-life specifications. Once a complete system is virtually assembled, the program will render the tool in either a 2D or 3D drawing to view on your device. Each project can be saved for future editing.

Designing your tools with Tool-Architect saves you time and allows you to instantly obtain the right tool for the job.

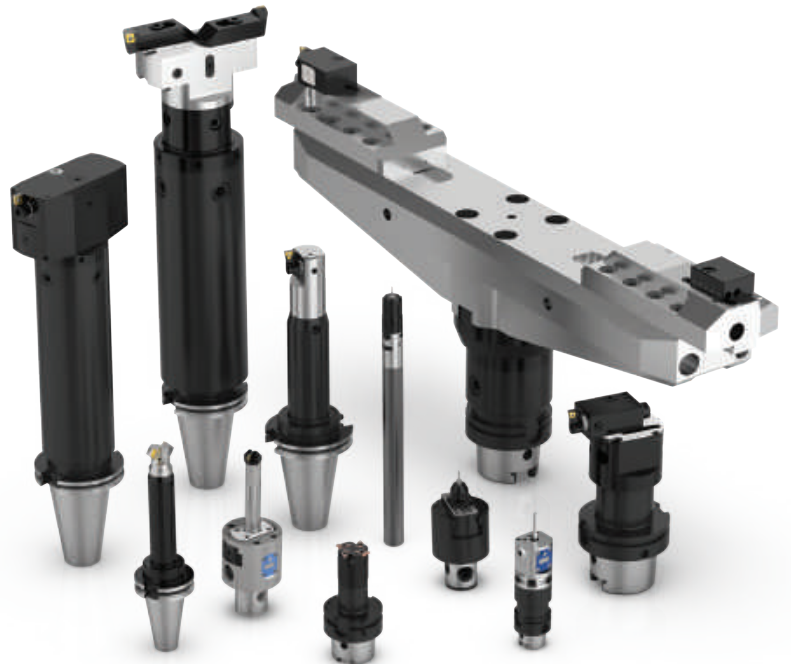

Design anytime from anywhere.  
Available online 24/7.

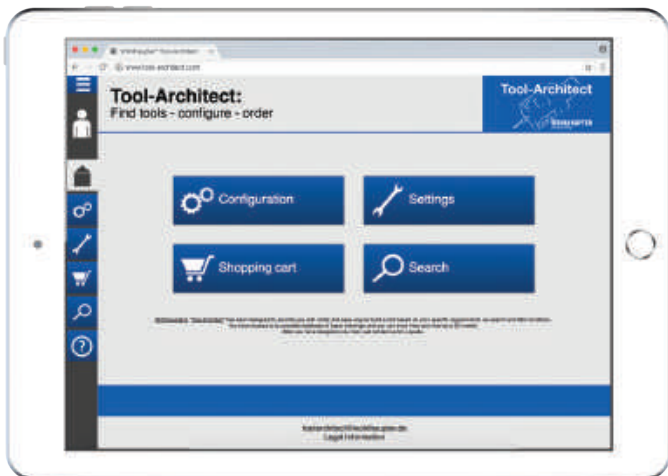

### Find the right Wohlhapter® solution for your application

1. Configure your complete tool assembly
2. Compile an order list to be quoted
3. Search and quickly find components using various criteria
4. Adjust your language and measurement preferences



Find specific item details and download 2D and 3D drawings

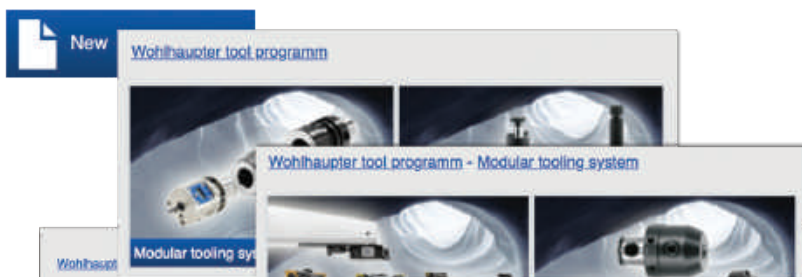

Quickly navigate through the entire Wohlhapter product inventory to find the right tooling solution for your job

Order No.	Description	Images	Order No.	Description	Images	Order No.	Description	Images	Order No.	Description	Images	Order No.	Description	Images
248011	Precision boring tool		248012	Precision boring tool M8x1		248013	Precision boring tool M8x1		248021	Precision boring tool M8x1		248022	Precision boring tool M8x1	
248023	Precision boring tool M8x1		310011	Precision boring tool MVS25-14										





SECTION

---

# B20

---

Criterion® Boring Systems

# Criterion® Modular Boring Systems

MBS | CBS | MDS | Cri-Bore® | Large Cri-Bore® | CB Style



## CRITERION®

### Boring holes doesn't have to be boring.

Criterion modular boring systems bring speed, tolerance, toughness, and versatility to your boring applications.

The MBS finish boring tool is ideal for small diameter bores and high spindle speeds to bore quickly and efficiently.

The Cri-Bore boring system is designed for finish boring applications and can be used for extremely tight tolerances. When the tolerance is tight, the Cri-Bore can be adjusted in 0.00005" (fifty-millionths).

The versatile CB style boring heads are available in both micro adjusting and standard. Made for maximum toughness, the CB style boring head can produce a wide range of diameters.

Your safety and the safety of others is very important. This catalog contains important safety messages. Always read and follow all safety precautions.



This triangle is a safety hazard symbol. It alerts you to potential safety hazards that can cause tool failure and serious injury.

When you see this symbol in the catalog, look for a related safety message that may be near this triangle or referred to in the nearby text.

There are safety signal words also used in the catalog. Safety messages follow these words.

#### **WARNING**

**WARNING** (shown above) means that failure to follow the precautions in this message could result in tool failure and serious injury.

**NOTICE** means that failure to follow the precautions in this message could result in damage to the tool or machine but not result in personal injury.

**NOTE** and **IMPORTANT** are also used. These are important that you read and follow but are not safety-related.

Visit [www.alliedmachine.com](http://www.alliedmachine.com) for the most up-to-date information and procedures.



Aerospace



Agriculture



Automotive



Firearms



Renewable  
Energy

# Criterion® Modular Boring Systems Contents

## Reference Icons

The following icons will appear throughout the catalog to help you navigate between products.

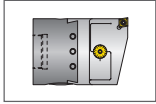

**Boring Heads - Insert Holders**  
Micro adjusting boring heads that use inserts for cutting

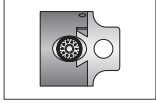

**Boring Heads - Boring Bar Holders**  
Standard and micro adjusting boring heads that use boring bars for cutting

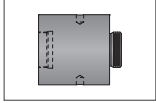

**Head-to-Shank Adapters**  
Extensions and reducers that attach the boring head to the shank

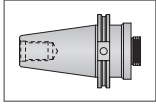

**Shanks**  
A variety of shanks for different machines



**Setup / Assembly Information**  
Detailed instructions and information regarding the corresponding part(s)

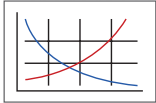

**Recommended Cutting Data**  
Speed and feed recommendations for optimum and safe boring

**MBS Finish Boring Tools** . . . . . 2 - 6

**CBS Finish Boring Tools** . . . . . 8 - 11

**MDS Finish Boring Tools** . . . . . 12 - 14

**Cri-Bore® Micro Adjusting Finish Boring Heads** . . . . . 16 - 18

**Large Cri-Bore® Finish Boring / OD Turning System** . . . . . 20 - 25

**CB Style Versatile Finish Boring Heads** . . . . . 26 - 45

**Intermediate Modules** . . . . . 48 - 49

**Master Shanks** . . . . . 50 - 53

**Parts & Accessories** . . . . . 54 - 55

**Technical Information** . . . . . 56 - 58

## Guidelines / Troubleshooting

Guidelines to Not Exceed Recommended Length . . . . . 60

Calculating Tool Assembly Weight . . . . . 61

**Recommended Cutting Data** . . . . . 62 - 63

Series	Bore Diameter Range	
	Imperial (inch)	Metric (mm)
<b>MBS Finish Boring Tools</b>	0.050" - 0.750"	–
<b>CBS Finish Boring Tools</b>	0.050" - 0.750"	–
<b>MDS Finish Boring Tools</b>	0.710" - 1.280"	18.00mm - 33.00mm
<b>Cri-Bore® Micro Adjusting Finish Boring Heads</b>	1.050" - 5.065"	27.00mm - 128.00mm
<b>Large Cri-Bore® Finish Boring / OD Turning System</b>	5.000" - 12.125"	127.00mm - 308.00mm
<b>CB Style Versatile Finish Boring Heads</b>	0.250" - 21.500"	–



# WE KNOW

SPEED MATTERS

## MBS Finish Boring Tool

Ideal for small diameter bores and high spindle speeds

Compact design great for live tooling

Cylindrical shank can be dropped into existing tool holders





## MBS Finish Boring Tool

Bore Diameter Range: 0.050" - 0.750"

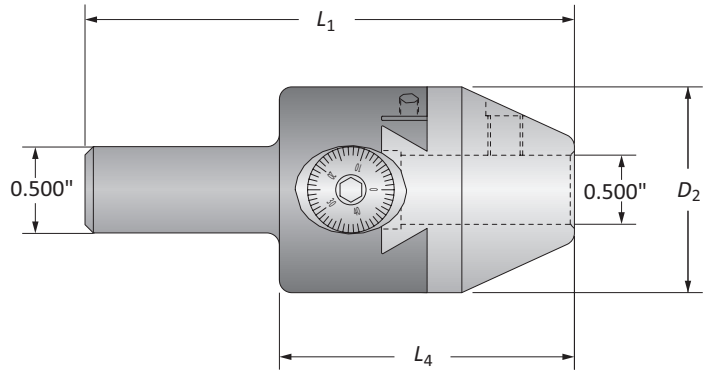

Boring Range	Boring Head			Weight	Part No.
	$L_1$	$L_4$	$D_2$		
<b>i</b> 0.050 - 0.750	3.500	2.125	1.500	0.900 (lbs)	<b>MBS0500B</b>

Imperial (in) = 0.001" adjustment on diameter

**NOTE:** Max spindle speed: 7,000 RPM at 0 radial offset

B20: 62 - 63

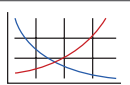

Key on B20: 1

B20: 57 - 59



**i** = Imperial (in)  
**m** = Metric (mm)

**IMPORTANT:** Max spindle speed refers to maximum possible speed for individual boring head and is not a recommended parameter. Refer to page B20: 62 for recommended application specific parameters. Factory technical assistance is available for your specific applications through our Application Engineering department.  
ext: 7611 | email: [appeng@alliedmachine.com](mailto:appeng@alliedmachine.com)

## Mini Coated Boring Tools

Bore Diameter Range: 0.050" - 0.275"

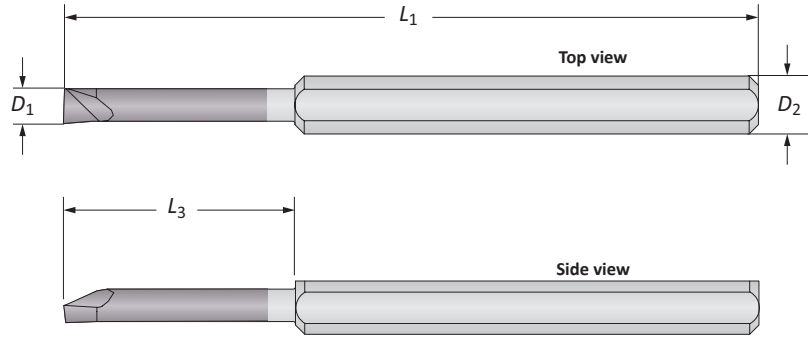

### Mini Coated Boring Bars

Min. Boring Diameter	Boring Bar				Weight	Part No.
$D_1$	$L_3$	$L_1$	$D_2$			
0.050	0.300	1.500	0.125*	0.010 (lbs)	<b>0050GA</b>	
0.060	0.300	1.500	0.125*	0.010 (lbs)	<b>0060GA</b>	
0.080	0.500	1.500	0.125*	0.010 (lbs)	<b>0080GA</b>	
0.100	0.600	1.500	0.125*	0.010 (lbs)	<b>0100GA</b>	
0.110	0.700	1.500	0.125*	0.010 (lbs)	<b>0110GA</b>	
0.120	0.750	2.500	0.250*	0.020 (lbs)	<b>0120HA</b>	
0.140	0.750	2.500	0.250*	0.020 (lbs)	<b>0140HA</b>	
0.160	0.875	2.500	0.250*	0.020 (lbs)	<b>0160HA</b>	
0.180	1.125	2.500	0.250*	0.020 (lbs)	<b>0180HA</b>	
0.200	1.250	2.500	0.250*	0.020 (lbs)	<b>0200HA</b>	

\*Reducing sleeve required

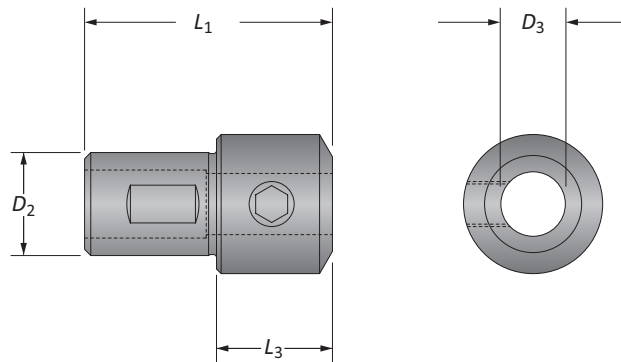

### Reducing Sleeves

Reducing Sleeve					
$D_3$	$D_2$	$L_1$	$L_3$	Weight	Part No.
0.125	0.500	2.000	0.220	0.100 (lbs)	<b>BTH-01250500</b>
0.250	0.500	1.312	-	0.050 (lbs)	<b>BTH-02500500</b>

B20: 62 - 63

B20: 57 - 59

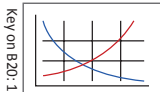

**i** = Imperial (in)  
**m** = Metric (mm)



## Boring Bars

Bore Diameter Range: 0.250" - 0.750"

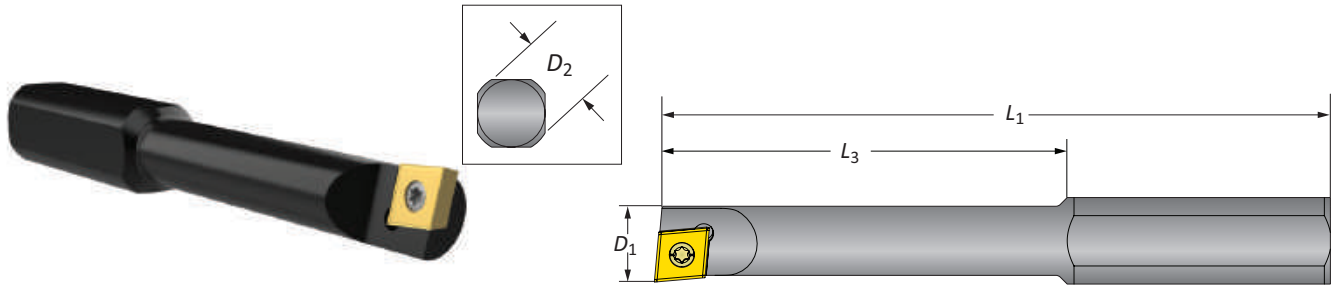

### Steel Boring Bars | Bore Diameter Range: 0.250" - 0.750"

Min. Boring Diameter	Boring Bar			Weight	Insert Form	Part No.
	$D_1$	$L_3$	$L_1$			
0.250	1.062	2.500	0.500	0.080 (lbs)	WBGX0301..	<b>0250B</b>
0.312	1.437	2.750	0.500	0.080 (lbs)	WBGX0301..	<b>0312B</b>
0.375	1.750	3.062	0.500	0.100 (lbs)	WBGX0301..	<b>0375B</b>
0.437	2.062	3.375	0.500	0.110 (lbs)	CC..215..	<b>0437B</b>
0.500	2.187	3.500	0.500	0.140 (lbs)	CC..215..	<b>0500B</b>

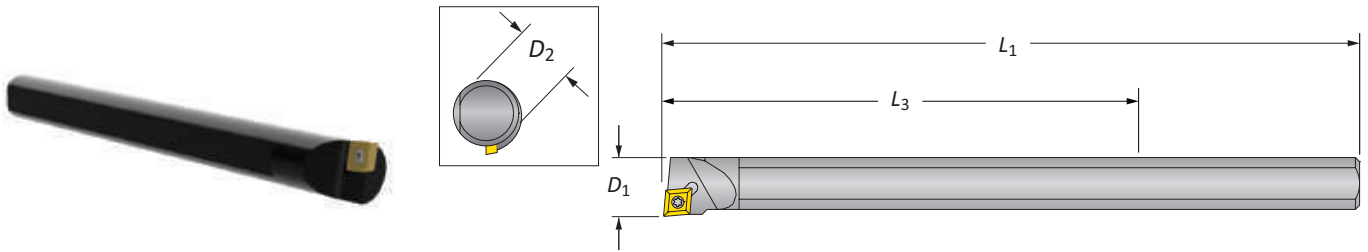

### Heavy Metal Boring Bars | Bore Diameter Range: 0.365" - 0.750"

Min. Boring Diameter	Boring Bar			Weight	Insert Form	Part No.
	$D_1$	$L_3$	$L_1$			
0.365	2.250	4.000	0.312*	0.080 (lbs)	CC..215..	<b>0365HM</b>
0.550	3.250	6.000	0.500	0.300 (lbs)	CC..215..	<b>0550BHM</b>

\*Reducing sleeve required

### Carbide Boring Bars | Bore Diameter Range: 0.625" - 0.750"

Min. Boring Diameter	Boring Bar			Weight	Insert Form	Part No.
	$D_1$	$L_3$	$L_1$			
0.625	4.500	8.000	0.500	0.410 (lbs)	CC..215..	<b>0625BCS</b>

### Reducing Sleeves

Reducing Sleeve				Weight	Part No.
	$D_3$	$D_2$	$L_1$		
0.312	0.500	1.312	-	0.040 (lbs)	<b>BTH-03120500</b>
0.375	0.500	1.312	-	0.030 (lbs)	<b>BTH-03750500</b>

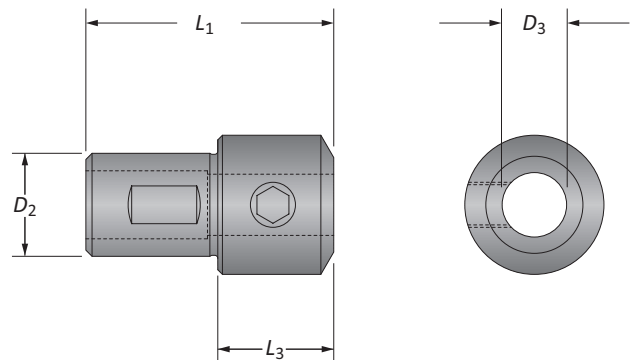

B20: 62 - 63

B20: 57 - 59

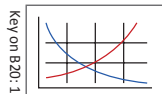

i = Imperial (in)  
m = Metric (mm)  
 Inserts sold separately

A DRILLING  
 B BORING  
 C REAMING  
 D BURNISHING  
 E THREADING  
 X SPECIALS

A  
DRILLING  
  
B  
BORING  
  
C  
REAMING  
  
D  
BURNISHING  
  
E  
THREADING  
  
X  
SPECIALS

## Boring Inserts

Trigon | 80° Diamond

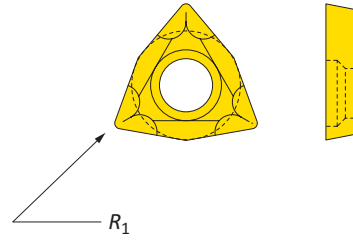

### Coated Trigon Insert

		Insert		Part No.
Insert Form		$R_1$		
<b>i</b>	WBGX0301..	0.004	WBGX030101	

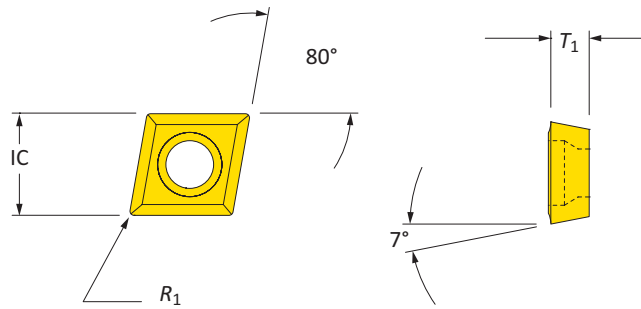

### Coated 80° Diamond Insert

		Insert			Part No.
Insert Form		IC	$T_1$	$R_1$	
<b>i</b>	CC..215..	0.250	0.094	0.008	CCMT060202

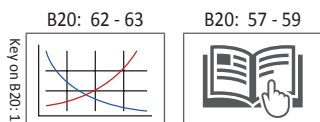

**i** = Imperial (in)  
**m** = Metric (mm)  
Inserts sold separately





# WE KNOW

REACH MATTERS

## CBS Finish Boring Tool

Ease the stress of reaching past fixturing

Ideal for small diameter bores with long overhangs

Cylindrical shank can be dropped into existing endmill (side-lock) holders



## CBS Finish Boring Tool

Bore Diameter Range: 0.050" - 0.750"

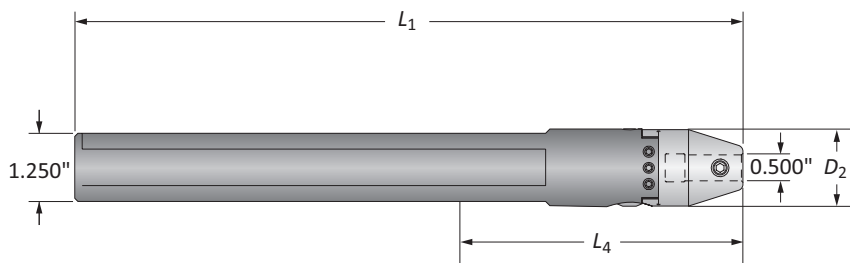

Boring Range	Boring Head			Weight	Part No.
	$L_1$	$L_4$	$D_2$		
<b>i</b> 0.050 - 0.750	10.600	8.320	1.250	3.100 (lbs)	<b>CBS1250B</b>

Imperial (in)= 0.001" adjustment on diameter

**NOTE:** Max spindle speed: 3,500 RPM at 0 radial offset

B20: 62 - 63

B20: 57 - 59

Key on B20: 1

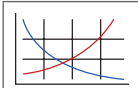

**i** = Imperial (in)  
**m** = Metric (mm)

**IMPORTANT:** Max spindle speed refers to maximum possible speed for individual boring head and is not a recommended parameter. Refer to page B20: 62 for recommended application specific parameters. Factory technical assistance is available for your specific applications through our Application Engineering department.  
ext: 7611 | email: [appeng@alliedmachine.com](mailto:appeng@alliedmachine.com)

## Mini Coated Boring Tools

Bore Diameter Range: 0.050" - 0.275"

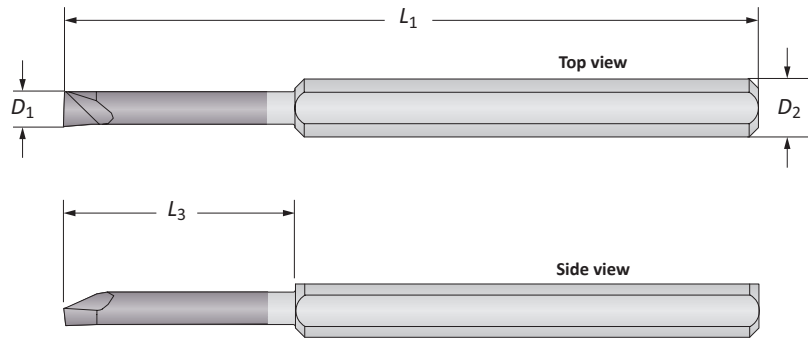

### Mini Coated Boring Tools

Min. Boring Diameter	Boring Bar				Weight	Coated Part No.
	$D_1$	$L_3$	$L_1$	$D_2$		
0.050	0.300	1.500	0.125*	0.010 (lbs)	0050GA	
0.060	0.300	1.500	0.125*	0.010 (lbs)	0060GA	
0.080	0.500	1.500	0.125*	0.010 (lbs)	0080GA	
0.100	0.600	1.500	0.125*	0.010 (lbs)	0100GA	
0.110	0.700	1.500	0.125*	0.010 (lbs)	0110GA	
0.120	0.750	2.500	0.250*	0.020 (lbs)	0120HA	
0.140	0.750	2.500	0.250*	0.020 (lbs)	0140HA	
0.160	0.875	2.500	0.250*	0.020 (lbs)	0160HA	
0.180	1.125	2.500	0.250*	0.020 (lbs)	0180HA	
0.200	1.250	2.500	0.250*	0.020 (lbs)	0200HA	

\*Reducing sleeve required

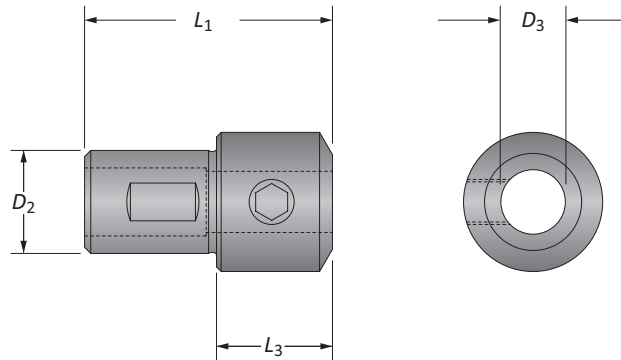

### Reducing Sleeves

	Reducing Sleeve				Weight	Part No.
	$D_3$	$D_2$	$L_1$	$L_3$		
0.125	0.500	2.000	0.220	0.100 (lbs)	BTH-01250500	
0.250	0.500	1.312	-	0.050 (lbs)	BTH-02500500	
0.375	0.500	1.312	-	0.030 (lbs)	BTH-03750500	

B20: 62 - 63

B20: 57 - 59

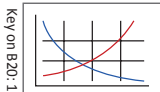

**i** = Imperial (in)  
**m** = Metric (mm)





## Steel Boring Bars | Boring Inserts

Bore Diameter Range: 0.250" - 0.750"

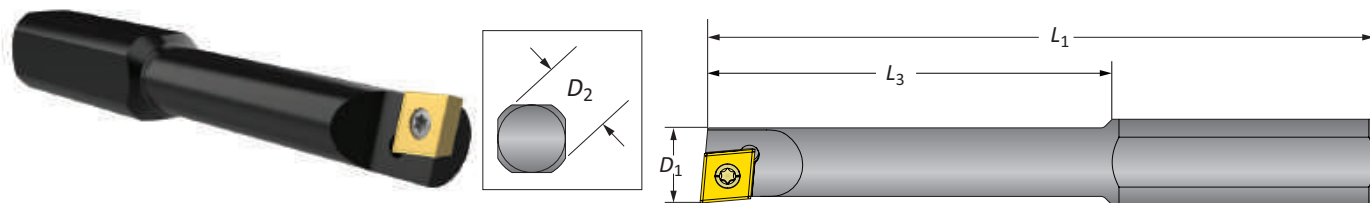

### Steel Boring Bars

Min. Boring Diameter	Boring Bar				Weight	Insert Form	Part No.
	$D_1$	$L_3$	$L_1$	$D_2$			
0.250	1.062	2.500	0.500	0.080 (lbs)	WBGX0301...	<b>0250B</b>	
0.312	1.437	2.750	0.500	0.080 (lbs)	WBGX0301...	<b>0312B</b>	
0.375	1.750	3.062	0.500	0.100 (lbs)	WBGX0301...	<b>0375B</b>	
0.437	2.062	3.375	0.500	0.110 (lbs)	CC..215..	<b>0437B</b>	
0.500	2.187	3.500	0.500	0.140 (lbs)	CC..215..	<b>0500B</b>	

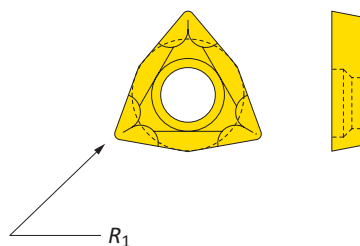

### Coated Trigon Insert

Insert Form	Insert		Part No.
	$R_1$		
WBGX0301...	0.004		<b>WBGX030101</b>

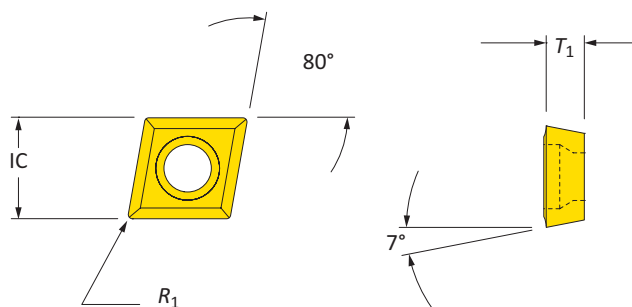

### Coated 80° Diamond Insert

Insert Form	Insert			Part No.
	$IC$	$T_1$	$R_1$	
CC..215..	0.250	0.094	0.008	<b>CCMT060202</b>

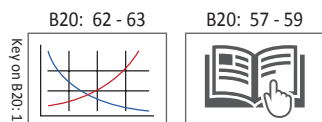

i = Imperial (in)  
m = Metric (mm)  
 Inserts sold separately

A DRILLING  
 B BORING  
 C REAMING  
 D BURNISHING  
 E THREADING  
 X SPECIALS



# WE KNOW CONVENIENCE MATTERS

## MDS Finish Boring Tool

Compact design and rugged insert holder make it one of the toughest boring tools under 1.000" (25.4mm) diameter

Cylindrical shank can be dropped into existing endmill (side-lock) holders

Available in both imperial (in) and metric (mm) versions

## MDS Finish Boring Tools

Bore Diameter Range: 0.710" - 1.280" (18.00mm - 33.00mm)

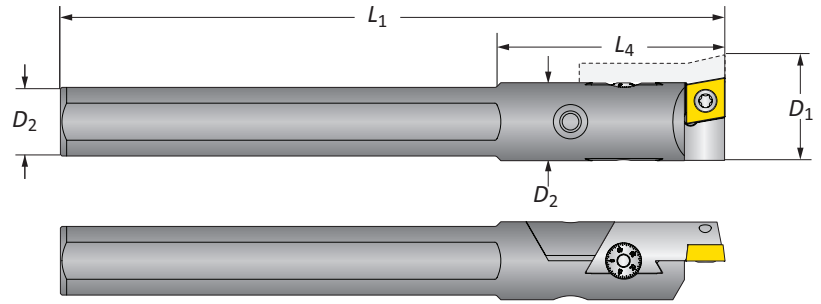

	Boring Range		Shank Diameter		Boring Head		Weight	Insert Form	Part No.
	$D_1$	$D_2$	$L_1$	Max $L_4$					
i	0.710 - 0.960	0.625	5.250	3.386	0.400 (lbs)	CC..215..	<b>MDS0625</b>		
	0.890 - 1.280	0.750	6.310	4.435	0.700 (lbs)	CC..325..	<b>MDS0750</b>		
m	18.00 - 24.25	16.00	133.00	85.37	0.18 (kg)	CC..0602..	<b>MDS16M</b>		
	22.00 - 33.00	20.00	160.00	112.37	0.32 (kg)	CC..09T3..	<b>MDS20M</b>		

Imperial (in) = 0.001" adjustment on diameter

Metric (mm) = 0.020mm adjustment on diameter

**NOTE:** Max spindle speed: 1,000 SFM (305 M/Min) at 0 radial offset

B20: 62 - 63

B20: 57 - 59

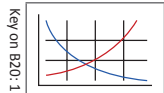

i = Imperial (in)  
m = Metric (mm)

Inserts sold separately

**IMPORTANT:** Max spindle speed refers to maximum possible speed for individual boring head and is not a recommended parameter. Refer to page B20: 62 for recommended application specific parameters. Factory technical assistance is available for your specific applications through our Application Engineering department.  
ext: 7611 | email: [appeng@alliedmachine.com](mailto:appeng@alliedmachine.com)

## Boring Inserts

### Coated 80° Diamond Inserts

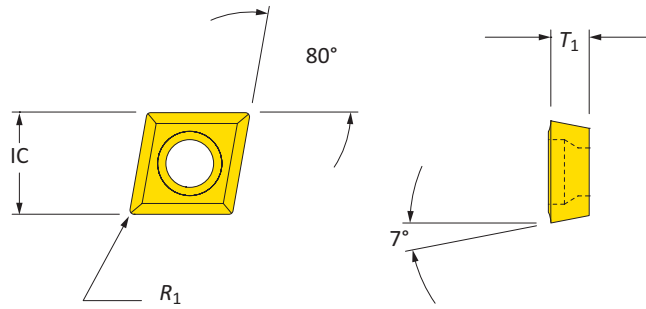

	Insert Form	Insert			Part No.
		IC	T <sub>1</sub>	R <sub>1</sub>	
<b>i</b>	CC..215..	0.250	0.094	0.008	CCMT060202
	CC..325..	0.375	0.156	0.008	CCMT09T302
	CC..325..	0.375	0.156	0.016	CCMT09T304
<b>m</b>	CC..0602..	6.35	2.38	0.20	CCMT060202
	CC..09T3..	9.53	3.97	0.20	CCMT09T302
	CC..09T3..	9.53	3.97	0.40	CCMT09T304

A  
DRILLING  
  
B  
BORING  
  
C  
REAMING  
  
D  
BURNISHING  
  
E  
THREADING  
  
X  
SPECIALS

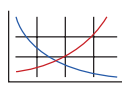
B20: 62 - 63  **Key on B20: 1**

B20: 57 - 59 

**i** = Imperial (in)  
**m** = Metric (mm)  
Inserts sold separately





# WE KNOW

TOLERANCE MATTERS

## Cri-Bore<sup>®</sup> Micro Adjusting

Allows for 0.00005" (0.001mm) on diameter bore increments

Modular system can be used on virtually any machine

Available in both imperial (in) and metric (mm) versions



### Cri-Bore® Micro Adjusting Finish Boring Heads

Bore Diameter Range: 1.050" - 5.065" (27.00mm - 128.00mm)

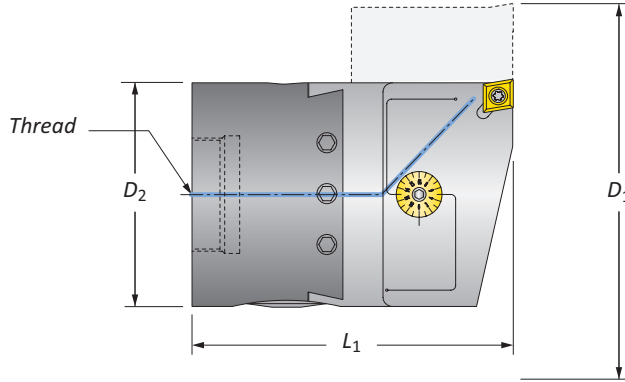

	Boring Range		Boring Head		Weight	Insert Form	Part. No
	$D_1$	Thread Connection	$L_1$	$D_2$			
i	1.050 - 1.320	¾ - 20	2.690	1.000	0.500 (lbs)	CC..215..	CB1000CC
	1.050 - 1.320	¾ - 20	2.690	1.000	0.500 (lbs)	TC..215..	CB1000TC
	1.300 - 1.600	¾ - 20	2.900	1.250	0.800 (lbs)	CC..215..	CB1250CC
	1.300 - 1.600	¾ - 20	2.900	1.250	0.800 (lbs)	TC..215..	CB1250TC
	1.585 - 2.700	¾ - 20	3.200	1.500	1.300 (lbs)	CC..325..	CB1500CC
	1.585 - 2.700	¾ - 20	3.200	1.500	1.300 (lbs)	TC..325..	CB1500TC
	2.060 - 3.320	¾ - 20	3.590	2.000	2.400 (lbs)	CC..325..	CB2000CC
	2.060 - 3.320	¾ - 20	3.590	2.000	2.400 (lbs)	TC..325..	CB2000TC
m	3.065 - 5.065	1½ - 18	4.100	3.000	5.800 (lbs)	CC..325..	CB3000CC
	3.065 - 5.065	1½ - 18	4.100	3.000	5.800 (lbs)	TC..325..	CB3000TC
	27.00 - 33.00	¾ - 20	68.35	25.00	0.23 (kg)	CC..0602..	CB025MCC
	27.00 - 33.00	¾ - 20	68.35	25.00	0.23 (kg)	TC..1102..	CB025MTC
	33.00 - 41.00	¾ - 20	73.65	32.00	0.36 (kg)	CC..0602..	CB032MCC
	33.00 - 41.00	¾ - 20	73.65	32.00	0.36 (kg)	TC..1102..	CB032MTC
	41.00 - 68.00	¾ - 20	81.25	38.00	0.59 (kg)	CC..09T3..	CB038MCC
	41.00 - 68.00	¾ - 20	81.25	38.00	0.59 (kg)	TC..16T3..	CB038MTC
	53.00 - 84.00	¾ - 20	91.30	50.00	1.09 (kg)	CC..09T3..	CB050MCC
	53.00 - 84.00	¾ - 20	91.30	50.00	1.09 (kg)	TC..16T3..	CB050MTC
78.00 - 128.00	1½ - 18	104.25	76.00	2.36 (kg)	CC..09T3..	CB076MCC	
78.00 - 128.00	1½ - 18	104.25	76.00	2.36 (kg)	TC..16T3..	CB076MTC	

Imperial (in) = 0.00005" adjustment on diameter

Metric (mm) = 0.001mm adjustment on diameter

**NOTE:** Max spindle speed: 1,000 SFM (305 M/Min) at 0 radial offset

B20: 62 - 63

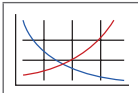

B20: 50 - 54

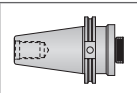

B20: 48 - 49

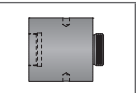

B20: 57 - 59



i = Imperial (in)

m = Metric (mm)

Inserts sold separately

**IMPORTANT:** Max spindle speed refers to maximum possible speed for individual boring head and is not a recommended parameter. Refer to page B20: 62 for recommended application specific parameters. Factory technical assistance is available for your specific applications through our Application Engineering department.

ext: 7611 | email: [appeng@alliedmachine.com](mailto:appeng@alliedmachine.com)

A DRILLING  
B BORING  
C REAMING  
D BURNISHING  
E THREADING  
X SPECIALS

## Boring Inserts

80° Diamond Insert | 60° Triangle Insert

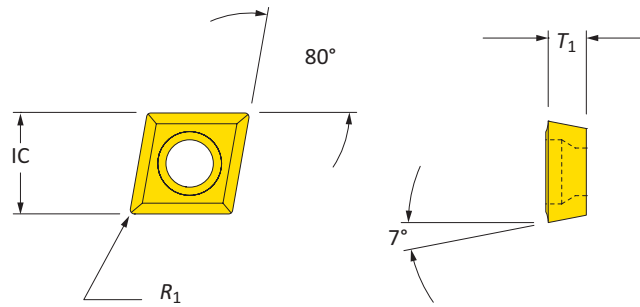

### Coated 80° Diamond Inserts

	Insert Form	Insert			Part No.
		IC	T <sub>1</sub>	R <sub>1</sub>	
<b>i</b>	CC..215..	0.250	0.094	0.008	CCMT060202
	CC..215..	0.250	0.094	0.016	CCMT060204
	CC..325..	0.375	0.156	0.008	CCMT09T302
	CC..325..	0.375	0.156	0.016	CCMT09T304
<b>m</b>	CC..0602..	6.35	2.38	0.20	CCMT060202
	CC..0602..	6.35	2.38	0.40	CCMT060204
	CC..09T3..	9.53	3.97	0.20	CCMT09T302
	CC..09T3..	9.53	3.97	0.40	CCMT09T304

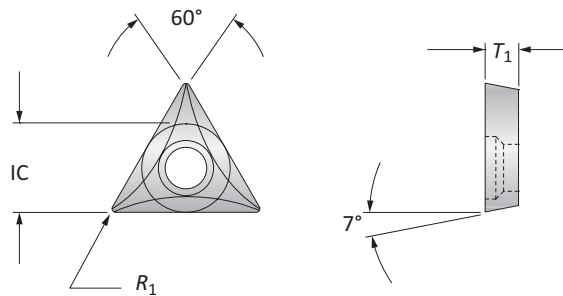

### Coated 60° Triangle Inserts

	Insert Form	Insert			Part No.
		IC	T <sub>1</sub>	R <sub>1</sub>	
<b>i</b>	TC..215..	0.250	0.094	0.008	TCGT110202
	TC..215..	0.250	0.094	0.016	TCGT110204
	TC..325..	0.375	0.156	0.016	TCGT16T304
<b>m</b>	TC..1102..	6.35	2.38	0.20	TCGT110202
	TC..1102..	6.35	2.38	0.40	TCGT110204
	TC..16T3..	9.53	3.97	0.40	TCGT16T304

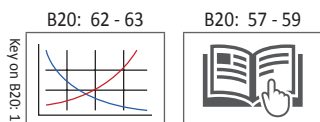

**i** = Imperial (in)  
**m** = Metric (mm)  
 Inserts sold separately

A DRILLING  
 B BORING  
 C REAMING  
 D BURNISHING  
 E THREADING  
 X SPECIALS







# EXTEND YOUR BORING RANGE

## Large Cri-Bore<sup>®</sup> Finish Boring / OD Turning System

Extend the diameter range for internal and external boring

Modular tooling system allows for CAT, BT, or HSK shanks

Allows for 0.00005" (0.001mm) on diameter bore increments

Large Cri-Bore® Finish Boring / OD Turning System



Cri-Bore Boring Head / Optional Component Combinations

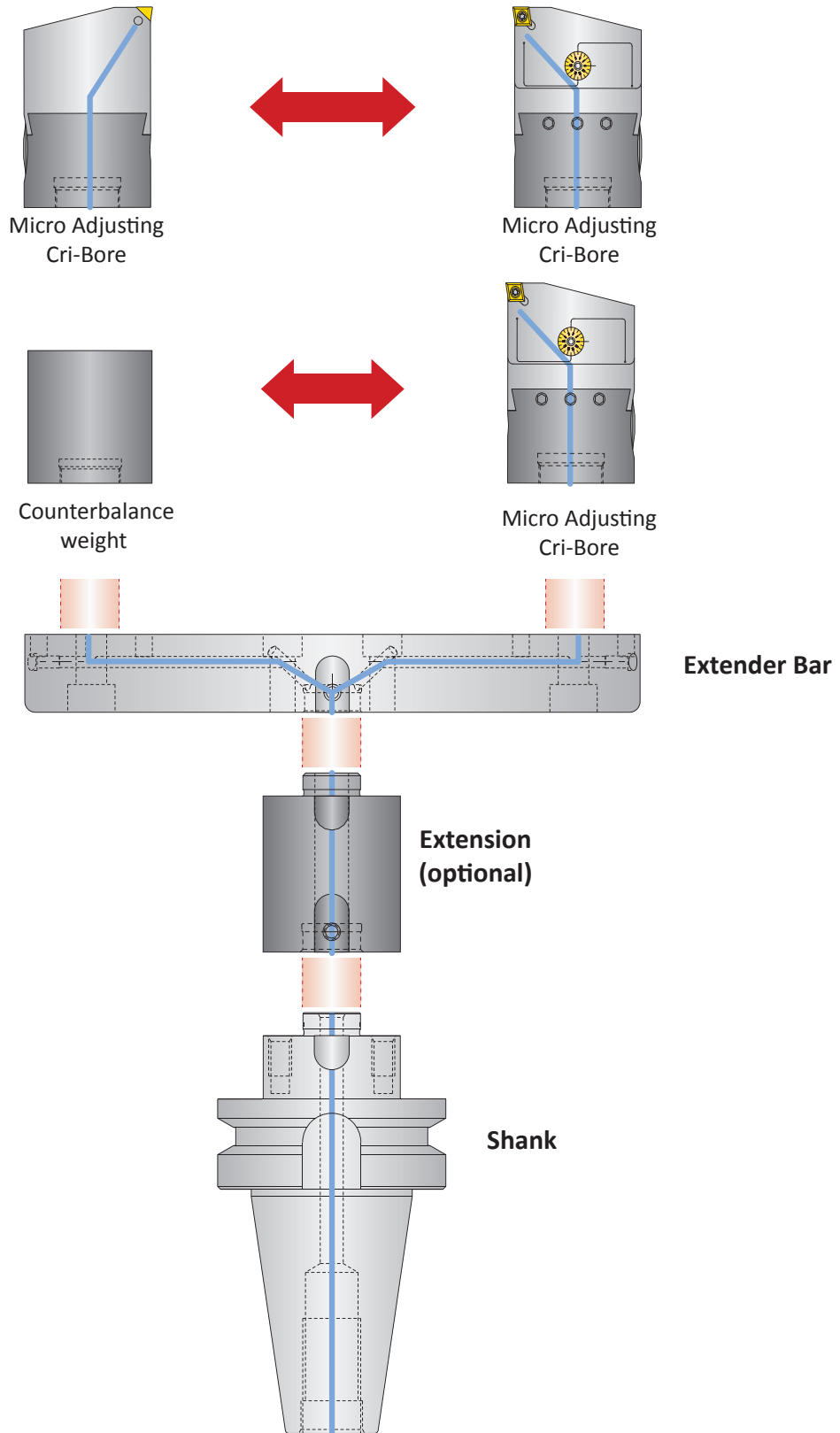

**⚠ WARNING** Exceeding weight capacity for machine tool spindle and tool changer can cause machine damage and/or serious injury. To prevent:

- Refer to page B20: 61 to see formula for calculating weight of tool assembly.
- Consult machine tool builder for machine's weight limitations.

Factory technical assistance is also available for specific applications through our Application Engineering department. ext: 7611 | email: [appeng@alliedmachine.com](mailto:appeng@alliedmachine.com)

A  
DRILLING  
B  
BORING  
C  
REAMING  
D  
BURNISHING  
E  
THREADING  
X  
SPECIALS

## Cri-Bore Micro Adjusting Finish Boring Heads | Counter Weights

Bore ID Range: 5.000" - 12.125" (127.00mm - 307.90mm) | Bore OD Range: 0.710" - 7.830" (18.10mm - 198.80mm)

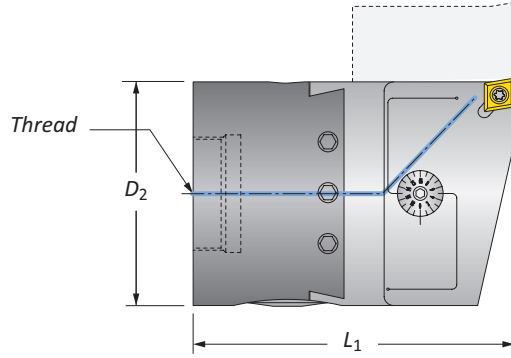

### Cri-Bore Micro Adjusting Boring Heads

	Connection Thread	Boring Head		Weight	Insert Form	Part No.
		$L_1$	$D_2$			
i	$\frac{7}{8}$ - 20	3.200	1.500	1.300 (lbs)	CC..325..	<b>CB1500CC</b>
	$\frac{7}{8}$ - 20	3.200	1.500	1.300 (lbs)	TC..325..	<b>CB1500TC</b>
m	$\frac{7}{8}$ - 20	81.25	38.00	0.59 (kg)	CC..09T3..	<b>CB038MCC</b>
	$\frac{7}{8}$ - 20	81.25	38.00	0.59 (kg)	TC..16T3..	<b>CB038MTC</b>

Imperial (in) = 0.00005" adjustment on diameter

Metric (mm) = 0.001mm adjustment on diameter

**NOTE:** Max spindle speed ID boring: 1,000 SFM (305 M/Min) at 0 radial offset and used with counter weight or additional boring head

**NOTE:** Max spindle speed OD boring: Contact our Application Engineering department

### Large Cri-Bore Counter Weights

	Counter Weight		Weight	Part No.
	$D_2$	$L_1$		
i	1.500	2.580	1.250 (lbs)	<b>LCB1500-CBWT A</b>
m	38.10	65.53	0.57 (kg)	<b>LCB1500-CBWT A</b>

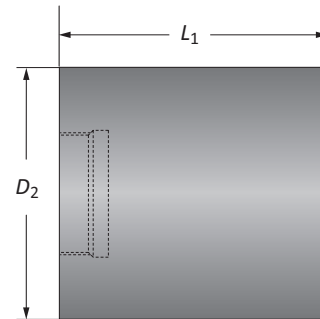

B20: 62 - 63

B20: 57 - 59

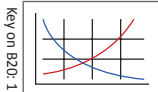

i = Imperial (in)  
m = Metric (mm)

Inserts sold separately

**IMPORTANT:** Max spindle speed refers to maximum possible speed for individual boring head and is not a recommended parameter. Refer to page B20: 62 for recommended application specific parameters. Factory technical assistance is available for your specific applications through our Application Engineering department.  
ext: 7611 | email: [appeng@alliedmachine.com](mailto:appeng@alliedmachine.com)

**WARNING** Exceeding weight capacity for machine tool spindle and tool changer can cause machine damage and/or serious injury. To prevent:

- Refer to page B20: 61 to see formula for calculating weight of tool assembly.
- Consult machine tool builder for machine's weight limitations.

Factory technical assistance is also available for specific applications through our Application Engineering department.

## Large Cri-Bore® Finish Boring / OD Turning System Extender Bars | Extensions

Bore ID Range: 5.000" - 12.125" (127.00mm - 307.90mm) | Bore OD Range: 0.710" - 7.830" (18.10mm - 198.80mm)

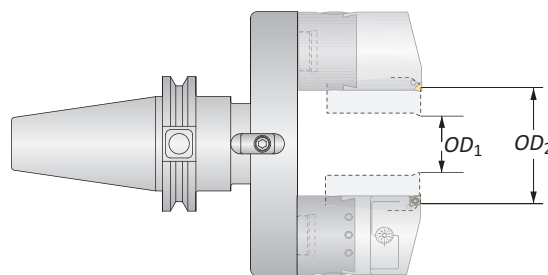
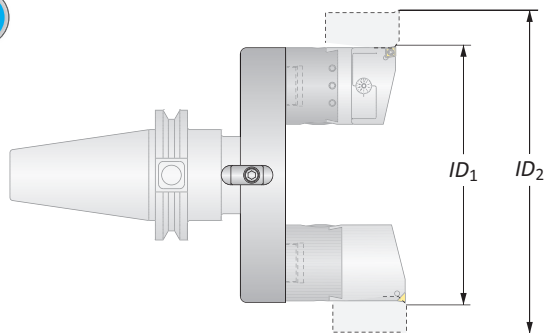

### Large Cri-Bore Extender Bars

Extender Bar						
	$ID_1$	$ID_2$	$OD_1$	$OD_2$	Weight	Part No.
i	5.000	6.125	0.710	1.830	1.560 (lbs)	LCB1500-56EBK
	6.000	7.125	1.710	2.830	1.920 (lbs)	LCB1500-67EBK
	7.000	8.125	2.710	3.830	2.290 (lbs)	LCB1500-78EBK
	8.000	9.125	3.710	4.830	2.650 (lbs)	LCB1500-89EBK
	9.000	10.125	4.710	5.830	3.010 (lbs)	LCB1500-910EBK
	10.000	11.125	5.710	6.830	3.370 (lbs)	LCB1500-1011EBK
	11.000	12.125	6.710	7.830	3.730 (lbs)	LCB1500-1112EBK
m	127.00	155.50	18.10	46.40	0.71 (kg)	LCB1500-56EBK
	152.40	180.90	43.50	71.80	0.87 (kg)	LCB1500-67EBK
	177.80	206.30	68.90	97.20	1.04 (kg)	LCB1500-78EBK
	203.20	231.70	94.30	122.60	1.20 (kg)	LCB1500-89EBK
	228.60	257.10	119.70	148.00	1.37 (kg)	LCB1500-910EBK
	254.00	282.50	145.10	173.40	1.53 (kg)	LCB1500-1011EBK
	279.40	307.90	170.50	198.80	1.69 (kg)	LCB1500-1112EBK



### Large Cri-Bore Extensions

Extension				
	$D_1$	$L_1$	Weight	Part No.
i	1.500	1.500	0.660 (lbs)	LCB1500-IA1500
	1.500	3.000	1.330 (lbs)	LCB1500-IA3000
	1.500	4.500	1.980 (lbs)	LCB1500-IA4500
m	38.10	38.10	0.30 (kg)	LCB1500-IA1500
	38.10	76.20	0.60 (kg)	LCB1500-IA3000
	38.10	114.30	0.90 (kg)	LCB1500-IA4500

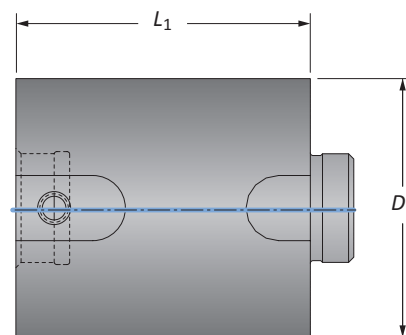

**NOTE:** Only one extension can be used per boring assembly. Extensions cannot be combined.

B20: 62 - 63

B20: 57 - 59

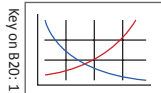

i = Imperial (in)  
m = Metric (mm)

Inserts sold separately

**WARNING** Exceeding weight capacity for machine tool spindle and tool changer can cause machine damage and/or serious injury. To prevent:

- Refer to page B20: 61 to see formula for calculating weight of tool assembly.
- Consult machine tool builder for machine's weight limitations.

Factory technical assistance is also available for specific applications through our Application Engineering department. ext: 7611 | email: [appeng@alliedmachine.com](mailto:appeng@alliedmachine.com)

## Large Cri-Bore® Finish Boring / OD Turning System Shanks

Bore ID Range: 5.000" - 12.125" (127.00mm - 307.90mm) | Bore OD Range: 0.710" - 7.830" (18.10mm - 198.80mm)

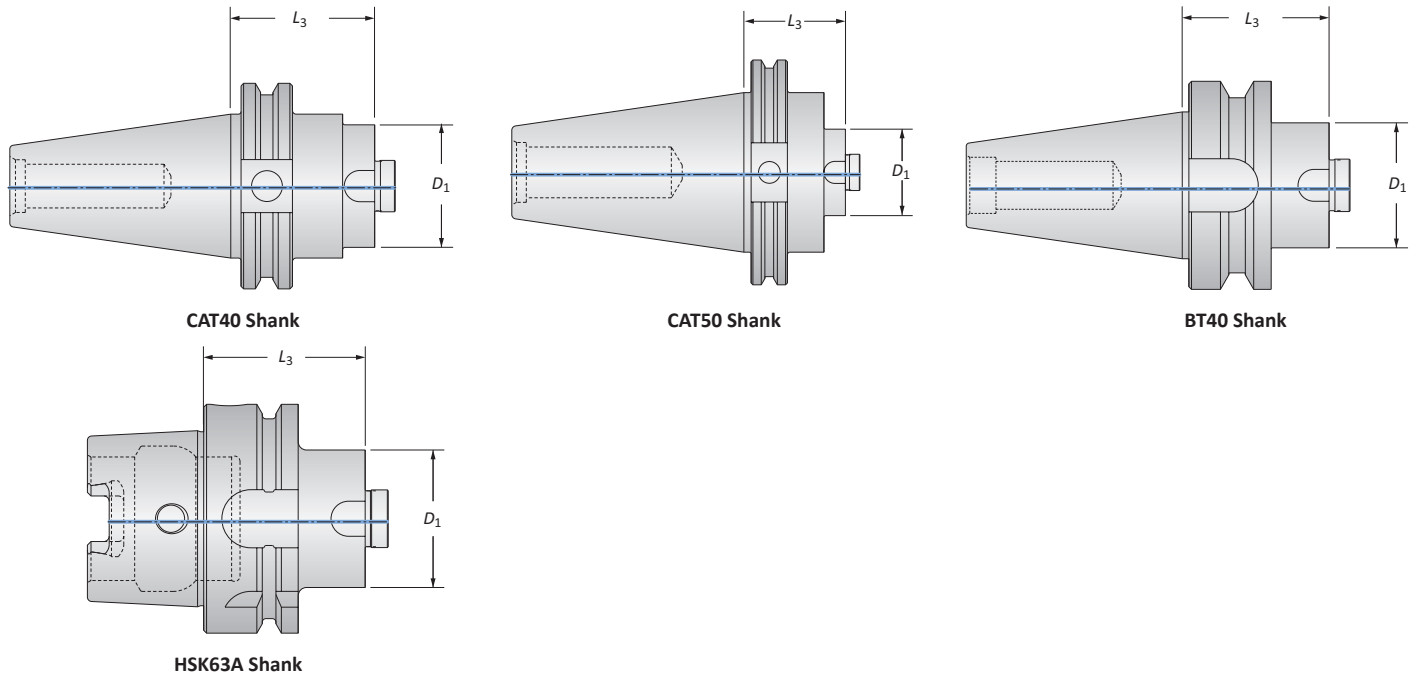

		Shank				
		$L_3$	$D_1$	Taper	Weight	Part No.
<b>i</b>		1.750	1.500	CAT40	2.410 (lbs)	<b>LCB1500-CV40</b>
		1.750	1.500	CAT50	6.960 (lbs)	<b>LCB1500-CV50</b>
		1.750	1.500	BT40	2.460 (lbs)	<b>LCB1500-BT40</b>
		1.750	1.500	HSK63A	1.750 (lbs)	<b>LCB1500-HSK63A</b>
		44.45	38.10	CAT40	1.09 (kg)	<b>LCB1500-CV40</b>
		44.45	38.10	CAT50	3.16 (kg)	<b>LCB1500-CV50</b>
		44.45	38.10	BT40	1.12 (kg)	<b>LCB1500-BT40</b>
		44.45	38.10	HSK63A	0.79 (kg)	<b>LCB1500-HSK63A</b>

B20: 62 - 63

B20: 57 - 59

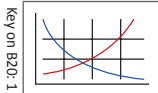

**i** = Imperial (in)  
**m** = Metric (mm)

Inserts sold separately

**WARNING** Exceeding weight capacity for machine tool spindle and tool changer can cause machine damage and/or serious injury. To prevent:

- Refer to page B20: 61 to see formula for calculating weight of tool assembly.
- Consult machine tool builder for machine's weight limitations.

Factory technical assistance is also available for specific applications through our Application Engineering department. ext: 7611 | email: [appeng@alliedmachine.com](mailto:appeng@alliedmachine.com)

## Boring Inserts

80° Diamond Insert | 60° Triangle Insert

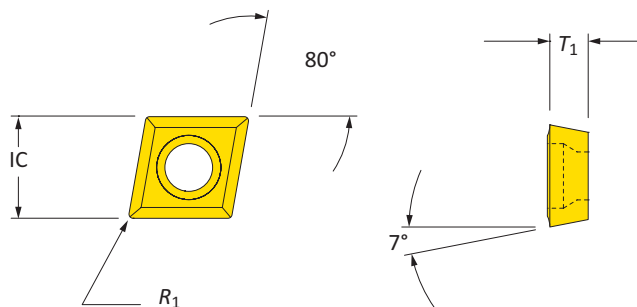

### Coated 80° Diamond Inserts

	Insert Form	Insert			Part No.
		IC	T <sub>1</sub>	R <sub>1</sub>	
<b>i</b>	CC..325..	0.375	0.156	0.008	CCMT09T302
	CC..325..	0.375	0.156	0.016	CCMT09T304
	CC..325..	0.375	0.156	0.031	CCMT09T308
<b>m</b>	CC..09T3..	9.53	3.97	0.20	CCMT09T302
	CC..09T3..	9.53	3.97	0.40	CCMT09T304
	CC..09T3..	9.53	3.97	0.80	CCMT09T308

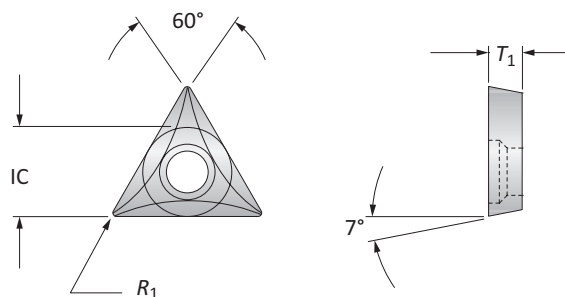

### Coated 60° Triangle Inserts

	Insert Form	Insert			Part No.
		IC	T <sub>1</sub>	R <sub>1</sub>	
<b>i</b>	TC..325..	0.375	0.156	0.016	TCGT16T304
<b>m</b>	TC..16T3..	9.53	3.97	0.40	TCGT16T304

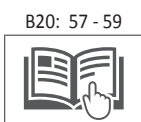
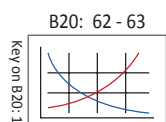

**i** = Imperial (in)  
**m** = Metric (mm)  
 Inserts sold separately



# NEED VERSATILITY? NO PROBLEM.

## CB Style Versatile Boring

Wide range of diameters produced with  
a single boring head

Allows for 0.001" adjustment on bore diameter and  
0.000050" with CB2500BMA

Maximum toughness and maximum versatility



## CB2500BMA Micro Adjusting Versatile Boring Head

Bore Diameter Range: 0.250" - 3.125"

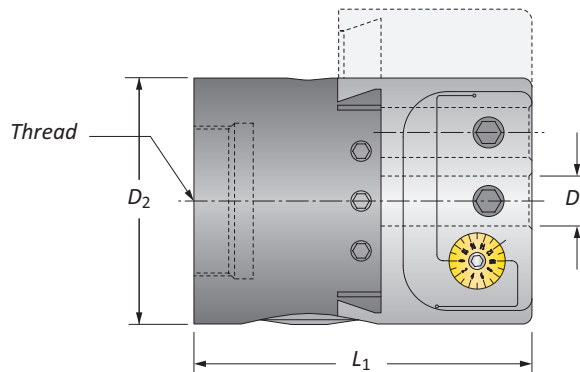

		Boring Head			Weight	Part No.
Boring Range	Thread Connection	$L_1$	$D_2$	$D_3$		
<b>i</b> 0.250 - 3.125	1½ - 18	3.375	2.500	0.500	3.400 (lbs)	<b>CB2500BMA</b>

Imperial (in) = 0.00005" adjustment on diameter

**NOTE:** Max spindle speed: 2,000 RPM at 0 radial offset

A

DRILLING

B

BORING

C

REAMING

D

BURNISHING

E

THREADING

X

SPECIALS

key on B20: 1

B20: 62 - 63

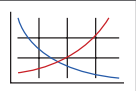

B20: 50 - 54

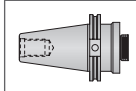

B20: 48 - 49

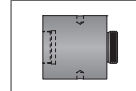

B20: 57 - 58



**i** = Imperial (in)  
**m** = Metric (mm)

Inserts sold separately

**IMPORTANT:** Max spindle speed refers to maximum possible speed for individual boring head and is not a recommended parameter. Refer to page B20: 62 for recommended application specific parameters. Factory technical assistance is available for your specific applications through our Application Engineering department.  
ext: 7611 | email: [appeng@alliedmachine.com](mailto:appeng@alliedmachine.com)

## Boring Bars

Bore Diameter Range: 0.250" - 3.125"

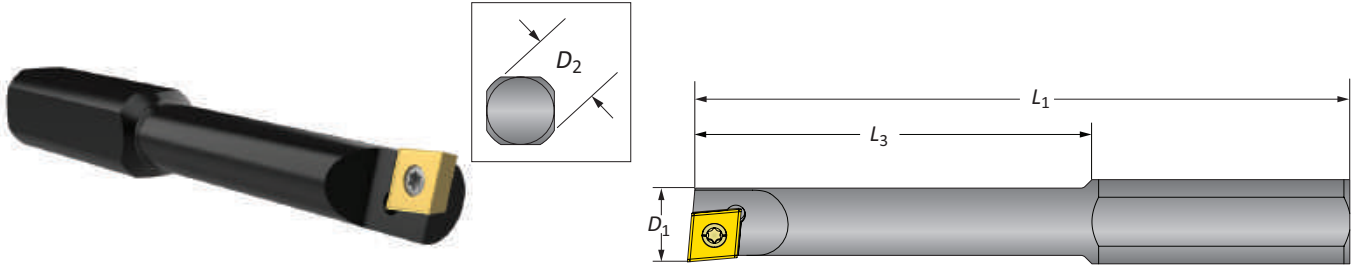

### Steel Boring Bars | Bore Diameter Range: 0.250" - 3.125"

Min. Boring Diameter	Boring Bar				Weight	Insert Form	Part No.
	$D_1$	$L_3$	$L_1$	$D_2$			
0.250	1.062	2.500	0.500	0.080 (lbs)	WBGX0301..	<b>0250B</b>	
0.312	1.437	2.750	0.500	0.080 (lbs)	WBGX0301..	<b>0312B</b>	
<b>i</b> 0.375	1.750	3.062	0.500	0.100 (lbs)	WBGX0301..	<b>0375B</b>	
0.437	2.062	3.375	0.500	0.110 (lbs)	CC..215..	<b>0437B</b>	
0.500	2.187	3.500	0.500	0.140 (lbs)	CC..215..	<b>0500B</b>	

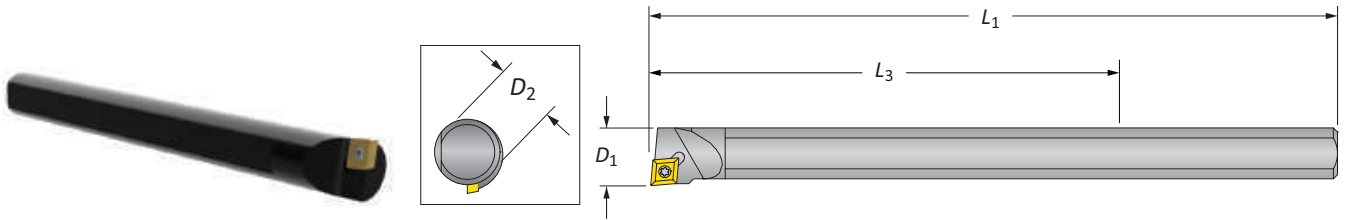

### Heavy Metal Boring Bars | Bore Diameter Range: 0.365" - 3.125"

Min. Boring Diameter	Boring Bar				Weight	Insert Form	Part No.
	$D_1$	$L_3$	$L_1$	$D_2$			
<b>i</b> 0.365	2.250	4.000	0.312*	0.080 (lbs)	CC..215..	<b>0365HM</b>	
0.550	3.250	6.000	0.500	0.300 (lbs)	CC..215..	<b>0550BHM</b>	

\*Reducing sleeve required

### Reducing Sleeves

Reducing Sleeve					Weight	Part No.
	$D_3$	$D_2$	$L_1$	$L_3$		
<b>i</b> 0.312	0.500	1.312	-	0.040 (lbs)	<b>BTH-03120500</b>	
0.375	0.500	1.312	-	0.030 (lbs)	<b>BTH-03750500</b>	

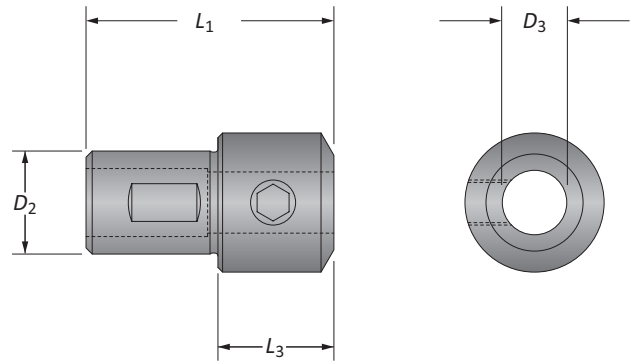

B20: 62 - 63

B20: 57 - 59

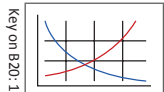

**i** = Imperial (in)  
**m** = Metric (mm)

## Boring Bar | Boring Inserts

Bore Diameter Range: 0.625" - 3.125"

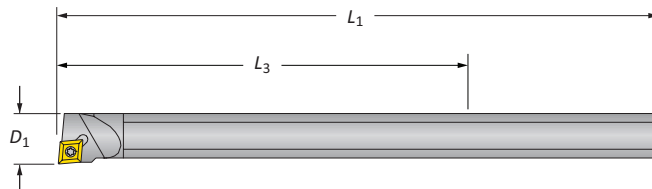
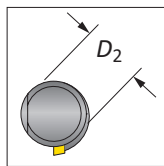

### Carbide Boring Bar

	Min. Boring Diameter	Boring Bar			Weight	Insert Form	Part No.
	$D_1$	$L_3$	$L_1$	$D_2$			
<b>i</b>	0.625	4.500	8.000	0.500	0.410 (lbs)	CC..215..	<b>0625BCS</b>

### Coated Trigon Insert

	Insert Form	Insert	Part No.
		$R_1$	
<b>i</b>	WBGX0301..	0.004	<b>WBGX030101</b>

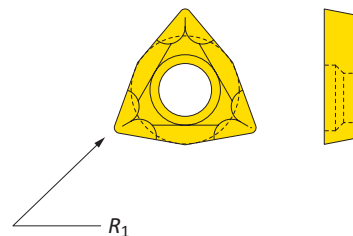

### Coated 80° Diamond Inserts

	Insert Form	Insert			Part No.
		IC	$T_1$	$R_1$	
<b>i</b>	CC..215..	0.250	0.094	0.008	<b>CCMT060202</b>
	CC..215..	0.250	0.094	0.016	<b>CCMT060204</b>
	CC..215..	0.250	0.094	0.031	<b>CCMT060208</b>

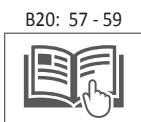
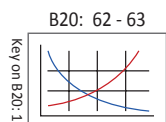
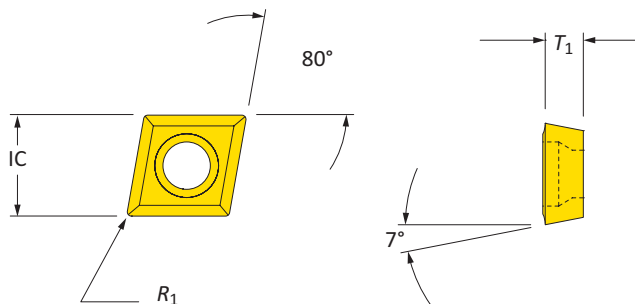

Key on B20-1

**i** = Imperial (in)  
**m** = Metric (mm)  
 Inserts sold separately

A DRILLING  
 B BORING  
 C REAMING  
 D BURNISHING  
 E THREADING  
 X SPECIALS

## CB202B Versatile Boring Head

Bore Diameter Range: 0.250" - 6.687"

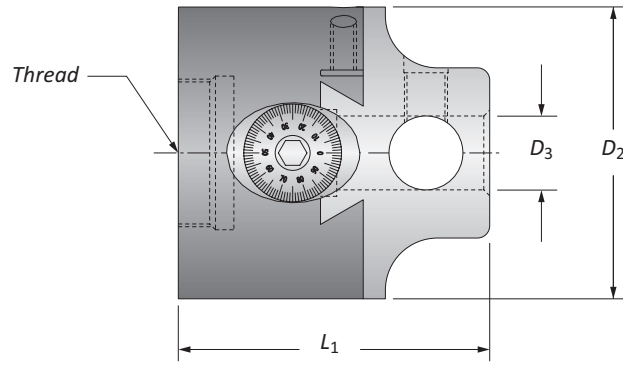

	Boring Range	Thread Connection	Boring Head			Weight	Part No.
			$L_1$	$D_2$	$D_3$		
<b>i</b>	0.250 - 6.687	$\frac{7}{8}$ - 20	2.435	2.000	0.500	1.600 (lbs)	<b>CB202B</b>

**NOTICE:** Cross hole bars should always be secured in the bar holder with at least two set screws

Imperial (in) = 0.001" adjustment on diameter

**NOTE:** Max spindle speed: 2,500 RPM at 0 radial offset

A DRILLING  
B BORING  
C REAMING  
D BURNISHING  
E THREADING  
X SPECIALS

Key on B20: 1

B20: 62 - 63

B20: 50 - 54

B20: 48 - 49

B20: 57 - 59

**i** = Imperial (in)  
**m** = Metric (mm)

**IMPORTANT:** Max spindle speed refers to maximum possible speed for individual boring head and is not a recommended parameter. Refer to page B20: 62 for recommended application specific parameters. Factory technical assistance is available for your specific applications through our Application Engineering department.  
ext: 7611 | email: [appeng@alliedmachine.com](mailto:appeng@alliedmachine.com)

## Boring Bars

Bore Diameter Range: 0.250" - 3.000"

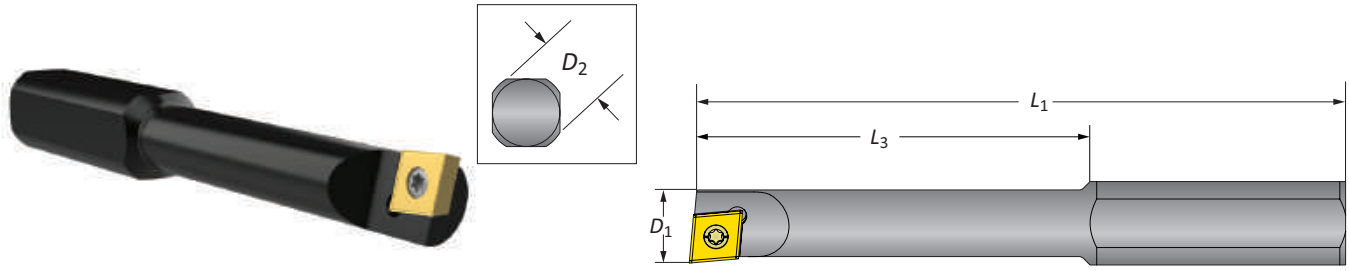

### Steel Boring Bars | Bore Diameter Range: 0.250" - 3.000"

Min. Boring Diameter	Boring Bar				Weight	Insert Form	Part No.
	$D_1$	$L_3$	$L_1$	$D_2$			
<b>i</b> 0.250	1.062	2.500	0.500	0.080 (lbs)	WBGX0301..	<b>0250B</b>	
0.312	1.437	2.750	0.500	0.080 (lbs)	WBGX0301..	<b>0312B</b>	
0.375	1.750	3.062	0.500	0.100 (lbs)	WBGX0301..	<b>0375B</b>	
0.437	2.062	3.375	0.500	0.110 (lbs)	CC..215..	<b>0437B</b>	
0.500	2.187	3.500	0.500	0.140 (lbs)	CC..215..	<b>0500B</b>	

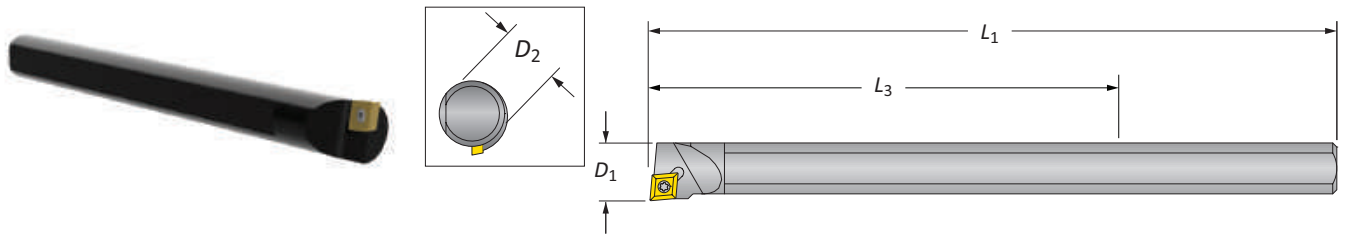

### Heavy Metal Boring Bars | Bore Diameter Range: 0.365" - 3.000"

Min. Boring Diameter	Boring Bar				Weight	Insert Form	Part No.
	$D_1$	$L_3$	$L_1$	$D_2$			
<b>i</b> 0.365	2.250	4.000	0.312*	0.080 (lbs)	CC..215..	<b>0365HM</b>	
0.550	3.250	6.000	0.500	0.300 (lbs)	CC..215..	<b>0550BHM</b>	

\*Reducing sleeve required

### Carbide Boring Bar | Bore Diameter Range: 0.625" - 3.000"

Min. Boring Diameter	Boring Bar				Weight	Insert Form	Part No.
	$D_1$	$L_3$	$L_1$	$D_2$			
<b>i</b> 0.625	4.500	8.000	0.500	0.410 (lbs)	CC..215..	<b>0625BCS</b>	

### Reducing Sleeves

Reducing Sleeve					Weight	Part No.
	$D_3$	$D_2$	$L_1$	$L_3$		
<b>i</b> 0.312	0.500	1.312	-	0.040 (lbs)	<b>BTH-03120500</b>	
0.375	0.500	1.312	-	0.030 (lbs)	<b>BTH-03750500</b>	

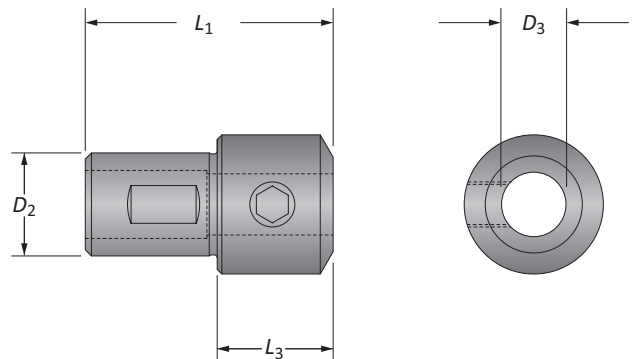

B20: 62 - 63

B20: 57 - 59

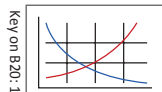

**i** = Imperial (in)  
**m** = Metric (mm)

## Boring Bar

Bore Diameter Range: 2.875" - 6.687"

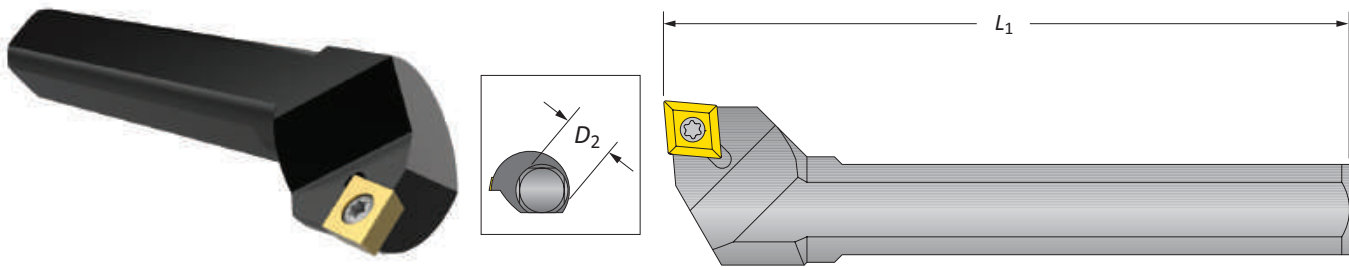

	Boring Bar*		Weight	Insert Form	Part No.
	Min. Boring Diameter	$L_1$			
<b>i</b>	2.875	2.750	0.140 (lbs)	CC..215..	0500BCH

\*NOTICE: Cross hole bars should always be secured in the bar holder with at least two set screws

A  
DRILLING  
B  
BORING  
C  
REAMING  
D  
BURNISHING  
E  
THREADING  
X  
SPECIALS

B20: 62 - 63

B20: 57 - 59

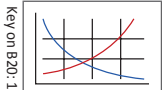

**i** = Imperial (in)  
**m** = Metric (mm)  
Inserts sold separately

## Boring Inserts

80° Diamond Insert | 60° Triangle Insert

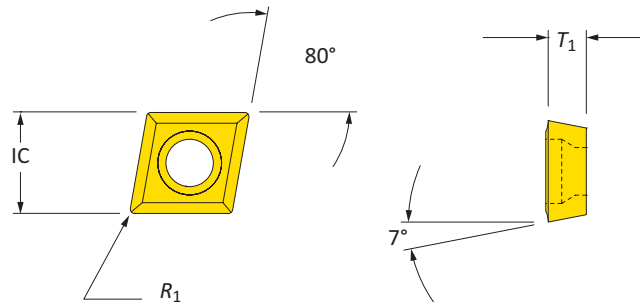

### Coated 80° Diamond Inserts

	Insert Form	Insert			Part No.
		IC	T <sub>1</sub>	R <sub>1</sub>	
i	CC..215..	0.250	0.094	0.008	CCMT060202
	CC..215..	0.250	0.094	0.016	CCMT060204
	CC..215..	0.250	0.094	0.031	CCMT060208

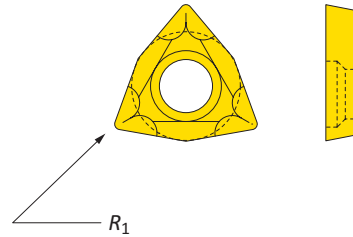

### Coated Trigon Insert

	Insert Form	Insert		Part No.
		R <sub>1</sub>		
i	WBGX0301..	0.004		WBGX030101

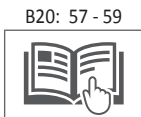
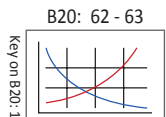

i = Imperial (in)  
m = Metric (mm)  
Inserts sold separately

A  
DRILLING  
B  
BORING  
C  
REAMING  
D  
BURNISHING  
E  
THREADING  
X  
SPECIALS

## CB203D Versatile Boring Head

Bore Diameter Range: 0.250" - 11.000"

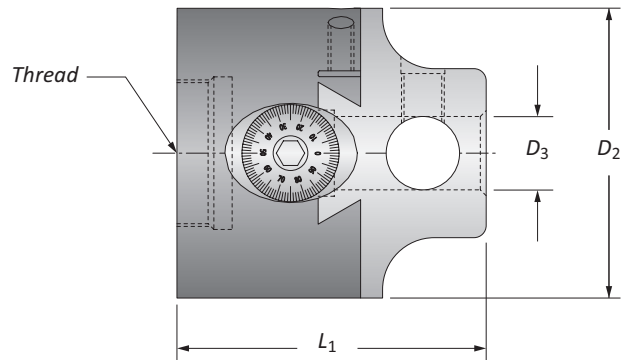

	Boring Range	Connection	Boring Head			Weight	Part No.
			$L_1$	$D_2$	$D_3$		
<b>i</b>	0.250 - 11.000	1½ - 18	5.165	3.000	0.750	4.700 (lbs)	<b>CB203D</b>

**NOTICE:** Cross hole bars should always be secured in the bar holder with at least two set screws

Imperial (in) = 0.001" adjustment on diameter

**NOTE:** Max spindle speed: 1,750 RPM at 0 radial offset

A DRILLING  
B BORING  
C REAMING  
D BURNISHING  
E THREADING  
X SPECIALS

B20: 62 - 63

Key on B20: 1

B20: 50 - 54

B20: 48 - 49

B20: 57 - 59

**i** = Imperial (in)  
**m** = Metric (mm)

Inserts sold separately

**IMPORTANT:** Max spindle speed refers to maximum possible speed for individual boring head and is not a recommended parameter. Refer to page B20: 62 for recommended application specific parameters. Factory technical assistance is available for your specific applications through our Application Engineering department.  
ext: 7611 | email: [appeng@alliedmachine.com](mailto:appeng@alliedmachine.com)

**WARNING** Exceeding weight capacity for machine tool spindle and tool changer can cause machine damage and/or serious injury. To prevent:

- Refer to page B20: 61 to see formula for calculating weight of tool assembly.
- Consult machine tool builder for machine's weight limitations.

Factory technical assistance is also available for specific applications through our Application Engineering department.



## Boring Bars

Bore Diameter Range: 0.250" - 5.125"

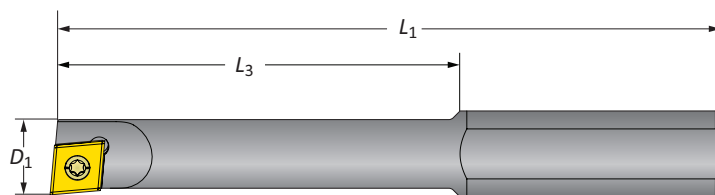

### Steel Boring Bars | Bore Diameter Range: 0.250" - 5.125"

Min. Boring Diameter	Boring Bar				Weight	Insert Form	Part No.
	$D_1$	$L_3$	$L_1$	$D_2$			
i	0.250	1.062	2.500	0.500*	0.080 (lbs)	WBGX0301..	<b>0250B</b>
	0.312	1.437	2.570	0.500*	0.080 (lbs)	WBGX0301..	<b>0312B</b>
	0.375	1.750	3.062	0.500*	0.100 (lbs)	WBGX0301..	<b>0375B</b>
	0.437	2.062	3.375	0.500*	0.110 (lbs)	CC..215..	<b>0437B</b>
	0.500	2.500	4.250	0.750	0.280 (lbs)	CC..215..	<b>0500D</b>
	0.750	3.000	4.687	0.750	0.430 (lbs)	CC..325..	<b>0750D</b>
	1.000	3.500	5.125	0.750	0.570 (lbs)	CC..325..	<b>1000D</b>
	1.250	4.000	5.562	0.750	0.570 (lbs)	CC..325..	<b>1250D</b>

\*Reducing sleeve required

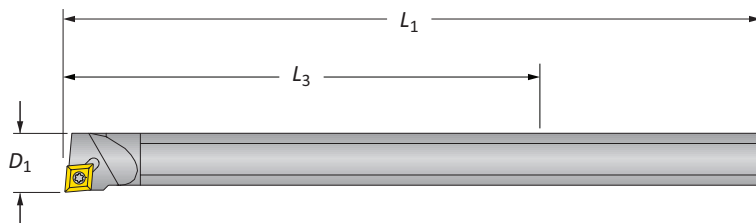

### Heavy Metal Boring Bars | Bore Diameter Range: 0.425" - 4.250"

Min. Boring Diameter	Boring Bar				Weight	Insert Form	Part No.
	$D_1$	$L_3$	$L_1$	$D_2$			
i	0.425	2.250	4.000	0.375*	0.110 (lbs)	CC..215..	<b>0425BHM</b>
	0.550	3.250	6.000	0.500*	0.300 (lbs)	CC..215..	<b>0550BHM</b>
	0.688	4.250	8.000	0.625*	0.630 (lbs)	CC..325..	<b>0688CHM</b>
	0.832	4.750	10.000	0.750	1.150 (lbs)	CC..325..	<b>0832DHM</b>

\*Reducing sleeve required

### Reducing Sleeves

Reducing Sleeve					Weight	Part No.
	$D_3$	$D_2$	$L_1$	$L_3$		
i	0.375	0.750	2.406	-	0.190 (lbs)	<b>BTH-03750750</b>
	0.500	0.750	2.406	0.910	0.040 (lbs)	<b>BTH-05000750</b>
	0.625	0.750	1.500	-	0.060 (lbs)	<b>BTH-06250750</b>

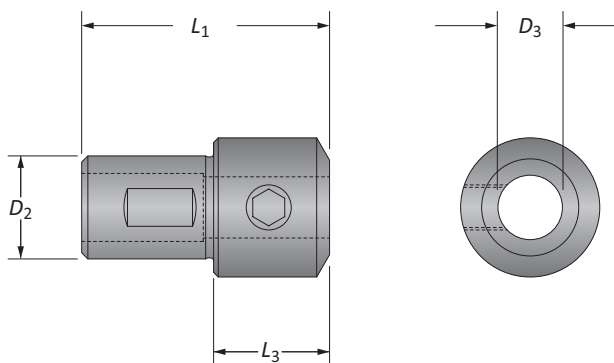

B20: 62 - 63

B20: 57 - 59

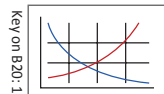

i = Imperial (in)  
m = Metric (mm)  
Inserts sold separately

## Carbide Boring Bars

Bore Diameter Range: 0.625" - 4.250"

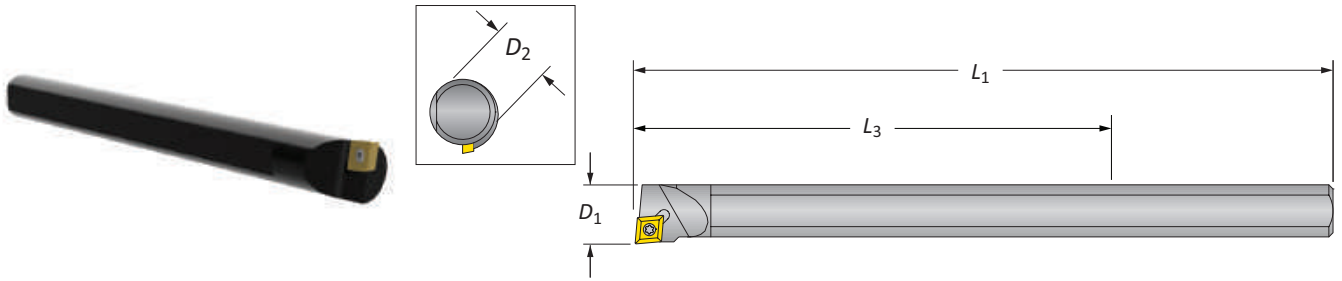

### Carbide Boring Bars

	Min. Boring Diameter	Boring Bar			Weight	Insert Form	Part No.
	$D_1$	$L_3$	$L_1$	$D_2$			
<b>i</b>	0.625	4.500	8.000	0.500*	0.410 (lbs)	CC..215..	<b>0625BCS</b>
	0.875	6.000	10.000	0.750	1.130 (lbs)	CC..325..	<b>0875DCS</b>

\*Reducing sleeve required

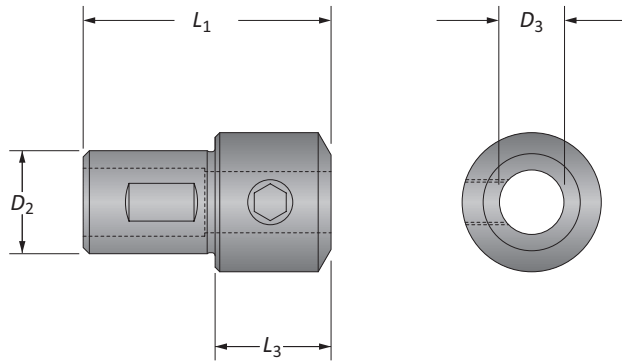

### Reducing Sleeve

	Reducing Sleeve				Weight	Part No.
	$D_3$	$D_2$	$L_1$	$L_3$		
<b>i</b>	0.500	0.750	2.406	0.910	0.040 (lbs)	<b>BTH-05000750</b>

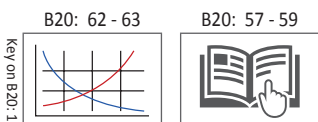

**i** = Imperial (in)  
**m** = Metric (mm)  
 Inserts sold separately

## Cross Hole Boring Bar | Boring Inserts

Bore Diameter Range: 4.937" - 11.000"

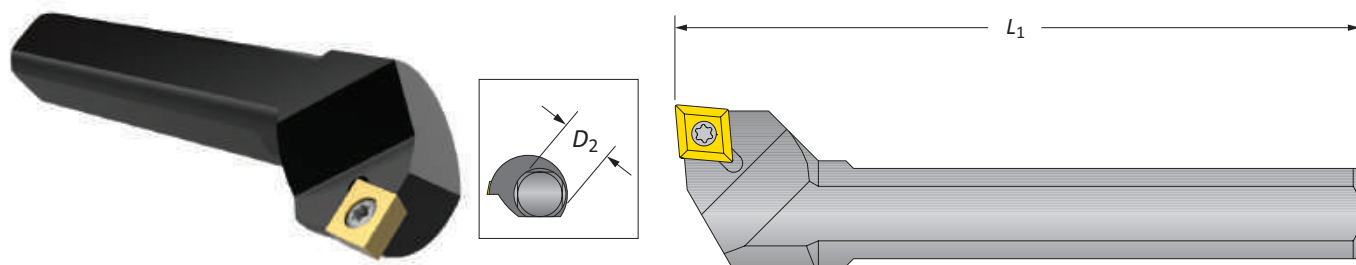

### Cross Hole Boring Bar

Min. Bore Diameter	Boring Bar*		Weight	Insert Form	Part No.
	$L_1$	$D_2$			
<b>i</b> 4.937	4.750	0.750	0.550 (lbs)	CC..325..	<b>0750DCH</b>

\*NOTICE: Cross hole bars should always be secured in the bar holder with at least two set screws

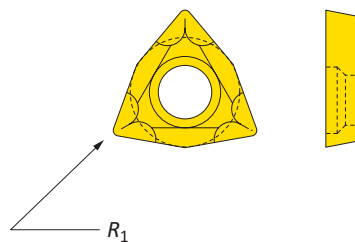

### Coated Trigon Insert

Insert Form	Insert $R_1$	Part No.
<b>i</b> WBGX0301...	0.004	<b>WBGX030101</b>

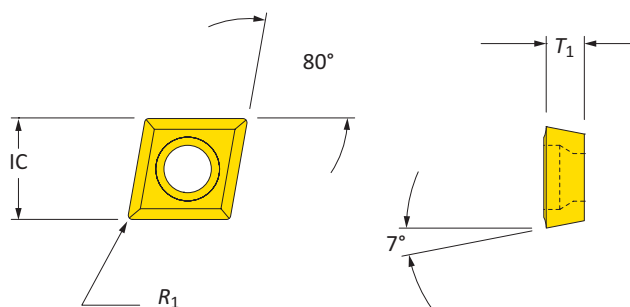

### Coated 80° Diamond Inserts

Insert Form	Insert			Part No.
	$IC$	$T_1$	$R_1$	
<b>i</b> CC..215..	0.250	0.094	0.008	<b>CCMT060202</b>
CC..215..	0.250	0.094	0.016	<b>CCMT060204</b>
CC..215..	0.250	0.094	0.031	<b>CCMT060208</b>
CC..325...	0.375	0.156	0.008	<b>CCMT09T302</b>
CC..325..	0.375	0.156	0.016	<b>CCMT09T304</b>
CC..325..	0.375	0.156	0.031	<b>CCMT09T308</b>

B20: 62 - 63

B20: 57 - 59

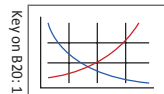

**i** = Imperial (in)  
**m** = Metric (mm)  
 Inserts sold separately

A DRILLING  
 B BORING  
 C REAMING  
 D BURNISHING  
 E THREADING  
 X SPECIALS

## CB204E Versatile Boring Head

Bore Diameter Range: 0.500" - 13.437"

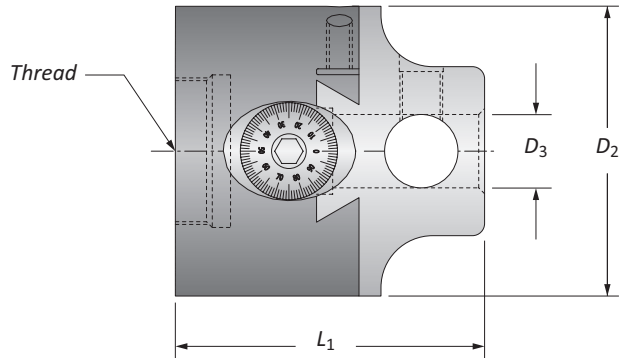

	Boring Range	Connection	Boring Head			Weight	Part No.
			$L_1$	$D_2$	$D_3$		
<b>i</b>	0.500 - 13.437	1½ - 18	3.715	4.000	1.000	9,300 (lbs)	CB204E

**NOTICE:** Cross hole bars should always be secured in the bar holder with at least two set screws

Imperial (in) = 0.001" adjustment on diameter

**NOTE:** Max spindle speed: 800 RPM at 0 radial offset

A DRILLING  
B BORING  
C REAMING  
D BURNISHING  
E THREADING  
X SPECIALS

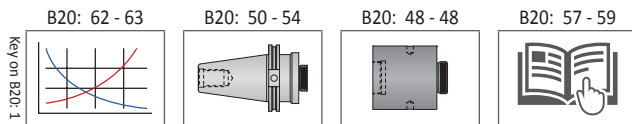

**i** = Imperial (in)  
**m** = Metric (mm)

**IMPORTANT:** Max spindle speed refers to maximum possible speed for individual boring head and is not a recommended parameter. Refer to page B20: 62 for recommended application specific parameters. Factory technical assistance is available for your specific applications through our Application Engineering department.  
ext: 7611 | email: [appeng@alliedmachine.com](mailto:appeng@alliedmachine.com)

**WARNING** Exceeding weight capacity for machine tool spindle and tool changer can cause machine damage and/or serious injury. To prevent:  
- Refer to page B20: 61 to see formula for calculating weight of tool assembly.  
- Consult machine tool builder for machine's weight limitations.  
Factory technical assistance is also available for specific applications through our Application Engineering department.

## Boring Bars

Bore Diameter Range: 0.500" - 5.750"

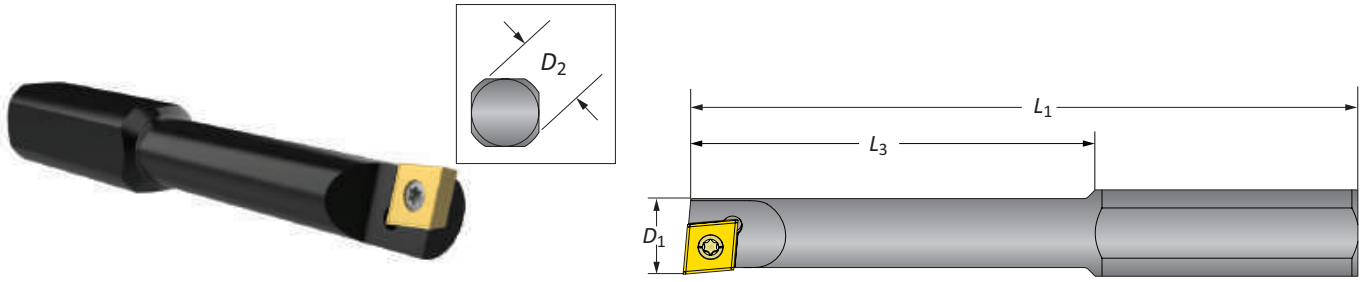

Steel Boring Bars | Bore Diameter Range: 0.500" - 5.750"

Min. Boring Diameter	Boring Bar				Weight	Insert Form	Part No.
	$D_1$	$L_3$	$L_1$	$D_2$			
<b>i</b> 0.500	2.500	4.250	0.750*	0.280 (lbs)	CC..215..	<b>0500D</b>	
0.750	3.000	4.687	0.750*	0.430 (lbs)	CC..325..	<b>0750D</b>	
1.000	3.500	5.125	0.750*	0.510 (lbs)	CC..325..	<b>1000D</b>	
1.250	4.000	5.562	0.750*	0.570 (lbs)	CC..325..	<b>1250D</b>	

\*Reducing sleeve required

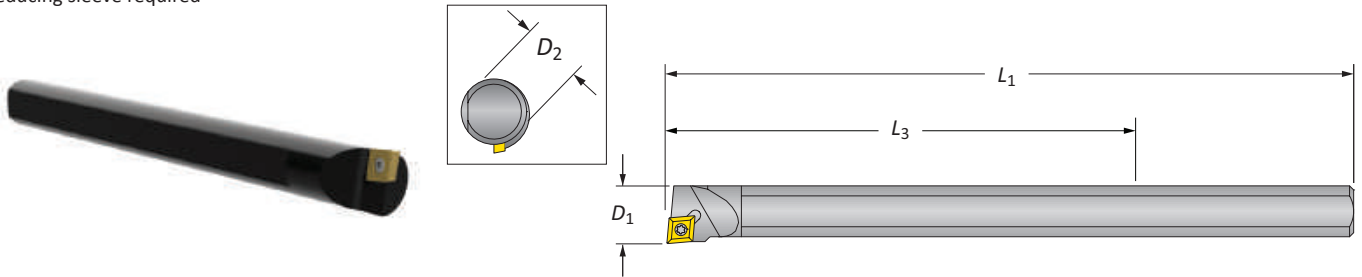

Heavy Metal Boring Bar | Bore Diameter Range: 0.832" - 5.125"

Min. Boring Diameter	Boring Bar				Weight	Insert Form	Part No.
	$D_1$	$L_3$	$L_1$	$D_2$			
<b>i</b> 0.832	4.750	10.000	0.750*	1.150 (lbs)	CC..325..	<b>0832DHM</b>	

\*Reducing sleeve required

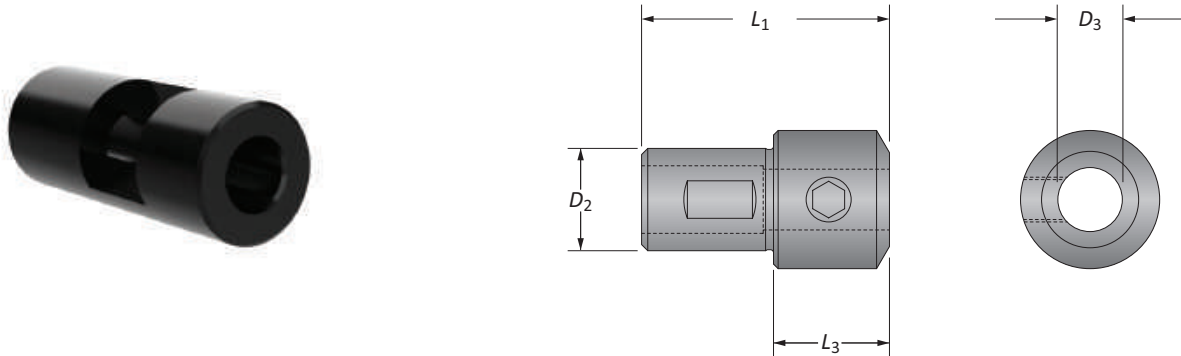

Reducing Sleeve

Min. Boring Diameter	Reducing Sleeve				Weight	Part No.
	$D_3$	$D_2$	$L_1$	$L_3$		
<b>i</b> 0.750	1.000	2.405	1.125	0.400 (lbs)	<b>BTH-07501000</b>	

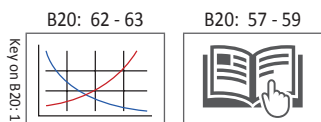

**i** = Imperial (in)  
**m** = Metric (mm)  
 Inserts sold separately

## Boring Bars

Bore Diameter Range: 0.875" - 5.125"

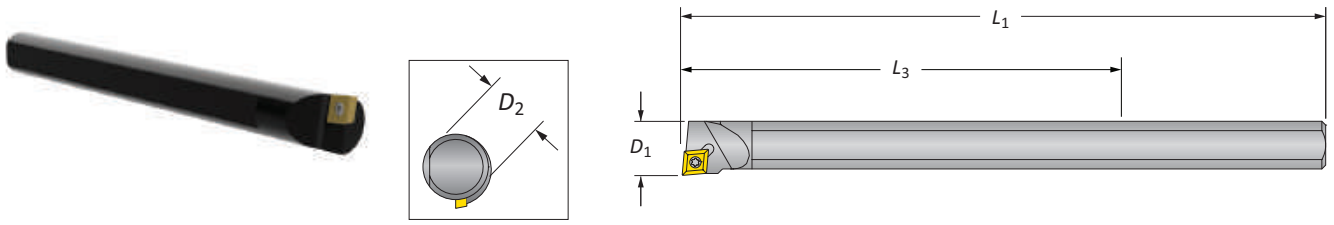

### Carbide Boring Bar

Min. Boring Diameter	Boring Bar				Weight	Insert Form	Part No.
	$D_1$	$L_3$	$L_1$	$D_2$			
<b>i</b> 0.875	6.000	10.000	0.750*	1.130 (lbs)	CC..325..	<b>0875DCS</b>	

\*Reducing sleeve required

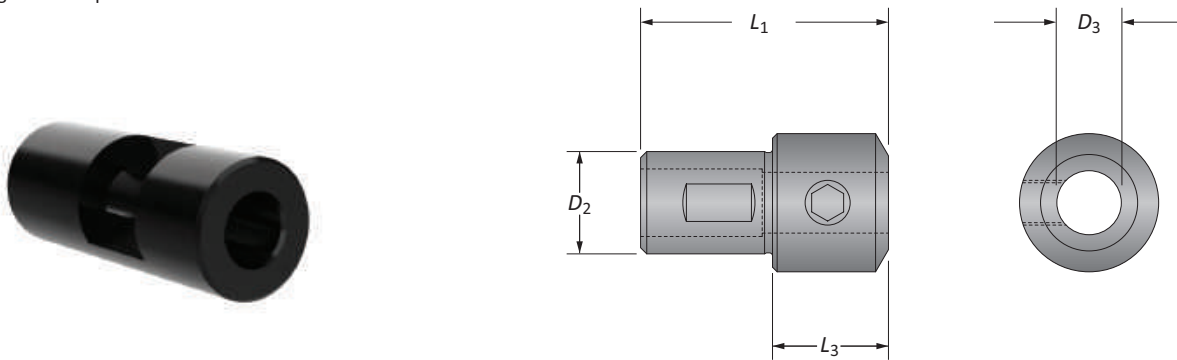

### Reducing Sleeve

Min. Boring Diameter	Reducing Sleeve				Weight	Part No.
	$D_3$	$D_2$	$L_1$	$L_3$		
<b>i</b> 0.750	1.000	2.405	1.125	0.400 (lbs)	<b>BTH-07501000</b>	

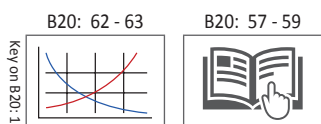

**i** = Imperial (in)  
**m** = Metric (mm)  
 Inserts sold separately

A DRILLING  
 B BORING  
 C REAMING  
 D BURNISHING  
 E THREADING  
 X SPECIALS

## Cross Hole Boring Bar | Boring Inserts

Bore Diameter Range: 5.625" - 13.437"

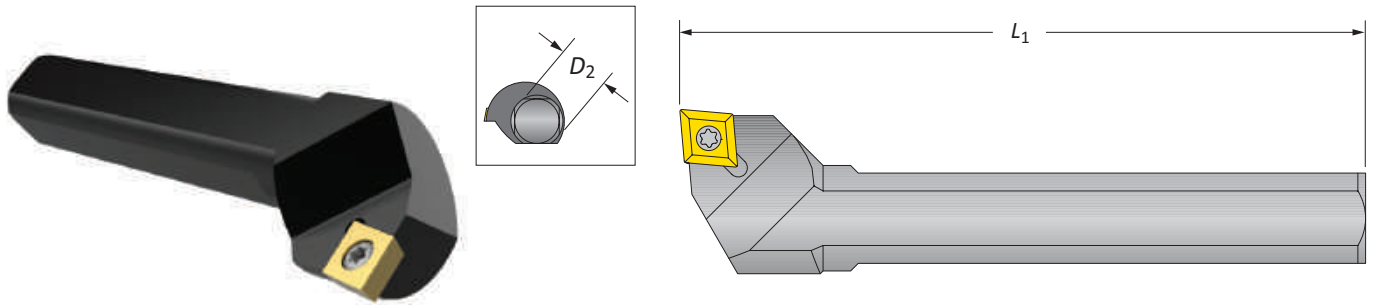

### Cross Hole Boring Bar

Min Boring Diameter	Boring Bar*		Weight	Insert Form	Part No.
	$L_1$	$D_2$			
<b>i</b> 5.625	5.310	1.000	1.020 (lbs)	CC..325..	1000ECH

\*NOTICE: Cross hole bars should always be secured in the bar holder with at least two set screws

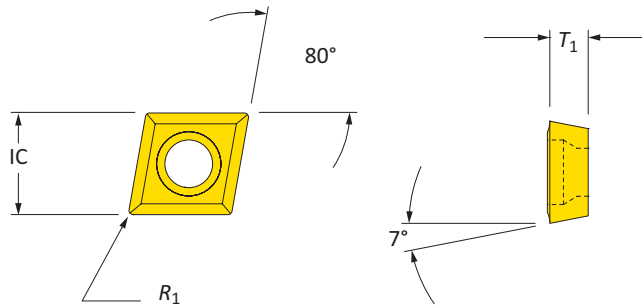

### Coated 80° Diamond Inserts

Insert Form	Insert			Part No.
	IC	$T_1$	$R_1$	
<b>i</b> CC..215..	0.250	0.094	0.008	CCMT060202
CC..215..	0.250	0.094	0.016	CCMT060204
CC..215..	0.250	0.094	0.031	CCMT060208
CC..325..	0.375	0.156	0.008	CCMT09T302
CC..325..	0.375	0.156	0.016	CCMT09T304
CC..325..	0.375	0.156	0.031	CCMT09T308

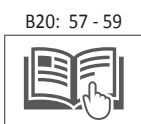
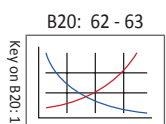

**i** = Imperial (in)  
**m** = Metric (mm)  
 Inserts sold separately

## CB206F Versatile Boring Head

Bore Diameter Range: 0.500" - 21.500"

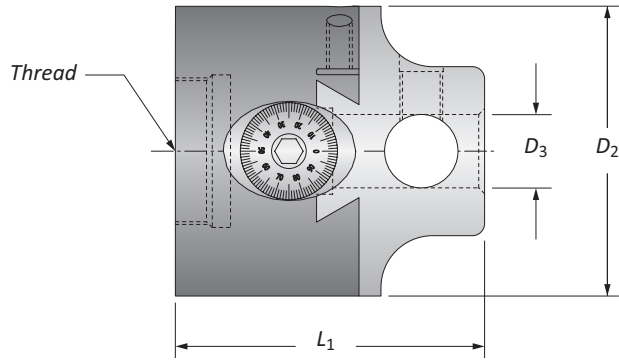

	Boring Range	Connection	Boring Head			Weight	Part No.
			$L_1$	$D_2$	$D_3$		
<b>i</b>	0.500 - 21.500	2 ¼ - 10	5.475	6.000	1.500	26.400 (lbs)	<b>CB206F</b>

**NOTICE:** Cross hole bars should always be secured in the bar holder with at least two set screws

Imperial (in) = 0.001" adjustment on diameter

**NOTE:** Max spindle speed: 500 RPM at 0 radial offset

A DRILLING  
B BORING  
C REAMING  
D BURNISHING  
E THREADING  
X SPECIALS

B20: 62 - 63    B20: 50 - 54    B20: 48 - 49    B20: 57 - 59

Key on B20: 1

**i** = Imperial (in)  
**m** = Metric (mm)

**IMPORTANT:** Max spindle speed refers to maximum possible speed for individual boring head and is not a recommended parameter. Refer to page B20: 62 for recommended application specific parameters. Factory technical assistance is available for your specific applications through our Application Engineering department.  
ext: 7611 | email: [appeng@alliedmachine.com](mailto:appeng@alliedmachine.com)

**WARNING** Exceeding weight capacity for machine tool spindle and tool changer can cause machine damage and/or serious injury. To prevent:  
- Refer to page B20: 61 to see formula for calculating weight of tool assembly.  
- Consult machine tool builder for machine's weight limitations.  
Factory technical assistance is also available for specific applications through our Application Engineering department.



## Boring Bars

Bore Diameter Range: 0.500" - 9.125"

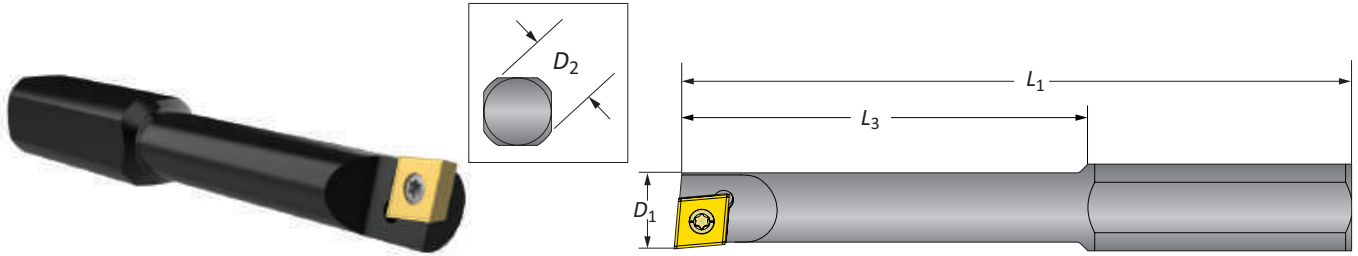

### Steel Boring Bars | Bore Diameter Range: 0.500" - 9.125"

Min. Boring Diameter	Boring Bar				Weight	Insert Form	Part No.
	$D_1$	$L_3$	$L_1$	$D_2$			
<b>i</b> 0.500	2.500	4.250	0.750*	0.280 (lbs)	CC..215..	<b>0500D</b>	
0.750	3.000	4.687	0.750*	0.430 (lbs)	CC..325..	<b>0750D</b>	
1.000	3.500	5.125	0.750*	0.510 (lbs)	CC..325..	<b>1000D</b>	
1.250	4.000	5.562	0.750*	0.570 (lbs)	CC..325..	<b>1250D</b>	

\*Reducing sleeve required

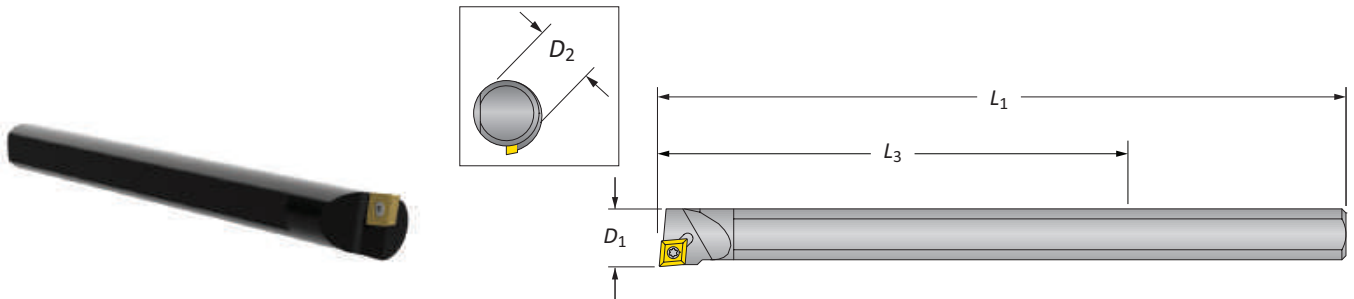

### Heavy Metal Boring Bar | Bore Diameter Range: 0.832" - 7.125"

Min. Boring Diameter	Boring Bar				Weight	Insert Form	Part No.
	$D_1$	$L_3$	$L_1$	$D_2$			
<b>i</b> 0.832	4.750	10.000	0.750*	1.150 (lbs)	CC..325..	<b>0832DHM</b>	

\*Reducing sleeve required

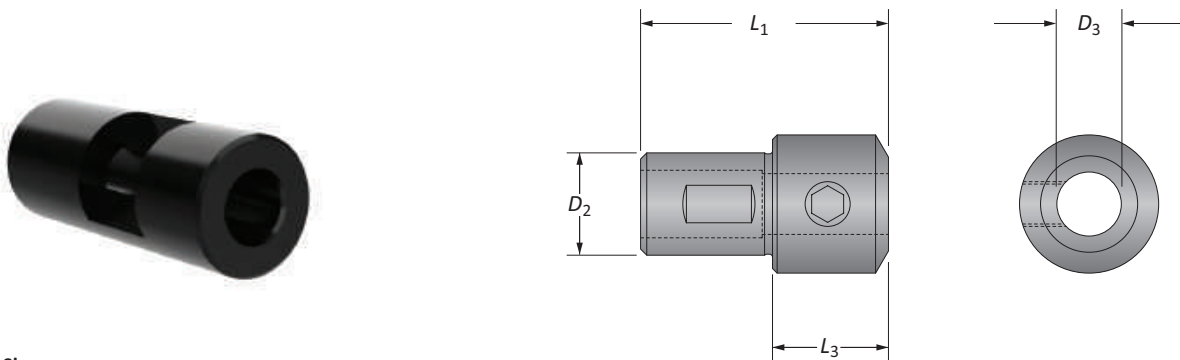

### Reducing Sleeve

Min. Boring Diameter	Reducing Sleeve				Weight	Part No.
	$D_3$	$D_2$	$L_1$	$L_3$		
<b>i</b> 0.750	1.500	3.000	1.000	1.400 (lbs)	<b>BTH-07501500</b>	

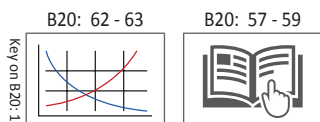

**i** = Imperial (in)  
**m** = Metric (mm)  
 Inserts sold separately

## Carbide Boring Bar

Bore Diameter Range: 0.875" - 7.125"

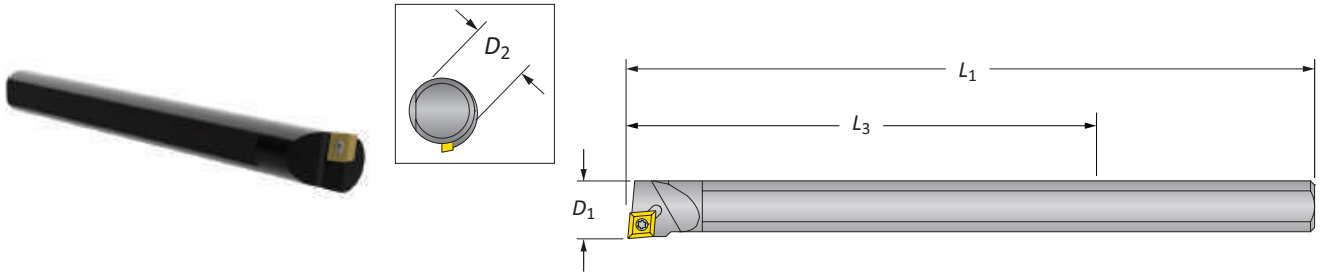

### Carbide Boring Bar

Min. Boring Diameter	Boring Bar			Weight	Insert Form	Part No.
	$D_1$	$L_3$	$L_1$			
<b>i</b> 0.875	6.000	10.000	0.750*	1.130 (lbs)	CC..325..	<b>0875DCS</b>

\*Reducing sleeve required

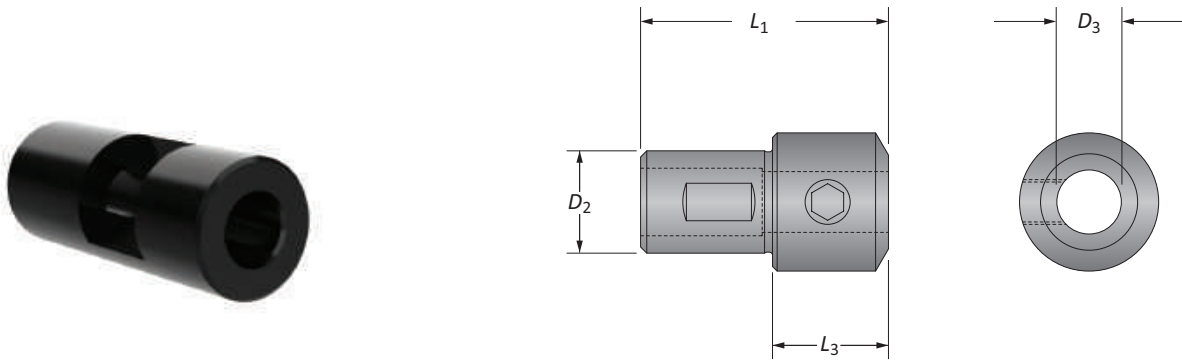

### Reducing Sleeve

Reducing Sleeve				Weight	Part No.
$D_3$	$D_2$	$L_1$	$L_3$		
<b>i</b> 0.750	1.500	3.000	1.000	1.400 (lbs)	<b>BTH-07501500</b>

B20: 62 - 63

B20: 57 - 59

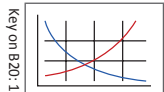

**i** = Imperial (in)  
**m** = Metric (mm)  
 Inserts sold separately

## Cross Hole Boring Bar | Boring Inserts

Bore Diameter Range: 9.093" - 21.500"

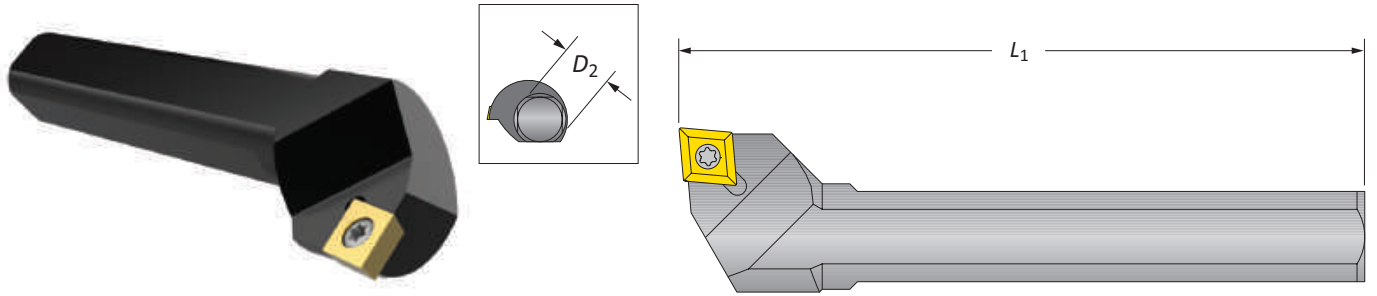

### Cross Hole Boring Bar

Min. Boring Diameter	Boring Bar*		Weight	Insert Form	Part No.
	$L_1$	$D_2$			
<b>i</b> 9.093	9.125	1.500	4.130 (lbs)	CC..43..	1500FCH

\*NOTICE: Cross hole bars should always be secured in the bar holder with at least two set screws

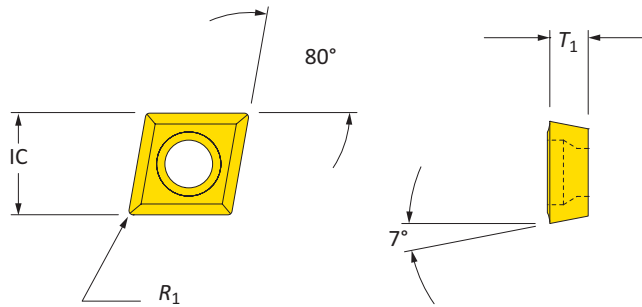

### Coated 80° Diamond Inserts

Insert Form	Insert			Part No.
	IC	$T_1$	$R_1$	
<b>i</b> CC..215..	0.250	0.094	0.008	CCMT060202
CC..215..	0.250	0.091	0.016	CCMT060204
CC..215..	0.250	0.094	0.031	CCMT060208
CC..325..	0.375	0.156	0.008	CCMT09T302
CC..325..	0.375	0.156	0.016	CCMT09T304
CC..325..	0.375	0.156	0.031	CCMT09T308
CC..43..	0.500	0.188	0.031	CCMT120408

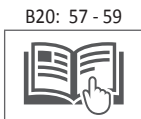
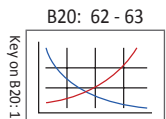

**i** = Imperial (in)  
**m** = Metric (mm)  
 Inserts sold separately

A DRILLING  
 B BORING  
 C REAMING  
 D BURNISHING  
 E THREADING  
 X SPECIALS





## Intermediate Modules

### Reducers

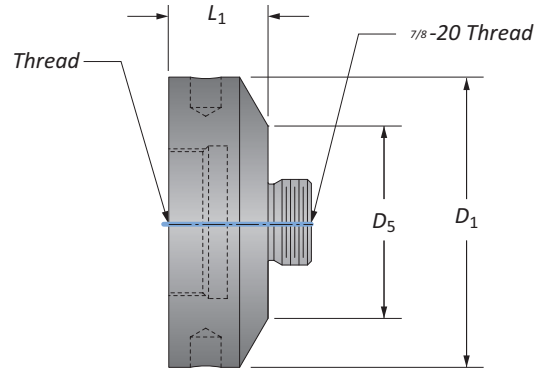

Reducer					
$D_1$	$D_5$	$L_1$	Weight	Thread	Part No.
1.500	1.000	1.000	0.440 (lbs)	$7/8 - 20$	CB1500-IRCB1000
1.500	1.250	1.000	0.450 (lbs)	$7/8 - 20$	CB1500-IRCB1250
2.000	1.000	1.000	0.720 (lbs)	$7/8 - 20$	CB2000-IRCB1000
2.000	1.250	1.000	0.760 (lbs)	$7/8 - 20$	CB2000-IRCB1250
<b>i</b> 2.000	1.500	1.000	0.800 (lbs)	$7/8 - 20$	CB2000-IRCB1500
3.000	1.000	1.250	1.610 (lbs)	$1\frac{1}{2} - 18$	CB3000-IRCB1000
3.000	1.250	1.250	1.750 (lbs)	$1\frac{1}{2} - 18$	CB3000-IRCB1250
3.000	1.500	1.250	1.840 (lbs)	$1\frac{1}{2} - 18$	CB3000-IRCB1500
3.000	2.000	1.250	2.020 (lbs)	$1\frac{1}{2} - 18$	CB3000-IRCB2000

A DRILLING

B BORING

C REAMING

D BURNISHING

F THREADING

X SPECIALS

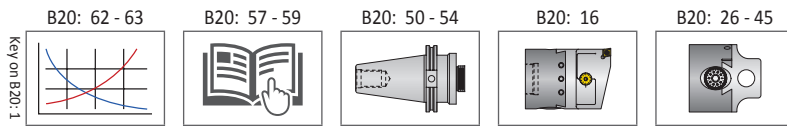

**i** = Imperial (in)  
**m** = Metric (mm)

**WARNING** Exceeding weight capacity for machine tool spindle and tool changer can cause machine damage and/or serious injury. To prevent:  
 - Refer to page B20: 61 to see formula for calculating weight of tool assembly.  
 - Consult machine tool builder for machine's weight limitations.  
 Factory technical assistance is also available for specific applications through our Application Engineering department. ext: 7611 | email: [appeng@alliedmachine.com](mailto:appeng@alliedmachine.com)

**WARNING** Tool failure can cause serious injury. To prevent:  
 - Do not exceed recommended 9xD length to diameter ratio or exceed 4 total components (including shank)  
 - Refer to example on page B20: 60 for calculating length to diameter ratio  
 Factory technical assistance is available for your specific applications through our Application Engineering department.

Intermediate Modules

Extensions

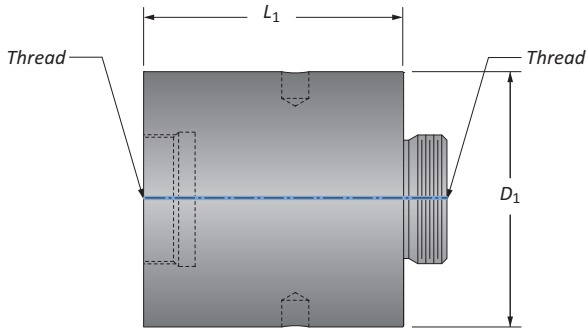

Extension				
$D_1$	$L_1$	Weight	Thread	Part No.
1.000	1.000	0.190 (lbs)	$\frac{3}{8}$ - 20	CB1000-IA1000
1.000	2.000	0.390 (lbs)	$\frac{3}{8}$ - 20	CB1000-IA2000
1.250	1.250	0.390 (lbs)	$\frac{3}{8}$ - 20	CB1250-IA1250
1.250	2.500	0.800 (lbs)	$\frac{3}{8}$ - 20	CB1250-IA2500
1.500	1.500	0.700 (lbs)	$\frac{3}{8}$ - 20	CB1500-IA1500
1.500	3.000	1.410 (lbs)	$\frac{3}{8}$ - 20	CB1500-IA3000
2.000	2.000	1.660 (lbs)	$\frac{3}{8}$ - 20	CB2000-IA2000
2.000	4.000	3.350 (lbs)	$\frac{3}{8}$ - 20	CB2000-IA4000
3.000	3.000	5.730 (lbs)	1½ - 18	CB3000-IA3000
3.000	6.000	11.500 (lbs)	1½ - 18	CB3000-IA6000

i

Key on B20: 1

B20: 62 - 63

B20: 57 - 59

B20: 50 - 54

B20: 16

B20: 26 - 45

i = Imperial (in)  
 m = Metric (mm)

**⚠ WARNING** Exceeding weight capacity for machine tool spindle and tool changer can cause machine damage and/or serious injury. To prevent:  
 - Refer to page B20: 61 to see formula for calculating weight of tool assembly.  
 - Consult machine tool builder for machine's weight limitations.  
 Factory technical assistance is also available for specific applications through our Application Engineering department. ext: 7611 | email: [appeng@alliedmachine.com](mailto:appeng@alliedmachine.com)

**⚠ WARNING** Tool failure can cause serious injury. To prevent:  
 - Do not exceed recommended 9xD length to diameter ratio or exceed 4 total components (including shank)  
 - Refer to example on page B20: 60 for calculating length to diameter ratio  
 Factory technical assistance is available for your specific applications through our Application Engineering department.

A  
 DRILLING  
 B  
 BORING  
 C  
 REAMING  
 D  
 BURNISHING  
 E  
 THREADING  
 X  
 SPECIALS

## Criterion Master Shanks

CAT 40/50 | BT Flange

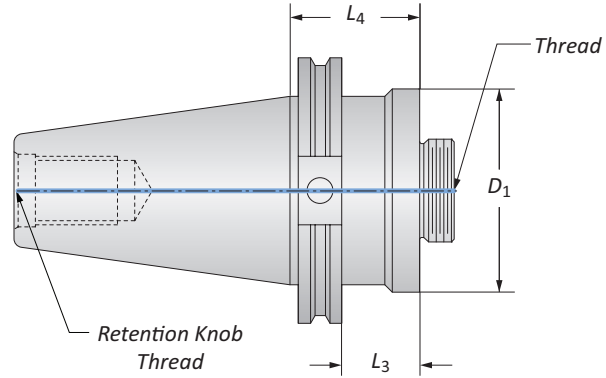

### CAT 40/50 Shanks

Style	D <sub>1</sub>	L <sub>3</sub>	Shank				Retention Knob Thread	Part No.
			L <sub>4</sub>	Weight	Thread	Retention Knob Thread		
CAT40	1.500	0.370	1.770	2.490 (lbs)	7/8 - 20	7/8 - 11	CB1500-CV40	
CAT40	2.000	1.130	1.880	2.700 (lbs)	7/8 - 20	7/8 - 11	CB2000-CV40	
CAT40	2.500	1.130	1.880	3.120 (lbs)	1 1/2 - 18	7/8 - 11	CB2500-CV40	
CAT40	3.000	1.180	1.880	3.410 (lbs)	1 1/2 - 18	7/8 - 11	CB3000-CV40	
<b>i</b> CAT50	1.500	0.370	1.770	7.120 (lbs)	7/8 - 20	1 - 8	CB1500-CV50	
CAT50	2.000	1.130	1.880	7.330 (lbs)	7/8 - 20	1 - 8	CB2000-CV50	
CAT50	2.500	1.130	1.880	7.740 (lbs)	1 1/2 - 18	1 - 8	CB2500-CV50	
CAT50	3.000	1.130	1.880	8.030 (lbs)	1 1/2 - 18	1 - 8	CB3000-CV50	
CAT50	3.380	1.380	2.130	9.440 (lbs)	2 1/4 - 10	1 - 8	CB6000-CV50	

**NOTE:** Taper ground to AT3 tolerance

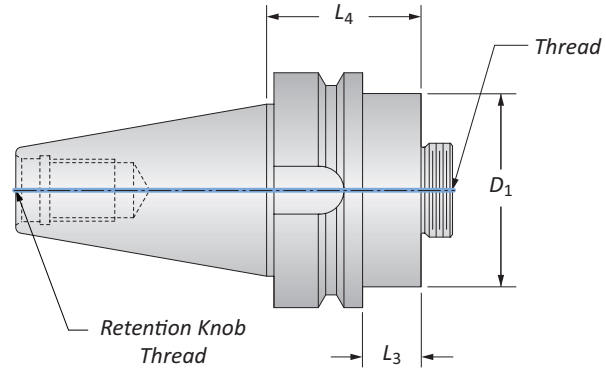

### BT Flange Shanks

Style	D <sub>1</sub>	L <sub>3</sub>	Shank				Retention Knob Thread	Part No.
			L <sub>4</sub>	Weight	Thread	Retention Knob Thread		
BT30	1.500	0.900	1.770	1.360 (lbs)	7/8 - 20	M12 x 1.75	CB1500-BT30	
BT40	1.500	0.710	1.770	2.540 (lbs)	7/8 - 20	M16 x 2	CB1500-BT40	
BT40	2.000	0.500	1.560	2.620 (lbs)	7/8 - 20	M16 x 2	CB2000-BT40	
BT40	2.500	0.870	2.060	3.690 (lbs)	1 1/2 - 18	M16 x 2	CB2500-BT40	
<b>i</b> BT40	3.000	1.000	2.060	3.980 (lbs)	1 1/2 - 18	M16 x 2	CB3000-BT40	
BT50	1.500	0.270	1.770	8.220 (lbs)	7/8 - 20	M24 x 3	CB1500-BT50	
BT50	2.000	0.060	1.560	8.250 (lbs)	7/8 - 20	M24 x 3	CB2000-BT50	
BT50	3.000	0.500	2.060	9.410 (lbs)	1 1/2 - 18	M24 x 3	CB3000-BT50	
BT50	3.380	0.630	2.130	10.500 (lbs)	2 1/4 - 10	M24 x 3	CB6000-BT50	

**NOTE:** Taper ground to AT3 tolerance

X SPECIALS

B20: 62 - 63

B20: 57 - 59

B20: 48 - 49

B20: 16

B20: 26 - 45

Key on B20: 1

**i** = Imperial (in)  
**m** = Metric (mm)



## Criterion Master Shanks

HSK | Straight Shank

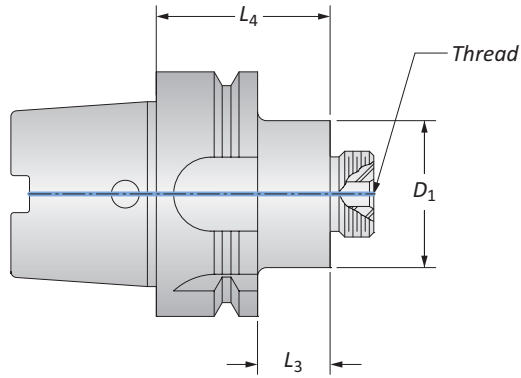

### HSK Shanks

Style	D <sub>1</sub>	Shank			Weight	Thread	Part No.
		L <sub>3</sub>	L <sub>4</sub>				
i	HSK63	1.500	0.730	1.750	1.820 (lbs)	7/8 - 20	CB1500-HSK63A
	HSK63	2.000	0.730	1.750	2.090 (lbs)	7/8 - 20	CB2000-HSK63A
	HSK63	3.000	0.500	2.150	3.200 (lbs)	1 1/2 - 18	CB3000-HSK63A
	HSK100	1.500	0.500	2.270	6.300 (lbs)	7/8 - 20	CB1500-HSK100A
	HSK100	2.000	0.500	2.270	6.470 (lbs)	7/8 - 20	CB2000-HSK100A
	HSK100	3.000	0.500	2.270	7.180 (lbs)	1 1/2 - 18	CB3000-HSK100A

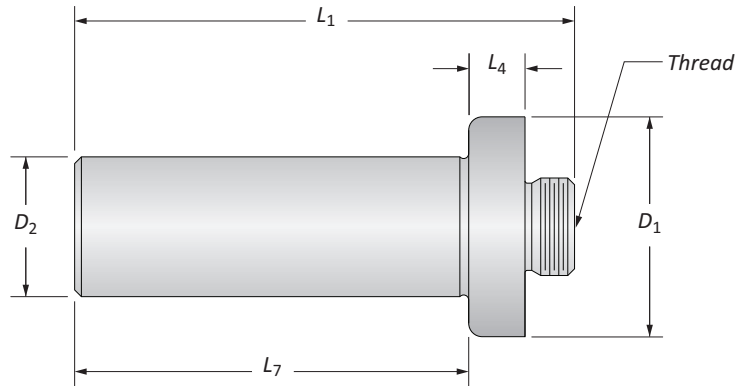

### Straight Shanks

D <sub>1</sub>	D <sub>2</sub>	Shank			Weight	Thread	Part No.
		L <sub>4</sub>	L <sub>7</sub>	L <sub>1</sub>			
i	1.110	0.500	0.250	2.000	2.690	7/8 - 20	SS0500-087520
	1.110	0.625	0.250	2.370	3.060	7/8 - 20	SS0625-087520
	1.110	0.750	0.250	2.750	3.440	7/8 - 20	SS0750-087520
	1.110	1.000	0.250	3.120	3.810	7/8 - 20	SS1000-087520
	1.860	0.750	0.250	3.120	3.870	1 1/2 - 18	SS0750-150018
	1.860	1.000	0.250	3.120	3.870	1 1/2 - 18	SS1000-150018
	1.860	1.250	0.250	3.880	4.630	1 1/2 - 18	SS1250-150018
	1.860	1.500	0.250	4.630	5.380	1 1/2 - 18	SS1500-150018
	2.000	2.000	-	6.380	6.880	1 1/2 - 18	SS2000-150018

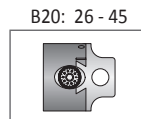
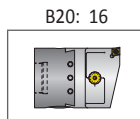
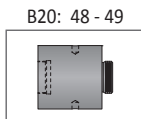
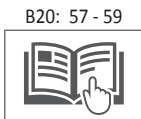
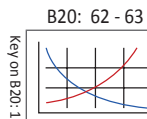

Key on B20: 1

i = Imperial (in)  
m = Metric (mm)

## Criterion Shanks

R-8 | Morse Taper

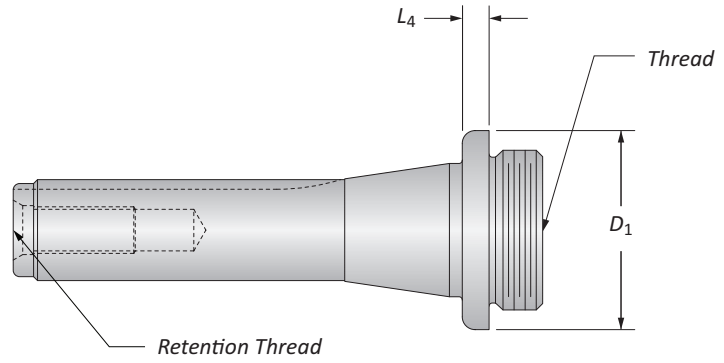

### R-8 Shanks

		Shank					
		$D_1$	$L_4$	Weight	Thread	Retention Thread	Part No.
i		1.110	0.470	0.990 (lbs)	$\frac{7}{8}$ - 20	$\frac{7}{16}$ - 20	<b>R8-087520</b>
		1.860	0.370	1.270 (lbs)	1- $\frac{1}{2}$ - 18	$\frac{7}{16}$ - 20	<b>R8-150018</b>

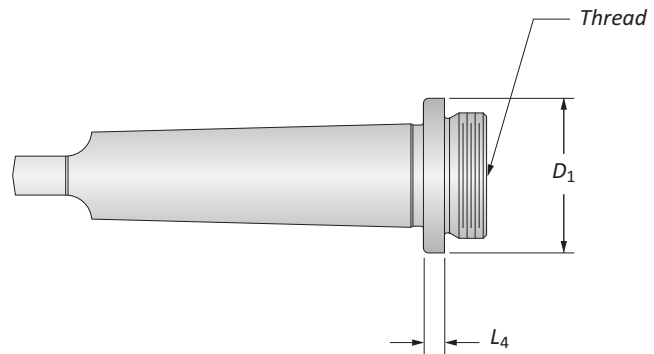

### Morse Taper Shanks

		Shank					
		Style	$D_1$	$L_4$	Weight	Thread	Part No.
i		2 Taper	1.110	0.250	0.380 (lbs)	$\frac{7}{8}$ - 20	<b>MT2-375THD87520*</b>
		2 Taper	1.110	0.250	0.390 (lbs)	$\frac{7}{8}$ - 20	<b>MT2-087520</b>
		3 Taper	1.110	0.250	0.710 (lbs)	$\frac{7}{8}$ - 20	<b>MT3-087520</b>
		3 Taper	1.860	0.250	1.000 (lbs)	1- $\frac{1}{2}$ - 18	<b>MT3-150018</b>
		4 Taper	1.230	0.250	1.350 (lbs)	$\frac{7}{8}$ - 20	<b>MT4-087520</b>
		4 Taper	1.860	0.250	1.700 (lbs)	1- $\frac{1}{2}$ - 18	<b>MT4-150018</b>
		5 Taper	1.860	0.250	3.770 (lbs)	1- $\frac{1}{2}$ - 18	<b>MT5-150018</b>

\*Item features a  $\frac{3}{8}$  - 16 thread instead of tang

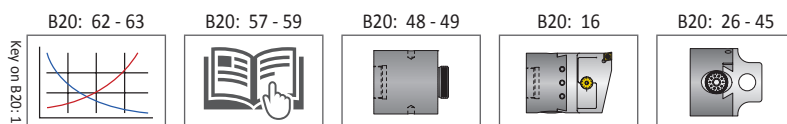

i = Imperial (in)  
m = Metric (mm)

## Criterion Master Shanks

NMTB Taper | DIN69871A

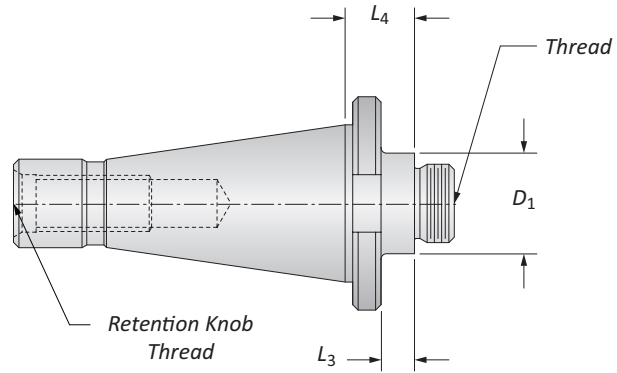

### NMTB Taper Shanks

Style	$D_1$	$L_3$	$L_4$	Shank			Part No.
				Weight	Thread	Retention Thread	
NMTB 30	1.120	0.370	0.790	0.810 (lbs)	$\frac{7}{8}$ - 20	$\frac{1}{2}$ - 13	NMTB30-087520
NMTB 30	1.850	0.630	1.050	1.190 (lbs)	$1\frac{1}{2}$ - 18	$\frac{1}{2}$ - 13	NMTB30-150018
NMTB 40	1.120	0.370	0.770	1.780 (lbs)	$\frac{7}{8}$ - 20	$\frac{5}{8}$ - 11	NMTB40-087520
NMTB 40	1.850	0.630	1.020	2.310 (lbs)	$1\frac{1}{2}$ - 18	$\frac{5}{8}$ - 11	NMTB40-150018
NMTB 50	1.970	0.510	1.250	6.750 (lbs)	$\frac{7}{8}$ - 20	1 - 8	NMTB50-087520
NMTB 50	1.870	0.400	1.210	6.870 (lbs)	$1\frac{1}{2}$ - 18	1 - 8	NMTB50-150018
NMTB 50	3.380	0.500	1.250	8.320 (lbs)	$2\frac{1}{4}$ - 10	1 - 8	NMTB50-225010

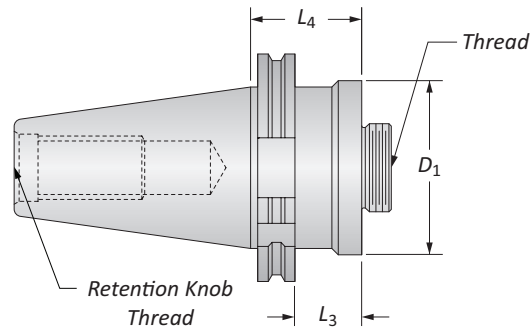

### DIN 69871A

$D_1$	$L_3$	$L_4$	Shank			Part No.
			Weight	Thread	Retention Thread	
38.00	19.00	38.40	1.18 (kg)	$\frac{7}{8}$ - 20	M16 x 2.0	CB038M-DIN40
50.00	22.00	41.50	1.18 (kg)	$\frac{7}{8}$ - 20	M16 x 2.0	CB050M-DIN40
76.00	45.00	48.00	1.68 (kg)	$1\frac{1}{2}$ - 18	M16 x 2.0	CB076M-DIN40
38.00	19.00	38.40	3.36 (kg)	$\frac{7}{8}$ - 20	M24 x 3.0	CB038M-DIN50
50.00	22.00	41.50	3.45 (kg)	$\frac{7}{8}$ - 20	M24 x 3.0	CB050M-DIN50
76.00	22.00	48.00	3.66 (kg)	$1\frac{1}{2}$ - 18	M24 x 3.0	CB076M-DIN50

**NOTE:** Taper ground to AT3 tolerance

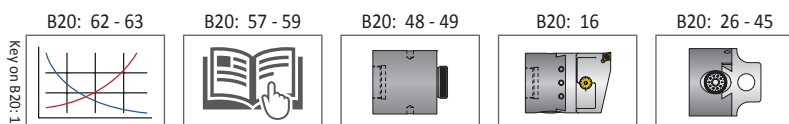

**i** = Imperial (in)  
**m** = Metric (mm)

## Criterion Shanks

DIN 2080

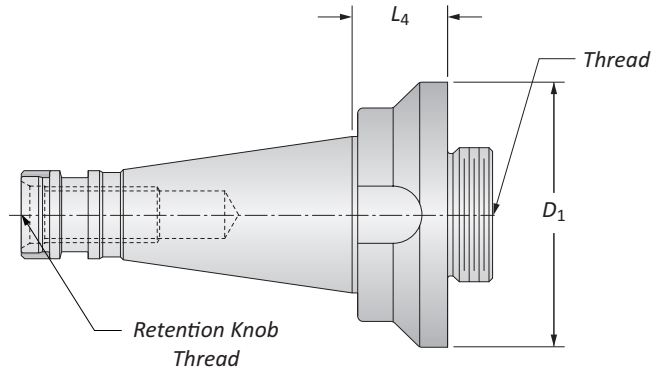

DIN 2080

		Shank					Part No.	
		$D_1$	$L_3$	$L_4$	Weight	Thread	Retention Thread	
m		50.00	17.00	25.70	0.45 (kg)	$\frac{7}{8}$ - 20	M12	CB050M-ISO30
		50.00	11.00	27.70	0.91 (kg)	$\frac{7}{8}$ - 20	M16	CB050M-ISO40
		76.00	22.00	27.70	1.32 (kg)	1½ - 18	M16	CB076M-ISO40
		50.00	11.00	39.40	2.88 (kg)	$\frac{7}{8}$ - 20	M24	CB038M-ISO50
		76.00	36.00	39.40	3.36 (kg)	1½ - 18	M24	CB076M-ISO50

A DRILLING

B BORING

C REAMING

D BURNISHING

F THREADING

X SPECIALS

Key on B20: 1

B20: 62 - 63

B20: 57 - 59

B20: 48 - 49

B20: 16

B20: 26 - 45





i = Imperial (in)  
m = Metric (mm)





## Criterion Accessories

Insert Screws | Drivers | Pin Spanner Wrenches

### Insert Screws & Drivers

 <b>Insert Form</b>	 <b>Part No.</b>	 <b>Thread</b>	 <b>Part No.</b>	<b>Technical Information</b>	
				<b>Torque Specs</b>	<b>Key Size</b>
WBGX0301..	<b>215377</b>	M2x4	<b>115537</b>	0.6 (Nm)	T6
CC..215.. CC..0602..	<b>115676</b>	M2.5x5	<b>115590</b>	1.2 (Nm)	T8
CC..32500 CC..09T3 (<Ø37mm)	<b>115672</b>	M3.5x7.5	<b>115664</b>	3.0 (Nm)	T15
CC..32500 CC..09T3 (<Ø36mm)	<b>115673</b>	M3.5x9	<b>115664</b>	3.0 (Nm)	T15
CC..43.. CC..1204..	<b>215149</b>	M4.5x11.5	<b>215150</b>	5.0 (Nm)	T20
TC..215.. TC..1102..	<b>115676</b>	M2.5x5	<b>115590</b>	1.2 (Nm)	T8
TC..325.. TC..16T3	<b>115673</b>	M3.5x9	<b>115664</b>	3.0 (Nm)	T15

### Pin Spanner Wrenches

 <b>Body Diameter</b>	<b>Pin Spanner Wrench</b>  <b>Part No.</b>
1.000" (25.00mm)	<b>CB1000-PSW</b>
1.250" (32.00mm)	<b>CB1250-PSW</b>
1.500" (38.00mm)	<b>CB1500-PSW</b>
2.000" (38.00mm)	<b>CB2000-PSW</b>
2.500" (63.50mm)	<b>CB2500-PSW</b>
3.000" (76.00mm)	<b>CB3000-PSW</b>
4.000" (101.00mm)	<b>CB4000-PSW</b>

B20: 62 - 63

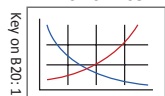

B20: 56 - 57



A DRILLING  
B BORING  
C REAMING  
D BURNISHING  
E THREADING  
X SPECIALS

## Criterion Hardware Kits

Corresponding Boring Head Item Number	Hardware Kit Part No.
CBR-0625CP, CBR-0628TP, CBR-0625SG, CBS-0625CP, CBS-0625TP, CBS-0625SG, CBER16S-SG, CBR16-SG, CBER20S-SG, CBER20-SG, CBER16MS-CP, CBR16M-CP, CBER16MS-TP, CBR16M-TP, CBER20MS-CP, CBER20M-CP, CBER20MS-TP, CBER20M-TP, CBER16S-CP, CBR16-CP, CBER16S-TP, CBR16-TP, CBER20S-CP, CBER20-CP, CBER20S-TP, CBER20-TP	<b>CB0625-HDW</b>
CBS-0750CP, CBS-0750TP, CBS-0750SH, CBR-0750CP, CBR-0750TP, CBR-0750SH, CBER25S-SH, CBER25-SH, CBER25S-CP, CBER25-CP, CBER25S-TP, CBER25-TP, CBER25-TP, CBER25MS-CP, CBER25M-CP, CBER25MS-TP	<b>CB0750-HDW</b>
TMT-0750H, TMT-1000H	<b>TMT0750-HDW</b>
CB1000CC, CB1000TC CBS-1000CP, CBS-1000TP, CBS-1000CPMA, CBS-1000TPMA, CBS-1000SA, CBR-1000CP, CBR-1000TP, CBR-1000CPMA, CBR-1000TPMA, CBR-1000SA, CBER32S-CPMA, CBER32-CPMA, CBER32S-TPMA, CBER32-TPMA, CBER32MS-CPMA, CBER32M-CPMA, CBER32MS-TPMA, CBER32M-TPMA, CBER32S-SA, CBER32-SA, CBER32S-CP, CBER32-CP, CBER32S-TP, CBER32-TP, CBER32MS-CP, CBER32M-CP, CBER32MS-TP, CBER32M-TP, CB1000-TPMA, CB1000-CPMA, CB1000-TP, CB1000-CP	<b>CB1000-HDW</b>
CT1000-0, CT1000-1, CT1000-2	<b>CT1000-HDW</b>
CB025MCC, CB025MTC, CB025M-TPMA, CB025M-CPMA, CB025M-TP, CB025M-CP	<b>CB025M-HDW</b>
CT025M-0, CT025M-1, CT025M-2	<b>CT025M-HDW</b>
CBS1250B, CB1250CC, CB1250TC, CBS-1250CP, CBS-1250TP, CBS-1250CPMA, CBS-1250TPMA, CBS-1250SB, CBR-1250CP, CBR-1250TP, CBR-1250CPMA, CBR-1250TPMA, CBR-1250SB, CBER40S-CPMA, CBER40-CPMA, CBER40S-TPMA, CBER40-TPMA, CBER40S-CPMA, CBER40M-CPMA, CBER40MS-TPMA, CBER40M-TPMA, CBER40S-SB, CBER40-SB, CBER40S-CP, CBER40-CP, CBER40S-TP, CBER40-TP, CBER40MS-CP, CBER40M-CP, CBER40MS-TP, CBER40M-TP, CB1250-TPMA, CB1250-CPMA, CB1250-TP, CB1250-CP	<b>CB1250-HDW</b>
CT1250-0, CT1250-1, CT1250-2	<b>CT1250-HDW</b>
CB032MCC, CB032MTC, CB032M-TPMA, CB032M-CPMA, CB032M-TP, CBO32M-CP	<b>CB032M-HDW</b>
CT032M-0, CT032M-1, CT032M-2	<b>CT032M-HDW</b>
MBS0500B, CB1500CC, CB1500TC, MB002-500, MB002-625, MB002-750, MB152-500, MB152-625, MB152-750, CB-2375A, CB-1500B, CB-1500AMA, CB1500-TPMA, CB1500-CPMA, CB1500-TP, CB1500-CP	<b>CB1500-HDW</b>
CT1500-0, CT1500-1, CT1500-2	<b>CT1500-HDW</b>
SQ-1500B	<b>S1500-HDW</b>
CB038MCC, CB038MTC, CB-038MA, CB-038MB, CB038M-TPMA, CB038M-CPMA, CB038M-TP, CB038M-CP	<b>CB038-HDW</b>
CT038M-0, CT038M-1, CT038-2	<b>CT038M-HDW</b>
SQ-2000B	<b>S2000-HDW</b>
CB2000CC, CB2000TC, CB202B, CB2500BMA CSL-202, CB-202A, CB-202B, CB-2500BMA, CB2000-TPMA, CB2000-CPMA, CB050M-TP, CB050M-CP	<b>CB2000-HDW</b>
CT2000-0, CT2000-1, CT2000-2	<b>CT2000-HDW</b>
CB050MCC, CB050MTC, CB-050MA, CB-050MB, CB-064MBMA, CB050M-TPMA, CB050M-TPMA, CB050M-TPMA, CB050M-CPMA, CB050M-TP, CP050M-CP	<b>CB050M-HDW</b>
CT050M-0, CT050M-1, CT050M-2	<b>CT050M-HDW</b>
SQ-3000D, SQ-3000E	<b>S3000-HDW</b>
CB3000CC, CB3000TC, CB203D, CSL-203, CB-203D, CB-3000DMA, CB3000-TPMA, CB3000-CPMA, CB3000-TP, CB3000-CP	<b>CB3000-HDW</b>
CT3000-0, CT3000-1, CT3000-2	<b>CT3000-HDW</b>
CB076MCC, CB076MTC, CB-076MD, CB-076MDMA, CB076M-TPMA, CB076M-CPMA, CBO76M-TP, CB076M-CP	<b>CB076M-HDW</b>
CT076M-0, CT076M-1, CT076M-2	<b>CT076M-HDW</b>
CB204E, CSL-204, CB-204E, CB4000-TP, CB4000-TP, CB4000-TP, CB4000-CP	<b>CB4000-HDW</b>
CB-101ME, CB101M-TP, CB101-CP	<b>CB101M-HDW</b>
CB206F, CB-206F	<b>CB6000-HDW</b>

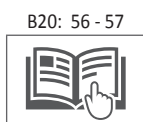
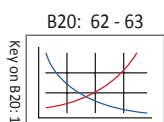

## Setup Instructions | Standard Adjusting Boring Heads

### Adjusting Standard Adjusting Boring Heads (see figure B1)

1. Loosen locking screw (6).
2. Turn dial screw (3) to desired graduation.
3. Tighten locking screw (6) to proper torque spec (laser marked on tool).

**IMPORTANT:** Do not loosen the gib screws (5). It can cause poor performance.

**NOTE:** To machine smaller bore diameters, turn dial screw (3) counterclockwise one full rotation to remove any backlash. Once backlash is mitigated, turn dial screw (3) clockwise to desired graduation.

No.	Part
1	Bar holder
2	Boring head body
3	Dial screw
4	Bar holder set screws
5	Gib screws (DO NOT ADJUST)
6	Locking screw

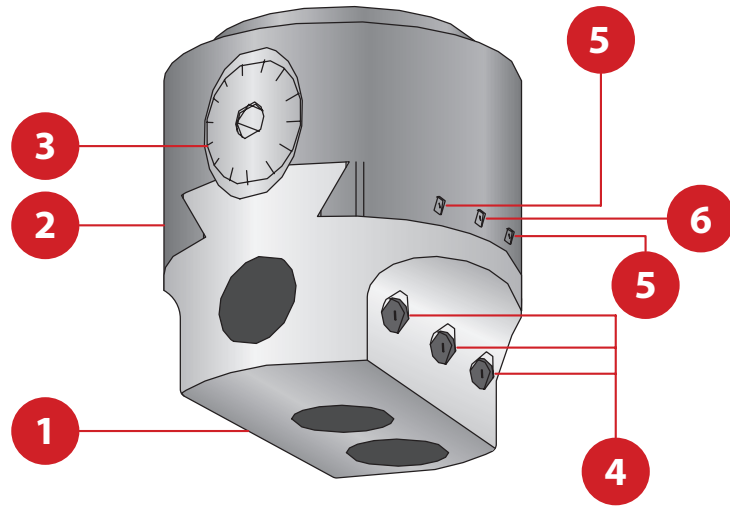
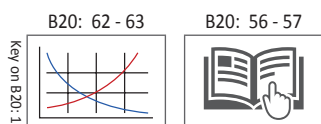

Figure B1





**Setup Instructions | Micro Adjusting Boring Heads**

**Adjusting Micro Adjusting Setting Boring Heads (see figure B2)**

1. Loosen locking screw (6).
2. Turn dial screw (3) to desired graduation to make macro adjustment.
3. Tighten locking screw (6) to proper torque spec (laser marked on tool).
4. Turn micro adjusting dial screw (4) clockwise to desired graduation to make micro adjustment. Locking of micro adjustment dial screw (4) is not required.

**IMPORTANT:** Do not loosen the gib screws (5). It can cause poor performance.

**NOTE:** To machine smaller bore diameter, turn dial (3) counterclockwise one full rotation to remove any backlash. Once backlash is mitigated, turn dial screw (3) clockwise to desired graduation.

**NOTE:** The micro adjusting dial screws only have a total range of 0.006" (0.152mm) on diameter. To zero, turn dial (4) clockwise until dial screw bottoms out. Turn the dial (4) two complete turns counterclockwise. Turn dial (4) one half turn clockwise. Dial is now centered for 0.003" (0.076mm) positive or negative travel.

No.	Part
1	Insert holder
2	Boring head body
3	Dial screw
4	Micro adjusting dial screw
5	Gib screws (DO NOT ADJUST)
6	Locking screw

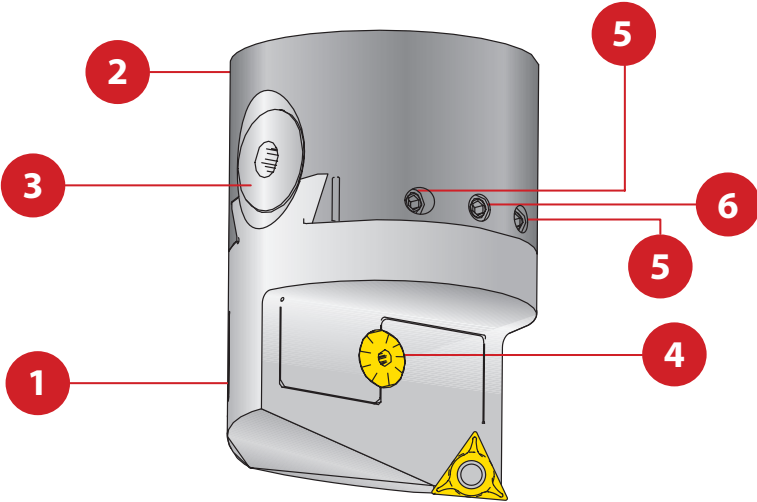
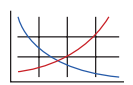



Figure B2

Key on B20-1

B20: 62 - 63



B20: 56 - 57



## Technical Information

Assembly Item Number	Lock Screw	Torque Specs				
		Locking Screw Allen Key Size	Dial Adjust Allen Key Size	Micro Adjusting Dial Allen Key Size	Clamping Screw Allen Key Size	Insert Torx Screw Driver Size
MBS0500B	1.4 (Nm)	5/64	5/32	-	1/8	-
CBS1250B	0.7 (Nm)	1/16	5/32	-	1/8	-
MDS0625	1.4 (Nm)	9/64	7/64	-	-	T8
MDS0750	1.5 (Nm)	5/32	7/64	-	-	T15
MDS16M	1.4 (Nm)	2.5mm	2.5mm	-	-	T8
MDS20M	1.5 (Nm)	3.0mm	2.5mm	-	-	T15
CB1000CC	0.6 (Nm)	0.050	5/32	3/32	-	T8
CB1000TC	0.6 (Nm)	0.050	5/32	3/32	-	T8
CB1250CC	0.7 (Nm)	1/16	5/32	3/32	-	T8
CB1250TC	0.7 (Nm)	1/16	5/32	3/32	-	T8
CB1500CC	1.4 (Nm)	5/64	5/32	7/64	-	T15
CB1500TC	1.4 (Nm)	5/64	5/32	7/64	-	T15
CB2000CC	2.3 (Nm)	3/32	5/32	7/64	-	T15
CB2000TC	2.3 (Nm)	3/32	5/32	7/64	-	T15
CB3000CC	5.3 (Nm)	1/8	1/4	7/64	-	T15
CB3000TC	5.3 (Nm)	1/8	1/4	7/64	-	T15
CB025MCC	0.6 (Nm)	1.5mm	4.0mm	2.5mm	-	T8
CB025MTC	0.6 (Nm)	1.5mm	4.0mm	2.5mm	-	T8
CB032MCC	0.7 (Nm)	2.0mm	4.0mm	2.5mm	-	T8
CB032MTC	0.7 (Nm)	2.0mm	4.0mm	2.5mm	-	T8
CB038MCC	1.4 (Nm)	2.0mm	4.0mm	3.0mm	-	T15
CB038MTC	1.4 (Nm)	2.0mm	4.0mm	3.0mm	-	T15
CB050MCC	2.3 (Nm)	2.5mm	4.0mm	3.0mm	-	T15
CB050MTC	2.3 (Nm)	2.5mm	4.0mm	3.0mm	-	T15
CB076MCC	5.3 (Nm)	3.0mm	6.0mm	3.0mm	-	T15
CB076MTC	5.3 (Nm)	3.0mm	6.0mm	3.0mm	-	T15
CB2500BMA	2.3 (Nm)	3/32	1/4	7/64	7/32	-
CB202B	2.3 (Nm)	3/32	5/32	-	5/32	-
CB203D	5.3 (Nm)	1/8	1/4	-	7/32	-
CB204E	12.4 (Nm)	5/32	1/4	-	7/32	-
CB206F	12.4 (Nm)	5/32	5/16	-	1/4	-

B20: 62 - 63

B20: 56 - 57

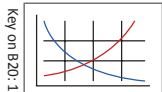

A DRILLING  
B BORING  
C REAMING  
D BURNISHING  
E THREADING  
X SPECIALS



## Guidelines for Not Exceeding Recommended Length to Diameter Ratio

To calculate, see graphics below:

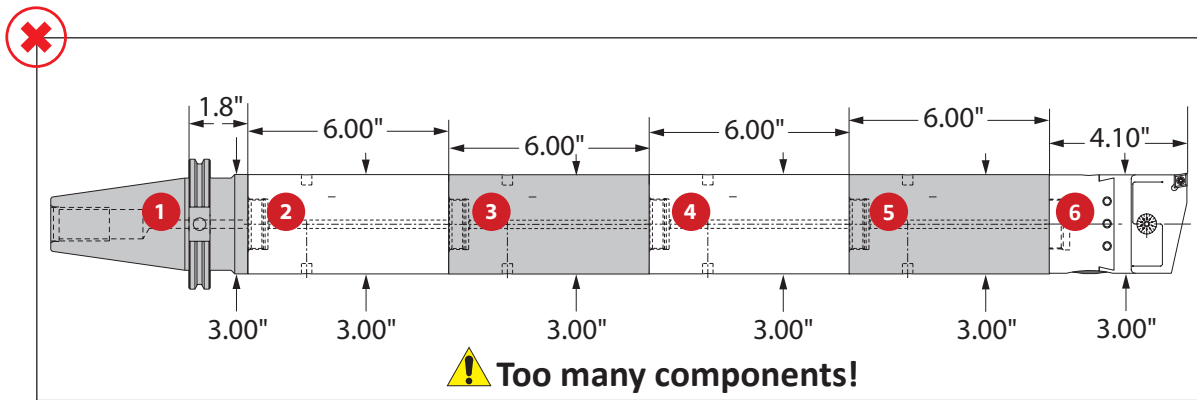

\*Length to diameter ratio is calculated using body diameters, not cutting diameter.

### Step 1: Find L : D by component

- 1  $0.6 = 1.88/3.00$
- 2  $2.0 = 6.00/3.00$
- 3  $2.0 = 6.00/3.00$
- 4  $2.0 = 6.00/3.00$
- 5  $2.0 = 6.00/3.00$
- 6  $1.4 = 4.10/3.00$

### Step 2: Add each L : D Average

	0.6
	2.0
	2.0
	2.0
	2.0
	2.0
	+ 1.4
<b>10.0 = L : D ratio</b>	

**Too Long!**

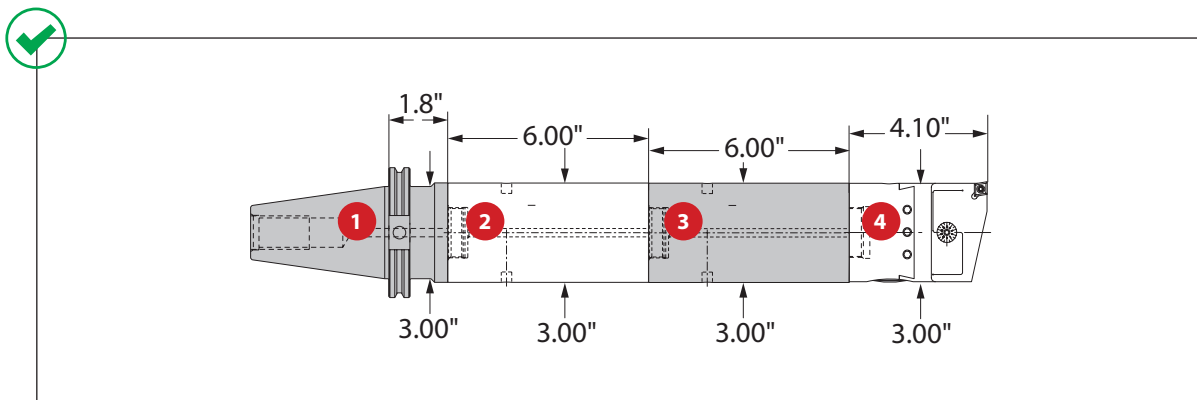

\*Length to diameter ratio is calculated using body diameters, not cutting diameter.

### Step 1: Find L : D by component

- 1  $0.6 = 1.88/3.00$
- 2  $2.0 = 6.00/3.00$
- 3  $2.0 = 6.00/3.00$
- 4  $1.4 = 4.10/3.00$

### Step 2: Add each L : D Average

	0.6
	2.0
	2.0
	+ 1.4
<b>6.0 = L : D ratio</b>	

**WARNING** Tool failure can cause serious injury. To prevent:

- Do not exceed recommended 9xD length to diameter ratio or exceed 4 total components (including shank)

Factory technical assistance is available for your specific applications through our Application Engineering department. ext: 7611 | email: [appeng@alliedmachine.com](mailto:appeng@alliedmachine.com)

### Calculating Tool Assembly Weight

To calculate, see graphics below:

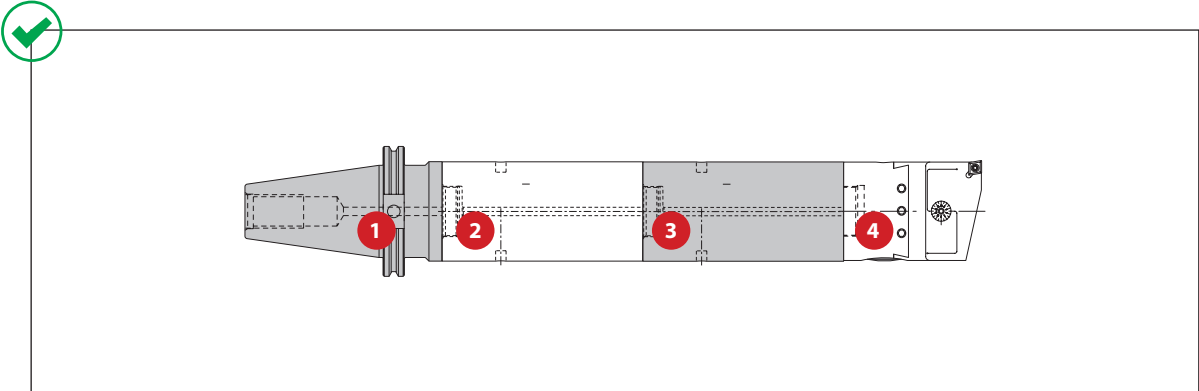

**Step 1: Find weight for each component**

**Example:**

Boring Range	Thread Connection	4 Boring Head		Weight	Insert Form	Order Number
		L <sub>1</sub>	D <sub>2</sub>			
1.050 - 1.320	¾ - 20	2.690	1.000	0.50 (lbs)	CC..215...	CB1000CC
1.050 - 1.320	¾ - 20	2.690	1.000	0.50 (lbs)	TC..215...	CB1000TC
1.300 - 1.600	¾ - 20	2.900	1.250	0.80 (lbs)	CC..215...	CB1250CC
1.300 - 1.600	¾ - 20	2.900	1.250	0.80 (lbs)	TC..215...	CB1250TC
1.585 - 2.700	¾ - 20	3.200	1.500	1.30 (lbs)	CC..325...	CB1500CC
1.585 - 2.700	¾ - 20	3.200	1.500	1.30 (lbs)	TC..325...	CB1500TC
2.060 - 3.320	¾ - 20	3.590	2.000	2.40 (lbs)	CC..325...	CB2000CC
2.060 - 3.320	¾ - 20	3.590	2.000	2.40 (lbs)	TC..325...	CB2000TC
3.065 - 5.065	1½ - 18	4.100	3.000	5.80 (lbs)	CC..325...	CB3000CC
3.065 - 5.065	1½ - 18	4.100	3.000	5.80 (lbs)	TC..325...	CB3000TC
27.00 - 33.00	¾ - 20	68.35	25	0.23 (kg)	CC..0602...	CB025MCC
27.00 - 33.00	¾ - 20	68.35	25	0.23 (kg)	TC..1102...	CB025MTC
33.00 - 41.00	¾ - 20	73.65	32	0.36 (kg)	CC..0602...	CB032MCC
33.00 - 41.00	¾ - 20	73.65	32	0.36 (kg)	TC..1102...	CB032MTC
41.00 - 68.00	¾ - 20	81.25	38	0.59 (kg)	CC..09T3...	CB038MCC
41.00 - 68.00	¾ - 20	81.25	38	0.59 (kg)	TC..16T3...	CB038MTC
53.00 - 84.00	¾ - 20	91.30	50	1.09 (kg)	CC..09T3...	CB050MCC
53.00 - 84.00	¾ - 20	91.30	50	1.09 (kg)	TC..16T3...	CB050MTC
78.00 - 128.00	1½ - 18	104.25	76	2.36 (kg)	CC..09T3...	CB076MCC
78.00 - 128.00	1½ - 18	104.25	76	2.36 (kg)	TC..16T3...	CB076MTC

Imperial (in) = 0.00005" adjustment on diameter  
 Metric (mm) = 0.001mm adjustment on diameter

**Step 2: Calculate total assembly weight**

$$\begin{array}{r}
 1 \quad 8.03 \text{ lbs} \\
 2 \quad 11.50 \text{ lbs} \\
 3 \quad 11.50 \text{ lbs} \\
 + 4 \quad 5.80 \text{ lbs} \\
 \hline
 36.83 \text{ lbs}
 \end{array}$$

**Step 3: Consult machine tool builder to ensure tool assembly weight does not exceed machine capabilities.**

**⚠ WARNING** Exceeding weight capacity for machine tool spindle and tool changer can cause machine damage and/or serious injury. To prevent:  
 - Consult machine tool builder for machine's weight limitations.  
 Factory technical assistance is also available for specific applications through our Application Engineering department. ext: 7611 | email: appeng@alliedmachine.com

## Recommended Cutting Data | Imperial (inch)

ISO	Material	(BHN) Hardness	Grade	*Speed SFM	Recommended Feed (inch / tooth)			
					Nose Radius			
					0.004"	0.008"	0.016"	0.031"
P	<b>Free Machining Steel</b> 1118, 1215, 12L14, etc.	100 - 250	Carbide	525 - 975	0.001 - 0.003	0.002 - 0.005	0.004 - 0.006	0.006 - 0.009
	<b>Low Carbon Steel</b> 1010, 1020, 1025, 1522, 1144, etc.	85 - 275	Carbide	475 - 925	0.001 - 0.002	0.002 - 0.004	0.003 - 0.005	0.005 - 0.008
	<b>Medium Carbon Steel</b> 1030, 1040, 1050, 1527, 1140, 1151, etc.	125 - 325	Carbide	475 - 825	0.001 - 0.002	0.002 - 0.004	0.003 - 0.005	0.005 - 0.008
	<b>Alloy Steel</b> 4140, 5140, 8640, etc.	125 - 375	Carbide	400 - 700	0.001 - 0.002	0.002 - 0.004	0.003 - 0.005	0.005 - 0.008
	<b>High Strength Alloy</b> 4340, 4330V, 300M, etc.	225 - 400	Carbide	325 - 600	0.001 - 0.002	0.002 - 0.004	0.003 - 0.005	0.005 - 0.008
	<b>Structural Steel</b> A36, A285, A516, etc.	100 - 350	Carbide	475 - 925	0.001 - 0.002	0.002 - 0.004	0.003 - 0.005	0.005 - 0.008
	<b>Tool Steel</b> H-13, H-21, A-4, O-2, S-3, etc.	150 - 250	Carbide	325 - 600	0.001 - 0.002	0.002 - 0.003	0.003 - 0.004	0.004 - 0.006
S	<b>High Temp Alloy</b> Hastelloy B, Inconel 600, etc.	140 - 310	Carbide	100 - 225	0.001 - 0.002	0.002 - 0.003	0.003 - 0.005	0.004 - 0.006
	<b>Titanium Alloy</b>	140 - 310	Carbide	125 - 300	0.001 - 0.002	0.002 - 0.003	0.003 - 0.005	0.004 - 0.006
	<b>Aerospace Alloy</b> S82	185 - 350	Carbide	125 - 300	0.001 - 0.002	0.002 - 0.003	0.003 - 0.005	0.004 - 0.006
M	<b>Stainless Steel 400 Series</b> 416, 420, etc.	185 - 350	Carbide	300 - 525	0.001 - 0.002	0.002 - 0.004	0.003 - 0.004	0.004 - 0.006
	<b>Stainless Steel 300 Series</b> 304, 316, 17-4PH, etc.	135 - 275	Carbide	300 - 525	0.001 - 0.002	0.002 - 0.004	0.003 - 0.004	0.004 - 0.006
	<b>Super Duplex Stainless Steel</b>	135 - 275	Carbide	300 - 525	0.001 - 0.002	0.002 - 0.004	0.003 - 0.004	0.004 - 0.006
H	<b>Wear Plate</b>	400 - 600	Carbide	100 - 200	0.001 - 0.002	0.002 - 0.003	0.003 - 0.004	0.004 - 0.006
	<b>Hardened Steel</b>	300 - 500	Carbide	125 - 275	0.001 - 0.002	0.002 - 0.003	0.003 - 0.004	0.004 - 0.006
K	<b>SG / Nodular Cast Iron</b>	120 - 320	Carbide	475 - 850	0.001 - 0.002	0.002 - 0.004	0.003 - 0.005	0.005 - 0.008
	<b>Grey / White Iron</b>	180 - 320	Carbide	600 - 1000	0.001 - 0.002	0.002 - 0.004	0.003 - 0.005	0.005 - 0.008
N	<b>Cast Aluminum</b>	30 - 180	Carbide	850 - 1000	0.001 - 0.002	0.002 - 0.004	0.003 - 0.005	0.005 - 0.008
	<b>Wrought Aluminum</b>	30 - 180	Carbide	675 - 1000	0.001 - 0.003	0.002 - 0.005	0.004 - 0.006	0.006 - 0.009
	<b>Aluminum Bronze</b>	100 - 250	Carbide	475 - 925	0.001 - 0.002	0.002 - 0.004	0.004 - 0.005	0.005 - 0.008
	<b>Brass</b>	100	Carbide	675 - 1000	0.001 - 0.002	0.002 - 0.004	0.003 - 0.005	0.005 - 0.008
	<b>Copper</b>	60	Carbide	325 - 600	0.001 - 0.002	0.002 - 0.003	0.003 - 0.004	0.004 - 0.005

\*Not to exceed max recommended RPM for boring head

### Deep Hole Boring Speed Adjustment

⚠ For Dynamic Boring Tool Length			
Boring Type	7xD	8xD	9xD
Finishing	0.70	0.50	0.30

### Recommended Speed Example

If the recommended speed for a finish boring assembly under 5xD is 400 SFM, then the speed for an 8xD finish boring assembly in the same application would be 200 SFM. (400 SFM x 0.50 = 200 SFM)	
5xD = 400 SFM	8xD = 200 SFM

**IMPORTANT:** Max spindle speed refers to maximum possible speed for individual boring head and is not a recommended parameter. Refer to page B20: 62 for recommended application specific parameters. Factory technical assistance is available for your specific applications through our Application Engineering department.  
ext: 7611 | email: [appeng@alliedmachine.com](mailto:appeng@alliedmachine.com)

### ⚠ WARNING Tool failure can cause serious injury. To prevent:

- Do not exceed recommended 9xD length to diameter ratio or exceed 4 total components (including shank)
  - Refer to example on page B20: 60 for calculating length to diameter ratio
- Factory technical assistance is available for your specific applications through our Application Engineering department.

## Recommended Cutting Data | Metric (mm)

ISO	Material	(BHN) Hardness	Grade	*Speed M/min	Recommended Feed (mm / tooth) Nose Radius			
					0.1mm	0.2mm	0.4mm	0.8mm
P	Free Machining Steel 1118, 1215, 12L14, etc.	100 - 250	Carbide	160 - 300	0.02 - 0.07	0.05 - 0.13	0.10 - 0.15	0.15 - 0.23
	Low Carbon Steel 1010, 1020, 1025, 1522, 1144, etc.	85 - 275	Carbide	145 - 280	0.02 - 0.05	0.05 - 0.10	0.07 - 0.13	0.13 - 0.20
	Medium Carbon Steel 1030, 1040, 1050, 1527, 1140, 1151, etc.	125 - 325	Carbide	145 - 250	0.02 - 0.05	0.05 - 0.10	0.07 - 0.13	0.13 - 0.20
	Alloy Steel 4140, 5140, 8640, etc.	125 - 375	Carbide	120 - 210	0.02 - 0.05	0.05 - 0.10	0.07 - 0.13	0.13 - 0.20
	High Strength Alloy 4340, 4330V, 300M, etc.	225 - 400	Carbide	100 - 180	0.02 - 0.05	0.05 - 0.10	0.07 - 0.13	0.13 - 0.20
	Structural Steel A36, A285, A516, etc.	100 - 350	Carbide	145 - 280	0.02 - 0.05	0.05 - 0.10	0.07 - 0.13	0.13 - 0.20
	Tool Steel H-13, H-21, A-4, O-2, S-3, etc.	150 - 250	Carbide	100 - 180	0.02 - 0.05	0.05 - 0.07	0.07 - 0.10	0.10 - 0.15
S	High Temp Alloy Hastelloy B, Inconel 600, etc.	140 - 310	Carbide	30 - 70	0.02 - 0.05	0.05 - 0.07	0.07 - 0.13	0.10 - 0.15
	Titanium Alloy	140 - 310	Carbide	40 - 90	0.02 - 0.05	0.05 - 0.07	0.07 - 0.13	0.10 - 0.15
	Aerospace Alloy S82	185 - 350	Carbide	40 - 90	0.02 - 0.05	0.05 - 0.07	0.07 - 0.13	0.10 - 0.15
M	Stainless Steel 400 Series 416, 420, etc.	185 - 350	Carbide	90 - 160	0.02 - 0.05	0.05 - 0.10	0.07 - 0.10	0.10 - 0.15
	Stainless Steel 300 Series 304, 316, 17-4PH, etc.	135 - 275	Carbide	90 - 160	0.02 - 0.05	0.05 - 0.10	0.07 - 0.10	0.10 - 0.15
	Super Duplex Stainless Steel	135 - 275	Carbide	90 - 160	0.02 - 0.05	0.05 - 0.10	0.07 - 0.10	0.10 - 0.15
H	Wear Plate	400 - 600	Carbide	30 - 60	0.02 - 0.05	0.05 - 0.07	0.07 - 0.10	0.10 - 0.15
	Hardened Steel	300 - 500	Carbide	40 - 80	0.02 - 0.05	0.05 - 0.07	0.07 - 0.10	0.10 - 0.15
K	SG / Nodular Cast Iron	120 - 320	Carbide	145 - 260	0.02 - 0.05	0.05 - 0.10	0.07 - 0.13	0.13 - 0.20
	Grey / White Iron	180 - 320	Carbide	180 - 306	0.02 - 0.05	0.05 - 0.10	0.07 - 0.13	0.13 - 0.20
N	Cast Aluminum	30 - 180	Carbide	260 - 306	0.02 - 0.05	0.05 - 0.10	0.07 - 0.13	0.13 - 0.20
	Wrought Aluminum	30 - 180	Carbide	205 - 305	0.02 - 0.07	0.05 - 0.13	0.10 - 0.15	0.15 - 0.23
	Aluminum Bronze	100 - 250	Carbide	145 - 280	0.02 - 0.05	0.05 - 0.10	0.10 - 0.13	0.13 - 0.20
	Brass	100	Carbide	205 - 305	0.02 - 0.05	0.05 - 0.10	0.07 - 0.13	0.13 - 0.20
	Copper	60	Carbide	100 - 180	0.02 - 0.05	0.05 - 0.07	0.07 - 0.10	0.10 - 0.13

\*Not to exceed max recommended RPM for boring head

## Deep Hole Boring Speed Adjustment

▲ For Dynamic Boring Tool Length			
Boring Type	7xD	8xD	9xD
Finishing	0.70	0.50	0.30

## Recommended Speed Example

If the recommended speed for a finish boring assembly under 5xD is 260 M/min, then the speed for an 8xD finish boring assembly in the same application would be 260 M/min. (260 M/min x 0.50 = 130 M/min)

5xD = 260 M/min

8xD = 130 M/min

**IMPORTANT:** Max spindle speed refers to maximum possible speed for individual boring head and is not a recommended parameter. Refer to page B20: 62 for recommended application specific parameters. Factory technical assistance is available for your specific applications through our Application Engineering department.  
ext: 7611 | email: appeng@alliedmachine.com

## ⚠ WARNING Tool failure can cause serious injury. To prevent:

- Do not exceed recommended 9xD length to diameter ratio or exceed 4 total components (including shank)
- Refer to example on page B20: 60 for calculating length to diameter ratio

Factory technical assistance is available for your specific applications through our Application Engineering department.







# S.C.A.M.I.®

## ROLLER BURNISHING

When your mirror finish still isn't shiny enough, follow your Criterion® boring tool with a S.C.A.M.I. roller burnisher. Contact your local Allied Machine & Engineering representative for more details.





SECTION

---

C

---

Reaming

# ALVAN® Reamers

Replaceable Head Style | Monobloc Style | Cutting Ring Style



## Every Option for Every Application

Allied Machine & Engineering is pleased to offer ALVAN® Reamers through an exclusive supply agreement with S.C.A.M.I.® s.n.c., an Italian manufacturer that provides high quality cutting tools.

In addition to producing close tolerances and dimensional accuracy of machined holes, these high performance reaming products provide lower costs per hole through high penetration rates, making them the ideal choice for finishing holes in a production environment. It can also prove to be an alternative to finish boring by providing more consistent hole sizes and lower cycle times.

Excellent hole tolerances	Improves hole quality and surface finish	Expandable design accommodates for wear
---------------------------	--	---

## Applicable Industries

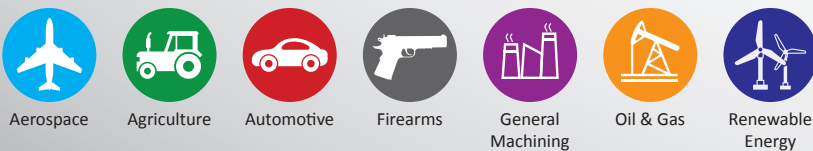

Your safety and the safety of others is very important. This catalog contains important safety messages. Always read and follow all safety precautions.



This triangle is a safety hazard symbol. It alerts you to potential safety hazards that can cause tool failure and serious injury.

When you see this symbol in the catalog, look for a related safety message that may be near this triangle or referred to in the nearby text.

There are safety signal words also used in the catalog. Safety messages follow these words.

### **WARNING**

**WARNING** (shown above) means that failure to follow the precautions in this message could result in tool failure and serious injury.

**NOTICE** means that failure to follow the precautions in this message could result in damage to the tool or machine but not result in personal injury.

**NOTE** and **IMPORTANT** are also used. These are important that you read and follow but are not safety-related.

Visit [www.alliedmachine.com](http://www.alliedmachine.com) for the most up-to-date information and procedures.

**Reference Icons**

The following icons will appear throughout the catalog to help you navigate between products.



**Setup / Assembly Information**

Detailed instructions and information regarding the corresponding part(s)

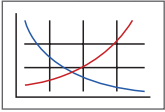

**Recommended Cutting Data**

Speed and feed recommendations for optimum and safe reaming

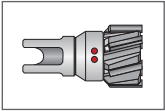

**Replaceable Reamer Heads**

Refers to the reamer head options that connect to the reamer mandrels

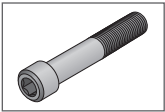

**Replaceable Reamer Screws**

Refers to the reamer head screw options that connect the head to the reamer mandrels

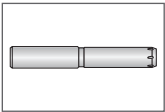

**Replaceable Reamer Mandrels**

Refers to the reamer mandrel options that connect with the head and screw



**Cutting Rings**

Refers to the available cutting ring options



**Coolant Through Option**

Indicates that the product is coolant through



**Allied Machine & Engineering offers ALVAN® Reamers through an exclusive supply agreement with S.C.A.M.I.® s.n.c.**

S.C.A.M.I. is an Italian manufacturer that has been producing high quality cutting tools for over 40 years. In addition to producing close tolerances and dimensional accuracy of machined holes, this high performance reaming product provides a lower cost-per-hole through its high penetration rates. This makes the ALVAN Reamer product line an ideal choice for finishing holes in a production environment. It can also prove to be an alternative to finish boring by providing more consistent hole sizes and lower cycle times.

Visit [www.alliedmachine.com](http://www.alliedmachine.com) for additional information about all Allied Machine products, or contact our Application Engineering department for technical assistance.

**Introduction Information**

Case Study Example . . . . . 2  
 Reconditioning Service . . . . . 3  
 Reaming Overview and Selection . . . . . 4 - 7  
 Lead-ins, Coatings, Materials, and Dimples . . . . . 8 - 9

**Replaceable Head Reamers**

Product Overview . . . . . 10  
 Product Nomenclature . . . . . 11  
     Heads . . . . . 12 - 13  
     Screws . . . . . 14 - 15  
     Mandrels . . . . . 16 - 19

**Monobloc Reamers**

Product Overview . . . . . 20  
 Product Nomenclature . . . . . 21  
 Monobloc Reamers . . . . . 22 - 29

**Ring Style Reamers**

Product Overview . . . . . 30  
 Product Nomenclature . . . . . 31  
     Cutting Rings . . . . . 32 - 33  
     Mandrels . . . . . 34 - 53

**Shanks**

Radial Adjusting Shanks . . . . . 54 - 59  
 Radial Adjusting Adapters . . . . . 60 - 61

**Recommended Cutting Data**

Imperial (inch)	[	Replaceable Head Style . . . . . 62 - 63
		Monobloc Style . . . . . 64 - 65
		Cutting Ring Style . . . . . 66 - 67
Metric (mm)	[	Replaceable Head Style . . . . . 68 - 69
		Monobloc Style . . . . . 70 - 71
		Cutting Ring Style . . . . . 72 - 73

**Technical Information**

Set-up: Replaceable Head Style . . . . . 74  
 Set-up: Monobloc Style . . . . . 75  
 Set-up: Cutting Ring Style . . . . . 76  
 Diameter Measurement . . . . . 77  
 TIR Measurement and Adjustment . . . . . 78 - 79  
 Troubleshooting Guide . . . . . 80

Case Study Example

# CASE STUDY



The **PROOF** is in the **NUMBERS**

**Project Profile:** Grey Cast Iron Hydraulic Transmission Component  
**Tooling Solution:** ALVAN® Reamer - Monobloc Style

**The Problem:**

Previously, the customer was using a competitor boring tool running at the following parameters:

- 3802 RPM
- 500 SFM
- 0.003 IPR
- 11.41 IPM

With 2 passes, the tool made a 0.5023” diameter hole to a 1.20” depth.

- Cycle time = 12.6 seconds
- Tool life = 75 parts

Seeking to streamline the production process, the customer needed to increase tool life and lower the cost of production.

**The Solution:**

Allied Machine recommended the ALVAN® monobloc style reamer.

- **Reamer** = 92440 series carbide, uncoated, V lead

The tool ran at the following parameters:

- 2200 RPM
- 289 SFM
- 0.019 IPR
- 41.80 IPM

The tool achieved the desired diameter and depth, and the results achieved the customer’s goals.

- Cycle time = 1.7 seconds
- Tool life = 3,176 parts

**The Advantages:**

The customer was able to lower the cost of production and increase the tool life.

- Reduced cycle time *from 12.6 seconds to 1.7 seconds*
- Increased tool life *from 75 parts to an incredible 3,176 parts*
- Total cost savings = **\$2,407 (or 52%)**



**Tool Life: Competitor Boring**  
(number of parts = 75)



**Tool Life: ALVAN® Monobloc Style Reamer**  
(number of parts = 3,176)

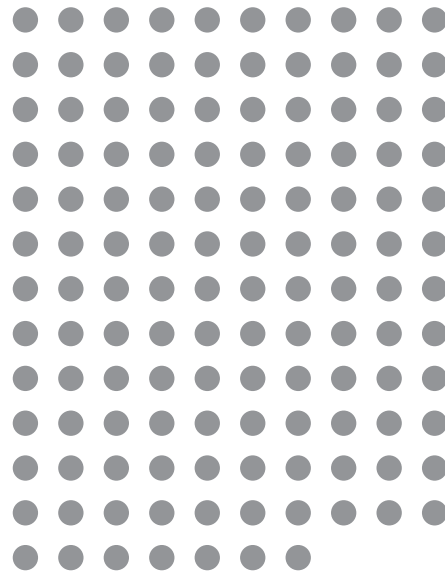



Overall **SAVINGS** of **52%**



A DRILLING  
B BORING  
C REAMING  
D BURINISHING  
E THREADING  
X SPECIALS

## Reconditioning Service

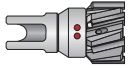
All ALVAN Reamers can be reconditioned to help reduce your overall tooling costs. This service is provided through Allied Machine & Engineering by utilizing the expertise of S.C.A.M.I. We will process the tools with a 25-35 work day lead time, depending on the style, the date we receive the tools, and the purchase order.

Reamer Style	Lead Time (work days)	Part No.	Reconditioned Part No.
 Replaceable Head	25	I7405-SVG-10000	RI7405SVG10000
 Monobloc	35	AL3620I04853	AL3620I04853 <b>RP1</b>
 Cutting Ring	35	AL2TIAI05820	AL2TIAI05820 <b>RP1</b>



Parts to be Reconditioned  
(packaged safely)



Purchase Order



Allied Machine & Engineering  
Attn: Regrind Department  
120 Deeds Drive  
Dover, OH 44622  
United States

Reaming Overview

A  
DRILLING  
B  
BORING  
C  
REAMING  
D  
BURNISHING  
E  
THREADING  
X  
SPECIALS

# REAMER STYLES



**Replaceable Head**  
Pages C: 10 - 19

- Diameter range: 11.80mm - 60.60mm
- Heads are available as fixed or expanding for improved productivity
- Straight or left hand helical flutes provide solutions for both through and blind holes
- Cylindrical or modular shanks improve concentricity



**Monobloc**  
Pages C: 20 - 29

- Diameter range: 5.80mm - 32.60mm
- Available with central or radial through coolant
- Can be used for through or blind holes
- Cylindrical shanks improve concentricity
- Expandable to accommodate for wear



**Cutting Ring**  
Pages C: 30 - 53

- Diameter range: 17.60mm - 200.60mm
- The cutting edges are positioned asymmetrically to assure the best roundness of the hole
- Holes with tight tolerances can be accommodated, and the expansion ensures a perfect holding of the reaming diameter

**General Reaming Notes**

- If the depth is over 9xD, use a short length reamer to pilot the hole. Then finish with the longer length ⚠.
- For blind hole applications, always use central coolant. If in doubt, contact Allied's Application Engineering department.
- More stock allowance can be taken in softer materials. Less stock allowance should be taken in harder materials.
- A common practice to rapid out of the cut on through holes and to breakout only 2mm past the reaming depth.

**IMPORTANT:** Always use molykote (anti-seize applicant) on the conical seat and the threads on the central screw for assembly.

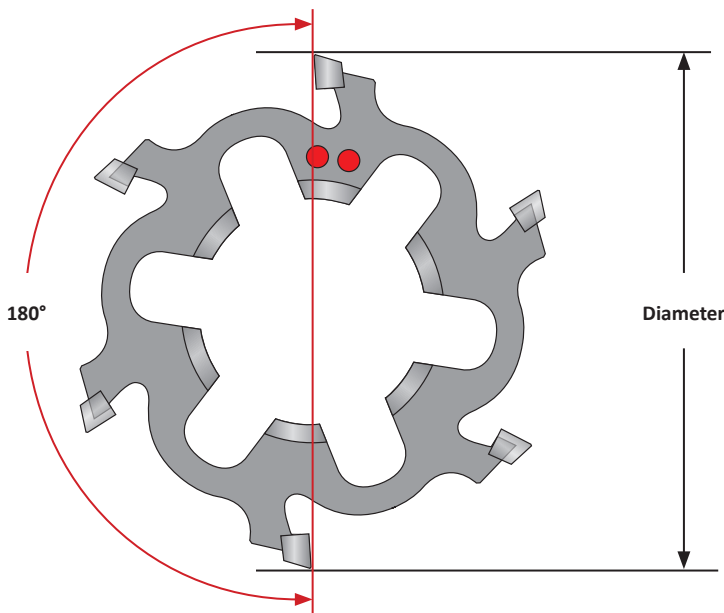
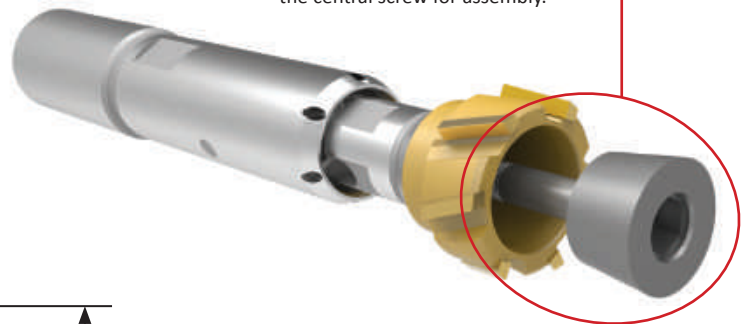

**NOTE:** The position of the dimples indicates which 2 cutting teeth are 180° opposed. Diameter measurements should be taken from these 2 cutting teeth.

**⚠ WARNING** Tool failure can cause serious injury. To prevent:



- When using holders without support bushing, use a shorter reamer to establish the initial hole diameter that is a minimum of 2 diameters deep.
- Do not rotate reamers more than 50 RPM unless it is engaged with the workpiece or fixture.

Factory technical assistance is available for your specific applications through our Application Engineering Team.

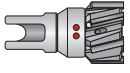
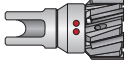

## Quick Selection Guide

### Breakdown by Diameter

Reamer Style	0.2283" 5.799mm	0.4656" 11.800mm	0.6929" 17.600mm	1.1024" 28.000mm	1.2638" 32.100mm	1.7717" 45.000mm	2.3858" 60.600mm	3.7402" 95.000mm	5.1181" 130.000mm	6.4961" 165.000mm	7.8975" 200.600mm
 Replaceable Head (Fixed)		[Red bar]									
 Replaceable Head (Expandable)		[Red bar]									
 Monobloc	[Red bar]										
 Cutting Ring			[Red bar]								

### Breakdown by Features

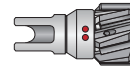
Reamer Style	Capable Tolerance	Fastest Set-up	Replaceable Cutting Head	Expandable to Adjust for Wear	Recondition Available	Cylindrical Shanks	Modular Shanks	Through Coolant Options
 Replaceable Head (fixed)	H7	<input checked="" type="checkbox"/>	<input checked="" type="checkbox"/>		<input checked="" type="checkbox"/>	<input checked="" type="checkbox"/>	<input checked="" type="checkbox"/>	<input checked="" type="checkbox"/>
 Replaceable Head (expandable)	H6		<input checked="" type="checkbox"/>	<input checked="" type="checkbox"/>	<input checked="" type="checkbox"/>	<input checked="" type="checkbox"/>	<input checked="" type="checkbox"/>	<input checked="" type="checkbox"/>
 Monobloc	H6			<input checked="" type="checkbox"/>	<input checked="" type="checkbox"/>	<input checked="" type="checkbox"/>		<input checked="" type="checkbox"/>
 Cutting Ring	H6		<input checked="" type="checkbox"/>	<input checked="" type="checkbox"/>	<input checked="" type="checkbox"/>	<input checked="" type="checkbox"/>	<input checked="" type="checkbox"/>	<input checked="" type="checkbox"/>

For more details on how to select a reamer, see the following pages.

## How the Reamer Works

### How the Reamer Works

- The cut is made in the lead-in zone (3), and the chip is made on the cutting face (1). The chip is removed by coolant.
- The lead-in (3) is defined depending on the application, the workpiece material, and the stock allowance.
- The radial land (2) is important for holding a good alignment, improving the surface roughness, and giving an effect similar to burnishing. The dimension of the radial land depends on the diameter.
- The radial land (2) is manufactured to be tapered on the rear.
- Fixed reamers are manufactured at the exact tapered value. Expandable reamers must be adjusted to the exact diameter. Both are already supplied at the nominal diameter by the manufacturer.
- The undercut of the cutting edge (5) avoids retract marks on the piece when the reamer is retracted from the cut.
- The front of the cutting edge (6) does not cut; if this feature is needed, a frontal lead must be supplied.

### When to Apply a Reamer

- When the requested tolerance on diameter is IT8 or less
- When the requested finish is 63 µin (1.6 µmm) Ra or greater
- When the critical geometry characteristics of the hole are the roundness and straightness
- When parts are being mass produced
- When the parts are large and expensive

### Elements of the Cutting Tooth

- (1) Cutting Face
- (2) Radial Land
- (3) Lead-in / Primary Face / Secondary Face
- (4) Rear Face
- (5) Undercut of Cutting Edge
- (6) Front of Cutting Edge

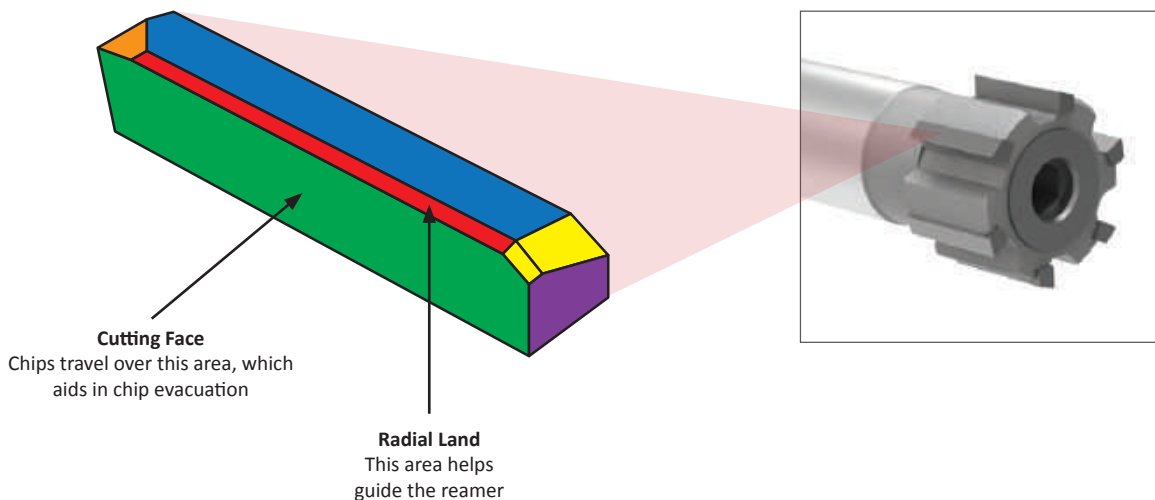

## Reamer Recommendation Guide











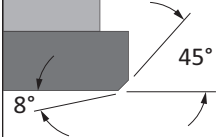

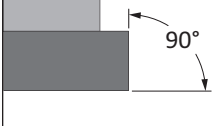

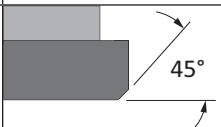
ISO	Material	Hardness (BHN)	Through Hole				Blind Hole			
			Uninterrupted		Interrupted		Uninterrupted		Interrupted	
			Lead	Substrate & Coating	Lead	Substrate & Coating	Lead	Substrate & Coating	Lead	Substrate & Coating
P	Free Machining Steel 1118, 1215, 12L14, etc.	Below 150	N or E	Cermet Uncoated	E	Cermet Uncoated	J	Cermet Uncoated	V	Cermet Uncoated
		150 Above								
	Low Carbon Steel 1010, 1020, 1522, 1144, etc.	Below 250	N or E	Cermet Uncoated	E	Cermet Uncoated	J	Cermet Uncoated	V	Cermet Uncoated
	Medium Carbon Steel 1030, 1040, 1050, 1140, 1151, etc.	Below 300	N or E	Cermet Uncoated	E	Cermet Uncoated	X	Cermet Uncoated	V	Cermet Uncoated
	Alloy Steel 4140, 5140, 8640, etc.	Below 350	G or M	Cermet Uncoated	M	Cermet Uncoated	X	Cermet Uncoated	G	Cermet Uncoated
	High Strength Alloy 4340, 4330V, 300M, etc.	240 - 450	G or M*	Carbide Alcrona	M	Carbide Alcrona	X*	Carbide Alcrona	G*	Carbide Alcrona
	Structural Steel	–	E	Cermet	M	Carbide TiAlN	X	Cermet	G	Carbide TiAlN
Tool Steel	–	M*	Carbide TiAlN	M*	Carbide TiAlN	X*	Carbide TiAlN	G*	Carbide TiAlN	
S	High Temp Alloy	–	G*	Carbide TiAlN	G*	Carbide TiAlN	X*	Carbide TiAlN	G*	Carbide TiAlN
	Titanium Alloys	–	T	Carbide TiAlN	T	Carbide TiAlN	T	Carbide TiAlN	T	Carbide TiAlN
M	Austenitic Stainless Steel 304, 316, etc.	–	E	Carbide Alcrona	E	Carbide Alcrona	X	Carbide Alcrona	G*	Carbide Alcrona
	Ferritic Martensitic Stainless Steel 416, 420, 17-4PH, 15-5PH, etc.	–	N or E	Cermet or Carbide Alcrona	E	Cermet or Carbide Alcrona	X	Cermet or Carbide Alcrona	G	Cermet or Carbide Alcrona
K	Ductile Cast Iron Spheroidal - GS500	Below 130	V	Carbide Alcrona	V	Carbide Alcrona	J	Carbide Alcrona	V	Carbide Alcrona
		130 Above		Cermet Alcrona		Cermet Alcrona		Cermet Alcrona		
	Grey Cast Iron GC15 - GC20 - GC25 - GC35	–	V	Carbide TiAlN	V	Carbide TiAlN	J	Carbide TiAlN	V	Carbide TiAlN
N	Bronze Brass Copper	Below 300	E	Carbide Uncoated	E	Carbide Uncoated	X	Carbide Uncoated	G	Carbide Uncoated
	Aluminum	Below 7% Si	V	Carbide Uncoated	V	Carbide Uncoated	V	Carbide Uncoated	G	Carbide Uncoated
		Above 7% Si	G	PCD Uncoated	G	PCD Uncoated	G	PCD Uncoated		PCD Uncoated

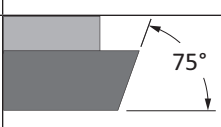
\*Contact our Application Engineering department for special geometries to improve tool life.

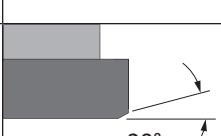
A DRILLING  
B BORING  
C REAMING  
D BURNISHING  
E THREADING  
X SPECIALS

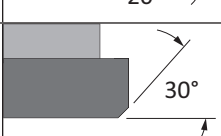

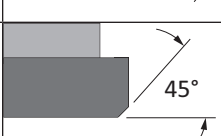

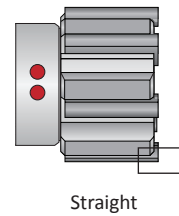

## Lead-in Angle Information

### Straight Flute

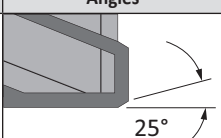
Lead-in	Angles	Chip Evacuation	Description
<b>A</b>			Lead-in can be used to improve finish.
<b>F or Y</b>			Can be used for stock removal at the bottom of the hole. Reduce the feed by 40% of the values on the recommended cutting data pages. - <b>F lead</b> = no chipbreaker - <b>Y lead</b> = chipbreaker
<b>G or X</b>			Standard and suitable for most materials. - <b>G lead</b> = no chipbreaker - <b>X lead</b> = chipbreaker
<b>L or W</b>			May provide improved straightness. Reduce the feed by 40% of the values on the recommended cutting data pages. - <b>L lead</b> = no chipbreaker - <b>W lead</b> = chipbreaker
<b>N</b>			Ideal for through holes. It is possible to increase the feed up to 100% of the values on the recommended cutting data pages.
<b>T</b>			Suitable for titanium based alloys.
<b>V or J</b>			Suitable for most materials and increases tool life - <b>V lead</b> = no chipbreaker - <b>J lead</b> = chipbreaker

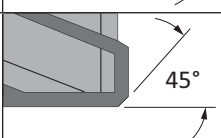

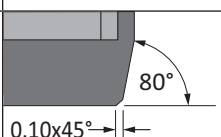
### Helical Flute (Left Hand) - Through Hole Applications Only

Lead-in	Angles	Chip Evacuation	Description
<b>E</b>			Standard and suitable for most materials. <b>NOTE:</b> Through hole applications only.
<b>M</b>			May provide better penetration rates in steels over 200 BHN. <b>NOTE:</b> Through hole applications only.
<b>K</b>			Excellent at breaking small chips that are easy to evacuate in blind hole applications. Requires 50% increased feed rate which will result in reduced tool life when compared to other leads.

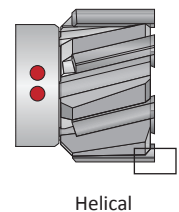

## Coatings, Cutting Materials, and Dimple Indicators

### Coating Information

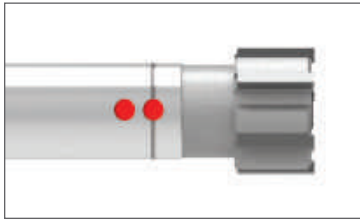

**Uncoated**

Ideal for non-ferrous applications

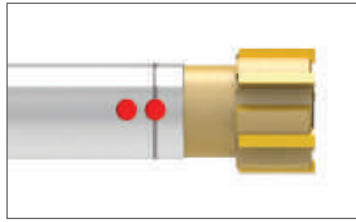

**TiN (N)**

Ideal for general purpose applications

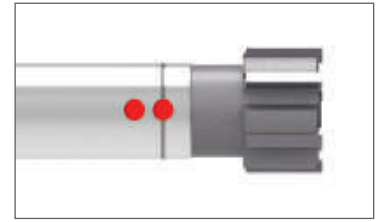

**TiAlN (A)**

Provides higher heat resistance to improve tool life

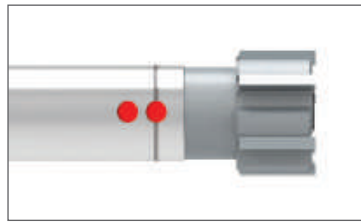

**TiCN (C)**

Provides improved surface finish

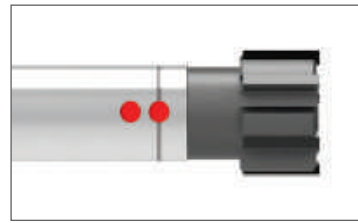







**Alcrona (K)**

Provides excellent wear resistance and can help increase cutting speeds

### Cutting Material Information

Material	Indicator	Details
Carbide	K	A fine-grain carbide suitable for all conventional reaming applications. Recommended where rigidity is not excellent and speeds must be reduced.
Cermet	S	Cermet provides high wear resistance and is recommended for abrasive and increased speed applications. Not recommended for poor rigidity or interrupted cuts.

### Dimple Indicators

Material	Indicator	Replaceable Head Style	Monobloc Style	Cutting Ring Style
Carbide	Two Dimples			
Cermet	Two Dimples with Line			

**NOTE:** The dimple location indicates which 2 cutting teeth are 180° opposed

## Replaceable Head Reamers

### Product Overview

A DRILLING  
B BORING  
C REAMING  
D BURNISHING  
E THREADING  
X SPECIALS

**Fixed Heads**

- Non-expanding diameter
- Locking screw is straight (no taper)
- Allows for on-machine replacement
- Capable of H7 tolerance on diameter
- Available in straight and left hand helical flutes
- Available for recondition

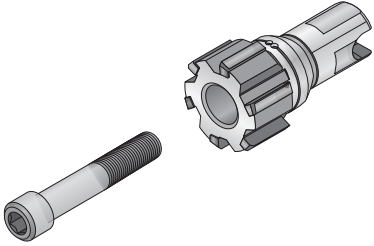

**Expandable Heads**

- Expandable diameter (1% of nominal diameter) to accommodate for wear
- Conical locking screw
- Requires set-up for diameter
- Capable of tight diameter tolerance ( $\pm 0.0002''$  (0.005mm))
- Available in straight and left hand helical flutes
- Available for recondition

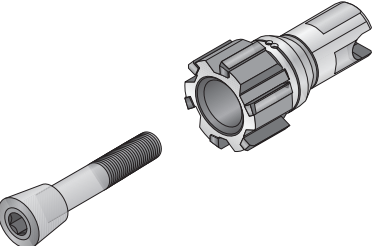

**Mandrels**

- Available in short, standard, and long lengths
- Reamer head design allows multiple diameters to be used within the same mandrel, **which reduces inventory requirements**
- The same mandrel can use both fixed and expandable heads
- Coolant options are offered for both through and blind hole scenarios

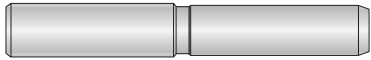

Uncoated



TiN Coated



TiAlN Coated



TiCN Coated



Alcrona Coated

**Mandrel Shanks Available:**

- Cylindrical
- Modular Connection

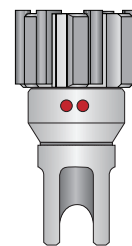

Straight Flute

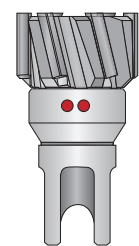

Left Hand Helical Flute



Short Length

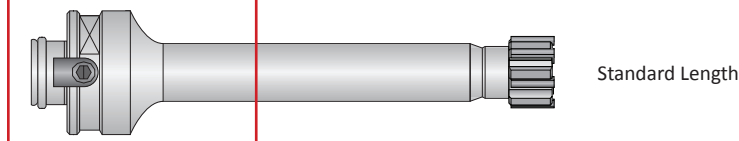

Standard Length



Long Length

Type of Head	Coated/Uncoated	Lead Time in Work Days (based on number of pieces)		
		Up to 5	6 - 19	20+
Fixed	Coated	15	25	25
	Uncoated	10	20	20
Expandable	Coated	20	25	30
	Uncoated	15	20	25

## Product Nomenclature

### Replaceable Head Style Reamer Heads

<b>I</b>	<b>77</b>	<b>00</b>	-	<b>K</b>	<b>N</b>	<b>G</b>	-	<b>18000</b>
1	2	3		4	5	6		7

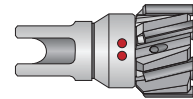

**NOTE:** If tool is reconditioned, put an "R" at the beginning of the item number

<b>1. Shank Measure</b> Blank = Metric I = Inch	<b>2. Flute Style</b> 74 = Straight 77 = Left hand helical	<b>3. Head Style</b> 00 = Fixed head 05 = Expandable head	<b>4. Substrate</b> K = Carbide S = Cermet	<b>5. Coating</b> L = Uncoated carbide V = Uncoated cermet N = TiN C = TiCN A = TiAlN K = Alcrona
<b>6. Lead-in</b> E, M, K = Left hand helical flute A, F, G, L, N, T, V = Straight flute J, W, X, Y = Straight flute with chipbreaker	<b>7. Diameter</b> XX.XXX = Metric X.XXXX = Inch			

#### Reference Key

Symbol	Attribute
$D_1$	Reamer head diameter
$D_2$	Shank diameter
$L_1$	Overall length
$L_2$	Length of cut
$H$	Hex key (listed with screws)

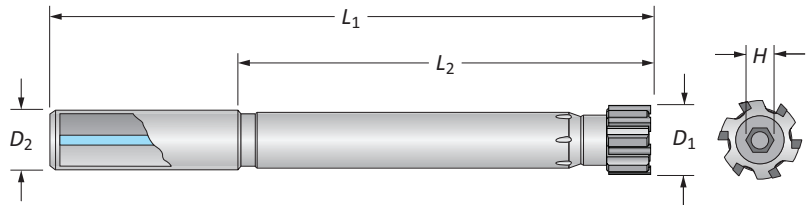

#### Building Your Complete Tool

You will need all three pieces to complete your replaceable head reamer assembly. The item numbers for the screws and the mandrels are listed on their respective pages. However, there is a guide on the pages where the heads are located. You must follow the guide to build the item number for the reamer head that you need.

The complete mandrel item numbers are listed on their respective pages. You do not need to build the mandrel numbers.



**1**

Select Your Head

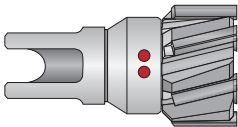

**2**

Select Your Screw



**3**

Select Your Mandrel

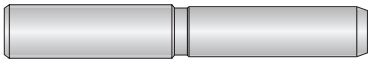

## Replaceable Heads

Fixed

### Build Your Part No.

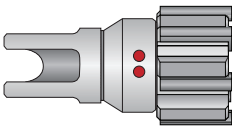
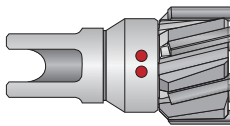
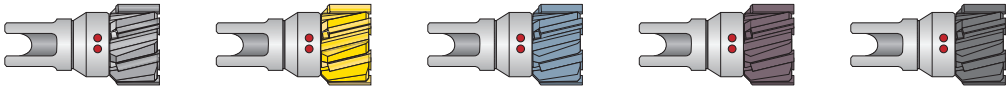
<b>1</b> Series	7400 Series	7700 Series																																																																																				
<b>2</b> Flute Style  Your flute style is based on your series selection (above)	Straight Flute 	Helical Flute (Left Hand) 																																																																																				
<b>3</b> Carbide Grade and Coating Codes  These are the combinations of grades and coatings you can choose from																																																																																						
	<table border="1" style="width: 100%; text-align: center;"> <thead> <tr> <th></th> <th>Uncoated</th> <th>TiN</th> <th>TiCN</th> <th>TiAlN</th> <th>Alcrona</th> </tr> </thead> <tbody> <tr> <th>Carbide</th> <td>KL</td> <td>KN</td> <td>KC</td> <td>KA</td> <td>KK</td> </tr> <tr> <th>Cermet</th> <td>SV</td> <td>SN</td> <td>SC</td> <td>SA</td> <td>SK</td> </tr> </tbody> </table>			Uncoated	TiN	TiCN	TiAlN	Alcrona	Carbide	KL	KN	KC	KA	KK	Cermet	SV	SN	SC	SA	SK																																																																		
	Uncoated	TiN	TiCN	TiAlN	Alcrona																																																																																	
Carbide	KL	KN	KC	KA	KK																																																																																	
Cermet	SV	SN	SC	SA	SK																																																																																	
<b>4</b> Lead-in Recommendations	<table border="1" style="width: 100%; text-align: center;"> <thead> <tr> <th></th> <th>T</th> <th>F</th> <th>N</th> <th>G</th> <th>L</th> <th>A</th> <th>V</th> </tr> </thead> <tbody> <tr> <th>P</th> <td></td> <td></td> <td>●</td> <td>●</td> <td></td> <td>◐</td> <td>○</td> </tr> <tr> <th>S</th> <td>●</td> <td></td> <td></td> <td>◐</td> <td></td> <td></td> <td></td> </tr> <tr> <th>M</th> <td></td> <td></td> <td></td> <td>●</td> <td>◐</td> <td></td> <td></td> </tr> <tr> <th>H</th> <td></td> <td></td> <td>◐</td> <td>●</td> <td></td> <td></td> <td></td> </tr> <tr> <th>K</th> <td>○</td> <td></td> <td></td> <td>●</td> <td></td> <td></td> <td>◐</td> </tr> <tr> <th>N</th> <td></td> <td></td> <td></td> <td>●</td> <td></td> <td>●</td> <td>◐</td> </tr> </tbody> </table>		T	F	N	G	L	A	V	P			●	●		◐	○	S	●			◐				M				●	◐			H			◐	●				K	○			●			◐	N				●		●	◐	<table border="1" style="width: 100%; text-align: center;"> <thead> <tr> <th></th> <th>E</th> <th>M</th> <th>K</th> </tr> </thead> <tbody> <tr> <th>P</th> <td>●</td> <td></td> <td></td> </tr> <tr> <th>S</th> <td>●</td> <td>◐</td> <td></td> </tr> <tr> <th>M</th> <td>●</td> <td></td> <td></td> </tr> <tr> <th>H</th> <td>◐</td> <td>●</td> <td></td> </tr> <tr> <th>K</th> <td>◐</td> <td>●</td> <td></td> </tr> <tr> <th>N</th> <td>●</td> <td>◐</td> <td></td> </tr> </tbody> </table>		E	M	K	P	●			S	●	◐		M	●			H	◐	●		K	◐	●		N	●	◐	
	T	F	N	G	L	A	V																																																																															
P			●	●		◐	○																																																																															
S	●			◐																																																																																		
M				●	◐																																																																																	
H			◐	●																																																																																		
K	○			●			◐																																																																															
N				●		●	◐																																																																															
	E	M	K																																																																																			
P	●																																																																																					
S	●	◐																																																																																				
M	●																																																																																					
H	◐	●																																																																																				
K	◐	●																																																																																				
N	●	◐																																																																																				
<b>5</b> Diameter (H7 Tolerance)  For the diameter portion of the item number, refer to the following tables:	<table border="1" style="width: 100%; text-align: center;"> <thead> <tr> <th colspan="2">Imperial (in)</th> <th colspan="2">Metric (mm)</th> </tr> <tr> <th>D<sub>1</sub> Range</th> <th>Tolerance (min/max)</th> <th>D<sub>1</sub> Range</th> <th>Tolerance (min/max)</th> </tr> </thead> <tbody> <tr> <td>0.4656 - 0.7086</td> <td>+0 / +0.0007</td> <td>11.800 - 18.000</td> <td>+0 / +0.018</td> </tr> <tr> <td>0.7087 - 1.1811</td> <td>+0 / +0.0008</td> <td>18.001 - 30.000</td> <td>+0 / +0.021</td> </tr> <tr> <td>1.1812 - 1.9685</td> <td>+0 / +0.0010</td> <td>30.001 - 50.000</td> <td>+0 / +0.025</td> </tr> <tr> <td>1.9686 - 2.3858</td> <td>+0 / +0.0012</td> <td>50.001 - 60.600</td> <td>+0 / +0.030</td> </tr> </tbody> </table>		Imperial (in)		Metric (mm)		D <sub>1</sub> Range	Tolerance (min/max)	D <sub>1</sub> Range	Tolerance (min/max)	0.4656 - 0.7086	+0 / +0.0007	11.800 - 18.000	+0 / +0.018	0.7087 - 1.1811	+0 / +0.0008	18.001 - 30.000	+0 / +0.021	1.1812 - 1.9685	+0 / +0.0010	30.001 - 50.000	+0 / +0.025	1.9686 - 2.3858	+0 / +0.0012	50.001 - 60.600	+0 / +0.030																																																												
Imperial (in)		Metric (mm)																																																																																				
D <sub>1</sub> Range	Tolerance (min/max)	D <sub>1</sub> Range	Tolerance (min/max)																																																																																			
0.4656 - 0.7086	+0 / +0.0007	11.800 - 18.000	+0 / +0.018																																																																																			
0.7087 - 1.1811	+0 / +0.0008	18.001 - 30.000	+0 / +0.021																																																																																			
1.1812 - 1.9685	+0 / +0.0010	30.001 - 50.000	+0 / +0.025																																																																																			
1.9686 - 2.3858	+0 / +0.0012	50.001 - 60.600	+0 / +0.030																																																																																			

● Best ◐ Better ○ Good





#### Ordering Example:

The customer needs the following:

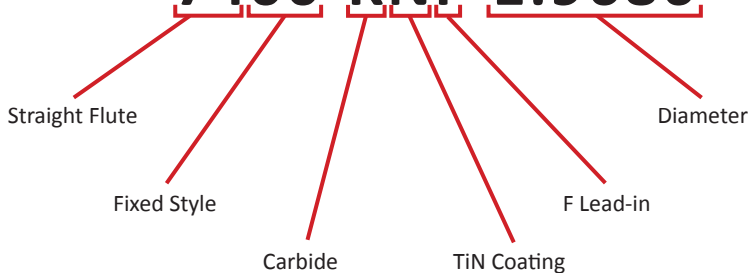
- Straight fluted reamer head
- Fixed style
- Carbide
- TiN coating
- F lead-in
- 1.9686" diameter

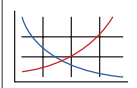
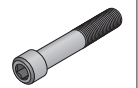
# 7400-KNF-1.9686

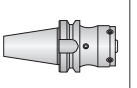

C: 62 - 73 	C: 14 - 15 	C: 16 - 18 	C: 54 - 61 	C: 74 
---	---	---	---	--

Key on C: 1



## Replaceable Heads

Expandable

**Build Your Part No.**

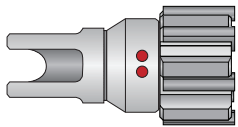
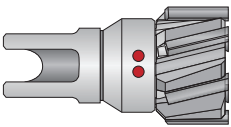
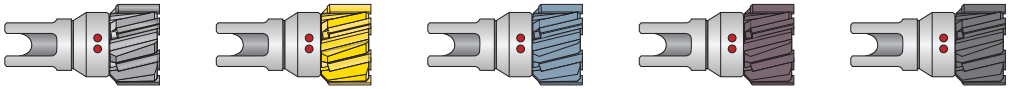
<b>1</b> Series	<b>7405 Series</b>	<b>7705 Series</b>																																																																																				
<b>2</b> Flute Style  Your flute style is based on your series selection (above)	Straight Flute 	Helical Flute (Left Hand) 																																																																																				
<b>3</b> Carbide Grade and Coating Codes  These are the combinations of grades and coatings you can choose from	 <table border="1"> <thead> <tr> <th></th> <th>Uncoated</th> <th>TiN</th> <th>TiCN</th> <th>TiAlN</th> <th>Alcrona</th> </tr> </thead> <tbody> <tr> <th>Carbide</th> <td>KL</td> <td>KN</td> <td>KC</td> <td>KA</td> <td>KK</td> </tr> <tr> <th>Cermet</th> <td>SV</td> <td>SN</td> <td>SC</td> <td>SA</td> <td>SK</td> </tr> </tbody> </table>			Uncoated	TiN	TiCN	TiAlN	Alcrona	Carbide	KL	KN	KC	KA	KK	Cermet	SV	SN	SC	SA	SK																																																																		
	Uncoated	TiN	TiCN	TiAlN	Alcrona																																																																																	
Carbide	KL	KN	KC	KA	KK																																																																																	
Cermet	SV	SN	SC	SA	SK																																																																																	
<b>4</b> Lead-in Recommendations	<table border="1"> <thead> <tr> <th></th> <th>T</th> <th>F</th> <th>N</th> <th>G</th> <th>L</th> <th>A</th> <th>V</th> </tr> </thead> <tbody> <tr> <th>P</th> <td></td> <td></td> <td>●</td> <td>●</td> <td></td> <td>◐</td> <td>○</td> </tr> <tr> <th>S</th> <td>●</td> <td></td> <td></td> <td>◐</td> <td></td> <td></td> <td></td> </tr> <tr> <th>M</th> <td></td> <td></td> <td></td> <td>●</td> <td>◐</td> <td></td> <td></td> </tr> <tr> <th>H</th> <td></td> <td></td> <td>◐</td> <td>●</td> <td></td> <td></td> <td></td> </tr> <tr> <th>K</th> <td>○</td> <td></td> <td></td> <td>●</td> <td></td> <td></td> <td>◐</td> </tr> <tr> <th>N</th> <td></td> <td></td> <td></td> <td>●</td> <td></td> <td>●</td> <td>◐</td> </tr> </tbody> </table>		T	F	N	G	L	A	V	P			●	●		◐	○	S	●			◐				M				●	◐			H			◐	●				K	○			●			◐	N				●		●	◐	<table border="1"> <thead> <tr> <th></th> <th>E</th> <th>M</th> <th>K</th> </tr> </thead> <tbody> <tr> <th>P</th> <td>●</td> <td></td> <td></td> </tr> <tr> <th>S</th> <td>●</td> <td>◐</td> <td></td> </tr> <tr> <th>M</th> <td>●</td> <td></td> <td></td> </tr> <tr> <th>H</th> <td>◐</td> <td>●</td> <td></td> </tr> <tr> <th>K</th> <td>◐</td> <td>●</td> <td></td> </tr> <tr> <th>N</th> <td>●</td> <td>◐</td> <td></td> </tr> </tbody> </table>		E	M	K	P	●			S	●	◐		M	●			H	◐	●		K	◐	●		N	●	◐	
	T	F	N	G	L	A	V																																																																															
P			●	●		◐	○																																																																															
S	●			◐																																																																																		
M				●	◐																																																																																	
H			◐	●																																																																																		
K	○			●			◐																																																																															
N				●		●	◐																																																																															
	E	M	K																																																																																			
P	●																																																																																					
S	●	◐																																																																																				
M	●																																																																																					
H	◐	●																																																																																				
K	◐	●																																																																																				
N	●	◐																																																																																				
<b>5</b> Diameter (H7 Tolerance)  For the diameter portion of the item number, refer to the following tables:	<table border="1"> <thead> <tr> <th colspan="2">Imperial (in)</th> <th colspan="2">Metric (mm)</th> </tr> <tr> <th>D<sub>1</sub> Range</th> <th>Tolerance (min/max)</th> <th>D<sub>1</sub> Range</th> <th>Tolerance (min/max)</th> </tr> </thead> <tbody> <tr> <td>0.4656 - 0.7086</td> <td rowspan="5">-0.0002 / +0.0002</td> <td>11.800 - 18.000</td> <td rowspan="5">-0.005 / +0.005</td> </tr> <tr> <td>0.7087 - 1.1811</td> <td>18.001 - 30.000</td> </tr> <tr> <td>1.1812 - 1.5748</td> <td>30.001 - 40.000</td> </tr> <tr> <td>1.5749 - 1.9685</td> <td>40.001 - 50.000</td> </tr> <tr> <td>1.9686 - 2.3858</td> <td>50.001 - 60.600</td> </tr> </tbody> </table>		Imperial (in)		Metric (mm)		D <sub>1</sub> Range	Tolerance (min/max)	D <sub>1</sub> Range	Tolerance (min/max)	0.4656 - 0.7086	-0.0002 / +0.0002	11.800 - 18.000	-0.005 / +0.005	0.7087 - 1.1811	18.001 - 30.000	1.1812 - 1.5748	30.001 - 40.000	1.5749 - 1.9685	40.001 - 50.000	1.9686 - 2.3858	50.001 - 60.600																																																																
Imperial (in)		Metric (mm)																																																																																				
D <sub>1</sub> Range	Tolerance (min/max)	D <sub>1</sub> Range	Tolerance (min/max)																																																																																			
0.4656 - 0.7086	-0.0002 / +0.0002	11.800 - 18.000	-0.005 / +0.005																																																																																			
0.7087 - 1.1811		18.001 - 30.000																																																																																				
1.1812 - 1.5748		30.001 - 40.000																																																																																				
1.5749 - 1.9685		40.001 - 50.000																																																																																				
1.9686 - 2.3858		50.001 - 60.600																																																																																				

● Best ◐ Better ○ Good

**Ordering Example:**

The customer needs the following:

- Straight fluted reamer head
- Expandable style
- Carbide
- TiN coating
- F lead-in
- 1.9686" diameter

# 7405-KNF-1.9686

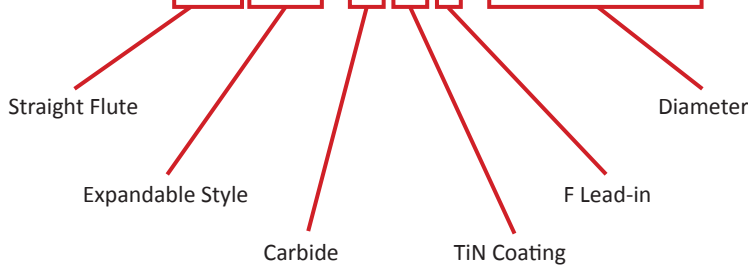

C: 62 - 73    C: 14 - 15    C: 16 - 18    C: 54 - 61    C: 74

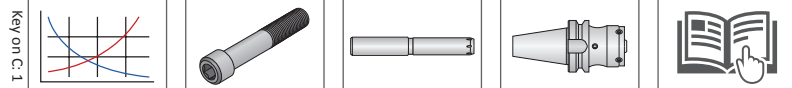

## Replaceable Head Screws

Fixed

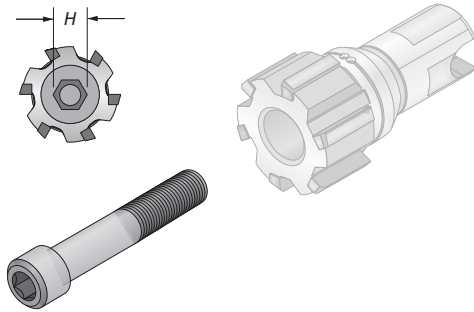

### 7000 Series

$D_1$ Range (inch)	$D_1$ Range (mm)	Part No.	H (mm)
0.4646 - 0.5751	11.800 - 14.609	<b>7000-VI-001</b>	2.5
0.5752 - 0.6932	14.610 - 17.609	<b>7000-VI-002</b>	3
0.6933 - 0.8507	17.610 - 21.609	<b>7000-VI-003</b>	4
0.8508 - 1.0475	21.610 - 26.609	<b>7000-VI-004</b>	5
1.0476 - 1.2838	26.610 - 32.609	<b>7000-VI-005</b>	6
1.2839 - 1.5987	32.610 - 40.609	<b>7000-VI-006</b>	6
1.5988 - 1.9924	40.610 - 50.609	<b>7000-VI-007</b>	8
1.9925 - 2.3858	50.610 - 60.600	<b>7000-VI-008</b>	10

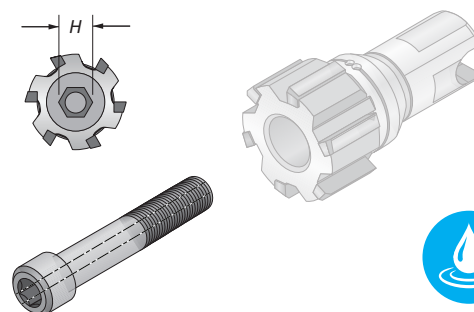

### 7001 Series

$D_1$ Range (inch)	$D_1$ Range (mm)	Part No.	H (mm)
0.4646 - 0.5751	11.800 - 14.609	<b>7001-VI-001</b>	2.5
0.5752 - 0.6932	14.610 - 17.609	<b>7001-VI-002</b>	3
0.6933 - 0.8507	17.610 - 21.609	<b>7001-VI-003</b>	4
0.8508 - 1.0475	21.610 - 26.609	<b>7001-VI-004</b>	5
1.0476 - 1.2838	26.610 - 32.609	<b>7001-VI-005</b>	6
1.2839 - 1.5987	32.610 - 40.609	<b>7001-VI-006</b>	6
1.5988 - 1.9924	40.610 - 50.609	<b>7001-VI-007</b>	8
1.9925 - 2.3858	50.610 - 60.600	<b>7001-VI-008</b>	10

A

DRILLING

B

BORING

C

REAMING

D

BURNISHING

E

THREADING

X

SPECIALS

C: 62 - 73

C: 12 - 13

C: 16 - 18

C: 54 - 61

C: 74

Key on C: 1

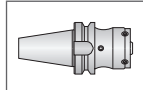
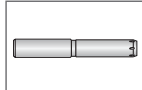
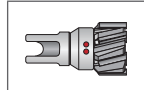
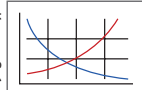



## Replaceable Head Screws

Expandable

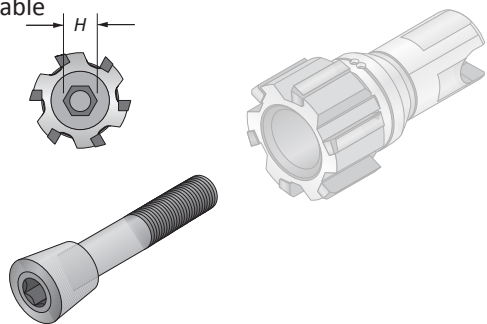

**7000 Series**

D <sub>1</sub> Range (inch)	D <sub>1</sub> Range (mm)	Part No.	H (mm)
0.4646 - 0.4964	11.800 - 12.609	7000-VI-012	3.5
0.4965 - 0.5357	12.610 - 13.609	7000-VI-013	3.5
0.5358 - 0.5751	13.610 - 14.609	7000-VI-014	3.5
0.5752 - 0.6145	14.610 - 15.609	7000-VI-015	4
0.6146 - 0.6538	15.610 - 16.609	7000-VI-016	4
0.6539 - 0.6932	16.610 - 17.609	7000-VI-017	4
0.6933 - 0.7326	17.610 - 18.609	7000-VI-018	5
0.7327 - 0.7719	18.610 - 19.609	7000-VI-019	5
0.7720 - 0.8113	19.610 - 20.609	7000-VI-020	5
0.8114 - 0.8507	20.610 - 21.609	7000-VI-021	5
0.8508 - 0.8901	21.610 - 22.609	7000-VI-022	6
0.8902 - 0.9294	22.610 - 23.609	7000-VI-023	6
0.9295 - 0.9688	23.610 - 24.609	7000-VI-024	6
0.9689 - 1.0082	24.610 - 25.609	7000-VI-025	6
1.0083 - 1.0475	25.610 - 26.609	7000-VI-026	6
1.0476 - 1.0869	26.610 - 27.609	7000-VI-027	8
1.0870 - 1.1263	27.610 - 28.609	7000-VI-028	8
1.1264 - 1.1656	28.610 - 29.609	7000-VI-029	8
1.1657 - 1.2050	29.610 - 30.609	7000-VI-030	8
1.2051 - 1.2444	30.610 - 31.609	7000-VI-031	8
1.2445 - 1.2838	31.610 - 32.609	7000-VI-032	8
1.2839 - 1.3231	32.610 - 33.609	7000-VI-033	8
1.3232 - 1.3625	33.610 - 34.609	7000-VI-034	10
1.3626 - 1.4019	34.610 - 35.609	7000-VI-035	10
1.4020 - 1.4412	35.610 - 36.609	7000-VI-036	10
1.4413 - 1.4806	36.610 - 37.609	7000-VI-037	10
1.4807 - 1.5200	37.610 - 38.609	7000-VI-038	10
1.5201 - 1.5593	38.610 - 39.609	7000-VI-039	10
1.5594 - 1.5987	39.610 - 40.609	7000-VI-040	10
1.5988 - 1.6381	40.610 - 41.609	7000-VI-041	12
1.6382 - 1.6775	41.610 - 42.609	7000-VI-042	12
1.6776 - 1.7168	42.610 - 43.609	7000-VI-043	12
1.7169 - 1.7562	43.610 - 44.609	7000-VI-044	12
1.7563 - 1.7956	44.610 - 45.609	7000-VI-045	12
1.7957 - 1.8349	45.610 - 46.609	7000-VI-046	12
1.8350 - 1.8743	46.610 - 47.609	7000-VI-047	12
1.8744 - 1.9137	47.610 - 48.609	7000-VI-048	12
1.9138 - 1.9530	48.610 - 49.609	7000-VI-049	12
1.9531 - 1.9924	49.610 - 50.609	7000-VI-050	12
1.9925 - 2.0318	50.610 - 51.609	7000-VI-051	12
2.0319 - 2.0712	51.610 - 52.609	7000-VI-052	12
2.0713 - 2.1105	52.610 - 53.609	7000-VI-053	12
2.1106 - 2.1499	53.610 - 54.609	7000-VI-054	12
2.1500 - 2.1893	54.610 - 55.609	7000-VI-055	12
2.1894 - 2.2286	55.610 - 56.609	7000-VI-056	12
2.2287 - 2.2680	56.610 - 57.609	7000-VI-057	12
2.2681 - 2.3074	57.610 - 58.609	7000-VI-058	12
2.3075 - 2.3468	58.610 - 59.609	7000-VI-059	12
2.3469 - 2.3858	59.610 - 60.609	7000-VI-060	12

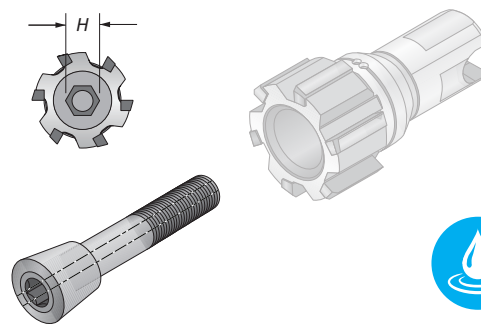

**7001 Series**

D <sub>1</sub> Range (inch)	D <sub>1</sub> Range (mm)	Part No.	H (mm)
0.4646 - 0.4964	11.800 - 12.609	7001-VI-012	3.5
0.4965 - 0.5357	12.610 - 13.609	7001-VI-013	3.5
0.5358 - 0.5751	13.610 - 14.609	7001-VI-014	3.5
0.5752 - 0.6145	14.610 - 15.609	7001-VI-015	4
0.6146 - 0.6538	15.610 - 16.609	7001-VI-016	4
0.6539 - 0.6932	16.610 - 17.609	7001-VI-017	4
0.6933 - 0.7326	17.610 - 18.609	7001-VI-018	5
0.7327 - 0.7719	18.610 - 19.609	7001-VI-019	5
0.7720 - 0.8113	19.610 - 20.609	7001-VI-020	5
0.8114 - 0.8507	20.610 - 21.609	7001-VI-021	5
0.8508 - 0.8901	21.610 - 22.609	7001-VI-022	6
0.8902 - 0.9294	22.610 - 23.609	7001-VI-023	6
0.9295 - 0.9688	23.610 - 24.609	7001-VI-024	6
0.9689 - 1.0082	24.610 - 25.609	7001-VI-025	6
1.0083 - 1.0475	25.610 - 26.609	7001-VI-026	6
1.0476 - 1.0869	26.610 - 27.609	7001-VI-027	8
1.0870 - 1.1263	27.610 - 28.609	7001-VI-028	8
1.1264 - 1.1656	28.610 - 29.609	7001-VI-029	8
1.1657 - 1.2050	29.610 - 30.609	7001-VI-030	8
1.2051 - 1.2444	30.610 - 31.609	7001-VI-031	8
1.2445 - 1.2838	31.610 - 32.609	7001-VI-032	8
1.2839 - 1.3231	32.610 - 33.609	7001-VI-033	8
1.3232 - 1.3625	33.610 - 34.609	7001-VI-034	10
1.3626 - 1.4019	34.610 - 35.609	7001-VI-035	10
1.4020 - 1.4412	35.610 - 36.609	7001-VI-036	10
1.4413 - 1.4806	36.610 - 37.609	7001-VI-037	10
1.4807 - 1.5200	37.610 - 38.609	7001-VI-038	10
1.5201 - 1.5593	38.610 - 39.609	7001-VI-039	10
1.5594 - 1.5987	39.610 - 40.609	7001-VI-040	10
1.5988 - 1.6381	40.610 - 41.609	7001-VI-041	12
1.6382 - 1.6775	41.610 - 42.609	7001-VI-042	12
1.6776 - 1.7168	42.610 - 43.609	7001-VI-043	12
1.7169 - 1.7562	43.610 - 44.609	7001-VI-044	12
1.7563 - 1.7956	44.610 - 45.609	7001-VI-045	12
1.7957 - 1.8349	45.610 - 46.609	7001-VI-046	12
1.8350 - 1.8743	46.610 - 47.609	7001-VI-047	12
1.8744 - 1.9137	47.610 - 48.609	7001-VI-048	12
1.9138 - 1.9530	48.610 - 49.609	7001-VI-049	12
1.9531 - 1.9924	49.610 - 50.609	7001-VI-050	12
1.9925 - 2.0318	50.610 - 51.609	7001-VI-051	12
2.0319 - 2.0712	51.610 - 52.609	7001-VI-052	12
2.0713 - 2.1105	52.610 - 53.609	7001-VI-053	12
2.1106 - 2.1499	53.610 - 54.609	7001-VI-054	12
2.1500 - 2.1893	54.610 - 55.609	7001-VI-055	12
2.1894 - 2.2286	55.610 - 56.609	7001-VI-056	12
2.2287 - 2.2680	56.610 - 57.609	7001-VI-057	12
2.2681 - 2.3074	57.610 - 58.609	7001-VI-058	12
2.3075 - 2.3468	58.610 - 59.609	7001-VI-059	12
2.3469 - 2.3858	59.610 - 60.609	7001-VI-060	12



C: 62 - 73

C: 12 - 13

C: 16 - 18

C: 54 - 61

C: 74

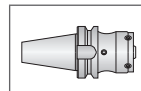
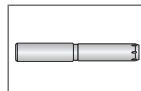
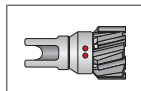
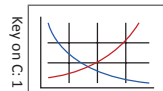

## Replaceable Head Mandrels

Short Length | Cylindrical Shank | Diameter Range: 0.4646" - 2.3858" (11.800mm - 60.600mm)

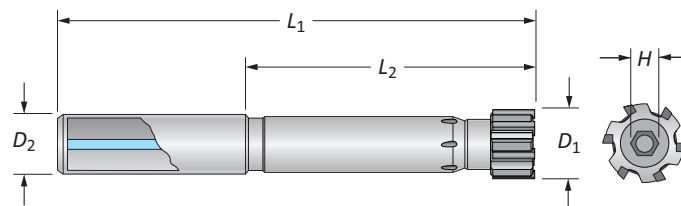
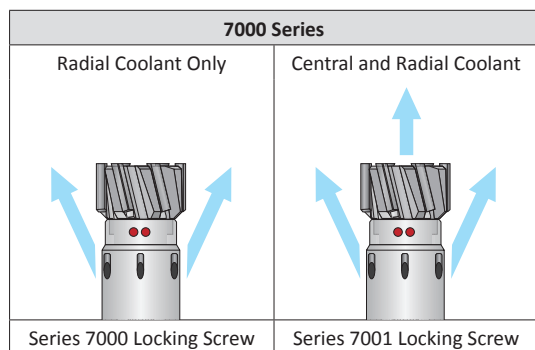

$D_1$ Range		Mandrel			No. of Teeth	Part No.
Imperial (in)	Metric (mm)	$L_2$	$L_1$	$D_2$		
0.4646 - 0.5751	11.800 - 14.609	50	95	12	6	7000-MC-001
0.5752 - 0.6932	14.610 - 17.609	65	113	16	6	7000-MC-002
0.6933 - 0.8507	17.610 - 21.609	75	125	20	6	7000-MC-003
0.8508 - 1.0475	21.610 - 26.609	85	135	20	6	7000-MC-004
1.0476 - 1.2838	26.610 - 32.609	105	161	25	6	7000-MC-005
1.2839 - 1.5987	32.610 - 40.609	120	180	32	6	7000-MC-006
1.5988 - 1.8170	40.610 - 50.600	120	180	32	6	7000-MC-007
1.8171 - 1.9924	45.610 - 50.600	120	180	32	8	7000-MC-075
1.9925 - 2.3858	50.610 - 60.600	120	190	40	8	7000-MC-008

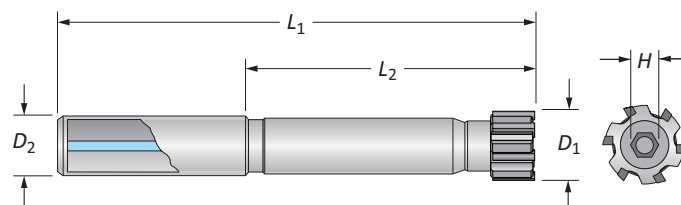
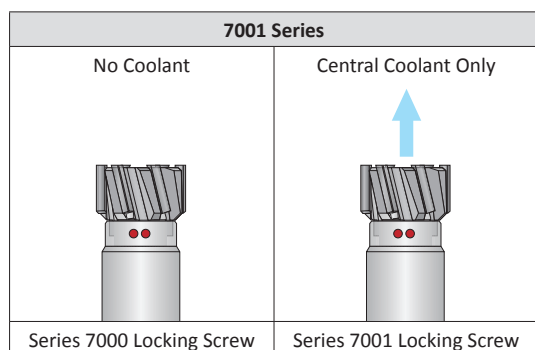

$D_1$ Range		Mandrel			No. of Teeth	Part No.
Imperial (in)	Metric (mm)	$L_2$	$L_1$	$D_2$		
0.4646 - 0.5751	11.800 - 14.609	50	95	12	6	7001-MC-001
0.5752 - 0.6932	14.610 - 17.609	65	113	16	6	7001-MC-002
0.6933 - 0.8507	17.610 - 21.609	75	125	20	6	7001-MC-003
0.8508 - 1.0475	21.610 - 26.609	85	135	20	6	7001-MC-004
1.0476 - 1.2838	26.610 - 32.609	105	161	25	6	7001-MC-005
1.2839 - 1.5987	32.610 - 40.609	120	180	32	6	7001-MC-006
1.5988 - 1.8170	40.610 - 50.600	120	180	32	6	7001-MC-007
1.8171 - 1.9924	45.610 - 50.600	120	180	32	8	7001-MC-075
1.9925 - 2.3858	50.610 - 60.600	120	190	40	8	7001-MC-008

C: 62 - 73

C: 12 - 13

C: 14 - 15

C: 54 - 61

C: 74

Key on C.1

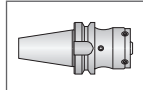
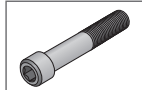
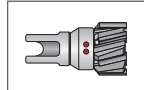
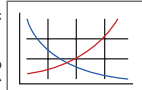

### Application recommendation:

- Through hole application = radial coolant
- Blind hole application = central coolant

## Replaceable Head Mandrels

Long Length | Cylindrical Shank | Diameter Range: 0.4646" - 2.3858" (11.800mm - 60.600mm)

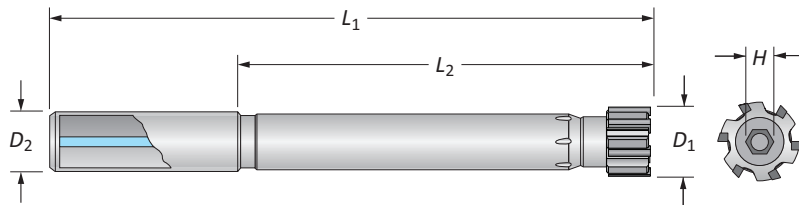
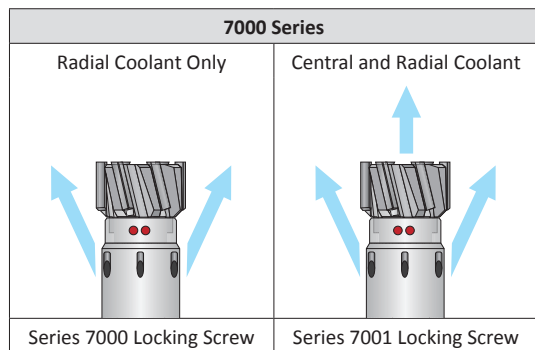

D <sub>1</sub> Range		Mandrel			No. of Teeth	Part No.
Imperial (in)	Metric (mm)	L <sub>2</sub>	L <sub>1</sub>	D <sub>2</sub>		
0.4646 - 0.5751	11.800 - 14.609	95	140	12	6	7000-ML-001
0.5752 - 0.6932	14.610 - 17.609	105	153	16	6	7000-ML-002
0.6933 - 0.8507	17.610 - 21.609	125	175	20	6	7000-ML-003
0.8508 - 1.0475	21.610 - 26.609	145	195	20	6	7000-ML-004
1.0476 - 1.2838	26.610 - 32.609	165	221	25	6	7000-ML-005
1.2839 - 1.5987	32.610 - 40.609	185	245	32	6	7000-ML-006
1.5988 - 1.8170	40.610 - 50.600	185	245	32	6	7000-ML-007
1.8171 - 1.9924	45.610 - 50.600	185	245	32	8	7000-ML-075
1.9925 - 2.3858	50.610 - 60.600	185	255	40	8	7000-ML-008

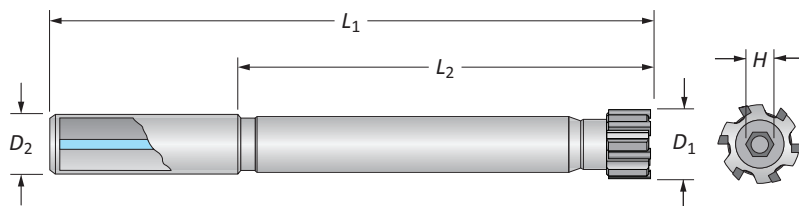
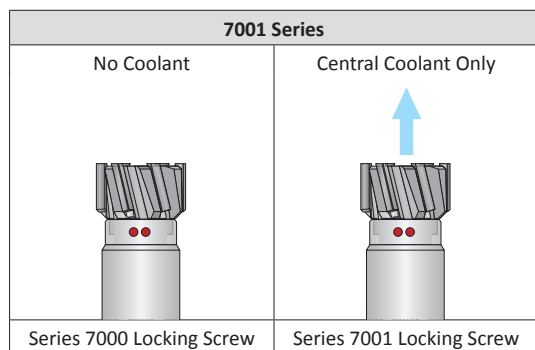

D <sub>1</sub> Range		Mandrel			No. of Teeth	Part No.
Imperial (in)	Metric (mm)	L <sub>2</sub>	L <sub>1</sub>	D <sub>2</sub>		
0.4646 - 0.5751	11.800 - 14.609	95	140	12	6	7001-ML-001
0.5752 - 0.6932	14.610 - 17.609	105	153	16	6	7001-ML-002
0.6933 - 0.8507	17.610 - 21.609	125	175	20	6	7001-ML-003
0.8508 - 1.0475	21.610 - 26.609	145	195	20	6	7001-ML-004
1.0476 - 1.2838	26.610 - 32.609	165	221	25	6	7001-ML-005
1.2839 - 1.5987	32.610 - 40.609	185	245	32	6	7001-ML-006
1.5988 - 1.8170	40.610 - 50.600	185	245	32	6	7001-ML-007
1.8171 - 1.9924	45.610 - 50.600	185	245	32	8	7001-ML-075
1.9925 - 2.3858	50.610 - 60.600	185	255	40	8	7001-ML-008

Key on C-1

C: 62 - 73 	C: 12 - 13 	C: 14 - 15 	C: 54 - 61 	C: 74 
----------------	----------------	----------------	----------------	-----------

**Application recommendation:**

- Through hole application = radial coolant
- Blind hole application = central coolant

## Replaceable Head Mandrels

Standard Length | Modular Shank | Diameter Range: 0.4646" - 2.3858" (11.800mm - 60.600mm)

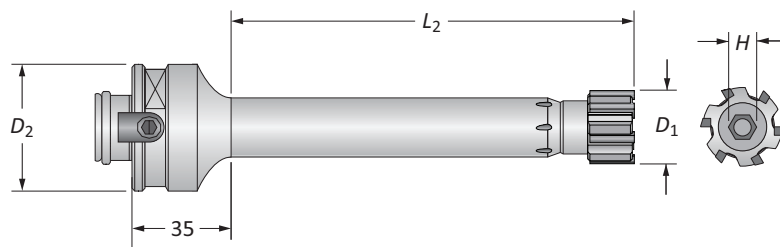
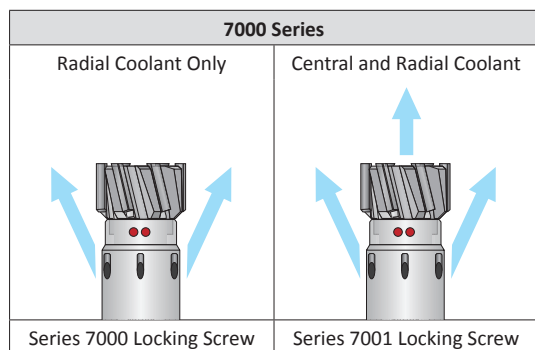

$D_1$ Range		Mandrel		No. of Teeth	Part No.
Imperial (in)	Metric (mm)	$L_2$	$D_2$		
0.4646 - 0.5751	11.800 - 14.609	65	50	6	7000-MM-001
0.5752 - 0.6932	14.610 - 17.609	80	50	6	7000-MM-002
0.6933 - 0.8507	17.610 - 21.609	90	50	6	7000-MM-003
0.8508 - 1.0475	21.610 - 26.609	100	50	6	7000-MM-004
1.0476 - 1.2838	26.610 - 32.609	110	50	6	7000-MM-005
1.2839 - 1.5987	32.610 - 40.609	120	50	6	7000-MM-006
1.5988 - 1.8170	40.610 - 50.600	120	50	6	7000-MM-007
1.8171 - 1.9924	45.610 - 50.600	120	50	8	7000-MM-075
1.9925 - 2.3858	50.610 - 60.600	120	50	8	7000-MM-008

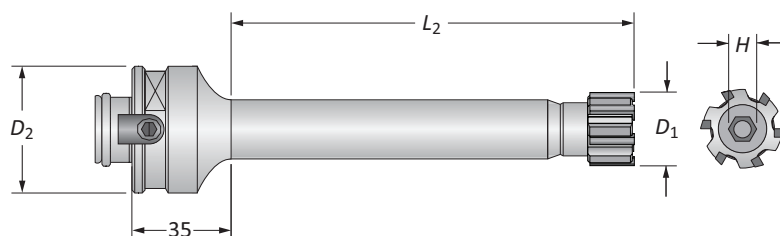
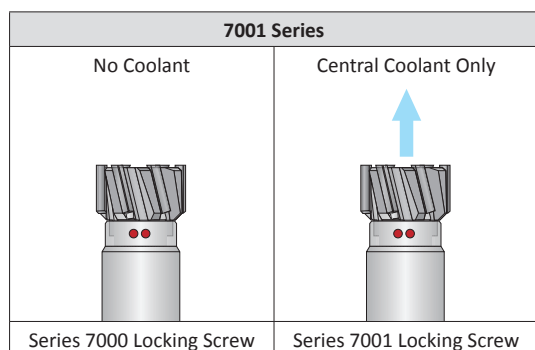

$D_1$ Range		Mandrel		No. of Teeth	Part No.
Imperial (in)	Metric (mm)	$L_2$	$D_2$		
0.4646 - 0.5751	11.800 - 14.609	65	50	6	7001-MM-001
0.5752 - 0.6932	14.610 - 17.609	80	50	6	7001-MM-002
0.6933 - 0.8507	17.610 - 21.609	90	50	6	7001-MM-003
0.8508 - 1.0475	21.610 - 26.609	100	50	6	7001-MM-004
1.0476 - 1.2838	26.610 - 32.609	110	50	6	7001-MM-005
1.2839 - 1.5987	32.610 - 40.609	120	50	6	7001-MM-006
1.5988 - 1.8170	40.610 - 50.600	120	50	6	7001-MM-007
1.8171 - 1.9924	45.610 - 50.600	120	50	8	7001-MM-075
1.9925 - 2.3858	50.610 - 60.600	120	50	8	7001-MM-008

C: 62 - 73

C: 12 - 13

C: 14 - 15

C: 54 - 61

C: 74

Key on C.1

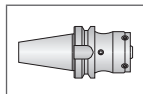
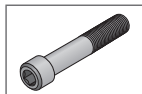
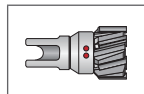
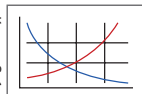

### Application recommendation:

- Through hole application = radial coolant
- Blind hole application = central coolant

## Replaceable Head Mandrels

AR Upper Receiver | Cylindrical Shank | Diameter Range: 1.0000 - 1.1875 (25.40mm - 30.16mm)

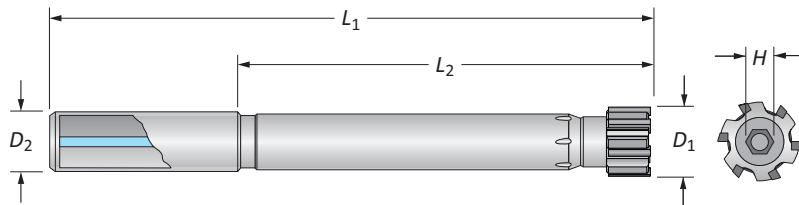
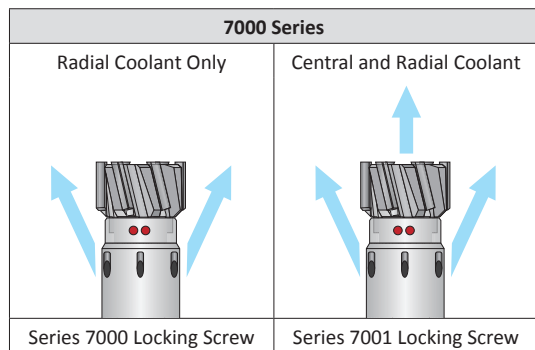

$D_1$		Mandrel			No. of Teeth	Part No.
Imperial (in)	Metric (mm)	$L_2$	$L_1$	$D_2$		
1.1875	30.16	9.65	11.65	0.750	6	7000-MC-AR10
1.0000	25.40	8.66	10.63	0.750	6	7000-MC-AR15

Achieve the **long length of cut** and **surface finish** you need.



## CASE STUDY | AR15 Upper Receiver

Material: 6061 T6 Aluminum

Measure	Carbide-Tipped Chucking Reamer	ALVAN® Replaceable Head Reamer
RPM	1146	2559
Speed	300 SFM	670 SFM
Feed In	0.018 IPR (20.6 IPM)	0.045 IPR (115 IPM)
Feed Out	0.018 IPR (20.6 IPM)	0.090 IPR (230.3 IPM)
Finish	63 Ra	32 Ra
Follow-Up Process	Roller Burnish	None
Cycle Time	0:00:55	0:00:09
Cost-Per-Hole	\$0.77	\$0.26
Total Parts	3,500	3,500
Total Cost	\$2,691.18	\$933.84

**SURFACE FINISH**  $\sqrt{32}$  Ra  
no burnishing required

**123%** ↑ SPEED

**150%** ↑ FEED

**84%** ↓ CYCLE TIME

**65%** ↓ TOTAL COSTS

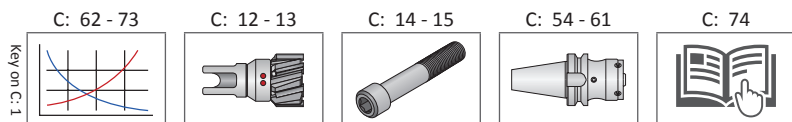

**Application recommendation:**

- Through hole application = radial coolant
- Blind hole application = central coolant

## Monobloc Style Reamers

### Product Overview

#### Monobloc Reamer Features

- Diameter range: 0.2283" - 1.2638" (5.80mm - 32.10mm)
- Available with straight or left hand helical flutes
- Expandable up to 1% of nominal diameter
- Available with cylindrical shanks only
- Work day lead time 20 - 25 days
- Available for recondition

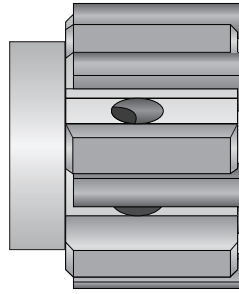

Straight Flute

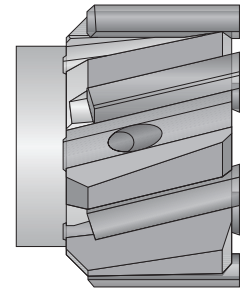

Left Hand Helical Flute



Uncoated



TiN Coated



TiAlN Coated



TiCN Coated



Alcrona Coated

#### Straight Flute - Through or Blind Holes

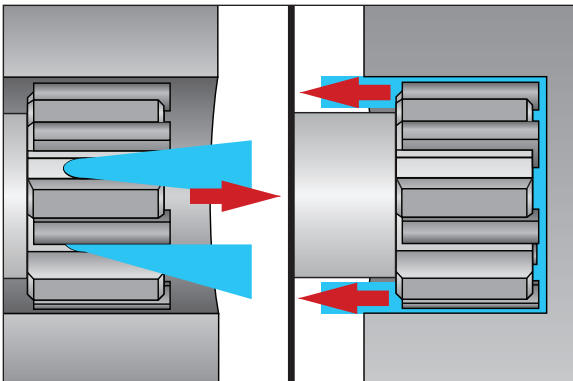

Use for either through hole or blind hole applications. The coolant flow determines the direction of the chip evacuation.

#### Left Hand Helical Flute - Through Holes Only

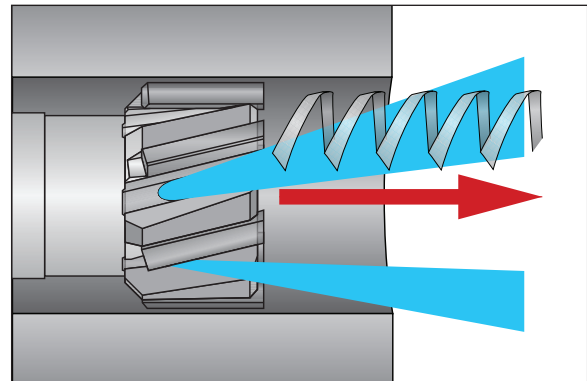

Use when reaming through hole applications. The cutting action of the helical flutes forces the chips forward for evacuation.



## Product Nomenclature

### Monobloc Style Reamers

<b>I</b>	<b>9</b>	<b>2440</b>	-	<b>KL</b>	<b>E</b>	-	<b>006250</b>	+	<b>0000</b>	-	<b>0005</b>
1	2	3		4	5		6		7		

**NOTE:** If diameter and tolerance are specified in inch units, put an "I" at the beginning of the item number

<p><b>1. Units of Measure</b></p> <p><b>Blank</b> = Metric diameter  <b>I</b> = Inch diameter</p>	<p><b>2. Shank Measure</b></p> <p><b>Blank</b> = Metric  <b>9</b> = Inch</p>	<p><b>3. Series</b></p> <p><b>2440</b> = Short length, straight flute - no coolant  <b>2441</b> = Short length, straight flute - central coolant (blind holes)  <b>3620</b> = Short length, straight flute - radial coolant (through holes)  <b>3627</b> = Short length, helical flute - radial coolant (through holes)</p> <p><b>2430</b> = Long length, straight flute - no coolant  <b>2431</b> = Long length, straight flute - central coolant (blind holes)  <b>3610</b> = Long length, straight flute - radial coolant (through holes)  <b>3617</b> = Long length, helical flute - radial coolant (through holes)</p>
<p><b>4. Coating and Substrate</b></p> <p><b>KL</b> = Uncoated carbide      <b>SV</b> = Uncoated cermet  <b>KN</b> = TiN coated carbide    <b>SN</b> = TiN coated cermet  <b>KC</b> = TiCN coated carbide    <b>SC</b> = TiCN coated cermet  <b>KA</b> = TiAlN coated carbide    <b>SA</b> = TiAlN coated cermet  <b>KK</b> = Alcrona coated carbide   <b>SK</b> = Alcrona coated cermet</p>	<p><b>5. Lead-in</b></p> <p><b>E, M, K</b> = Left hand helical flute  <b>A, F, G, L, N, T, V</b> = Straight flute  <b>J, W, X, Y</b> = Straight flute with chipbreaker</p>	
<p><b>6. Diameter</b></p> <p><b>XX.XXXX</b> = Imperial (inch)  <b>XXX.XXX</b> = Metric (mm)</p>	<p><b>7. Tolerance*</b></p> <p><b>4 decimal places</b> = inch tolerance  <b>3 decimal places</b> = mm tolerance</p> <p>*The total tolerance capable is 0.0002" (0.005mm)</p>	

#### Reference Key

Symbol	Attribute
$D_1$	Reamer diameter
$D_2$	Shank diameter
$L_1$	Overall length
$L_2$	Body length
$L_{15}$	Cutting edge length
$H$	Hex key

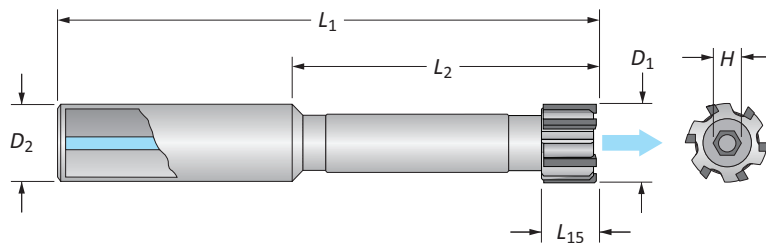

**Monobloc Reamers**

2440 Series | Short Length | Diameter Range: 0.2283" - 1.2638" (5.80mm - 32.10mm)

Series	2440
Flute	Straight
Type	Blind or Through Holes
Coolant	None

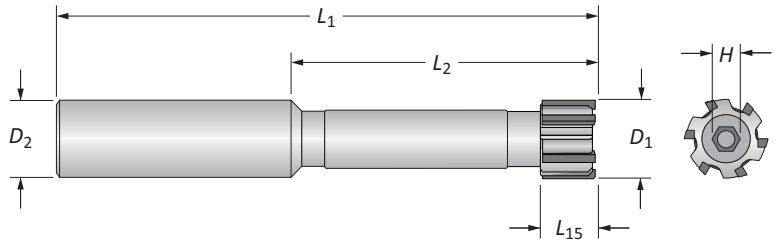

Inch Shank Part No. 92440-CGL-D <sub>1</sub>					Metric Shank Part No. 2440-CGL-D <sub>1</sub>					No. of Teeth	H (mm)
D <sub>1</sub> Range	L <sub>15</sub>	L <sub>2</sub>	L <sub>1</sub>	D <sub>2</sub>	D <sub>1</sub> Range	L <sub>15</sub>	L <sub>2</sub>	L <sub>1</sub>	D <sub>2</sub>		
0.2283 - 0.2598	0.315	1.575	3.150	0.500	5.80 - 6.60	8	40	80	12	4	1.5
0.2599 - 0.2992	0.315	1.575	3.150	0.500	6.61 - 7.60	8	40	80	12	4	2
0.2993 - 0.3386	0.394	1.575	3.150	0.500	7.61 - 8.60	10	40	80	12	4	2.5
0.3387 - 0.3780	0.394	1.969	3.543	0.500	8.61 - 9.60	10	50	90	12	4	2.5
0.3781 - 0.4173	0.394	1.969	3.740	0.500	9.61 - 10.60	10	50	95	12	6	3
0.4174 - 0.4567	0.394	2.362	4.134	0.500	10.61 - 11.60	10	60	105	12	6	3
0.4568 - 0.4961	0.394	2.362	4.134	0.500	11.61 - 12.60	10	60	105	12	6	3
0.4962 - 0.5354	0.394	2.362	4.134	0.500	12.61 - 13.60	10	60	105	12	6	4
0.5355 - 0.5748	0.394	2.362	4.528	0.500	13.61 - 14.60	10	70	115	12	6	4
0.5749 - 0.6142	0.394	2.362	4.528	0.500	14.61 - 15.60	10	70	115	12	6	4
0.6143 - 0.6535	0.394	3.150	5.118	0.625	15.61 - 16.60	10	80	130	16	6	4
0.6536 - 0.6929	0.394	3.150	5.118	0.625	16.61 - 17.60	10	80	130	16	6	5
0.6930 - 0.7323	0.472	3.543	5.512	0.625	17.61 - 18.60	12	90	140	16	6	5
0.7324 - 0.7520	0.472	3.543	5.906	0.750	18.61 - 19.10	12	90	150	20	6	5
0.7521 - 0.7913	0.472	3.937	6.229	0.750	19.11 - 20.10	12	100	160	20	6	5
0.7914 - 0.8307	0.472	3.937	6.229	0.750	20.11 - 21.10	12	100	160	20	6	5
0.8308 - 0.8701	0.472	3.937	6.229	0.750	21.11 - 22.10	12	100	160	20	6	6
0.8702 - 0.9094	0.472	3.937	6.229	0.750	22.11 - 23.10	12	100	160	20	6	6
0.9095 - 0.9488	0.472	3.937	6.229	0.750	23.11 - 24.10	12	100	160	20	6	6
0.9489 - 0.9882	0.472	3.937	6.229	0.750	24.11 - 25.10	12	100	160	20	6	6
0.9883 - 1.0276	0.472	4.331	6.693	1.000	25.11 - 26.10	16	110	170	25	6	6
1.0277 - 1.0669	0.551	4.331	6.693	1.000	26.11 - 27.10	16	110	170	25	6	6
1.0670 - 1.1063	0.551	4.331	6.693	1.000	27.11 - 28.10	16	110	170	25	6	8
1.1064 - 1.1457	0.551	4.331	6.693	1.000	28.11 - 29.10	16	110	170	25	6	8
1.1458 - 1.1850	0.551	4.331	6.693	1.000	29.11 - 30.10	16	110	170	25	6	8
1.1851 - 1.2244	0.551	4.331	6.693	1.000	30.11 - 31.10	16	110	170	25	6	8
1.2245 - 1.2638	0.551	4.331	6.693	1.000	31.11 - 32.10	16	110	170	25	6	8

**"CG" Portion of Item No. (Coating and Substrate Code)**

Grade	Uncoated	TiN	TiCN	TiAlN	Alcrona
Carbide	KL	KN	KC	KA	KK
Cermet	SV	SN	SC	SA	SK

**"L" Portion of Item No. (Lead-in Recommendation)**

ISO Material	T	F	N	G	L	A	V
P			●	●		○	○
S	●			○			
M				●	○		
H			○	●			
K	○			●			○
N				●		●	○

● Best ○ Better ○ Good

**Ordering Example:**

The customer needs the following:

- Metric shank
- Carbide
- TiN coating
- F lead-in
- 30.60mm diameter
- Blind hole
- Flood coolant

**2440-KNF-030600**

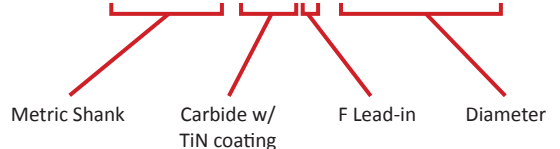

C: 62 - 73

C: 54 - 61

C: 75

## Monobloc Reamers

2441 Series | Short Length | Diameter Range: 0.2283" - 1.2638" (5.80mm - 32.10mm)

Series	2441
Flute	Straight
Type	Blind Holes
Coolant	Central

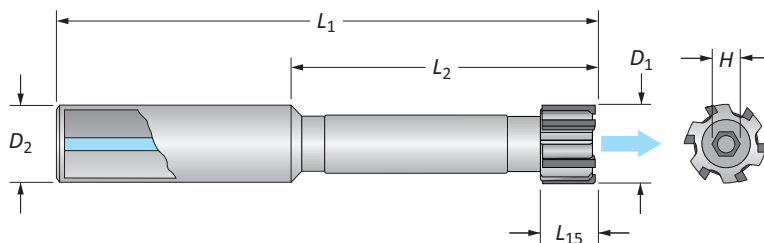

Inch Shank Part No. 92441-CGL-D <sub>1</sub>					Metric Shank Part No. 2441-CGL-D <sub>1</sub>					No. of Teeth	H (mm)
D <sub>1</sub> Range	L <sub>15</sub>	L <sub>2</sub>	L <sub>1</sub>	D <sub>2</sub>	D <sub>1</sub> Range	L <sub>15</sub>	L <sub>2</sub>	L <sub>1</sub>	D <sub>2</sub>		
0.2283 - 0.2598	0.315	1.575	3.071	0.500	5.80 - 6.60	8	40	80	12	4	1.5
0.2599 - 0.2992	0.315	1.575	3.071	0.500	6.61 - 7.60	8	40	80	12	4	2
0.2993 - 0.3386	0.394	1.575	3.071	0.500	7.61 - 8.60	10	40	80	12	4	2.5
0.3387 - 0.3780	0.394	1.969	3.465	0.500	8.61 - 9.60	10	50	90	12	4	2.5
0.3781 - 0.4173	0.394	1.969	3.740	0.500	9.61 - 10.60	10	50	95	12	6	3
0.4174 - 0.4567	0.394	1.969	3.740	0.500	10.61 - 11.60	10	60	105	12	6	3
0.4568 - 0.4961	0.394	1.969	3.740	0.500	11.61 - 12.60	10	60	105	12	6	3
0.4962 - 0.5354	0.394	1.969	3.740	0.500	12.61 - 13.60	10	60	105	12	6	4
0.5355 - 0.5748	0.394	1.969	3.740	0.500	13.61 - 14.60	10	70	115	12	6	4
0.5749 - 0.6142	0.394	1.969	3.740	0.500	14.61 - 15.60	10	70	115	12	6	4
0.6143 - 0.6535	0.394	1.969	3.937	0.625	15.61 - 16.60	10	80	130	16	6	4
0.6536 - 0.6929	0.394	1.969	3.937	0.625	16.61 - 17.60	10	80	130	16	6	5
0.6930 - 0.7323	0.472	1.969	3.937	0.625	17.61 - 18.60	12	90	140	16	6	5
0.7324 - 0.7520	0.472	2.362	4.724	0.750	18.61 - 19.10	12	90	150	20	6	5
0.7521 - 0.7913	0.472	2.362	4.724	0.750	19.11 - 20.10	12	100	160	20	6	5
0.7914 - 0.8307	0.472	2.362	4.724	0.750	20.11 - 21.10	12	100	160	20	6	5
0.8308 - 0.8701	0.472	2.362	4.724	0.750	21.11 - 22.10	12	100	160	20	6	6
0.8702 - 0.9094	0.472	2.362	4.724	0.750	22.11 - 23.10	12	100	160	20	6	6
0.9095 - 0.9488	0.472	2.362	4.724	0.750	23.11 - 24.10	12	100	160	20	6	6
0.9489 - 0.9882	0.472	2.362	4.724	0.750	24.11 - 25.10	12	100	160	20	6	6
0.9883 - 1.0276	0.472	2.953	5.315	1.000	25.11 - 26.10	16	110	170	25	6	6
1.0277 - 1.0669	0.551	2.953	5.315	1.000	26.11 - 27.10	16	110	170	25	6	6
1.0670 - 1.1063	0.551	2.953	5.315	1.000	27.11 - 28.10	16	110	170	25	6	8
1.1064 - 1.1457	0.551	2.953	5.315	1.000	28.11 - 29.10	16	110	170	25	6	8
1.1458 - 1.1850	0.551	2.953	5.315	1.000	29.11 - 30.10	16	110	170	25	6	8
1.1851 - 1.2244	0.551	2.953	5.315	1.000	30.11 - 31.10	16	110	170	25	6	8
1.2245 - 1.2638	0.551	2.953	5.315	1.000	31.11 - 32.10	16	110	170	25	6	8

“CG” Portion of Item No. (Coating and Substrate Code)

Grade	Uncoated	TiN	TiCN	TiAlN	Alcrona
Carbide	KL	KN	KC	KA	KK
Cermet	SV	SN	SC	SA	SK

“L” Portion of Item No. (Lead-in Recommendation)

ISO Material	T	F	N	G	L	A	V
P			●	●		○	○
S	●			○			
M				●	○		
H			○	●			
K	○			●			○
N				●		●	○

● Best ○ Better ○ Good

**Ordering Example:**

The customer needs the following:

- Metric shank
- Carbide
- TiN coating
- F lead-in
- 30.60mm diameter
- Blind hole

**2441-KNF-030600**

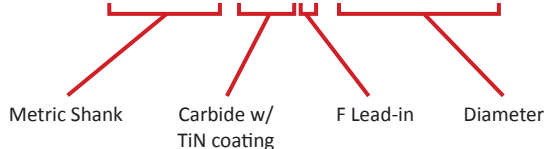

Key on C-1

C: 62 - 73

C: 54 - 61

C: 75

**Monobloc Reamers**

3620 Series | Short Length | Diameter Range: 0.2283" - 1.2638" (5.80mm - 32.10mm)

Series	3620
Flute	Straight
Type	Through Holes
Coolant	Radial

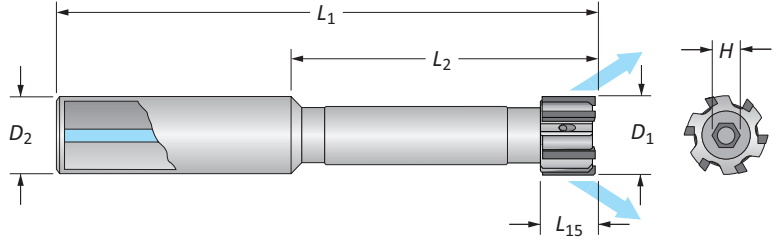

Inch Shank Part No. 93620-CGL-D <sub>1</sub>					Metric Shank Part No. 3620-CGL-D <sub>1</sub>					No. of Teeth	H (mm)
D <sub>1</sub> Range	L <sub>15</sub>	L <sub>2</sub>	L <sub>1</sub>	D <sub>2</sub>	D <sub>1</sub> Range	L <sub>15</sub>	L <sub>2</sub>	L <sub>1</sub>	D <sub>2</sub>		
0.2283 - 0.2598	0.315	1.575	3.071	0.500	5.80 - 6.60	8	40	78	12	4	1.5
0.2599 - 0.2992	0.315	1.575	3.071	0.500	6.61 - 7.60	8	40	78	12	4	2
0.2993 - 0.3386	0.394	1.575	3.071	0.500	7.61 - 8.60	10	40	78	12	4	2.5
0.3387 - 0.3780	0.394	1.969	3.465	0.500	8.61 - 9.60	10	50	88	12	4	2.5
0.3781 - 0.4173	0.394	1.969	3.740	0.500	9.61 - 10.60	10	50	95	12	6	3
0.4174 - 0.4567	0.394	1.969	3.740	0.500	10.61 - 11.60	10	50	95	12	6	3
0.4568 - 0.4961	0.394	1.969	3.740	0.500	11.61 - 12.60	10	50	95	12	6	3
0.4962 - 0.5354	0.394	1.969	3.740	0.500	12.61 - 13.60	10	50	95	12	6	4
0.5355 - 0.5748	0.394	1.969	3.740	0.500	13.61 - 14.60	10	50	95	12	6	4
0.5749 - 0.6142	0.394	1.969	3.740	0.500	14.61 - 15.60	10	50	95	12	6	4
0.6143 - 0.6535	0.394	1.969	3.937	0.625	15.61 - 16.60	10	50	100	16	6	4
0.6536 - 0.6929	0.394	1.969	3.937	0.625	16.61 - 17.60	10	50	100	16	6	5
0.6930 - 0.7323	0.472	1.969	3.937	0.625	17.61 - 18.60	12	50	100	16	6	5
0.7324 - 0.7520	0.472	2.362	4.724	0.750	18.61 - 19.10	12	60	120	20	6	5
0.7521 - 0.7913	0.472	2.362	4.724	0.750	19.11 - 20.10	12	60	120	20	6	5
0.7914 - 0.8307	0.472	2.362	4.724	0.750	20.11 - 21.10	12	60	120	20	6	5
0.8308 - 0.8701	0.472	2.362	4.724	0.750	21.11 - 22.10	12	60	120	20	6	6
0.8702 - 0.9094	0.472	2.362	4.724	0.750	22.11 - 23.10	12	60	120	20	6	6
0.9095 - 0.9488	0.472	2.362	4.724	0.750	23.11 - 24.10	12	60	120	20	6	6
0.9489 - 0.9882	0.472	2.362	4.724	0.750	24.11 - 25.10	12	60	120	20	6	6
0.9883 - 1.0276	0.472	2.953	5.315	1.000	25.11 - 26.10	16	70	135	25	6	6
1.0277 - 1.0669	0.551	2.953	5.315	1.000	26.11 - 27.10	16	70	135	25	6	6
1.0670 - 1.1063	0.551	2.953	5.315	1.000	27.11 - 28.10	16	70	135	25	6	8
1.1064 - 1.1457	0.551	2.953	5.315	1.000	28.11 - 29.10	16	70	135	25	6	8
1.1458 - 1.1850	0.551	2.953	5.315	1.000	29.11 - 30.10	16	70	135	25	6	8
1.1851 - 1.2244	0.551	2.953	5.315	1.000	30.11 - 31.10	16	70	135	25	6	8
1.2245 - 1.2638	0.551	2.953	5.315	1.000	31.11 - 32.10	16	70	135	25	6	8

**"CG" Portion of Item No. (Coating and Substrate Code)**

Grade	Uncoated	TiN	TiCN	TiAlN	Alcrona
Carbide	KL	KN	KC	KA	KK
Cermet	SV	SN	SC	SA	SK

**"L" Portion of Item No. (Lead-in Recommendation)**

ISO Material	T	F	N	G	L	A	V
P			●	●		○	○
S	●			○			
M				●	○		
H			○	●			
K	○			●			○
N				●		●	○

● Best ○ Better ○ Good

**Ordering Example:**

The customer needs the following:

- Metric shank
- Carbide
- TiN coating
- F lead-in
- 30.60mm diameter
- Through hole

**3620-KNF-030600**

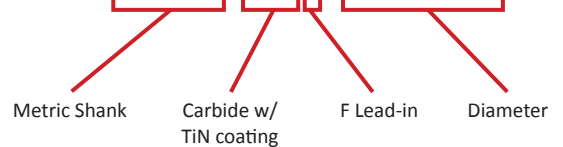

Key on C: 1

C: 62 - 73

C: 54 - 61

C: 75

### Monobloc Reamers

3627 Series | Short Length | Diameter Range: 0.2283" - 1.2638" (5.80mm - 32.10mm)

Series	3627
Flute	Helical
Type	Through Holes
Coolant	Radial

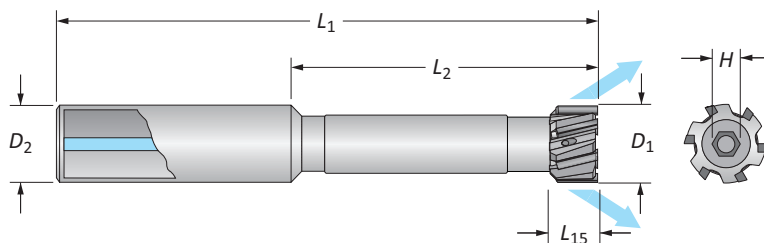

Inch Shank Part No. 93627-CGL-D <sub>1</sub>					Metric Shank Part No. 3627-CGL-D <sub>1</sub>					No. of Teeth	H (mm)
D <sub>1</sub> Range	L <sub>15</sub>	L <sub>2</sub>	L <sub>1</sub>	D <sub>2</sub>	D <sub>1</sub> Range	L <sub>15</sub>	L <sub>2</sub>	L <sub>1</sub>	D <sub>2</sub>		
0.2283 - 0.2598	0.315	1.575	3.150	0.500	5.80 - 6.60	8	40	80	12	4	1.5
0.2599 - 0.2992	0.315	1.575	3.150	0.500	6.61 - 7.60	8	40	80	12	4	2
0.2993 - 0.3386	0.394	1.575	3.150	0.500	7.61 - 8.60	10	40	80	12	4	2.5
0.3387 - 0.3780	0.394	1.969	3.543	0.500	8.61 - 9.60	10	50	90	12	4	2.5
0.3781 - 0.4173	0.394	1.969	3.740	0.500	9.61 - 10.60	10	50	95	12	6	3
0.4174 - 0.4567	0.394	2.362	4.134	0.500	10.61 - 11.60	10	60	105	12	6	3
0.4568 - 0.4961	0.394	2.362	4.134	0.500	11.61 - 12.60	10	60	105	12	6	3
0.4962 - 0.5354	0.394	2.362	4.134	0.500	12.61 - 13.60	10	60	105	12	6	4
0.5355 - 0.5748	0.394	2.756	4.528	0.500	13.61 - 14.60	10	70	115	12	6	4
0.5749 - 0.6142	0.394	2.756	4.528	0.500	14.61 - 15.60	10	70	115	12	6	4
0.6143 - 0.6535	0.394	3.150	5.118	0.625	15.61 - 16.60	10	80	130	16	6	4
0.6536 - 0.6929	0.394	3.150	5.118	0.625	16.61 - 17.60	10	80	130	16	6	5
0.6930 - 0.7323	0.472	3.543	5.512	0.625	17.61 - 18.60	12	90	140	16	6	5
0.7324 - 0.7520	0.472	3.543	5.906	0.750	18.61 - 19.10	12	90	150	20	6	5
0.7521 - 0.7913	0.472	3.937	6.299	0.750	19.11 - 20.10	12	100	160	20	6	5
0.7914 - 0.8307	0.472	3.937	6.299	0.750	20.11 - 21.10	12	100	160	20	6	5
0.8308 - 0.8701	0.472	3.937	6.299	0.750	21.11 - 22.10	12	100	160	20	6	6
0.8702 - 0.9094	0.472	3.937	6.299	0.750	22.11 - 23.10	12	100	160	20	6	6
0.9095 - 0.9488	0.472	3.937	6.299	0.750	23.11 - 24.10	12	100	160	20	6	6
0.9489 - 0.9882	0.472	3.937	6.299	0.750	24.11 - 25.10	12	100	160	20	6	6
0.9883 - 1.0276	0.472	4.331	6.693	1.000	25.11 - 26.10	16	110	170	25	6	6
1.0277 - 1.0669	0.551	4.331	6.693	1.000	26.11 - 27.10	16	110	170	25	6	6
1.0670 - 1.1063	0.551	4.331	6.693	1.000	27.11 - 28.10	16	110	170	25	6	8
1.1064 - 1.1457	0.551	4.331	6.693	1.000	28.11 - 29.10	16	110	170	25	6	8
1.1458 - 1.1850	0.551	4.331	6.693	1.000	29.11 - 30.10	16	110	170	25	6	8
1.1851 - 1.2244	0.551	4.331	6.693	1.000	30.11 - 31.10	16	110	170	25	6	8
1.2245 - 1.2638	0.551	4.331	6.693	1.000	31.11 - 32.10	16	110	170	25	6	8

“CG” Portion of Item No. (Coating and Substrate Code)

Grade	Uncoated	TiN	TiCN	TiAlN	Alcrona
Carbide	KL	KN	KC	KA	KK
Cermet	SV	SN	SC	SA	SK

“L” Portion of Item No. (Lead-in Recommendation)

ISO Material	T	F	N	G	L	A	V
P			●	●		○	○
S	●			○			
M				●	○		
H			○	●			
K	○			●			○
N				●		●	○

● Best ○ Better ○ Good

**Ordering Example:**

The customer needs the following:

- Metric shank
- Carbide
- TiN coating
- F lead-in
- 30.60mm diameter
- Through hole

**3627-KNF-030600**

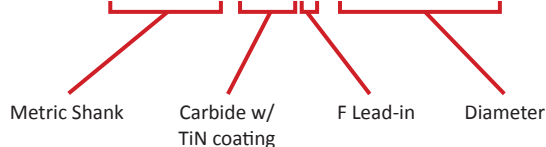

Key on C-1

C: 62 - 73

C: 54 - 61

C: 75

## Monobloc Reamers

2430 Series | Long length | Diameter range: 0.2283" - 1.2638" (5.80mm - 32.10mm)

Series	2430
Flute	Straight
Type	Blind or Through Holes
Coolant	None

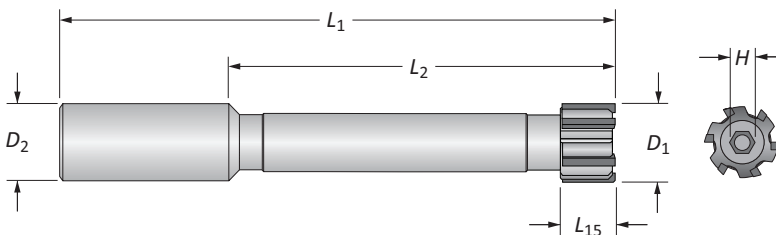

Inch Shank Part No. 92430-CGL-D <sub>1</sub>					Metric Shank Part No. 2430-CGL-D <sub>1</sub>					No. of Teeth	H (mm)
D <sub>1</sub> Range	L <sub>15</sub>	L <sub>2</sub>	L <sub>1</sub>	D <sub>2</sub>	D <sub>1</sub> Range	L <sub>15</sub>	L <sub>2</sub>	L <sub>1</sub>	D <sub>2</sub>		
0.2283 - 0.2598	0.315	3.346	4.843	0.500	5.80 - 6.60	8	85	123	12	4	1.5
0.2599 - 0.2992	0.315	3.346	4.843	0.500	6.61 - 7.60	8	85	123	12	4	2
0.2993 - 0.3386	0.394	3.346	4.843	0.500	7.61 - 8.60	10	85	123	12	4	2.5
0.3387 - 0.3780	0.394	3.346	4.843	0.500	8.61 - 9.60	10	85	123	12	4	2.5
0.3781 - 0.4173	0.394	4.528	6.299	0.500	9.61 - 10.60	10	115	160	12	6	3
0.4174 - 0.4567	0.394	4.528	6.299	0.500	10.61 - 11.60	10	115	160	12	6	3
0.4568 - 0.4961	0.394	4.528	6.299	0.500	11.61 - 12.60	10	115	160	12	6	3
0.4962 - 0.5354	0.394	4.528	6.299	0.500	12.61 - 13.60	10	115	160	12	6	4
0.5355 - 0.5748	0.394	4.528	6.299	0.500	13.61 - 14.60	10	115	160	12	6	4
0.5749 - 0.6142	0.394	4.528	6.299	0.500	14.61 - 15.60	10	115	160	12	6	4
0.6143 - 0.6535	0.394	5.118	7.087	0.625	15.61 - 16.60	10	130	180	16	6	4
0.6536 - 0.6929	0.394	5.118	7.087	0.625	16.61 - 17.60	10	130	180	16	6	5
0.6930 - 0.7323	0.472	5.118	7.087	0.625	17.61 - 18.60	12	130	180	16	6	5
0.7324 - 0.7520	0.472	5.512	7.874	0.750	18.61 - 19.10	12	140	200	20	6	5
0.7521 - 0.7913	0.472	5.512	7.874	0.750	19.11 - 20.10	12	140	200	20	6	5
0.7914 - 0.8307	0.472	5.512	7.874	0.750	20.11 - 21.10	12	140	200	20	6	5
0.8308 - 0.8701	0.472	5.512	7.874	0.750	21.11 - 22.10	12	140	200	20	6	6
0.8702 - 0.9094	0.472	5.512	7.874	0.750	22.11 - 23.10	12	140	200	20	6	6
0.9095 - 0.9488	0.472	5.512	7.874	0.750	23.11 - 24.10	12	140	200	20	6	6
0.9489 - 0.9882	0.472	5.512	7.874	0.750	24.11 - 25.10	12	140	200	20	6	6
0.9883 - 1.0276	0.472	5.906	8.268	1.000	25.11 - 26.10	16	150	210	25	6	6
1.0277 - 1.0669	0.551	5.906	8.268	1.000	26.11 - 27.10	16	150	210	25	6	6
1.0670 - 1.1063	0.551	5.906	8.268	1.000	27.11 - 28.10	16	150	210	25	6	8
1.1064 - 1.1457	0.551	5.906	8.268	1.000	28.11 - 29.10	16	150	210	25	6	8
1.1458 - 1.1850	0.551	5.906	8.268	1.000	29.11 - 30.10	16	150	210	25	6	8
1.1851 - 1.2244	0.551	5.906	8.268	1.000	30.11 - 31.10	16	150	210	25	6	8
1.2245 - 1.2638	0.551	5.906	8.268	1.000	31.11 - 32.10	16	150	210	25	6	8

### "CG" Portion of Item No. (Coating and Substrate Code)

Grade	Uncoated	TiN	TiCN	TiAlN	Alcrona
Carbide	KL	KN	KC	KA	KK
Cermet	SV	SN	SC	SA	SK

### "L" Portion of Item No. (Lead-in Recommendation)

ISO Material	T	F	N	G	L	A	V
P			●	●		○	○
S	●			○			
M				●	○		
H			○	●			
K	○			●			○
N				●		●	○

● Best ○ Better ○ Good

### Ordering Example:

The customer needs the following:

- Metric shank
- Carbide
- TiN coating
- F lead-in
- 30.60mm diameter
- Blind hole
- Flood coolant

**2430-KNF-030600**

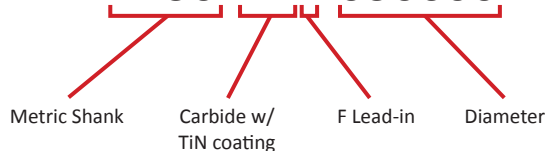

Key on C-1

C: 62 - 73

C: 54 - 61

C: 75

### Monobloc Reamers

2431 Series | Long Length | Diameter Range: 0.2283" - 1.2638" (5.80mm - 32.10mm)

Series	2431
Flute	Straight
Type	Blind Holes
Coolant	Central

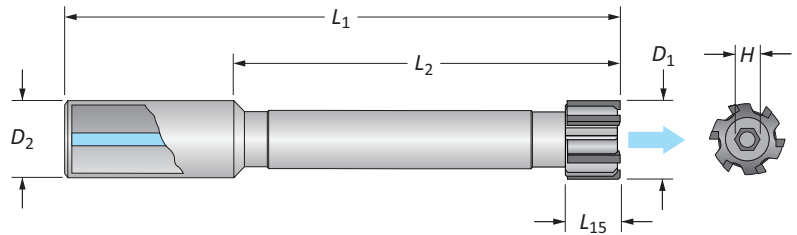

Inch Shank Part No. 92431-CGL-D <sub>1</sub>					Metric Shank Part No. 2431-CGL-D <sub>1</sub>					No. of Teeth	H (mm)
D <sub>1</sub> Range	L <sub>15</sub>	L <sub>2</sub>	L <sub>1</sub>	D <sub>2</sub>	D <sub>1</sub> Range	L <sub>15</sub>	L <sub>2</sub>	L <sub>1</sub>	D <sub>2</sub>		
0.2283 - 0.2598	0.315	3.346	4.843	0.500	5.80 - 6.60	8	85	123	12	4	1.5
0.2599 - 0.2992	0.315	3.346	4.843	0.500	6.61 - 7.60	8	85	123	12	4	2
0.2993 - 0.3386	0.394	3.346	4.843	0.500	7.61 - 8.60	10	85	123	12	4	2.5
0.3387 - 0.3780	0.394	3.346	4.843	0.500	8.61 - 9.60	10	85	123	12	4	2.5
0.3781 - 0.4173	0.394	4.528	6.299	0.500	9.61 - 10.60	10	115	160	12	6	3
0.4174 - 0.4567	0.394	4.528	6.299	0.500	10.61 - 11.60	10	115	160	12	6	3
0.4568 - 0.4961	0.394	4.528	6.299	0.500	11.61 - 12.60	10	115	160	12	6	3
0.4962 - 0.5354	0.394	4.528	6.299	0.500	12.61 - 13.60	10	115	160	12	6	4
0.5355 - 0.5748	0.394	4.528	6.299	0.500	13.61 - 14.60	10	115	160	12	6	4
0.5749 - 0.6142	0.394	4.528	6.299	0.500	14.61 - 15.60	10	115	160	12	6	4
0.6143 - 0.6535	0.394	5.118	7.087	0.625	15.61 - 16.60	10	130	180	16	6	4
0.6536 - 0.6929	0.394	5.118	7.087	0.625	16.61 - 17.60	10	130	180	16	6	5
0.6930 - 0.7323	0.472	5.118	7.087	0.625	17.61 - 18.60	12	130	180	16	6	5
0.7324 - 0.7520	0.472	5.512	7.874	0.750	18.61 - 19.10	12	140	200	20	6	5
0.7521 - 0.7913	0.472	5.512	7.874	0.750	19.11 - 20.10	12	140	200	20	6	5
0.7914 - 0.8307	0.472	5.512	7.874	0.750	20.11 - 21.10	12	140	200	20	6	5
0.8308 - 0.8701	0.472	5.512	7.874	0.750	21.11 - 22.10	12	140	200	20	6	6
0.8702 - 0.9094	0.472	5.512	7.874	0.750	22.11 - 23.10	12	140	200	20	6	6
0.9095 - 0.9488	0.472	5.512	7.874	0.750	23.11 - 24.10	12	140	200	20	6	6
0.9489 - 0.9882	0.472	5.512	7.874	0.750	24.11 - 25.10	12	140	200	20	6	6
0.9883 - 1.0276	0.472	5.906	8.268	1.000	25.11 - 26.10	16	150	210	25	6	6
1.0277 - 1.0669	0.551	5.906	8.268	1.000	26.11 - 27.10	16	150	210	25	6	6
1.0670 - 1.1063	0.551	5.906	8.268	1.000	27.11 - 28.10	16	150	210	25	6	8
1.1064 - 1.1457	0.551	5.906	8.268	1.000	28.11 - 29.10	16	150	210	25	6	8
1.1458 - 1.1850	0.551	5.906	8.268	1.000	29.11 - 30.10	16	150	210	25	6	8
1.1851 - 1.2244	0.551	5.906	8.268	1.000	30.11 - 31.10	16	150	210	25	6	8
1.2245 - 1.2638	0.551	5.906	8.268	1.000	31.11 - 32.10	16	150	210	25	6	8

“CG” Portion of Item No. (Coating and Substrate Code)

Grade	Uncoated	TiN	TiCN	TiAlN	Alcrona
Carbide	KL	KN	KC	KA	KK
Cermet	SV	SN	SC	SA	SK

“L” Portion of Item No. (Lead-in Recommendation)

ISO Material	T	F	N	G	L	A	V
P			●	●		○	○
S	●			○			
M				●	○		
H			○	●			
K	○			●			○
N				●		●	○

● Best ○ Better ○ Good

**Ordering Example:**

The customer needs the following:

- Metric shank
- Carbide
- TiN coating
- F lead-in
- 30.60mm diameter
- Blind hole

**2431-KNF-030600**

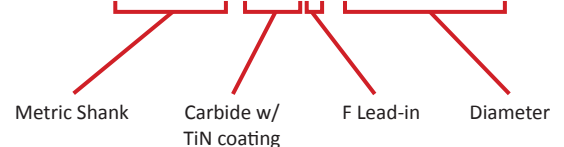

Key on C-1

C: 62 - 73

C: 54 - 61

C: 75

## Monobloc Reamers

3610 Series | Long Length | Diameter Range: 0.2283" - 1.2638" (5.80mm - 32.10mm)

Series	3610
Flute	Straight
Type	Through Holes
Coolant	Radial

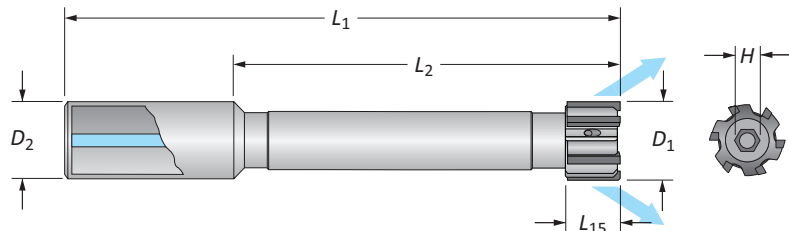

Inch Shank Part No. 93610-CGL-D <sub>1</sub>					Metric Shank Part No. 3610-CGL-D <sub>1</sub>					No. of Teeth	H (mm)
D <sub>1</sub> Range	L <sub>15</sub>	L <sub>2</sub>	L <sub>1</sub>	D <sub>2</sub>	D <sub>1</sub> Range	L <sub>15</sub>	L <sub>2</sub>	L <sub>1</sub>	D <sub>2</sub>		
0.2283 - 0.2598	0.315	3.346	4.843	0.500	5.80 - 6.60	8	85	123	12	4	1.5
0.2599 - 0.2992	0.315	3.346	4.843	0.500	6.61 - 7.60	8	85	123	12	4	2
0.2993 - 0.3386	0.394	3.346	4.843	0.500	7.61 - 8.60	10	85	123	12	4	2.5
0.3387 - 0.3780	0.394	3.346	4.843	0.500	8.61 - 9.60	10	85	123	12	4	2.5
0.3781 - 0.4173	0.394	4.528	6.299	0.500	9.61 - 10.60	10	115	160	12	6	3
0.4174 - 0.4567	0.394	4.528	6.299	0.500	10.61 - 11.60	10	115	160	12	6	3
0.4568 - 0.4961	0.394	4.528	6.299	0.500	11.61 - 12.60	10	115	160	12	6	3
0.4962 - 0.5354	0.394	4.528	6.299	0.500	12.61 - 13.60	10	115	160	12	6	4
0.5355 - 0.5748	0.394	4.528	6.299	0.500	13.61 - 14.60	10	115	160	12	6	4
0.5749 - 0.6142	0.394	4.528	6.299	0.500	14.61 - 15.60	10	115	160	12	6	4
0.6143 - 0.6535	0.394	5.118	7.087	0.625	15.61 - 16.60	10	130	180	16	6	4
0.6536 - 0.6929	0.394	5.118	7.087	0.625	16.61 - 17.60	10	130	180	16	6	5
0.6930 - 0.7323	0.472	5.118	7.087	0.625	17.61 - 18.60	12	130	180	16	6	5
0.7324 - 0.7520	0.472	5.512	7.874	0.750	18.61 - 19.10	12	140	200	20	6	5
0.7521 - 0.7913	0.472	5.512	7.874	0.750	19.11 - 20.10	12	140	200	20	6	5
0.7914 - 0.8307	0.472	5.512	7.874	0.750	20.11 - 21.10	12	140	200	20	6	5
0.8308 - 0.8701	0.472	5.512	7.874	0.750	21.11 - 22.10	12	140	200	20	6	6
0.8702 - 0.9094	0.472	5.512	7.874	0.750	22.11 - 23.10	12	140	200	20	6	6
0.9095 - 0.9488	0.472	5.512	7.874	0.750	23.11 - 24.10	12	140	200	20	6	6
0.9489 - 0.9882	0.472	5.512	7.874	0.750	24.11 - 25.10	12	140	200	20	6	6
0.9883 - 1.0276	0.472	5.906	8.268	1.000	25.11 - 26.10	16	150	210	25	6	6
1.0277 - 1.0669	0.551	5.906	8.268	1.000	26.11 - 27.10	16	150	210	25	6	6
1.0670 - 1.1063	0.551	5.906	8.268	1.000	27.11 - 28.10	16	150	210	25	6	8
1.1064 - 1.1457	0.551	5.906	8.268	1.000	28.11 - 29.10	16	150	210	25	6	8
1.1458 - 1.1850	0.551	5.906	8.268	1.000	29.11 - 30.10	16	150	210	25	6	8
1.1851 - 1.2244	0.551	5.906	8.268	1.000	30.11 - 31.10	16	150	210	25	6	8
1.2245 - 1.2638	0.551	5.906	8.268	1.000	31.11 - 32.10	16	150	210	25	6	8

### "CG" Portion of Item No. (Coating and Substrate Code)

Grade	Uncoated	TiN	TiCN	TiAlN	Alcrona
Carbide	KL	KN	KC	KA	KK
Cermet	SV	SN	SC	SA	SK

### "L" Portion of Item No. (Lead-in Recommendation)

ISO Material	T	F	N	G	L	A	V
P			●	●		○	○
S	●			○			
M				●	○		
H			○	●			
K	○			●			○
N				●		●	○

● Best ○ Better ○ Good

**Ordering Example:**  
The customer needs the following:

- Metric shank
- Carbide
- TiN coating
- F lead-in
- 30.60mm diameter
- Through hole

**3610-KNF-030600**

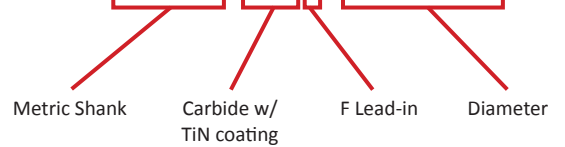

Key on C: 1

C: 62 - 73

C: 54 - 61

C: 75



### Monobloc Reamers

3617 Series | Long Length | Diameter Range: 0.2283" - 1.2638" (5.80mm - 32.10mm)

Series	3617
Flute	Helical
Type	Through Holes
Coolant	Radial

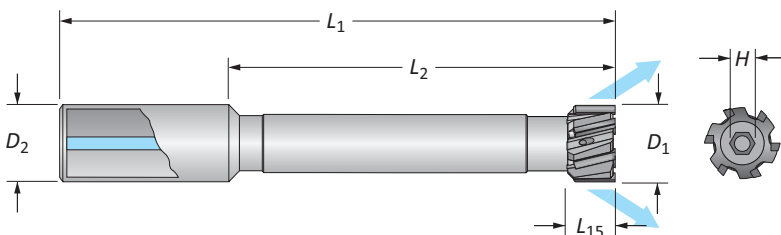

Inch Shank Part No. 93617-CGL-D <sub>1</sub>					Metric Shank Part No. 3617-CGL-D <sub>1</sub>					No. of Teeth	H (mm)
D <sub>1</sub> Range	L <sub>15</sub>	L <sub>2</sub>	L <sub>1</sub>	D <sub>2</sub>	D <sub>1</sub> Range	L <sub>15</sub>	L <sub>2</sub>	L <sub>1</sub>	D <sub>2</sub>		
0.2283 - 0.2598	0.315	3.346	4.843	0.500	5.80 - 6.60	8	85	123	12	4	1.5
0.2599 - 0.2992	0.315	3.346	4.843	0.500	6.61 - 7.60	8	85	123	12	4	2
0.2993 - 0.3386	0.394	3.346	4.843	0.500	7.61 - 8.60	10	85	123	12	4	2.5
0.3387 - 0.3780	0.394	3.346	4.843	0.500	8.61 - 9.60	10	85	123	12	4	2.5
0.3781 - 0.4173	0.394	4.528	6.299	0.500	9.61 - 10.60	10	115	160	12	6	3
0.4174 - 0.4567	0.394	4.528	6.299	0.500	10.61 - 11.60	10	115	160	12	6	3
0.4568 - 0.4961	0.394	4.528	6.299	0.500	11.61 - 12.60	10	115	160	12	6	3
0.4962 - 0.5354	0.394	4.528	6.299	0.500	12.61 - 13.60	10	115	160	12	6	4
0.5355 - 0.5748	0.394	4.528	6.299	0.500	13.61 - 14.60	10	115	160	12	6	4
0.5749 - 0.6142	0.394	4.528	6.299	0.500	14.61 - 15.60	10	115	160	12	6	4
0.6143 - 0.6535	0.394	5.118	7.087	0.625	15.61 - 16.60	10	130	180	16	6	4
0.6536 - 0.6929	0.394	5.118	7.087	0.625	16.61 - 17.60	10	130	180	16	6	5
0.6930 - 0.7323	0.472	5.118	7.087	0.625	17.61 - 18.60	12	130	180	16	6	5
0.7324 - 0.7520	0.472	5.512	7.874	0.750	18.61 - 19.10	12	140	200	20	6	5
0.7521 - 0.7913	0.472	5.512	7.874	0.750	19.11 - 20.10	12	140	200	20	6	5
0.7914 - 0.8307	0.472	5.512	7.874	0.750	20.11 - 21.10	12	140	200	20	6	5
0.8308 - 0.8701	0.472	5.512	7.874	0.750	21.11 - 22.10	12	140	200	20	6	6
0.8702 - 0.9094	0.472	5.512	7.874	0.750	22.11 - 23.10	12	140	200	20	6	6
0.9095 - 0.9488	0.472	5.512	7.874	0.750	23.11 - 24.10	12	140	200	20	6	6
0.9489 - 0.9882	0.472	5.512	7.874	0.750	24.11 - 25.10	12	140	200	20	6	6
0.9883 - 1.0276	0.472	5.906	8.268	1.000	25.11 - 26.10	16	150	210	25	6	6
1.0277 - 1.0669	0.551	5.906	8.268	1.000	26.11 - 27.10	16	150	210	25	6	6
1.0670 - 1.1063	0.551	5.906	8.268	1.000	27.11 - 28.10	16	150	210	25	6	8
1.1064 - 1.1457	0.551	5.906	8.268	1.000	28.11 - 29.10	16	150	210	25	6	8
1.1458 - 1.1850	0.551	5.906	8.268	1.000	29.11 - 30.10	16	150	210	25	6	8
1.1851 - 1.2244	0.551	5.906	8.268	1.000	30.11 - 31.10	16	150	210	25	6	8
1.2245 - 1.2638	0.551	5.906	8.268	1.000	31.11 - 32.10	16	150	210	25	6	8

“CG” Portion of Item No. (Coating and Substrate Code)

Grade	Uncoated	TiN	TiCN	TiAlN	Alcrona
Carbide	KL	KN	KC	KA	KK
Cermet	SV	SN	SC	SA	SK

“L” Portion of Item No. (Lead-in Recommendation)

ISO Material	T	F	N	G	L	A	V
P			●	●		○	○
S	●			○			
M				●	○		
H			○	●			
K	○			●			○
N				●		●	○

● Best ○ Better ○ Good

**Ordering Example:**

The customer needs the following:

- Metric shank
- Carbide
- TiN coating
- F lead-in
- 30.60mm diameter
- Through hole

**3617-KNF-030600**

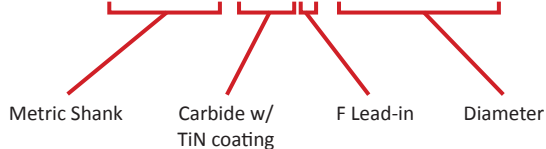

Key on C-1

C: 62 - 73

C: 54 - 61

C: 75

## Cutting Ring Style Reamers

### Product Overview

#### Cutting Ring Reamer Features

- Diameter range: 0.6929" - 7.8972" (17.60mm - 200.59mm)
- Available with straight or left hand helical flutes
- Expandable up to 4% of nominal diameter
- Mandrels are available for both through holes or blind holes
- Work day lead time 20 - 25 days
- Available for recondition

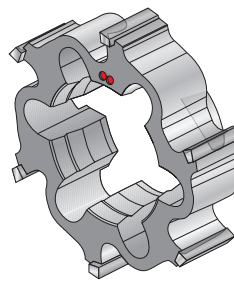

Straight Flute

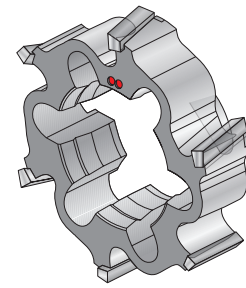

Left Hand Helical Flute



Uncoated



TiN Coated



TiAlN Coated



TiCN Coated



Alcrona Coated

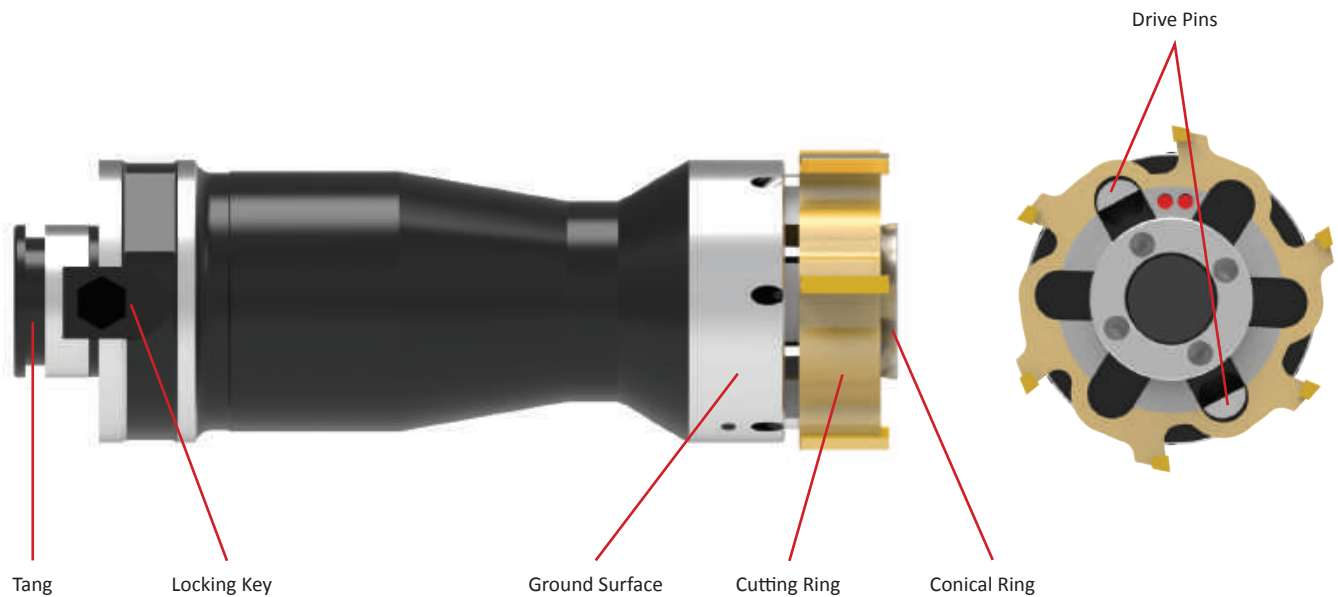



## Product Nomenclature

### Cutting Rings

<b>I</b>	-	<b>2ANC-KT</b>	-	<b>F</b>	-	<b>019686</b>	+	<b>0000</b>	-	<b>0005</b>
1		2		3		4		5		

**NOTE:** If diameter and tolerance are specified in inch units, put an "I" at the beginning of the item number

<b>1. Cutting Ring</b> Blank = Metric diameter I = Inch diameter	<b>2. Coating and Substrate</b> <table border="0"> <tr> <td><b>2000-KT</b> = Uncoated carbide</td> <td><b>2AVC-ST</b> = Uncoated cermet</td> </tr> <tr> <td><b>2TIN-KT</b> = TiN coated carbide</td> <td><b>2ANC-ST</b> = TiN coated cermet</td> </tr> <tr> <td><b>2TIC-KT</b> = TiCN coated carbide</td> <td><b>2ACC-ST</b> = TiCN coated cermet</td> </tr> <tr> <td><b>2TIA-KT</b> = TiAlN coated carbide</td> <td><b>2AAC-ST</b> = TiAlN coated cermet</td> </tr> <tr> <td><b>2TLK-KT</b> = Alcrona coated carbide</td> <td><b>2ALK-ST</b> = Alcrona coated cermet</td> </tr> </table>		<b>2000-KT</b> = Uncoated carbide	<b>2AVC-ST</b> = Uncoated cermet	<b>2TIN-KT</b> = TiN coated carbide	<b>2ANC-ST</b> = TiN coated cermet	<b>2TIC-KT</b> = TiCN coated carbide	<b>2ACC-ST</b> = TiCN coated cermet	<b>2TIA-KT</b> = TiAlN coated carbide	<b>2AAC-ST</b> = TiAlN coated cermet	<b>2TLK-KT</b> = Alcrona coated carbide	<b>2ALK-ST</b> = Alcrona coated cermet
<b>2000-KT</b> = Uncoated carbide	<b>2AVC-ST</b> = Uncoated cermet											
<b>2TIN-KT</b> = TiN coated carbide	<b>2ANC-ST</b> = TiN coated cermet											
<b>2TIC-KT</b> = TiCN coated carbide	<b>2ACC-ST</b> = TiCN coated cermet											
<b>2TIA-KT</b> = TiAlN coated carbide	<b>2AAC-ST</b> = TiAlN coated cermet											
<b>2TLK-KT</b> = Alcrona coated carbide	<b>2ALK-ST</b> = Alcrona coated cermet											
<b>3. Lead-in</b> E, M, K = Left hand helical flute A, F, G, L, N, T, V = Straight flute J, W, X, Y = Straight Flute with chipbreaker	<b>4. Diameter</b> XX.XXXX = Inch XXX.XXX = Metric	<b>5. Tolerance</b> 4 decimal places = inch tolerance 3 decimal places = mm tolerance  *The total tolerance capable is 0.0002" (0.005mm)										

### Reference Key

Symbol	Attribute
$D_1$	Reamer diameter
$D_2$	Shank diameter
$D_3$	Maximum conical ring diameter
$L_1$	Overall length
$L_2$	Length of cut
$L_5$	Maximum overhang
$L_7$	Shank length
$L_{15}$	Flute length

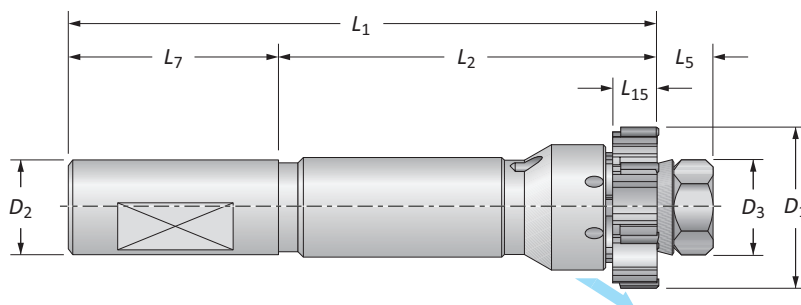

### Building Your Complete Tool

You will need both pieces to complete your ring style reamer assembly. There is a guide on the page where the rings are located. You must follow the guide to build the item number for the reamer ring that you need.

However, the complete mandrel item numbers are listed on their respective pages. You do not need to build the mandrel numbers.



1

Select Your Ring

2

Select Your Mandrel

## Cutting Rings

Imperial (inch) | Diameter Range: 0.6929" - 7.8976"

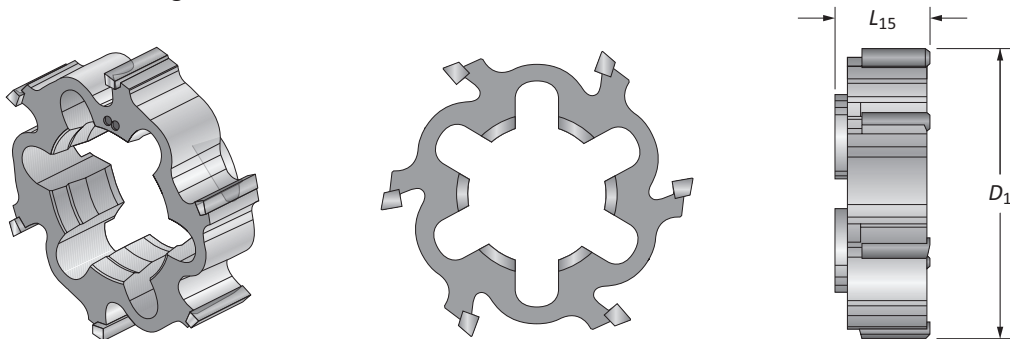

$D_1$ Range	$L_{15}$		Number of Teeth
	Imperial (inch)	Straight Flute	
0.6929 - 0.8503	0.433	–	6
0.8504 - 1.0078	0.472	–	6
1.0079 - 1.2834	0.551	–	6
1.2835 - 1.7952	0.630	0.630	6
1.7953 - 3.1338	0.728	0.728	6
3.1339 - 3.9605	0.728	0.728	8
3.9606 - 4.3542	0.728	0.728	10
4.3543 - 7.8976	0.728	0.728	12

# I 2ANC-STF-019686

Imperial Item

Cermet w/  
TiN Coating

F Lead-in

Diameter ( $D_1$ )

### Coating and Substrate Codes

Grade	Uncoated	TiN	TiCN	TiAlN	Alcrona
Carbide	2000-KT	2TIN-KT	2TIC-KT	2TIA-KT	2TLK-KK
Cermet	2AVC-ST	2ANC-ST	2ACC-ST	2AAC-ST	2ALK-SK

### Lead-in Recommendations

ISO Material	T	F	N	G	L	A	V
P			●	●		○	○
S	●			○			
M				●	○		
H			○	●			
K	○			●			○
N				●		●	○

● Best ○ Better ○ Good

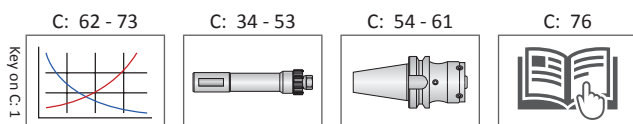



## Cutting Rings

Metric (mm) | Diameter Range: 17.600mm - 200.600mm

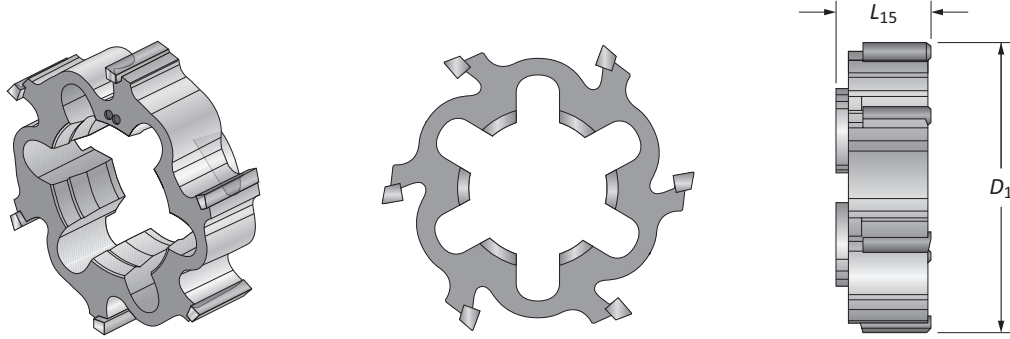

$D_1$ Range	$L_{15}$		Number of Teeth
	Straight Flute	Helical Flute	
Metric (mm)			
17.600 - 21.599	11.00	-	6
21.600 - 25.599	12.00	-	6
25.600 - 32.599	14.00	-	6
32.600 - 45.599	16.00	16.00	6
45.600 - 79.599	18.50	18.50	6
79.600 - 100.599	18.50	18.50	8
100.600 - 110.599	18.50	18.50	10
110.600 - 200.600	18.50	18.50	12

# 2ANC-STF-019686

Cermet w/  
TiN Coating

F Lead-in

Diameter ( $D_1$ )

### Coating and Substrate Codes

<b>Grade</b>	Uncoated	TiN	TiCN	TiAlN	Alcrona
<b>Carbide</b>	2000-KT	2TIN-KT	2TIC-KT	2TIA-KT	2TLK-KK
<b>Cermet</b>	2AVC-ST	2ANC-ST	2ACC-ST	2AAC-ST	2ALK-SK

### Lead-in Recommendations

ISO Material	T	F	N	G	L	A	V
P			●	●		◐	○
S	●			◐			
M				●	◐		
H			◐	●			
K	○			●			◐
N				●		●	◐

● Best ◐ Better ○ Good

Key on C-1

C: 62 - 73

C: 34 - 53

C: 54 - 61

C: 76

## Ring Style Mandrels

4550 Series | Short Length | Diameter Range: 0.6929" - 3.9602" (17.60mm - 100.59mm)

Series	4550
Shank Type	Cylindrical
Application	Through Holes
Coolant	Radial

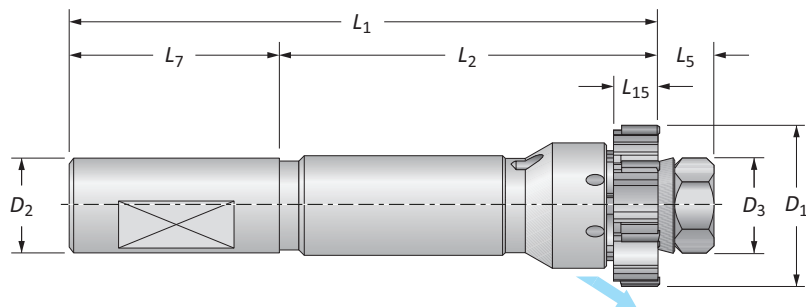

	Mandrel						Shank		Teeth	Part No. (Complete Mandrel*)	
	D <sub>1</sub> Range	D <sub>3</sub>	L <sub>5</sub>	L <sub>15</sub>	L <sub>2</sub>	L <sub>1</sub>	L <sub>7</sub>	D <sub>2</sub>		With Flat	Without Flat
i	0.6929 - 0.8503	0.472	0.433	0.433	3.189	5.591	1.969	0.750	6	94550-MC-010	94550A-MC-010
	0.8504 - 1.0078	0.472	0.433	0.472	3.189	5.591	1.969	0.750	6	94550-MC-020	94550A-MC-020
	1.0079 - 1.2834	0.614	0.433	0.551	4.016	6.417	1.969	0.750	6	94550-MC-030	94550A-MC-030
	1.2835 - 1.5983	0.866	0.551	0.630	4.016	6.772	2.205	1.000	6	94550-MC-040	94550A-MC-040
	1.5984 - 1.7952	1.000	0.591	0.630	4.016	6.811	2.205	1.000	6	94550-MC-050	94550A-MC-050
	1.7953 - 1.9527	1.181	0.807	0.728	4.134	7.303	2.362	1.250	6	94550-MC-060	94550A-MC-060
	1.9528 - 2.3857	1.181	0.807	0.728	4.134	7.303	2.362	1.250	6	94550-MC-070	94550A-MC-070
	2.3858 - 2.7794	1.575	0.965	0.728	4.134	7.461	2.362	1.250	6	94550-MC-080	94550A-MC-080
	2.7795 - 3.1338	1.575	0.965	0.728	4.134	7.461	2.362	1.250	6	94550-MC-090	94550A-MC-090
	3.1339 - 3.5668	2.205	1.122	0.728	4.134	8.012	2.756	1.500	8	94550-MC-100	94550A-MC-100
3.5669 - 3.9602	2.205	1.122	0.728	4.134	8.012	2.756	1.500	8	94550-MC-110	94550A-MC-110	
m	17.60 - 21.59	12	11	11	81	142	50	20	6	4550-MC-010	4550A-MC-010
	21.60 - 25.59	12	11	12	81	142	50	20	6	4550-MC-020	4550A-MC-020
	25.60 - 32.59	15.6	11	14	102	163	50	20	6	4550-MC-030	4550A-MC-030
	32.60 - 40.59	22	14	16	102	172	56	25	6	4550-MC-040	4550A-MC-040
	40.60 - 45.59	25.4	15	16	102	173	56	25	6	4550-MC-050	4550A-MC-050
	45.60 - 49.59	30	20.5	18.5	105	185.5	60	32	6	4550-MC-060	4550A-MC-060
	49.60 - 60.59	30	20.5	18.5	105	185.5	60	32	6	4550-MC-070	4550A-MC-070
	60.60 - 70.59	40	24.5	18.5	105	189.5	60	32	6	4550-MC-080	4550A-MC-080
	70.60 - 79.59	40	24.5	18.5	105	189.5	60	32	6	4550-MC-090	4550A-MC-090
	79.60 - 90.59	56	28.5	18.5	105	203.5	70	40	8	4550-MC-100	4550A-MC-100
90.60 - 100.59	56	28.5	18.5	105	203.5	70	40	8	4550-MC-110	4550A-MC-110	

\*Complete mandrel does not include cutting ring.

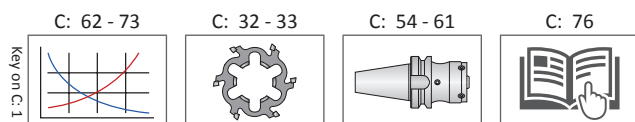
 i = Imperial (in)  
 m = Metric (mm)



## Ring Style Mandrels

4550 Series | Short Length | Spare Parts

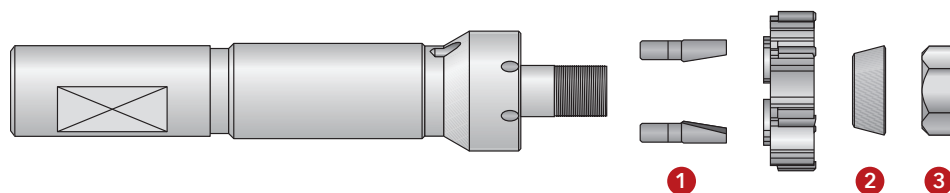

	Part No. (Complete Mandrel*)		Spare Parts				
	With Flat	Without Flat	1 Drive Pins	2 Number of Drive Pins	3 Conical Ring	4 Nut	5 Wrench Size (mm)
i	94550-MC-010	94550A-MC-010	2000-CO-010	3	2010-AC-010	2000-DA-010	10
	94550-MC-020	94550A-MC-020	2000-CO-020	3	2010-AC-010	2000-DA-010	10
	94550-MC-030	94550A-MC-030	2000-CO-030	3	2010-AC-020	2000-DA-020	13
	94550-MC-040	94550A-MC-040	2000-CO-040	2	2010-AC-030	2000-DA-060	19
	94550-MC-050	94550A-MC-050	2000-CO-060	2	2010-AC-040	2000-DA-090	22
	94550-MC-060	94550A-MC-060	2000-CO-060	2	2010-AC-050	2000-GH-880	30 ♦
	94550-MC-070	94550A-MC-070	2000-CO-070	2	2010-AC-050	2000-GH-880	30 ♦
	94550-MC-080	94550A-MC-080	2000-CO-080	2	2010-AC-060	2000-GH-900	40 ♦
	94550-MC-090	94550A-MC-090	2000-CO-090	2	2010-AC-060	2000-GH-900	40 ♦
	94550-MC-100	94550A-MC-100	2000-CO-090	2	2010-AC-070	2000-GH-920	56 ♦
	94550-MC-110	94550A-MC-110	2000-CO-090	2	2010-AC-070	2000-GH-920	56 ♦
ii	4550-MC-010	4550A-MC-010	2000-CO-010	3	2010-AC-010	2000-DA-010	10
	4550-MC-020	4550A-MC-020	2000-CO-020	3	2010-AC-010	2000-DA-010	10
	4550-MC-030	4550A-MC-030	2000-CO-030	3	2010-AC-020	2000-DA-020	13
	4550-MC-040	4550A-MC-040	2000-CO-040	2	2010-AC-030	2000-DA-060	19
	4550-MC-050	4550A-MC-050	2000-CO-060	2	2010-AC-040	2000-DA-090	22
	4550-MC-060	4550A-MC-060	2000-CO-060	2	2010-AC-050	2000-GH-880	30 ♦
	4550-MC-070	4550A-MC-070	2000-CO-070	2	2010-AC-050	2000-GH-880	30 ♦
	4550-MC-080	4550A-MC-080	2000-CO-080	2	2010-AC-060	2000-GH-900	40 ♦
	4550-MC-090	4550A-MC-090	2000-CO-090	2	2010-AC-060	2000-GH-900	40 ♦
	4550-MC-100	4550A-MC-100	2000-CO-090	2	2010-AC-070	2000-GH-920	56 ♦
	4550-MC-110	4550A-MC-110	2000-CO-090	2	2010-AC-070	2000-GH-920	56 ♦

\*Complete mandrel does not include cutting ring.

♦ Spanner wrench

i = Imperial (in)  
ii = Metric (mm)

## Ring Style Mandrels

4555 Series | Short Length | Diameter Range: 0.6929" - 3.9602" (17.60mm - 100.59mm)

Series	4555
Shank Type	Cylindrical
Application	Blind Holes
Coolant	Radial

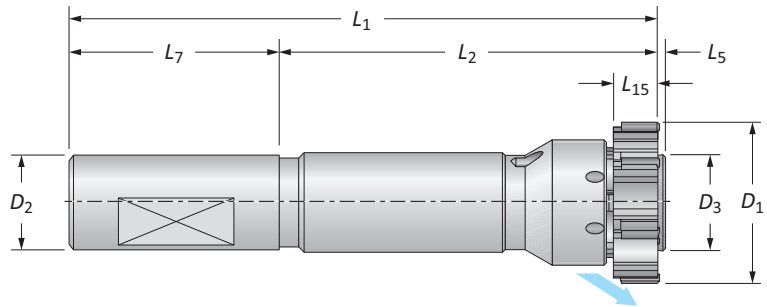

	Mandrel						Shank		Teeth	Part No. (Complete Mandrel*)	
	D <sub>1</sub> Range	D <sub>3</sub>	L <sub>5</sub>	L <sub>15</sub>	L <sub>2</sub>	L <sub>1</sub>	L <sub>7</sub>	D <sub>2</sub>		With Flat	Without Flat
	0.6929 - 0.8503	0.441	0.039	0.433	3.189	5.197	1.969	0.750	6	94555-MC-010	94555A-MC-010
	0.8504 - 1.0078	0.441	0.039	0.472	3.189	5.197	1.969	0.750	6	94555-MC-020	94555A-MC-020
	1.0079 - 1.1653	0.594	0.039	0.551	4.016	6.024	1.969	0.750	6	94555-MC-030	94555A-MC-030
	1.1654 - 1.2834	0.594	0.039	0.551	4.016	6.024	1.969	0.750	6	94555-MC-035	94555A-MC-035
	1.2835 - 1.4408	0.799	0.039	0.630	4.016	6.260	2.205	1.000	6	94555-MC-040	94555A-MC-040
	1.4409 - 1.5983	0.799	0.039	0.630	4.016	6.260	2.205	1.000	6	94555-MC-045	94555A-MC-045
	1.5984 - 1.7952	0.949	0.039	0.630	4.016	6.260	2.205	1.000	6	94555-MC-050	94555A-MC-050
<b>i</b>	1.7953 - 1.9527	1.098	0.059	0.728	4.134	6.555	2.362	1.250	6	94555-MC-060	94555A-MC-060
	1.9528 - 2.1889	1.098	0.059	0.728	4.134	6.555	2.362	1.250	6	94555-MC-070	94555A-MC-070
	2.1890 - 2.3857	1.098	0.059	0.728	4.134	6.555	2.362	1.250	6	94555-MC-075	94555A-MC-075
	2.3858 - 2.5826	1.461	0.059	0.728	4.134	6.555	2.362	1.250	6	94555-MC-080	94555A-MC-080
	2.5827 - 2.7794	1.461	0.059	0.728	4.134	6.555	2.362	1.250	6	94555-MC-085	94555A-MC-085
	2.7795 - 3.1338	1.461	0.059	0.728	4.134	6.555	2.362	1.250	6	94555-MC-090	94555A-MC-090
	3.1339 - 3.5668	2.091	0.059	0.728	4.134	6.949	2.756	1.500	8	94555-MC-100	94555A-MC-100
	3.5669 - 3.9602	2.091	0.059	0.728	4.134	6.949	2.756	1.500	8	94555-MC-110	94555A-MC-110
<b>m</b>	17.60 - 21.59	11.2	1	11	81	132	50	20	6	4555-MC-010	4555A-MC-010
	21.60 - 25.59	11.2	1	12	81	132	50	20	6	4555-MC-020	4555A-MC-020
	25.60 - 29.59	15.1	1	14	102	153	50	20	6	4555-MC-030	4555A-MC-030
	29.60 - 32.59	15.1	1	14	102	153	50	20	6	4555-MC-035	4555A-MC-035
	32.60 - 36.59	20.3	1	16	102	159	56	25	6	4555-MC-040	4555A-MC-040
	36.60 - 40.59	20.3	1	16	102	159	56	25	6	4555-MC-045	4555A-MC-045
	40.60 - 45.59	24.1	1	16	102	159	56	25	6	4555-MC-050	4555A-MC-050
	45.60 - 49.59	27.9	1.5	18.5	105	166.5	60	32	6	4555-MC-060	4555A-MC-060
	49.60 - 55.59	27.9	1.5	18.5	105	166.5	60	32	6	4555-MC-070	4555A-MC-070
	55.60 - 60.59	27.9	1.5	18.5	105	166.5	60	32	6	4555-MC-075	4555A-MC-075
	60.60 - 65.59	37.1	1.5	18.5	105	166.5	60	32	6	4555-MC-080	4555A-MC-080
	65.60 - 70.59	37.1	1.5	18.5	105	166.5	60	32	6	4555-MC-085	4555A-MC-085
	70.60 - 79.59	37.1	1.5	18.5	105	166.5	60	32	6	4555-MC-090	4555A-MC-090
	79.60 - 90.59	53.1	1.5	18.5	105	176.5	70	40	8	4555-MC-100	4555A-MC-100
	90.60 - 100.59	53.1	1.5	18.5	105	176.5	70	40	8	4555-MC-110	4555A-MC-110

\*Complete mandrel does not include cutting ring.

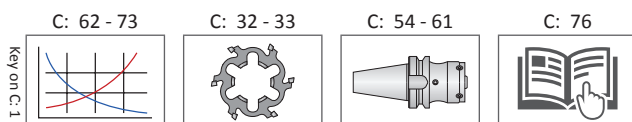

**i** = Imperial (in)  
**m** = Metric (mm)





## Ring Style Mandrels

4555 Series | Short Length | Spare Parts

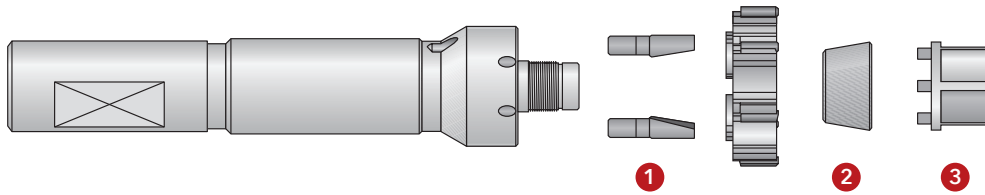

Part No. (Complete Mandrel*)		Spare Parts							Wrench Size (mm)
With Flat	Without Flat	1 Drive Pins	Number of Drive Pins	2 Conical Ring	Conical Ring (2nd Expansion)	Conical Ring (3rd Expansion)	3 Adjusting Key		
94555-MC-010	94555A-MC-010	2000-CO-010	3	4001-AC-115	4001-AC-215	-	4001-CH-015	10	
94555-MC-020	94555A-MC-020	2000-CO-020	3	4001-AC-115	4001-AC-215	-	4001-CH-015	10	
94555-MC-030	94555A-MC-030	2000-CO-030	3	4001-AC-125	4001-AC-225	4001-AC-325	4001-CH-025	13	
94555-MC-035	94555A-MC-035	2000-CO-040	2	4001-AC-125	4001-AC-225	4001-AC-325	4001-CH-025	13	
94555-MC-040	94555A-MC-040	2000-CO-040	2	4001-AC-135	4001-AC-235	4001-AC-335	4001-CH-035	18	
94555-MC-045	94555A-MC-045	2000-CO-050	2	4001-AC-135	4001-AC-235	4001-AC-335	4001-CH-035	18	
<b>i</b> 94555-MC-050	94555A-MC-050	2000-CO-060	2	4001-AC-145	4001-AC-245	4001-AC-345	4001-CH-045	22	
94555-MC-060	94555A-MC-060	2000-CO-060	2	4001-AC-155	4001-AC-255	4001-AC-355	4001-CH-055	26	
94555-MC-070	94555A-MC-070	2000-CO-070	2	4001-AC-155	4001-AC-255	4001-AC-355	4001-CH-055	26	
94555-MC-075	94555A-MC-075	2000-CO-080	2	4001-AC-155	4001-AC-255	4001-AC-355	4001-CH-055	26	
94555-MC-080	94555A-MC-080	2000-CO-080	2	4001-AC-165	4001-AC-265	4001-AC-365	4001-CH-065	34	
94555-MC-085	94555A-MC-085	2000-CO-090	2	4001-AC-165	4001-AC-265	4001-AC-365	4001-CH-065	34	
94555-MC-090	94555A-MC-090	2000-CO-090	2	4001-AC-165	4001-AC-265	4001-AC-365	4001-CH-065	34	
94555-MC-100	94555A-MC-100	2000-CO-090	2	4001-AC-185	4001-AC-285	4001-AC-385	4001-CH-085	46	
94555-MC-110	94555A-MC-110	2000-CO-090	2	4001-AC-185	4001-AC-285	4001-AC-385	4001-CH-085	46	
<hr/>									
<b>ii</b> 4555-MC-010	4555A-MC-010	2000-CO-010	3	4001-AC-115	4001-AC-215	-	4001-CH-015	10	
4555-MC-020	4555A-MC-020	2000-CO-020	3	4001-AC-115	4001-AC-215	-	4001-CH-015	10	
4555-MC-030	4555A-MC-030	2000-CO-030	3	4001-AC-125	4001-AC-225	4001-AC-325	4001-CH-025	13	
4555-MC-035	4555A-MC-035	2000-CO-040	2	4001-AC-125	4001-AC-225	4001-AC-325	4001-CH-025	13	
4555-MC-040	4555A-MC-040	2000-CO-040	2	4001-AC-135	4001-AC-235	4001-AC-335	4001-CH-035	18	
4555-MC-045	4555A-MC-045	2000-CO-050	2	4001-AC-135	4001-AC-235	4001-AC-335	4001-CH-035	18	
4555-MC-050	4555A-MC-050	2000-CO-060	2	4001-AC-145	4001-AC-245	4001-AC-345	4001-CH-045	22	
<b>ii</b> 4555-MC-060	4555A-MC-060	2000-CO-060	2	4001-AC-155	4001-AC-255	4001-AC-355	4001-CH-055	26	
4555-MC-070	4555A-MC-070	2000-CO-070	2	4001-AC-155	4001-AC-255	4001-AC-355	4001-CH-055	26	
4555-MC-075	4555A-MC-075	2000-CO-080	2	4001-AC-155	4001-AC-255	4001-AC-355	4001-CH-055	26	
4555-MC-080	4555A-MC-080	2000-CO-080	2	4001-AC-165	4001-AC-265	4001-AC-365	4001-CH-065	34	
4555-MC-085	4555A-MC-085	2000-CO-090	2	4001-AC-165	4001-AC-265	4001-AC-365	4001-CH-065	34	
4555-MC-090	4555A-MC-090	2000-CO-090	2	4001-AC-165	4001-AC-265	4001-AC-365	4001-CH-065	34	
4555-MC-100	4555A-MC-100	2000-CO-090	2	4001-AC-185	4001-AC-285	4001-AC-385	4001-CH-085	46	
4555-MC-110	4555A-MC-110	2000-CO-090	2	4001-AC-185	4001-AC-285	4001-AC-385	4001-CH-085	46	

\*Complete mandrel does not include cutting ring.

**i** = Imperial (in)  
**ii** = Metric (mm)

## Ring Style Mandrels

4500 Series | Long Length | Diameter Range: 0.6929" - 3.9602" (17.60mm - 100.59mm)

Series	4500
Shank Type	Cylindrical
Application	Through Holes
Coolant	Radial

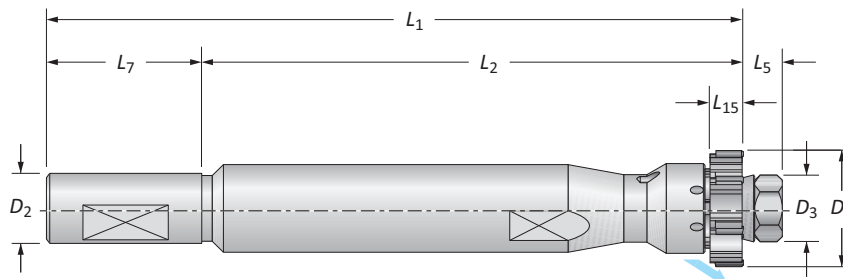

	Mandrel						Shank		Teeth	Part No. (Complete Mandrel*)	
	D <sub>1</sub> Range	D <sub>3</sub>	L <sub>5</sub>	L <sub>15</sub>	L <sub>2</sub>	L <sub>1</sub>	L <sub>7</sub>	D <sub>2</sub>		With Flat	Without Flat
i	0.6929 - 0.8503	0.472	0.433	0.433	4.764	7.165	1.969	0.750	6	94500-MC-010	94500A-MC-010
	0.8504 - 1.0078	0.472	0.433	0.472	4.764	7.165	1.969	0.750	6	94500-MC-020	94500A-MC-020
	1.0079 - 1.2834	0.614	0.433	0.551	6.024	8.425	1.969	0.750	6	94500-MC-030	94500A-MC-030
	1.2835 - 1.5983	0.866	0.551	0.630	7.047	9.803	2.205	1.000	6	94500-MC-040	94500A-MC-040
	1.5984 - 1.7952	0.866	0.551	0.630	7.047	9.803	2.205	1.000	6	94500-MC-050	94500A-MC-050
	1.7953 - 1.9527	1.000	0.591	0.630	7.913	10.709	2.205	1.000	6	94500-MC-060	94500A-MC-060
	1.9528 - 2.3857	1.181	0.807	0.728	8.425	11.594	2.362	1.250	6	94500-MC-070	94500A-MC-070
	2.3858 - 2.7794	1.575	0.965	0.728	9.331	12.657	2.362	1.250	6	94500-MC-080	94500A-MC-080
	2.7795 - 3.1338	1.575	0.965	0.728	9.331	12.657	2.362	1.250	6	94500-MC-090	94500A-MC-090
	3.1339 - 3.5668	2.205	1.122	0.728	9.646	13.524	2.756	1.500	6	94500-MC-100	94500A-MC-100
3.5669 - 3.9602	2.205	1.122	0.728	9.646	13.524	2.756	1.500	8	94500-MC-110	94500A-MC-110	
m	17.60 - 21.59	12	11	11	121	182	50	20	6	4500-MC-010	4500A-MC-010
	21.60 - 25.59	12	11	12	121	182	50	20	6	4500-MC-020	4500A-MC-020
	25.60 - 32.59	15.6	11	14	153	214	50	20	6	4500-MC-030	4500A-MC-030
	32.60 - 40.59	22	14	16	179	249	56	25	6	4500-MC-040	4500A-MC-040
	40.60 - 45.59	25.4	15	16	201	272	56	25	6	4500-MC-050	4500A-MC-050
	45.60 - 49.59	30	20.5	18.5	214	294.5	60	32	6	4500-MC-060	4500A-MC-060
	49.60 - 60.59	30	20.5	18.5	214	294.5	60	32	6	4500-MC-070	4500A-MC-070
	60.60 - 70.59	40	24.5	18.5	237	321.5	60	32	6	4500-MC-080	4500A-MC-080
	70.60 - 79.59	40	24.5	18.5	237	321.5	60	32	6	4500-MC-090	4500A-MC-090
	79.60 - 90.59	56	28.5	18.5	245	343.5	70	40	6	4500-MC-100	4500A-MC-100
90.60 - 100.59	56	28.5	18.5	245	343.5	70	40	8	4500-MC-110	4500A-MC-110	

\*Complete mandrel does not include cutting ring.

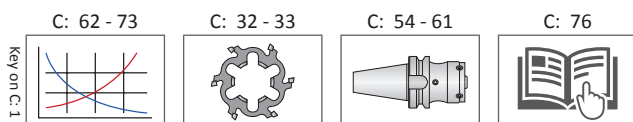
 i = Imperial (in)  
 m = Metric (mm)



## Ring Style Mandrels

4500 Series | Long Length | Spare Parts

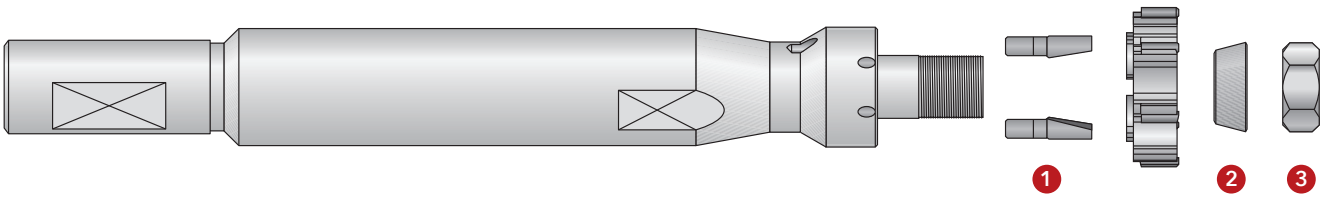

	Part No. (Complete Mandrel*)		Spare Parts				
	With Flat	Without Flat	1		2	3	
			Drive Pins	Number of Drive Pins	Conical Ring	Nut	Wrench Size (mm)
i	94500-MC-010	94500A-MC-010	2000-CO-010	3	2010-AC-010	2000-DA-010	10
	94500-MC-020	94500A-MC-020	2000-CO-020	3	2010-AC-010	2000-DA-010	10
	94500-MC-030	94500A-MC-030	2000-CO-030	3	2010-AC-020	2000-DA-020	13
	94500-MC-040	94500A-MC-040	2000-CO-040	2	2010-AC-030	2000-DA-060	19
	94500-MC-050	94500A-MC-050	2000-CO-060	2	2010-AC-040	2000-DA-090	22
	94500-MC-060	94500A-MC-060	2000-CO-060	2	2010-AC-050	2000-GH-880	30 ♦
	94500-MC-070	94500A-MC-070	2000-CO-070	2	2010-AC-050	2000-GH-880	30 ♦
	94500-MC-080	94500A-MC-080	2000-CO-080	2	2010-AC-060	2000-GH-900	40 ♦
	94500-MC-090	94500A-MC-090	2000-CO-090	2	2010-AC-060	2000-GH-900	40 ♦
	94500-MC-100	94500A-MC-100	2000-CO-090	2	2010-AC-070	2000-GH-920	56 ♦
	94500-MC-110	94500A-MC-110	2000-CO-090	2	2010-AC-070	2000-GH-920	56 ♦
ii	4500-MC-010	4500A-MC-010	2000-CO-010	3	2010-AC-010	2000-DA-010	10
	4500-MC-020	4500A-MC-020	2000-CO-020	3	2010-AC-010	2000-DA-010	10
	4500-MC-030	4500A-MC-030	2000-CO-030	3	2010-AC-020	2000-DA-020	13
	4500-MC-040	4500A-MC-040	2000-CO-040	2	2010-AC-030	2000-DA-060	19
	4500-MC-050	4500A-MC-050	2000-CO-060	2	2010-AC-040	2000-DA-090	22
	4500-MC-060	4500A-MC-060	2000-CO-060	2	2010-AC-050	2000-GH-880	30 ♦
	4500-MC-070	4500A-MC-070	2000-CO-070	2	2010-AC-050	2000-GH-880	30 ♦
	4500-MC-080	4500A-MC-080	2000-CO-080	2	2010-AC-060	2000-GH-900	40 ♦
	4500-MC-090	4500A-MC-090	2000-CO-090	2	2010-AC-060	2000-GH-900	40 ♦
	4500-MC-100	4500A-MC-100	2000-CO-090	2	2010-AC-070	2000-GH-920	56 ♦
	4500-MC-110	4500A-MC-110	2000-CO-090	2	2010-AC-070	2000-GH-920	56 ♦

\*Complete mandrel does not include cutting ring.

♦ Spanner wrench

i = Imperial (in)  
ii = Metric (mm)

## Ring Style Mandrels

4505 Series | Long Length | Diameter Range: 0.6929" - 3.9602" (17.60mm - 100.59mm)

Series	4505
Shank Type	Cylindrical
Application	Blind Holes
Coolant	Radial

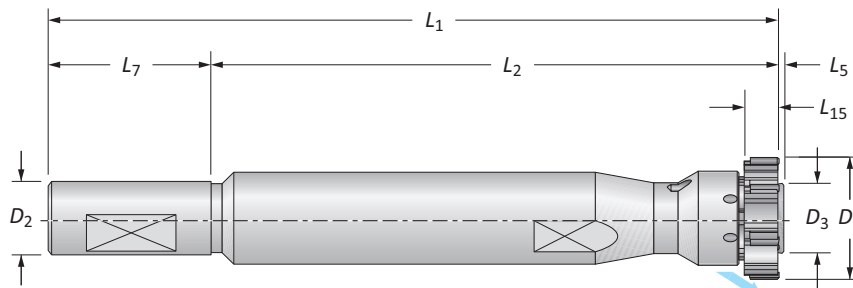

D <sub>1</sub> Range	Mandrel					Shank			Teeth	Part No. (Complete Mandrel*)	
	D <sub>3</sub>	L <sub>5</sub>	L <sub>15</sub>	L <sub>2</sub>	L <sub>1</sub>	L <sub>7</sub>	D <sub>2</sub>	With Flat		Without Flat	
0.6929 - 0.8503	0.441	0.039	0.433	4.764	6.772	1.969	0.750	6	94505-MC-010	94505A-MC-010	
0.8504 - 1.0078	0.441	0.039	0.472	4.764	6.772	1.969	0.750	6	94505-MC-020	94505A-MC-020	
1.0079 - 1.1653	0.594	0.039	0.551	6.024	8.031	1.969	0.750	6	94505-MC-030	94505A-MC-030	
1.1654 - 1.2834	0.594	0.039	0.551	6.024	8.031	1.969	0.750	6	94505-MC-035	94505A-MC-035	
1.2835 - 1.4408	0.799	0.039	0.630	7.047	9.291	2.205	1.000	6	94505-MC-040	94505A-MC-040	
1.4409 - 1.5983	0.799	0.039	0.630	7.047	9.291	2.205	1.000	6	94505-MC-045	94505A-MC-045	
1.5984 - 1.7952	0.949	0.039	0.630	7.913	10.157	2.205	1.000	6	94505-MC-050	94505A-MC-050	
1.7953 - 1.9527	1.098	0.059	0.728	8.425	10.846	2.362	1.250	6	94505-MC-060	94505A-MC-060	
1.9528 - 2.1889	1.098	0.059	0.728	8.425	10.846	2.362	1.250	6	94505-MC-070	94505A-MC-070	
2.1890 - 2.3857	1.098	0.059	0.728	8.425	10.846	2.362	1.250	6	94505-MC-075	94505A-MC-075	
2.3858 - 2.5826	1.461	0.059	0.728	9.331	11.752	2.362	1.250	6	94505-MC-080	94505A-MC-080	
2.5827 - 2.7794	1.461	0.059	0.728	9.331	11.752	2.362	1.250	6	94505-MC-085	94505A-MC-085	
2.7795 - 3.1338	1.461	0.059	0.728	9.331	11.752	2.362	1.250	6	94505-MC-090	94505A-MC-090	
3.1339 - 3.5668	2.091	0.059	0.728	9.646	12.461	2.756	1.500	8	94505-MC-100	94505A-MC-100	
3.5669 - 3.9602	2.091	0.059	0.728	9.646	12.461	2.756	1.500	8	94505-MC-110	94505A-MC-110	
17.60 - 21.59	11.2	1	11	121	172	50	20	6	4505-MC-010	4505A-MC-010	
21.60 - 25.59	11.2	1	12	121	172	50	20	6	4505-MC-020	4505A-MC-020	
25.60 - 29.59	15.1	1	14	153	204	50	20	6	4505-MC-030	4505A-MC-030	
29.60 - 32.59	15.1	1	14	153	204	50	20	6	4505-MC-035	4505A-MC-035	
32.60 - 36.59	20.3	1	16	179	236	56	25	6	4505-MC-040	4505A-MC-040	
36.60 - 40.59	20.3	1	16	179	236	56	25	6	4505-MC-045	4505A-MC-045	
40.60 - 45.59	24.1	1	16	201	258	56	25	6	4505-MC-050	4505A-MC-050	
45.60 - 49.59	27.9	1.5	18.5	214	275.5	60	32	6	4505-MC-060	4505A-MC-060	
49.60 - 55.59	27.9	1.5	18.5	214	275.5	60	32	6	4505-MC-070	4505A-MC-070	
55.60 - 60.59	27.9	1.5	18.5	214	275.5	60	32	6	4505-MC-075	4505A-MC-075	
60.60 - 65.59	37.1	1.5	18.5	237	298.5	60	32	6	4505-MC-080	4505A-MC-080	
65.60 - 70.59	37.1	1.5	18.5	237	298.5	60	32	6	4505-MC-085	4505A-MC-085	
70.60 - 79.59	37.1	1.5	18.5	237	298.5	60	32	6	4505-MC-090	4505A-MC-090	
79.60 - 90.59	53.1	1.5	18.5	245	316.5	70	40	8	4505-MC-100	4505A-MC-100	
90.60 - 100.59	53.1	1.5	18.5	245	316.5	70	40	8	4505-MC-110	4505A-MC-110	

\*Complete mandrel does not include cutting ring.

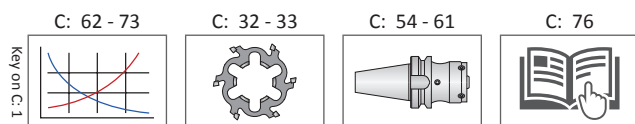

**i** = Imperial (in)  
**m** = Metric (mm)

## Ring Style Mandrels

4505 Series | Long Length | Spare Parts

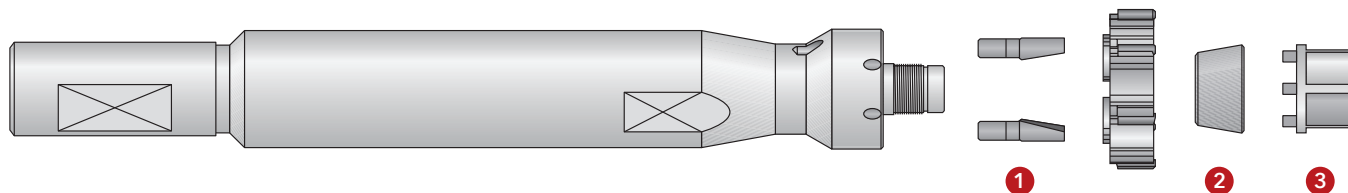

Part No. (Complete Mandrel*)		Spare Parts							Wrench Size (mm)
With Flat	Without Flat	1		2			3		
		Drive Pins	Number of Drive Pins	Conical Ring	Conical Ring (2nd Expansion)	Conical Ring (3rd Expansion)	Adjusting Key		
<b>i</b> 94505-MC-010	94505A-MC-010	2000-CO-010	3	4001-AC-115	4001-AC-215	–	4001-CH-015	10	
94505-MC-020	94505A-MC-020	2000-CO-020	3	4001-AC-115	4001-AC-215	–	4001-CH-015	10	
94505-MC-030	94505A-MC-030	2000-CO-030	3	4001-AC-125	4001-AC-225	4001-AC-325	4001-CH-025	13	
94505-MC-035	94505A-MC-035	2000-CO-040	2	4001-AC-125	4001-AC-225	4001-AC-325	4001-CH-025	13	
94505-MC-040	94505A-MC-040	2000-CO-040	2	4001-AC-135	4001-AC-235	4001-AC-335	4001-CH-035	18	
94505-MC-045	94505A-MC-045	2000-CO-050	2	4001-AC-135	4001-AC-235	4001-AC-335	4001-CH-035	18	
94505-MC-050	94505A-MC-050	2000-CO-060	2	4001-AC-145	4001-AC-245	4001-AC-345	4001-CH-045	22	
94505-MC-060	94505A-MC-060	2000-CO-060	2	4001-AC-155	4001-AC-255	4001-AC-355	4001-CH-055	26	
94505-MC-070	94505A-MC-070	2000-CO-070	2	4001-AC-155	4001-AC-255	4001-AC-355	4001-CH-055	26	
94505-MC-075	94505A-MC-075	2000-CO-080	2	4001-AC-155	4001-AC-255	4001-AC-355	4001-CH-055	26	
94505-MC-080	94505A-MC-080	2000-CO-080	2	4001-AC-165	4001-AC-265	4001-AC-365	4001-CH-065	34	
94505-MC-085	94505A-MC-085	2000-CO-090	2	4001-AC-165	4001-AC-265	4001-AC-365	4001-CH-065	34	
94505-MC-090	94505A-MC-090	2000-CO-090	2	4001-AC-165	4001-AC-265	4001-AC-365	4001-CH-065	34	
94505-MC-100	94505A-MC-100	2000-CO-090	2	4001-AC-185	4001-AC-285	4001-AC-385	4001-CH-085	46	
94505-MC-110	94505A-MC-110	2000-CO-090	2	4001-AC-185	4001-AC-285	4001-AC-385	4001-CH-085	46	
<b>ii</b> 4505-MC-010	4505A-MC-010	2000-CO-010	3	4001-AC-115	4001-AC-215	–	4001-CH-015	10	
4505-MC-020	4505A-MC-020	2000-CO-020	3	4001-AC-115	4001-AC-215	–	4001-CH-015	10	
4505-MC-030	4505A-MC-030	2000-CO-030	3	4001-AC-125	4001-AC-225	4001-AC-325	4001-CH-025	13	
4505-MC-035	4505A-MC-035	2000-CO-040	2	4001-AC-125	4001-AC-225	4001-AC-325	4001-CH-025	13	
4505-MC-040	4505A-MC-040	2000-CO-040	2	4001-AC-135	4001-AC-235	4001-AC-335	4001-CH-035	18	
4505-MC-045	4505A-MC-045	2000-CO-050	2	4001-AC-135	4001-AC-235	4001-AC-335	4001-CH-035	18	
4505-MC-050	4505A-MC-050	2000-CO-060	2	4001-AC-145	4001-AC-245	4001-AC-345	4001-CH-045	22	
4505-MC-060	4505A-MC-060	2000-CO-060	2	4001-AC-155	4001-AC-255	4001-AC-355	4001-CH-055	26	
4505-MC-070	4505A-MC-070	2000-CO-070	2	4001-AC-155	4001-AC-255	4001-AC-355	4001-CH-055	26	
4505-MC-075	4505A-MC-075	2000-CO-080	2	4001-AC-155	4001-AC-255	4001-AC-355	4001-CH-055	26	
4505-MC-080	4505A-MC-080	2000-CO-080	2	4001-AC-165	4001-AC-265	4001-AC-365	4001-CH-065	34	
4505-MC-085	4505A-MC-085	2000-CO-090	2	4001-AC-165	4001-AC-265	4001-AC-365	4001-CH-065	34	
4505-MC-090	4505A-MC-090	2000-CO-090	2	4001-AC-165	4001-AC-265	4001-AC-365	4001-CH-065	34	
4505-MC-100	4505A-MC-100	2000-CO-090	2	4001-AC-185	4001-AC-285	4001-AC-385	4001-CH-085	46	
4505-MC-110	4505A-MC-110	2000-CO-090	2	4001-AC-185	4001-AC-285	4001-AC-385	4001-CH-085	46	

\*Complete mandrel does not include cutting ring.

**i** = Imperial (in)  
**ii** = Metric (mm)

## Ring Style Mandrels

4330 Series | Short Length | Diameter Range: 0.6929" - 3.9602 (17.60mm - 100.59mm)

Series	4330
Shank Type	Modular
Application	Through Holes
Coolant	Radial

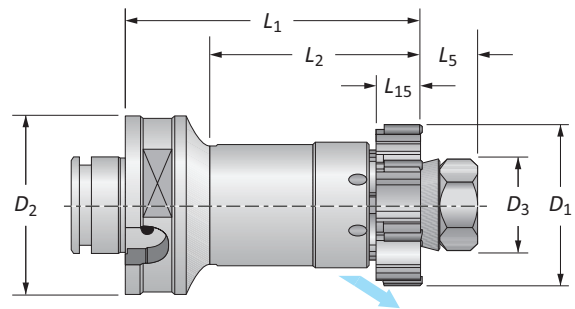

$D_1$ Range		Mandrel					Shank	Teeth	Part No. (Complete Mandrel*)
Imperial (inch)	Metric (mm)	$D_3$	$L_5$	$L_{15}$	$L_2$	$L_1$	$D_2$		
0.6929 - 0.8503	17.60 - 21.59	12	11	11	55	75	50	6	<b>4330-MC-010</b>
0.8504 - 1.0078	21.60 - 25.59	12	11	12	55	75	50	6	<b>4330-MC-020</b>
1.0079 - 1.2834	25.60 - 32.59	15.6	11	14	60	80	50	6	<b>4330-MC-030</b>
1.2835 - 1.5983	32.60 - 40.59	22	14	16	60	80	50	6	<b>4330-MC-040</b>
1.5984 - 1.7952	40.60 - 45.59	25.4	15	16	60	80	50	6	<b>4330-MC-050</b>
<b>m</b> 1.7953 - 1.9527	45.60 - 49.59	30	20.5	18.5	60	80	50	6	<b>4330-MC-060</b>
1.9528 - 2.3857	49.60 - 60.59	30	20.5	18.5	60	80	50	6	<b>4330-MC-070</b>
2.3858 - 2.7794	60.60 - 70.59	40	24.5	18.5	65	90	63	6	<b>4330-MC-080</b>
2.7795 - 3.1338	70.60 - 79.59	40	24.5	18.5	65	90	63	6	<b>4330-MC-090</b>
3.1339 - 3.5668	79.60 - 90.59	56	28.5	18.5	65	90	63	8	<b>4330-MC-100</b>
3.5669 - 3.9602	90.60 - 100.59	56	28.5	18.5	65	90	63	8	<b>4330-MC-110</b>

\*Complete mandrel does not include cutting ring.

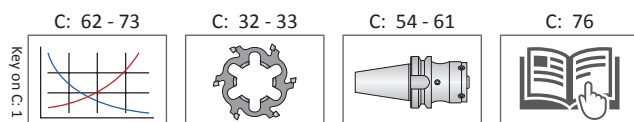

**i** = Imperial (in)  
**m** = Metric (mm)



## Ring Style Mandrels

4330 Series | Short Length | Spare Parts

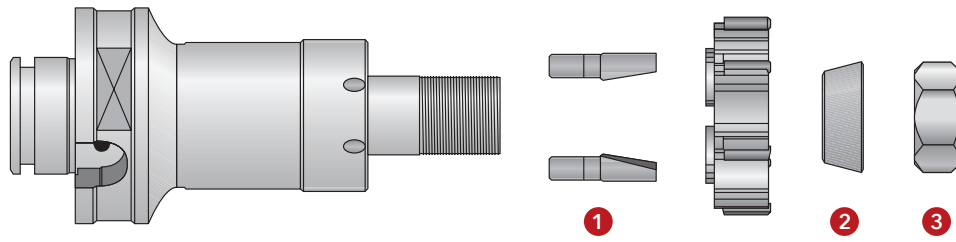

Part No. (Complete Mandrel*)	Spare Parts					Wrench Size (mm)
	1 Drive Pins	Number of Drive Pins	2 Conical Ring	3 Nut		
<b>4330-MC-010</b>	2000-CO-010	3	2010-AC-010	2000-DA-010	10	
<b>4330-MC-020</b>	2000-CO-020	3	2010-AC-010	2000-DA-010	10	
<b>4330-MC-030</b>	2000-CO-030	3	2010-AC-020	2000-DA-020	13	
<b>4330-MC-040</b>	2000-CO-040	2	2010-AC-030	2000-DA-060	19	
<b>4330-MC-050</b>	2000-CO-060	2	2010-AC-040	2000-DA-090	22	
<b>4330-MC-060</b>	2000-CO-060	2	2010-AC-050	2000-GH-880	30 ♦	
<b>4330-MC-070</b>	2000-CO-070	2	2010-AC-050	2000-GH-880	30 ♦	
<b>4330-MC-080</b>	2000-CO-080	2	2010-AC-060	2000-GH-900	40 ♦	
<b>4330-MC-090</b>	2000-CO-090	2	2010-AC-060	2000-GH-900	40 ♦	
<b>4330-MC-100</b>	2000-CO-090	2	2010-AC-070	2000-GH-920	56 ♦	
<b>4330-MC-110</b>	2000-CO-090	2	2010-AC-070	2000-GH-920	56 ♦	

\*Complete mandrel does not include cutting ring.

♦ Spanner wrench

Ⓜ

Ⓜ = Imperial (in)  
Ⓜ = Metric (mm)

## Ring Style Mandrels

4335 Series | Short Length | Diameter Range: 0.6929" - 3.9602 (17.60mm - 100.59mm)

Series	4335
Shank Type	Modular
Application	Blind Holes
Coolant	Radial

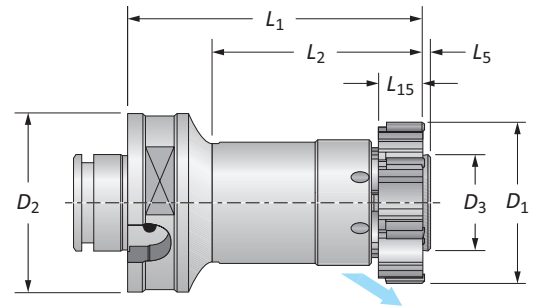

$D_1$ Range		Mandrel					Shank		Teeth	Part No. (Complete Mandrel*)
Imperial (inch)	Metric (mm)	$D_3$	$L_5$	$L_{15}$	$L_2$	$L_1$	$D_2$			
0.6929 - 0.8503	17.60 - 21.59	11.2	1	11	55	75	50	6	<b>4335-MC-010</b>	
0.8504 - 1.0078	21.60 - 25.59	11.2	1	12	55	75	50	6	<b>4335-MC-020</b>	
1.0079 - 1.1653	25.60 - 29.59	15.1	1	14	60	80	50	6	<b>4335-MC-030</b>	
1.1654 - 1.2834	29.60 - 32.59	15.1	1	14	60	80	50	6	<b>4335-MC-035</b>	
1.2835 - 1.4408	32.60 - 36.59	20.3	1	16	60	80	50	6	<b>4335-MC-040</b>	
1.4409 - 1.5983	36.60 - 40.59	20.3	1	16	60	80	50	6	<b>4335-MC-045</b>	
1.5984 - 1.7952	40.60 - 45.59	24.1	1	16	60	80	50	6	<b>4335-MC-050</b>	
<b>m</b> 1.7953 - 1.9527	45.60 - 49.59	27.9	1.5	18.5	60	80	50	6	<b>4335-MC-060</b>	
1.9528 - 2.1889	49.60 - 55.59	27.9	1.5	18.5	60	80	50	6	<b>4335-MC-070</b>	
2.1890 - 2.3857	55.60 - 60.59	27.9	1.5	18.5	60	80	50	6	<b>4335-MC-075</b>	
2.3858 - 2.5826	60.60 - 65.59	37.1	1.5	18.5	65	90	63	6	<b>4335-MC-080</b>	
2.5827 - 2.7794	65.60 - 70.59	37.1	1.5	18.5	65	90	63	6	<b>4335-MC-085</b>	
2.7795 - 3.1338	70.60 - 79.59	37.1	1.5	18.5	65	90	63	6	<b>4335-MC-090</b>	
3.1339 - 3.5668	79.60 - 90.59	53.1	1.5	18.5	65	90	63	8	<b>4335-MC-100</b>	
3.5669 - 3.9602	90.60 - 100.59	53.1	1.5	18.5	65	90	63	8	<b>4335-MC-110</b>	

\*Complete mandrel does not include cutting ring.

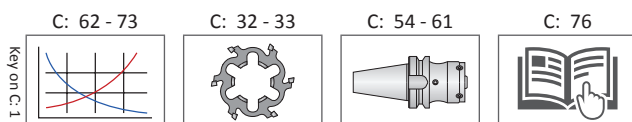

**i** = Imperial (in)  
**m** = Metric (mm)





## Ring Style Mandrels

4335 Series | Short Length | Spare Parts

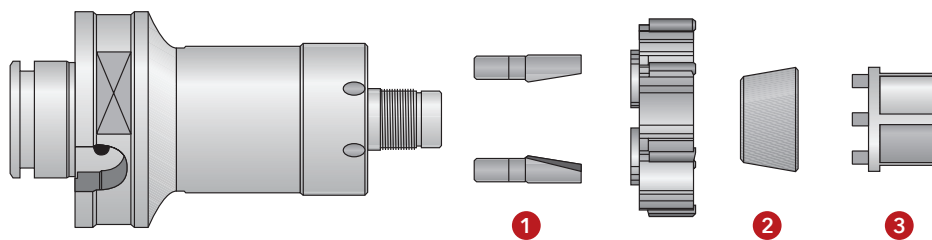

Part No. (Complete Mandrel*)	Spare Parts							Wrench Size (mm)
	1 Drive Pins	Number of Drive Pins	2 Conical Ring	Conical Ring (2nd Expansion)	Conical Ring (3rd Expansion)	3 Adjusting Key		
4335-MC-010	2000-CO-010	3	4001-AC-115	4001-AC-215	-	4001-CH-015	10	
4335-MC-020	2000-CO-020	3	4001-AC-115	4001-AC-215	-	4001-CH-015	10	
4335-MC-030	2000-CO-030	3	4001-AC-125	4001-AC-225	4001-AC-325	4001-CH-025	13	
4335-MC-035	2000-CO-040	2	4001-AC-125	4001-AC-225	4001-AC-325	4001-CH-025	13	
4335-MC-040	2000-CO-040	2	4001-AC-135	4001-AC-235	4001-AC-335	4001-CH-035	18	
4335-MC-045	2000-CO-050	2	4001-AC-135	4001-AC-235	4001-AC-335	4001-CH-035	18	
4335-MC-050	2000-CO-060	2	4001-AC-145	4001-AC-245	4001-AC-345	4001-CH-045	22	
4335-MC-060	2000-CO-060	2	4001-AC-155	4001-AC-255	4001-AC-355	4001-CH-055	26	
4335-MC-070	2000-CO-070	2	4001-AC-155	4001-AC-255	4001-AC-355	4001-CH-055	26	
4335-MC-075	2000-CO-080	2	4001-AC-155	4001-AC-255	4001-AC-355	4001-CH-055	26	
4335-MC-080	2000-CO-080	2	4001-AC-165	4001-AC-265	4001-AC-365	4001-CH-065	34	
4335-MC-085	2000-CO-090	2	4001-AC-165	4001-AC-265	4001-AC-365	4001-CH-065	34	
4335-MC-090	2000-CO-090	2	4001-AC-165	4001-AC-265	4001-AC-365	4001-CH-065	34	
4335-MC-100	2000-CO-090	2	4001-AC-185	4001-AC-285	4001-AC-385	4001-CH-085	46	
4335-MC-110	2000-CO-090	2	4001-AC-185	4001-AC-285	4001-AC-385	4001-CH-085	46	

\*Complete mandrel does not include cutting ring.

Ⓜ

Ⓜ = Imperial (in)  
Ⓜ = Metric (mm)

## Ring Style Mandrels

4350 Series | Standard Length | Diameter Range: 0.6929" - 7.8972 (17.60mm - 200.59mm)

Series	4350
Shank Type	Modular
Application	Through Holes
Coolant	Radial

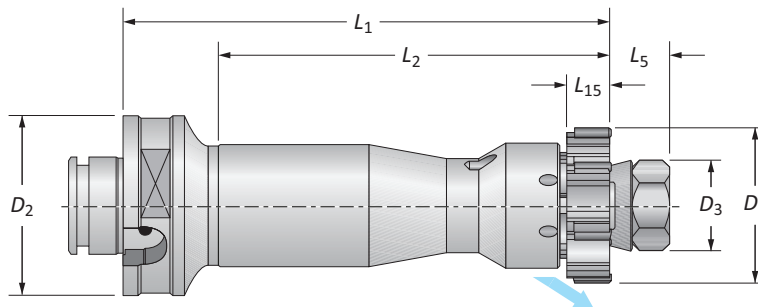

$D_1$ Range		Mandrel					Shank		Teeth	Part No. (Complete Mandrel*)
Imperial (inch)	Metric (mm)	$D_3$	$L_5$	$L_{15}$	$L_2$	$L_1$	$D_2$			
0.6929 - 0.8503	17.60 - 21.59	12	11	11	81	116	50	6	<b>4350-MC-010</b>	
0.8504 - 1.0078	21.60 - 25.59	12	11	12	81	116	50	6	<b>4350-MC-020</b>	
1.0079 - 1.2834	25.60 - 32.59	15.6	11	14	102	137	50	6	<b>4350-MC-030</b>	
1.2835 - 1.5983	32.60 - 40.59	22	14	16	102	137	50	6	<b>4350-MC-040</b>	
1.5984 - 1.7952	40.60 - 45.59	25.4	15	16	102	137	50	6	<b>4350-MC-050</b>	
1.7953 - 1.9527	45.60 - 49.59	30	20.5	18.5	105	140	50	6	<b>4350-MC-060</b>	
1.9528 - 2.3857	49.60 - 60.59	30	20.5	18.5	105	140	50	6	<b>4350-MC-070</b>	
2.3858 - 2.7794	60.60 - 70.59	40	24.5	18.5	105	140	63	6	<b>4350-MC-080</b>	
2.7795 - 3.1338	70.60 - 79.59	40	24.5	18.5	105	140	63	6	<b>4350-MC-090</b>	
3.1339 - 3.5668	79.60 - 90.59	56	28.5	18.5	105	140	63	8	<b>4350-MC-100</b>	
3.5669 - 3.9602	90.60 - 100.59	56	28.5	18.5	105	140	63	8	<b>4350-MC-110</b>	

\*Complete mandrel does not include cutting ring.

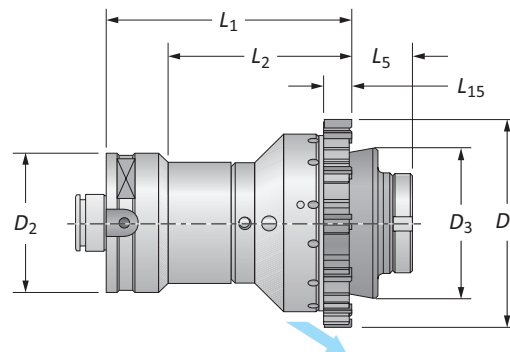

$D_1$ Range		Mandrel					Shank		Teeth	Part No. (Complete Mandrel*)
Imperial (inch)	Metric (mm)	$D_3$	$L_5$	$L_{15}$	$L_2$	$L_1$	$D_2$			
3.9603 - 4.3539	100.60 - 110.59	73.8	35.5	18.5	-	140	80	10	<b>4350-MC-120</b>	
4.3540 - 4.5508	110.60 - 115.59	80.8	35.5	18.5	-	140	80	12	<b>4350-MC-130</b>	
4.5509 - 4.7476	115.60 - 120.59	86.8	35.5	18.5	-	140	80	12	<b>4350-MC-140</b>	
4.7477 - 4.9445	120.60 - 125.59	86.8	35.5	18.5	-	140	80	12	<b>4350-MC-150</b>	
4.9446 - 5.2201	125.60 - 132.59	90.8	35.5	18.5	-	140	80	12	<b>4350-MC-160</b>	
5.2202 - 5.4957	132.60 - 139.59	90.8	35.5	18.5	-	140	80	12	<b>4350-MC-170</b>	
5.4958 - 5.7319	139.60 - 145.59	102.8	35.5	18.5	-	140	80	12	<b>4350-MC-180</b>	
5.7320 - 6.1256	145.60 - 155.59	107.8	35.5	18.5	-	140	80	12	<b>4350-MC-190</b>	
6.1257 - 6.5193	155.60 - 165.59	107.8	48.5	18.5	-	140	80	12	<b>4350-MC-200</b>	
6.5194 - 6.9130	165.60 - 175.59	117.8	48.5	18.5	-	140	80	12	<b>4350-MC-210</b>	
6.9131 - 7.3067	175.60 - 185.59	127.8	48.5	18.5	-	140	80	12	<b>4350-MC-220</b>	
7.3068 - 7.7004	185.60 - 195.59	137.8	48.5	18.5	-	140	80	12	<b>4350-MC-230</b>	
7.7005 - 7.8972	195.60 - 200.59	145.8	48.5	18.5	-	140	80	12	<b>4350-MC-240</b>	

\*Complete mandrel does not include cutting ring.

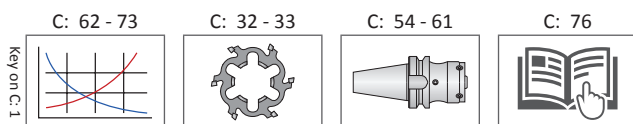

**i** = Imperial (in)  
**m** = Metric (mm)



## Ring Style Mandrels

4350 Series | Standard Length | Spare Parts

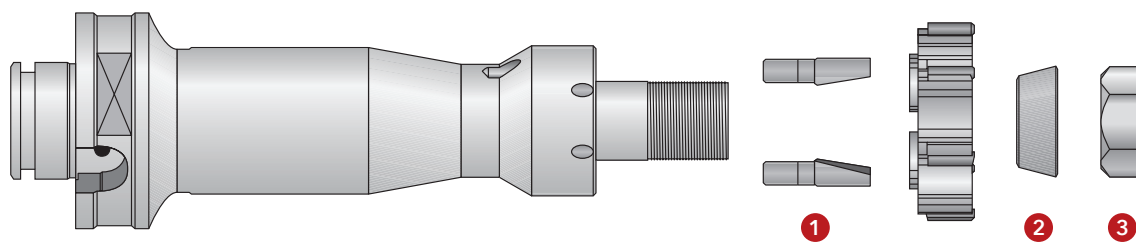

Part No. (Complete Mandrel*)	Spare Parts					Wrench Size (mm)
	1 Drive Pins	Number of Drive Pins	2 Conical Ring	3 Nut		
4350-MC-010	2000-CO-010	3	2010-AC-010	2000-DA-010	10	
4350-MC-020	2000-CO-020	3	2010-AC-010	2000-DA-010	10	
4350-MC-030	2000-CO-030	3	2010-AC-020	2000-DA-020	13	
4350-MC-040	2000-CO-040	2	2010-AC-030	2000-DA-060	19	
4350-MC-050	2000-CO-060	2	2010-AC-040	2000-DA-090	22	
4350-MC-060	2000-CO-060	2	2010-AC-050	2000-GH-880	30 ♦	
4350-MC-070	2000-CO-070	2	2010-AC-050	2000-GH-880	30 ♦	
4350-MC-080	2000-CO-080	2	2010-AC-060	2000-GH-900	40 ♦	
4350-MC-090	2000-CO-090	2	2010-AC-060	2000-GH-900	40 ♦	
4350-MC-100	2000-CO-090	2	2010-AC-070	2000-GH-920	56 ♦	
4350-MC-110	2000-CO-090	2	2010-AC-070	2000-GH-920	56 ♦	

\*Complete mandrel does not include cutting ring.

♦ Spanner wrench

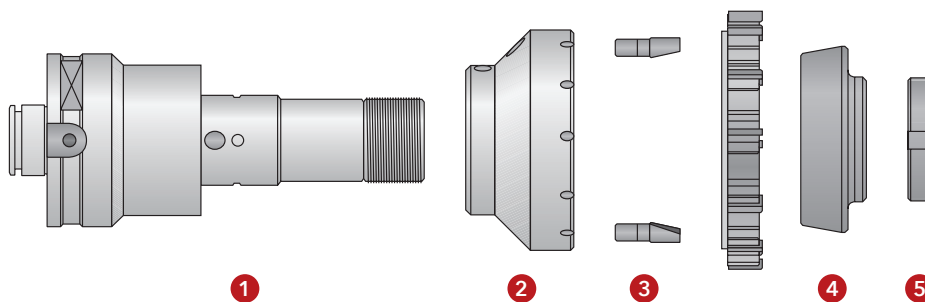

Part No. (Complete Mandrel*)	Spare Parts						Wrench Size (mm)
	1 Mandrel	2 Flange	3 Drive Pins	Number of Drive Pins	4 Conical Ring	5 Nut	
4350-MC-120	4350-MA-120	4355-FL-035	2000-CO-090	2	2060-BU-010	2000-GH-095	58 ♦
4350-MC-130	4350-MA-120	4355-FL-045	2000-CO-090	2	2060-BU-020	2000-GH-095	58 ♦
4350-MC-140	4350-MA-120	4355-FL-055	2000-CO-090	2	2060-BU-030	2000-GH-095	58 ♦
4350-MC-150	4350-MA-120	4355-FL-065	2000-CO-090	2	2060-BU-030	2000-GH-095	58 ♦
4350-MC-160	4350-MA-120	4355-FL-075	2000-CO-100	2	2060-BU-040	2000-GH-095	58 ♦
4350-MC-170	4350-MA-120	4355-FL-085	2000-CO-100	2	2060-BU-040	2000-GH-095	58 ♦
4350-MC-180	4350-MA-120	4355-FL-095	2000-CO-100	2	2060-BU-050	2000-GH-095	58 ♦
4350-MC-190	4350-MA-120	4355-FL-105	2000-CO-110	2	2060-BU-060	2000-GH-095	58 ♦
4350-MC-200	4350-MA-200	4355-FL-115	2000-CO-110	2	2060-BU-070	2000-GH-120	90 ♦
4350-MC-210	4350-MA-200	4355-FL-125	2000-CO-110	2	2060-BU-080	2000-GH-120	90 ♦
4350-MC-220	4350-MA-200	4355-FL-135	2000-CO-120	2	2060-BU-090	2000-GH-120	90 ♦
4350-MC-230	4350-MA-200	4355-FL-145	2000-CO-120	2	2060-BU-100	2000-GH-120	90 ♦
4350-MC-240	4350-MA-200	4355-FL-155	2000-CO-120	2	2060-BU-110	2000-GH-120	90 ♦

\*Complete mandrel does not include cutting ring.

♦ Spanner wrench

1 = Imperial (in)  
M = Metric (mm)

## Ring Style Mandrels

4355 Series | Standard Length | Diameter Range: 0.6929" - 7.8972 (17.60mm - 200.59mm)

Series	4355
Shank Type	Modular
Application	Blind Holes
Coolant	Radial

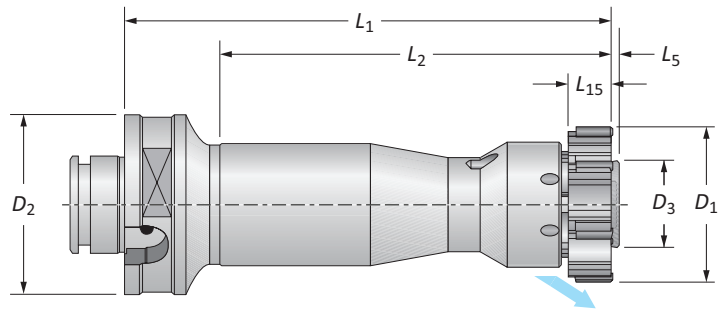

D <sub>1</sub> Range		Mandrel					Shank		Teeth	Part No. (Complete Mandrel*)
Imperial (inch)	Metric (mm)	D <sub>3</sub>	L <sub>5</sub>	L <sub>15</sub>	L <sub>2</sub>	L <sub>1</sub>	D <sub>2</sub>			
0.6929 - 0.8503	17.60 - 21.59	11.2	1	11	81	116	50	6	<b>4355-MC-010</b>	
0.8504 - 1.0078	21.60 - 25.59	11.2	1	12	81	116	50	6	<b>4355-MC-020</b>	
1.0079 - 1.1653	25.60 - 29.59	15.1	1	14	102	137	50	6	<b>4355-MC-030</b>	
1.1654 - 1.2834	29.60 - 32.59	15.1	1	14	102	137	50	6	<b>4355-MC-035</b>	
1.2835 - 1.4408	32.60 - 36.59	20.3	1	16	102	137	50	6	<b>4355-MC-040</b>	
1.4409 - 1.5983	36.60 - 40.59	20.3	1	16	102	137	50	6	<b>4355-MC-045</b>	
1.5984 - 1.7952	40.60 - 45.59	24.1	1	16	102	137	50	6	<b>4355-MC-050</b>	
<b>m</b> 1.7953 - 1.9527	45.60 - 49.59	27.9	1.5	18.5	105	140	50	6	<b>4355-MC-060</b>	
1.9528 - 2.1889	49.60 - 55.59	27.9	1.5	18.5	105	140	50	6	<b>4355-MC-070</b>	
2.1890 - 2.3857	55.60 - 60.59	27.9	1.5	18.5	105	140	50	6	<b>4355-MC-075</b>	
2.3858 - 2.5826	60.60 - 65.59	37.1	1.5	18.5	105	140	63	6	<b>4355-MC-080</b>	
2.5827 - 2.7794	65.60 - 70.59	37.1	1.5	18.5	105	140	63	6	<b>4355-MC-085</b>	
2.7795 - 3.1338	70.60 - 79.59	37.1	1.5	18.5	105	140	63	6	<b>4355-MC-090</b>	
3.1339 - 3.5668	79.60 - 90.59	53.1	1.5	18.5	105	140	63	8	<b>4355-MC-100</b>	
3.5669 - 3.9602	90.60 - 100.59	53.1	1.5	18.5	105	140	63	8	<b>4355-MC-110</b>	

\*Complete mandrel does not include cutting ring.

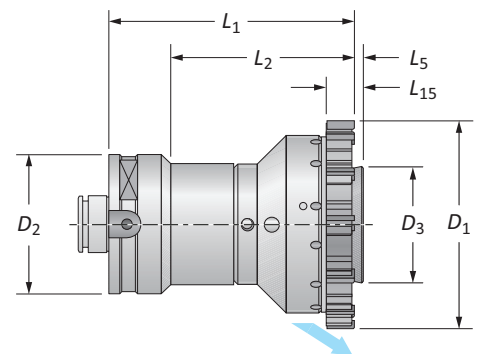

D <sub>1</sub> Range		Mandrel					Shank		Teeth	Part No. (Complete Mandrel*)
Imperial (inch)	Metric (mm)	D <sub>3</sub>	L <sub>5</sub>	L <sub>15</sub>	L <sub>2</sub>	L <sub>1</sub>	D <sub>2</sub>			
3.9603 - 4.3539	100.60 - 110.59	70.3	1.5	18.5	-	140	80	10	<b>4355-MC-120</b>	
4.3540 - 4.5508	110.60 - 115.59	76.3	1.5	18.5	-	140	80	12	<b>4355-MC-130</b>	
4.5509 - 4.7476	115.60 - 120.59	83.3	1.5	18.5	-	140	80	12	<b>4355-MC-140</b>	
4.7477 - 4.9445	120.60 - 125.59	87.3	1.5	18.5	-	140	80	12	<b>4355-MC-150</b>	
4.9446 - 5.2201	125.60 - 132.59	87.3	1.5	18.5	-	140	80	12	<b>4355-MC-160</b>	
5.2202 - 5.4957	132.60 - 139.59	87.3	1.5	18.5	-	140	80	12	<b>4355-MC-170</b>	
<b>m</b> 5.4958 - 5.7319	139.60 - 145.59	99.3	1.5	18.5	-	140	80	12	<b>4355-MC-180</b>	
5.7320 - 6.1256	145.60 - 155.59	104.3	1.5	18.5	-	140	80	12	<b>4355-MC-190</b>	
6.1257 - 6.5193	155.60 - 165.59	104.3	1.5	18.5	-	140	80	12	<b>4355-MC-200</b>	
6.5194 - 6.9130	165.60 - 175.59	114.3	1.5	18.5	-	140	80	12	<b>4355-MC-210</b>	
6.9131 - 7.3067	175.60 - 185.59	124.3	1.5	18.5	-	140	80	12	<b>4355-MC-220</b>	
7.3068 - 7.7004	185.60 - 195.59	134.3	1.5	18.5	-	140	80	12	<b>4355-MC-230</b>	
7.7005 - 7.8972	195.60 - 200.59	142.3	1.5	18.5	-	140	80	12	<b>4355-MC-240</b>	

\*Complete mandrel does not include cutting ring.

C: 62 - 73

C: 32 - 33

C: 54 - 61

C: 76

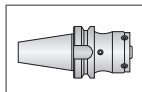
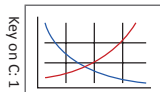
 ⓘ = Imperial (in)  
 ⓘ = Metric (mm)



## Ring Style Mandrels

4355 Series | Standard Length | Spare Parts

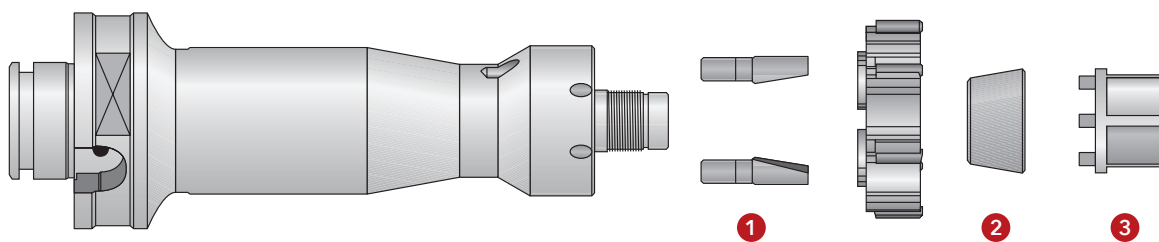

Part No. (Complete Mandrel*)	Spare Parts							Wrench Size (mm)
	1 Drive Pins	Number of Drive Pins	2 Conical Ring	Conical Ring (2nd Expansion)	Conical Ring (3rd Expansion)	3 Adjusting Key		
4355-MC-010	2000-CO-010	3	4001-AC-115	4001-AC-215	-	4001-CH-015	10	
4355-MC-020	2000-CO-020	3	4001-AC-115	4001-AC-215	-	4001-CH-015	10	
4355-MC-030	2000-CO-030	3	4001-AC-125	4001-AC-225	4001-AC-325	4001-CH-025	13	
4355-MC-035	2000-CO-040	2	4001-AC-125	4001-AC-225	4001-AC-325	4001-CH-025	13	
4355-MC-040	2000-CO-040	2	4001-AC-135	4001-AC-235	4001-AC-335	4001-CH-035	18	
4355-MC-045	2000-CO-050	2	4001-AC-135	4001-AC-235	4001-AC-335	4001-CH-035	18	
4355-MC-050	2000-CO-060	2	4001-AC-145	4001-AC-245	4001-AC-345	4001-CH-045	22	
4355-MC-060	2000-CO-060	2	4001-AC-155	4001-AC-255	4001-AC-355	4001-CH-055	26	
4355-MC-070	2000-CO-070	2	4001-AC-155	4001-AC-255	4001-AC-355	4001-CH-055	26	
4355-MC-075	2000-CO-080	2	4001-AC-155	4001-AC-255	4001-AC-355	4001-CH-055	26	
4355-MC-080	2000-CO-080	2	4001-AC-165	4001-AC-265	4001-AC-365	4001-CH-065	34	
4355-MC-085	2000-CO-090	2	4001-AC-165	4001-AC-265	4001-AC-365	4001-CH-065	34	
4355-MC-090	2000-CO-090	2	4001-AC-165	4001-AC-265	4001-AC-365	4001-CH-065	34	
4355-MC-100	2000-CO-090	2	4001-AC-185	4001-AC-285	4001-AC-385	4001-CH-085	46	
4355-MC-110	2000-CO-090	2	4001-AC-185	4001-AC-285	4001-AC-385	4001-CH-085	46	

\*Complete mandrel does not include cutting ring.

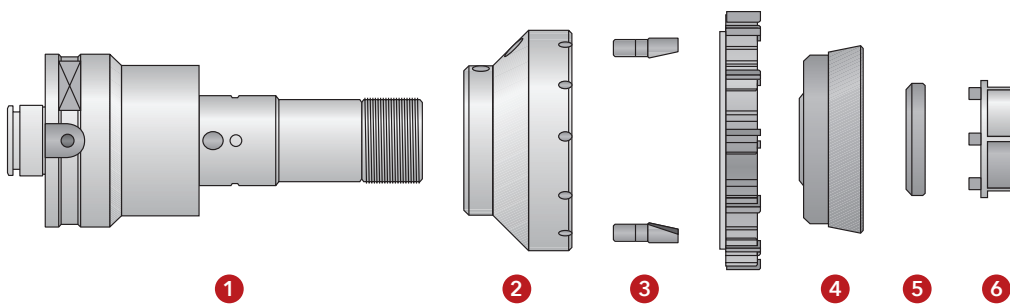

Part No. (Complete Mandrel*)	Spare Parts							Wrench Size (mm)
	1 Mandrel	2 Flange	3 Drive Pins	Number of Drive Pins	4 Conical Ring	5 Nut	6 Adjusting Key	
4355-MC-120	4355-MA-120	4355-FL-035	2000-CO-090	2	4001-AC-116	4001-GH-035	4001-CH-135	46
4355-MC-130	4355-MA-120	4355-FL-045	2000-CO-090	2	4001-AC-126	4001-GH-035	4001-CH-135	46
4355-MC-140	4355-MA-120	4355-FL-055	2000-CO-090	2	4001-AC-136	4001-GH-035	4001-CH-135	46
4355-MC-150	4355-MA-120	4355-FL-065	2000-CO-090	2	4001-AC-136	4001-GH-035	4001-CH-135	46
4355-MC-160	4355-MA-120	4355-FL-075	2000-CO-100	2	4001-AC-146	4001-GH-035	4001-CH-135	46
4355-MC-170	4355-MA-120	4355-FL-085	2000-CO-100	2	4001-AC-146	4001-GH-035	4001-CH-135	46
4355-MC-180	4355-MA-120	4355-FL-095	2000-CO-100	2	4001-AC-156	4001-GH-035	4001-CH-135	46
4355-MC-190	4355-MA-120	4355-FL-105	2000-CO-110	2	4001-AC-166	4001-GH-035	4001-CH-135	46
4355-MC-200	4355-MA-200	4355-FL-115	2000-CO-110	2	4001-AC-176	4001-GH-115	4001-CH-115	46
4355-MC-210	4355-MA-200	4355-FL-125	2000-CO-110	2	4001-AC-186	4001-GH-115	4001-CH-115	46
4355-MC-220	4355-MA-200	4355-FL-135	2000-CO-120	2	4001-AC-196	4001-GH-115	4001-CH-115	46
4355-MC-230	4355-MA-200	4355-FL-145	2000-CO-120	2	4001-AC-117	4001-GH-115	4001-CH-115	46
4355-MC-240	4355-MA-200	4355-FL-155	2000-CO-120	2	4001-AC-127	4001-GH-115	4001-CH-115	46

\*Complete mandrel does not include cutting ring.

ⓘ = Imperial (in)  
Ⓜ = Metric (mm)

## Ring Style Mandrels

4300 Series | Long Length | Diameter Range: 0.6929" - 3.9602 (17.60mm - 100.59mm)

Series	4300
Shank Type	Modular
Application	Through Holes
Coolant	Radial

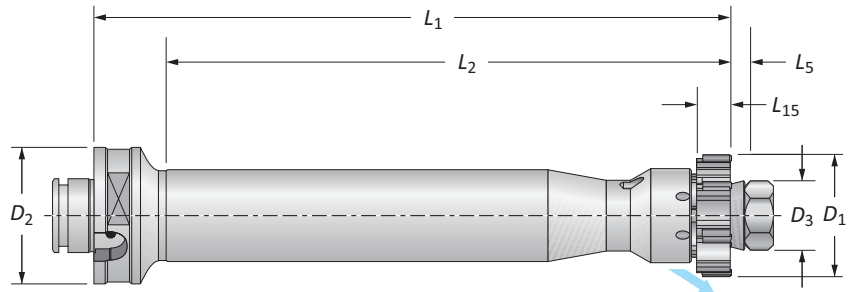

D <sub>1</sub> Range		Mandrel							Teeth	Part No. (Complete Mandrel*)
Imperial (inch)	Metric (mm)	D <sub>3</sub>	L <sub>5</sub>	L <sub>15</sub>	L <sub>2</sub>	L <sub>1</sub>	D <sub>2</sub>			
0.6929 - 0.8503	17.60 - 21.59	12	11	11	121	156	50	6	<b>4300-MC-010</b>	
0.8504 - 1.0078	21.60 - 25.59	12	11	12	121	156	50	6	<b>4300-MC-020</b>	
1.0079 - 1.2834	25.60 - 32.59	15.6	11	14	153	188	50	6	<b>4300-MC-030</b>	
1.2835 - 1.5983	32.60 - 40.59	22	14	16	179	214	50	6	<b>4300-MC-040</b>	
1.5984 - 1.7952	40.60 - 45.59	25.4	15	16	201	236	50	6	<b>4300-MC-050</b>	
<b>m</b> 1.7953 - 1.9527	45.60 - 49.59	30	20.5	18.5	214	249	50	6	<b>4300-MC-060</b>	
1.9528 - 2.3857	49.60 - 60.59	30	20.5	18.5	214	249	50	6	<b>4300-MC-070</b>	
2.3858 - 2.7794	60.60 - 70.59	40	24.5	18.5	237	272	63	6	<b>4300-MC-080</b>	
2.7795 - 3.1338	70.60 - 79.59	40	24.5	18.5	237	272	63	6	<b>4300-MC-090</b>	
3.1339 - 3.5668	79.60 - 90.59	56	28.5	18.5	245	280	63	8	<b>4300-MC-100</b>	
3.5669 - 3.9602	90.60 - 100.59	56	28.5	18.5	245	280	63	8	<b>4300-MC-110</b>	

\*Complete mandrel does not include cutting ring.

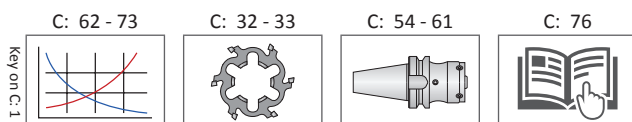

**i** = Imperial (in)  
**m** = Metric (mm)



## Ring Style Mandrels

4300 Series | Long Length | Spare Parts

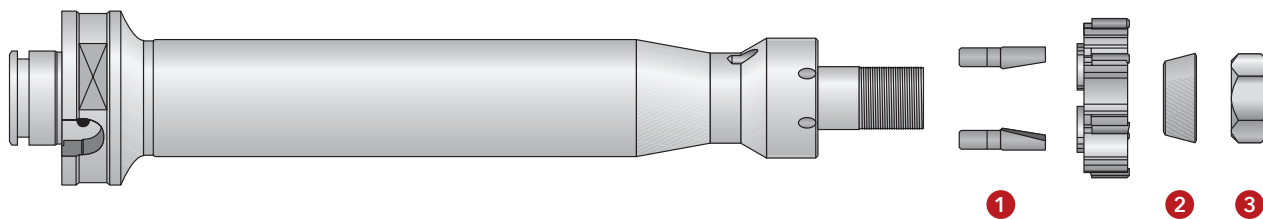

Part No. (Complete Mandrel*)	Spare Parts				
	1 Drive Pins	Number of Drive Pins	2 Conical Ring	3 Nut	Wrench Size (mm)
<b>4300-MC-010</b>	2000-CO-010	3	2010-AC-010	2000-DA-010	10
<b>4300-MC-020</b>	2000-CO-020	3	2010-AC-010	2000-DA-010	10
<b>4300-MC-030</b>	2000-CO-030	3	2010-AC-020	2000-DA-020	13
<b>4300-MC-040</b>	2000-CO-040	2	2010-AC-030	2000-DA-060	19
<b>4300-MC-050</b>	2000-CO-060	2	2010-AC-040	2000-DA-090	22
<b>4300-MC-060</b>	2000-CO-060	2	2010-AC-050	2000-GH-880	30
<b>4300-MC-070</b>	2000-CO-070	2	2010-AC-050	2000-GH-880	30
<b>4300-MC-080</b>	2000-CO-080	2	2010-AC-060	2000-GH-900	40
<b>4300-MC-090</b>	2000-CO-090	2	2010-AC-060	2000-GH-900	40
<b>4300-MC-100</b>	2000-CO-090	2	2010-AC-070	2000-GH-920	56
<b>4300-MC-110</b>	2000-CO-090	2	2010-AC-070	2000-GH-920	56

\*Complete mandrel does not include cutting ring.

Ⓜ

Ⓜ = Imperial (in)  
Ⓜ = Metric (mm)

## Ring Style Mandrels

4305 Series | Long Length | Diameter Range: 0.6929" - 3.9602 (17.60mm - 100.59mm)

Series	4305
Shank Type	Modular
Application	Blind Holes
Coolant	Radial

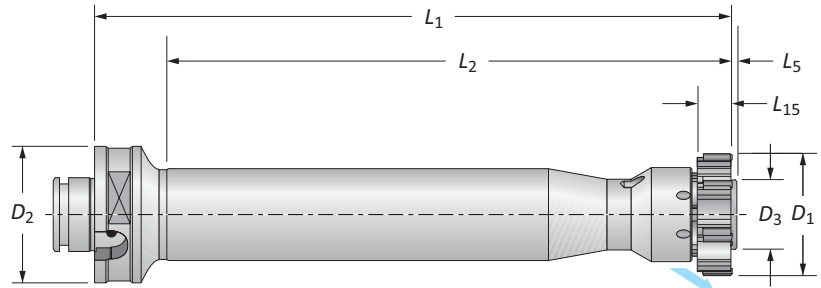

D <sub>1</sub> Range		Mandrel					Teeth	Part No. (Complete Mandrel*)
Imperial (inch)	Metric (mm)	L <sub>5</sub>	L <sub>15</sub>	L <sub>2</sub>	L <sub>1</sub>	D <sub>2</sub>		
0.6929 - 0.8503	17.60 - 21.59	1	11	121	156	50	6	<b>4305-MC-010</b>
0.8504 - 1.0078	21.60 - 25.59	1	12	121	156	50	6	<b>4305-MC-020</b>
1.0079 - 1.1653	25.60 - 29.59	1	14	153	188	50	6	<b>4305-MC-030</b>
1.1654 - 1.2834	29.60 - 32.59	1	14	153	188	50	6	<b>4305-MC-035</b>
1.2835 - 1.4408	32.60 - 36.59	1	16	179	214	50	6	<b>4305-MC-040</b>
1.4409 - 1.5983	36.60 - 40.59	1	16	179	214	50	6	<b>4305-MC-045</b>
1.5984 - 1.7952	40.60 - 45.59	1	16	201	236	50	6	<b>4305-MC-050</b>
<b>m</b> 1.7953 - 1.9527	45.60 - 49.59	1.5	18.5	214	249	50	6	<b>4305-MC-060</b>
1.9528 - 2.1889	49.60 - 55.59	1.5	18.5	214	249	50	6	<b>4305-MC-070</b>
2.1890 - 2.3857	55.60 - 60.59	1.5	18.5	214	249	50	6	<b>4305-MC-075</b>
2.3858 - 2.5826	60.60 - 65.59	1	18.5	237	272	63	6	<b>4305-MC-080</b>
2.5827 - 2.7794	65.60 - 70.59	1	18.5	237	272	63	6	<b>4305-MC-085</b>
2.7795 - 3.1338	70.60 - 79.59	1	18.5	237	272	63	6	<b>4305-MC-090</b>
3.1339 - 3.5668	79.60 - 90.59	1.5	18.5	245	280	63	8	<b>4305-MC-100</b>
3.5669 - 3.9602	90.60 - 100.59	1.5	18.5	245	280	63	8	<b>4305-MC-110</b>

\*Complete mandrel does not include cutting ring.

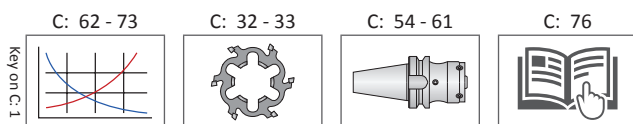

**i** = Imperial (in)  
**m** = Metric (mm)





## Ring Style Mandrels

4305 Series | Long Length | Spare Parts

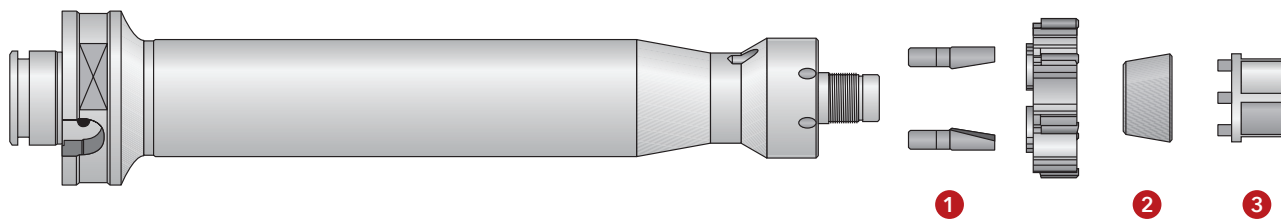

Part No. (Complete Mandrel*)	Spare Parts							Wrench Size (mm)
	1 Drive Pins	Number of Drive Pins	2 Conical Ring	Conical Ring (2nd Expansion)	Conical Ring (3rd Expansion)	3 Adjusting Key		
<b>4305-MC-010</b>	2000-CO-010	3	4001-AC-115	4001-AC-215	–	4001-CH-015	10	
<b>4305-MC-020</b>	2000-CO-020	3	4001-AC-115	4001-AC-215	–	4001-CH-015	10	
<b>4305-MC-030</b>	2000-CO-030	3	4001-AC-125	4001-AC-225	4001-AC-325	4001-CH-025	13	
<b>4305-MC-035</b>	2000-CO-040	2	4001-AC-125	4001-AC-225	4001-AC-325	4001-CH-025	13	
<b>4305-MC-040</b>	2000-CO-040	2	4001-AC-135	4001-AC-235	4001-AC-335	4001-CH-035	18	
<b>4305-MC-045</b>	2000-CO-050	2	4001-AC-135	4001-AC-235	4001-AC-335	4001-CH-035	18	
<b>4305-MC-050</b>	2000-CO-060	2	4001-AC-145	4001-AC-245	4001-AC-345	4001-CH-045	22	
<b>4305-MC-060</b>	2000-CO-060	2	4001-AC-155	4001-AC-255	4001-AC-355	4001-CH-055	26	
<b>4305-MC-070</b>	2000-CO-070	2	4001-AC-155	4001-AC-255	4001-AC-355	4001-CH-055	26	
<b>4305-MC-075</b>	2000-CO-080	2	4001-AC-155	4001-AC-255	4001-AC-355	4001-CH-055	26	
<b>4305-MC-080</b>	2000-CO-080	2	4001-AC-165	4001-AC-265	4001-AC-365	4001-CH-065	34	
<b>4305-MC-085</b>	2000-CO-090	2	4001-AC-165	4001-AC-265	4001-AC-365	4001-CH-065	34	
<b>4305-MC-090</b>	2000-CO-090	2	4001-AC-165	4001-AC-265	4001-AC-365	4001-CH-065	34	
<b>4305-MC-100</b>	2000-CO-090	2	4001-AC-185	4001-AC-285	4001-AC-385	4001-CH-085	46	
<b>4305-MC-110</b>	2000-CO-090	2	4001-AC-185	4001-AC-285	4001-AC-385	4001-CH-085	46	

\*Complete mandrel does not include cutting ring.

① = Imperial (in)  
② = Metric (mm)

## Radial Adjusting Shanks



Large range of shanks for different machine types



Highly adjustable for improved concentricity



All shanks are available with through coolant

## All the Pieces You Need

Modular System courtesy of 

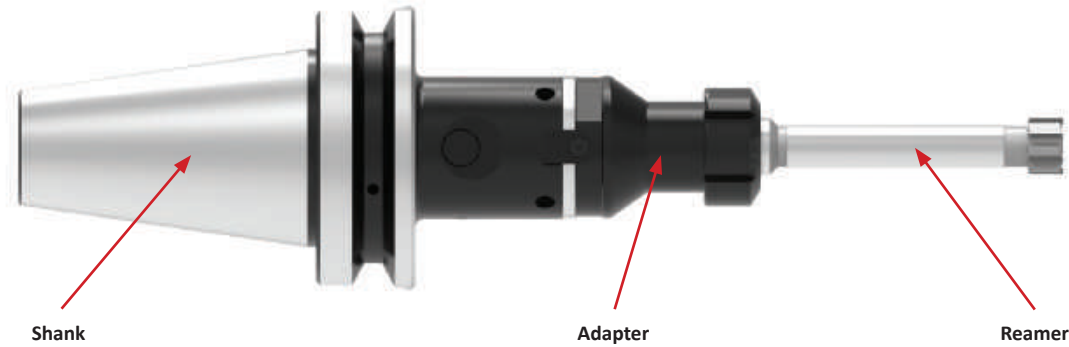

DIN 69871/1 B and A



HSK-A DIN 69893/1



JMTBA MAS-403  
BT B and BT



Straight



Collet Chuck Adapter



Cylindrical Shank  
Adapter

## Radial Adjusting Shanks

### Set-up Information

#### Radial Adjusting Shanks and Ring Style Arbors

The following is a quick guide for setting up a radial adjusting shank and a ring style reamer. The ring reamer arbor does not contain the tang needed to connect to the shank. The tang must first be removed from the shank and then installed into the reamer arbor (demonstrated below).



**Step 1:**  
The tang comes installed with the shank. Loosen the clamping screw on each side and remove the tang from the shank.



**Step 2:**  
Thread the tang into the back end of the ring arbor. Use a bench vise and wrench to tighten.

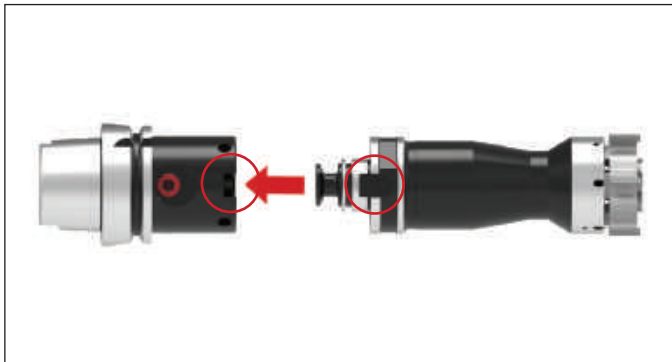

**Step 3:**  
Assemble the ring arbor to the shank. With the clamping screws still loosened, align the key on the arbor to the keyway on the shank.



**Step 4:**  
Once the ring arbor is connected with the shank, tighten the clamping screws to secure the tang back into place.

A

DRILLING

B

BORING

C

REAMING

D

BURNISHING

E

THREADING

X

SPECIALS

## Radial Adjusting Shanks

DIN 69871/1 B and A

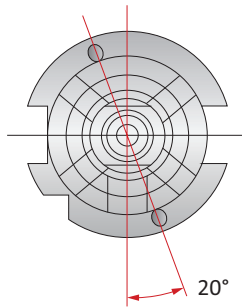

Maximum radial adjustment is  $\pm 0.008''$  (0.20mm) on diameter

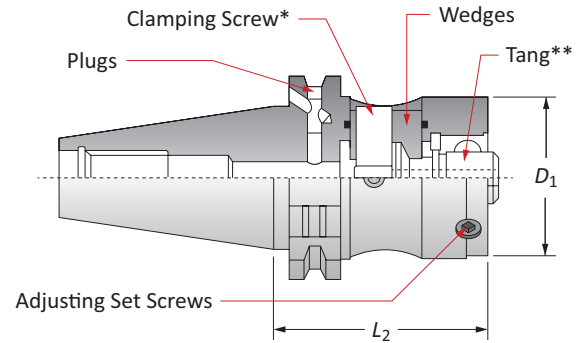

Shank				Spare Parts							
ISO Taper	$D_1$	$L_2$	Retention Knob Thread Size	Part No.	Wedges + O-Ring	Clamping Screw*	Adjusting Set Screws	Plugs	Replacement Tang**	Clamping Screw Key	
40	50	65	M16 x 2	<b>02B.40.50L.65</b>	ATR14102.2.3	ATR14102.1	M8x1x10G	M5x5TG	ATT14103	6mm	
40	63	85	M16 x 2	<b>02B.40.63L.85</b>	ATR14108.2.3	ATR14108.1	M8x1x14G	M5x5TG	ATT14104	6mm	
45	50	70	M20 x 2.5	<b>02B.45.50L.70</b>	ATR14102.2.3	ATR14102.1	M8x1x10G	M5x5TG	ATT14103	6mm	
45	63	70	M20 x 2.5	<b>02B.45.63L.70</b>	ATR14108.2.3	ATR14108.1	M8x1x14G	M5x5TG	ATT14104	6mm	
50	50	70	M24 x 3	<b>02B.50.50L.70</b>	ATR14102.2.3	ATR14102.1	M8x1x10G	M5x5TG	ATT14103	6mm	
50	63	70	M24 x 3	<b>02B.50.63L.70</b>	ATR14108.2.3	ATR14108.1	M8x1x14G	M5x5TG	ATT14104	6mm	
50	80	70	M24 x 3	<b>❖ 02B.50.80L.70</b>	ATR18775.2.3	ATR18775.1	M8x1x20G	M5x5TG	ATT14104	6mm	

\* Light torque exerted on the clamping screw transmits high axial forces, which provide stiffness and extreme accuracy to the assembly.

\*\* Tang must be fitted to all reamer arbors and adapters prior to assembly.

❖ Could cause interference with tool changer mechanism.

**NOTE:** Shanks can be converted into DIN 69871/1A coolant by screwing the two plugs clockwise to the end of their stroke.

C: 55



Key on C: 1

Modular System courtesy of 

Reference Key

Symbol	Attribute
$D_1$	Modular shank size
$L_2$	Gage length



## Radial Adjusting Shanks

JMTBA MAS-403 BT B and BT

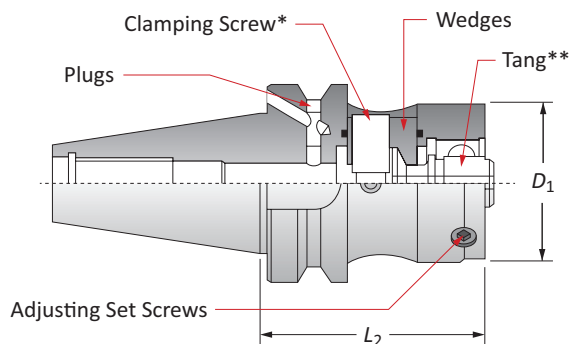
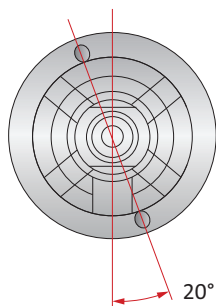

Maximum radial adjustment is  $\pm 0.008''$  (0.20mm) on diameter.

Shank				Spare Parts							
BT Taper	$D_1$	$L_2$	Retention Knob Thread Size	Part No.	Wedges + O-ring	Clamping Screw*	Adjusting Set Screws	Plugs	Replacement Tang**	Clamping Screw Key	
40	50	70	M16 x 2	<b>BTB.40.50L.70</b>	ATR14102.2.3	ATR14102.1	M8x1x10G	M5x5TG	ATT14103	6mm	
40	63	80	M16 x 2	<b>BTB.40.63L.80</b>	ATR14108.2.3	ATR14108.1	M8x1x14G	M5x5TG	ATT14104	6mm	
50	50	90	M24 x 3	<b>BTB.50.50L.90</b>	ATR14102.2.3	ATR14102.1	M8x1x10G	M5x5TG	ATT14103	6mm	
50	63	90	M24 x 3	<b>BTB.50.63L.90</b>	ATR14108.2.3	ATR14108.1	M8x1x14G	M5x5TG	ATT14104	6mm	
50	80	90	M24 x 3	<b>BTB.50.80L.90</b>	ATR18775.2.3	ATR18775.1	M8x1x20G	M5x5TG	ATT14104	6mm	

\* Light torque exerted on the clamping screw transmits high axial forces, which provide stiffness and extreme accuracy to the assembly.

\*\* Tang must be fitted to all ring arbors and adapters prior to assembly.

**NOTE:** Shanks can be converted into MAS-403 BT coolant by screwing the two plugs clockwise to the end of their stroke.

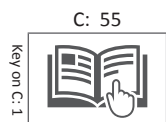

C: 55

Modular System courtesy of

Reference Key	
Symbol	Attribute
$D_1$	Modular shank size
$L_2$	Gage length

A DRILLING  
B BORING  
C REAMING  
D BURNISHING  
E THREADING  
X SPECIALS

## Radial Adjusting Shanks

HSK-A DIN 69893/1

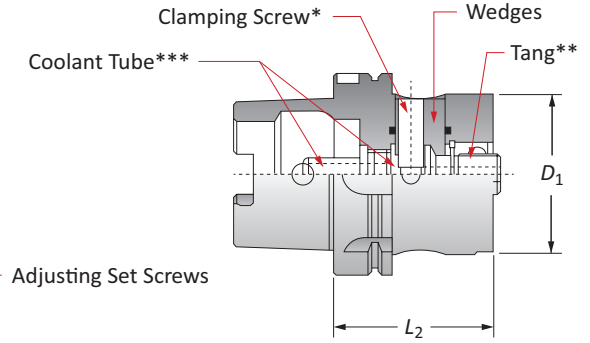
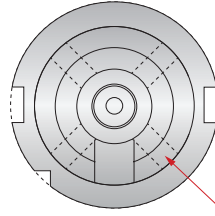

Shank			Spare Parts							
HSK	$D_1$	$L_2$	Part No.	Wedges + O-Ring	Clamping Screw*	Adjusting Set Screws	Replacement Tang**	Clamping Screw Key	Coolant Tube Key	Coolant Tube***
63	50	70	<b>HSKA.63.50L.70</b>	ATR14102.2.3	ATR14102.1	M8x1x10G	ATT14103	6mm	ATR23856	ATT23728
63	63	75	<b>HSKA.63.63L.75</b>	ATR.41613.4	ATR14108.1	M8x1x14G	ATT14104	6mm	ATR23856	ATT23728
100	50	80	<b>HSKA.100.50L.80</b>	ATR14102.2.3	ATR14102.1	M8x1x10G	ATT14103	6mm	ATR23856	ATT23656
100	63	80	<b>HSKA.100.63L.80</b>	ATR14108.2.3	ATR14108.1	M8x1x14G	ATT14104	6mm	ATR23856	ATT23656
100	80	80	<b>HSKA.100.80L.80</b>	ATR18775.2.3	ATR18775.1	M8x1x20G	ATT14104	6mm	ATR23856	ATT23656

\* Light torque exerted on the clamping screw transmits high axial forces, which provide stiffness and extreme accuracy to the assembly.

\*\* Tang must be fitted to all ring arbors and adapters prior to assembly.

\*\*\* Coolant tube sold separately.

C: 55



Key on C: 1

Modular System courtesy of 

Reference Key

Symbol	Attribute
$D_1$	Modular shank size
$L_2$	Gage length



## Radial Adjusting Shanks

Straight

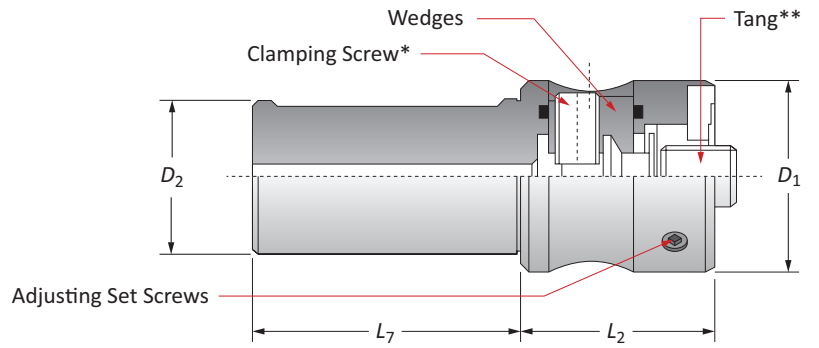

Shank				Part No.	Spare Parts				
$D_1$	$D_2$	$L_2$	$L_7$		Wedges + O-Ring	Clamping Screw*	Adjusting Set Screws	Replacement Tang**	Clamping Screw Key
50	25	50	70	<b>CIL.25.50.50</b>	ATR14102.2.3	ATR14102.1	M8x1x10G	ATT14103	6mm
50	32	50	70	<b>CIL.32.50.50</b>	ATR14102.2.3	ATR14102.1	M8x1x10G	ATT14103	6mm
50	40	50	70	<b>CIL.40.50.50</b>	ATR14102.2.3	ATR14102.1	M8x1x10G	ATT14103	6mm

\* Light torque exerted on the clamping screw transmits high axial forces, which provide stiffness and extreme accuracy to the assembly.

\*\* Tang must be fitted to all ring arbors and adapters prior to assembly.

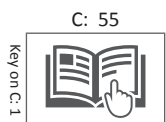

C: 55

Modular System courtesy of CERIT

Reference Key	
Symbol	Attribute
$D_1$	Modular shank size
$D_2$	Shank diameter
$L_2$	Gage length
$L_7$	Shank length

## Radial Adjusting Adapters

### Collet Chuck Adapters

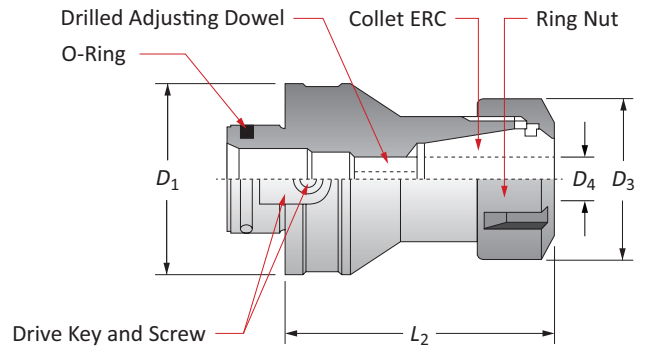

Collet Sleeve Size*	Adapter				Part No.	Spare Parts					
	$D_1$	$D_3$	$D_4$	$L_2$		Clamping Screw	Ring Nut	Adjusting Dowel	Drive Key	Ring Nut Wrench	Adjusting Dowel Key
ERC25	50	42	0.5 - 16mm	70	<b>30.50R.25.70</b>	M4x8V	G25S	M12x16GF	TAB3924	CH25S	6mm
ERC32	50	50	1 - 20mm	70	<b>30.50R.32.70</b>	M4x8V	G32S	M16x15x18GF	TAB3924	CH32S	8mm
ERC32	63	50	1 - 20mm	90	<b>30.63R.32.90</b>	M6x12V	G32S	M12x16GF	TAB3923.1	CH32S	6mm
ERC40	63	63	2 - 30mm	90	<b>30.63R.40.90</b>	M6x12V	G40S	M20x2x20GF	TAB3923.1	CH40S	10mm
ERC32	80	50	1 - 20mm	90	<b>30.80R.32.90</b>	M6x16V	G32S	M12x16GF	TAB3923.2	CH32S	6mm
ERC40	80	63	2 - 30mm	90	<b>30.80R.40.90</b>	M6x16V	G40S	M20x2x20GF	TAB3923.2	CH40S	10mm

\*Collet sleeve not included

#### Reference Key

Symbol	Attribute
$D_1$	Modular shank size
$D_3$	Body diameter
$D_4$	Shank diameter
$L_2$	Gage length

C: 55



Modular System courtesy of 



## Radial Adjusting Adapters

### Cylindrical Shank Adapters

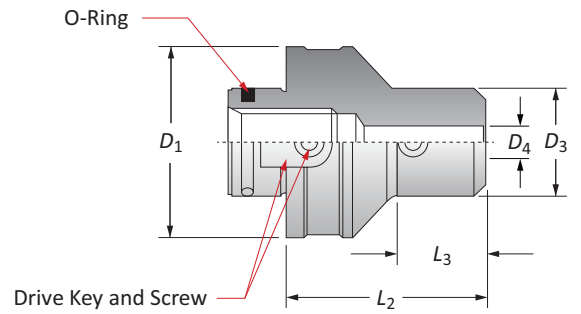

Adapter					Spare Parts				
$D_1$	$D_4$	$D_3$	$L_2$	$L_3$	Part No.	Drive Key	Screw	Set Screw	Set Screw Key
50	6	25	50	22.5	<b>35.50R.06.50</b>	TAB3924	M4x8V	M6x8G	3mm
50	8	28	50	24.5	<b>35.50R.08.50</b>	TAB3924	M4x8V	M8x8G	4mm
50	10	35	50	26.5	<b>35.50R.10.50</b>	TAB3924	M4x8V	M10x10G	5mm
50	12	42	60	38.5	<b>35.50R.12.60</b>	TAB3924	M4x8V	M12x12G	6mm
50	14	44	60	42	<b>35.50R.14.60</b>	TAB3924	M4x8V	M12x12G	6mm
50	16	48	60	40	<b>35.50R.16.60</b>	TAB3924	M4x8V	M14x14G	6mm
50	18	50	60	-	<b>35.50R.18.60</b>	TAB3924	M4x8V	M14x14G	6mm
50	20	52	60	41	<b>35.50R.20.60</b>	TAB3924	M4x8V	M16x2x14G	8mm
63	8	28	60	28	<b>35.63R.08.60</b>	TAB3923.1	M6x12V	M8x8G	4mm
63	10	35	70	40	<b>35.63R.10.70</b>	TAB3923.1	M6x12V	M10x10G	5mm
63	12	42	70	42	<b>35.63R.12.70</b>	TAB3923.1	M6x12V	M12x12G	6mm
63	14	44	60	32	<b>35.63R.14.60</b>	TAB3923.1	M6x12V	M12x12G	6mm
63	16	48	70	44	<b>35.63R.16.70</b>	TAB3923.1	M6x12V	M14x14G	6mm
63	18	50	70	40	<b>35.63R.18.70</b>	TAB3923.1	M6x12V	M14x14G	6mm
63	20	52	70	45	<b>35.63R.20.70</b>	TAB3923.1	M6x12V	M16x2x14G	8mm
50	25	65	80	61	<b>40.50R.25.80</b>	TAB3924	M4x8V	M18x2x18G	8mm
50	32	72	80	65	<b>40.50R.32.80</b>	TAB3924	M4x8V	M20x2x18G	10mm
63	25	65	80	58	<b>40.63R.25.80</b>	TAB3923.1	M6x12V	M18x2x18G	8mm
63	32	72	80	-	<b>40.63R.32.80</b>	TAB3923.1	M6x12V	M20x2x18G	10mm
80	25	65	80	50.5	<b>40.80R.25.80</b>	TAB3923.2	M6x12V	M18x2x18G	8mm
80	32	72	80	54	<b>40.80R.32.80</b>	TAB3923.2	M6x12V	M20x2x18G	10mm

Reference Key	
Symbol	Attribute
$D_1$	Modular shank size
$D_3$	Body diameter
$D_4$	Shank diameter
$L_2$	Gage length
$L_3$	Reference length

C: 55



Modular System courtesy of 

## Recommended Cutting Data | Imperial (inch)

### Replaceable Head Style

ISO	Material	Hardness (BHN)	Speed (SFM)			Recommended Feed (IPR) by Reamer Diameter					
			Uncoated Carbide	Coated Carbide	Cermet	.4646 - .8504		.8505 - 1.5590		1.5591 - 2.3858	
						Lead A, G	Lead E, N, M	Lead A, G	Lead E, N, M	Lead A, G	Lead E, N, M
P	<b>Free Machining Steel</b> 1118, 1215, 12L14, etc.	100 - 180	35 - 65	200 - 260	300 - 980	.010 - .024	.020 - .024	.012 - .031	.024 - .047	.024 - .039	.028 - .059
		180 - 250	25 - 50	130 - 230	260 - 600	.012 - .024	.016 - .031	.016 - .031	.020 - .039	.020 - .035	.024 - .047
	<b>Low Carbon Steel</b> 1010, 1020, 1025, 1522, 1144, etc.	85 - 180	35 - 65	200 - 260	300 - 980	.010 - .024	.020 - .024	.012 - .031	.024 - .047	.024 - .039	.028 - .059
		180 - 275	25 - 50	130 - 230	260 - 600	.012 - .024	.016 - .031	.016 - .031	.020 - .039	.020 - .035	.024 - .047
	<b>Medium Carbon Steel</b> 1030, 1040, 1050, 1527, 1140, 1151, etc.	125 - 180	35 - 65	200 - 260	300 - 980	.010 - .024	.020 - .024	.012 - .031	.024 - .047	.024 - .039	.028 - .059
		180 - 325	25 - 50	130 - 230	260 - 600	.012 - .024	.016 - .031	.016 - .031	.020 - .039	.020 - .035	.024 - .047
	<b>Alloy Steel</b> 4140, 5140, 8640, etc.	125 - 180	25 - 50	130 - 230	260 - 600	.010 - .024	.020 - .024	.012 - .031	.024 - .047	.024 - .039	.028 - .059
		180 - 375	15 - 35	50 - 100	200 - 390	.012 - .024	.016 - .031	.016 - .031	.020 - .039	.020 - .035	.024 - .047
	<b>High Strength Alloy</b> 4340, 4330V, 300M, etc.	240 - 450	15 - 35	50 - 100	200 - 390	.010 - .020	.012 - .024	.012 - .024	.016 - .031	.016 - .028	.020 - .039
S	<b>High Temp Alloy</b> Hastelloy B, Inconel 600, etc.	140 - 310	20 - 50	60 - 200	-	.008 - .016	-	.012 - .020	-	.016 - .024	-
	<b>Titanium Alloy</b>	140 - 310	20 - 50	60 - 200	-	.008 - .016	-	.012 - .020	-	.016 - .024	-
M	<b>Stainless Steel 400 Series</b> 416, 420, etc.	135 - 350	20 - 35	100 - 160	200 - 490	.012 - .024	.016 - .031	.016 - .031	.020 - .039	.020 - .035	.024 - .047
	<b>Stainless Steel 300 Series</b> 304, 316, 17-4PH, etc.	135 - 275	20 - 35	100 - 160	200 - 490	.012 - .024	.016 - .031	.016 - .031	.020 - .039	.020 - .035	.024 - .047
K	<b>Grey Cast Iron, Ductile Cast Iron,</b>	< 200	65 - 130	160 - 230	-	.008 - .024	.020 - .039	.012 - .028	.024 - .047	.024 - .051	.031 - .063
	<b>Spheroidal Cast Iron (Pearlitic)</b>	> 200	50 - 100	160 - 230	-	.008 - .024	.020 - .039	.012 - .028	.024 - .047	.024 - .051	.031 - .063
	<b>Spheroidal Cast Iron (Ferritic)</b>	260 - 320	30 - 50	100 - 160	200 - 400	.008 - .024	.020 - .024	.012 - .028	.024 - .047	.016 - .031	.031 - .063
N	<b>Copper and Alloys</b>	< 500	200 - 660	330 - 660	-	.008 - .024	-	.012 - .028	-	.016 - .031	-
	<b>Brass</b>										
	<b>Bronze</b>	< 180	65 - 130	260 - 520	330 - 980	.012 - .024	.016 - .039	.012 - .024	.020 - .047	.012 - .024	.024 - .059
	<b>Bronze Phosphorous</b>										
	<b>Aluminum and Alloys</b>	< 150	65 - 660	-	-	.012 - .024	-	.016 - .039	-	.016 - .039	-

#### Formulas

<p>1. <b>RPM = (SFM • 3.82) / DIA</b></p> <p>where:</p> <p>RPM = revolutions per minute (rev/min)</p> <p>SFM = speed (ft/min)</p> <p>DIA = diameter of reamer (inch)</p>	<p>2. <b>IPM = RPM • IPR</b></p> <p>where:</p> <p>IPM = inches per minute (in/min)</p> <p>RPM = revolutions per minute (rev/min)</p> <p>IPR = feed rate (in/rev)</p>	<p>3. <b>SFM = RPM • 0.262 • DIA</b></p> <p>where:</p> <p>SFM = speed (ft/min)</p> <p>RPM = revolutions per minute (rev/min)</p> <p>DIA = diameter of reamer (inch)</p>
--	--	---

**IMPORTANT:** The speeds and feeds listed on these pages are a general starting point for all applications. Factory technical assistance is available through our Application Engineering department.

## Stock Allowance and Coolant | Imperial (inch)

Replaceable Head Style

ISO	Material	Hardness (BHN)	Coolant	Recommended Stock (inch) by Reamer Diameter*		
				.4646 - .8504	.8505 - 1.5590	1.5591 - 2.3858
P	<b>Free Machining Steel</b> 1118, 1215, 12L14, etc.	100 - 180	Water Soluble Cutting Oil	.006 - .010	.008 - .016	.012 - .016
		180 - 250				
	<b>Low Carbon Steel</b> 1010, 1020, 1025, 1522, 1144, etc.	85 - 180				
		180 - 275				
	<b>Medium Carbon Steel</b> 1030, 1040, 1050, 1527, 1140, 1151, etc.	125 - 180				
		180 - 325				
	<b>Alloy Steel</b> 4140, 5140, 8640, etc.	125 - 180				
		180 - 375				
	<b>High Strength Alloy</b> 4340, 4330V, 300M, etc.	240 - 450				
S	<b>High Temp Alloy</b> Hastelloy B, Inconel 600, etc.	140 - 310	Water Soluble Cutting Oil	.006 - .010	.008 - .016	.012 - .016
		140 - 310				
	<b>Titanium Alloy</b>	140 - 310				
M	<b>Stainless Steel 400 Series</b> 416, 420, etc.	135 - 350	Water Soluble Cutting Oil	.006 - .010	.008 - .016	.012 - .016
	<b>Stainless Steel 300 Series</b> 304, 316, 17-4PH, etc.	135 - 275				
K	<b>Grey Cast Iron, Ductile Cast Iron, Spheroidal Cast Iron (Pearlitic)</b>	< 200	Water Soluble Cutting Oil	.006 - .010	.008 - .016	.012 - .016
		> 200				
	<b>Spheroidal Cast Iron (Ferritic)</b>	260 - 320				
N	<b>Copper and Alloys</b>	< 500	Water Soluble	.006 - .010	.008 - .016	.012 - .016
	<b>Brass</b>					
	<b>Bronze</b>	< 180	Water Soluble Cutting Oil			
	<b>Bronze Phosphorous</b>					
	<b>Aluminum and Alloys</b>	< 150	Water Soluble Cutting Oil			

\*Stock value is on diameter.

A  
DRILLING  
B  
BORING  
C  
REAMING  
D  
URNISHING  
E  
HREADING  
X  
PECIALS

## Recommended Cutting Data | Imperial (inch)

### Monobloc Style

ISO	Material	Hardness (BHN)	Speed (SFM)			Recommended Feed (IPR) by Reamer Diameter					
			Uncoated Carbide	Coated Carbide	Cermet	.2283 - .3940		.3941 - .7090		.7091 - 1.2638	
						Lead A, G	Lead E, N, M	Lead A, G	Lead E, N, M	Lead A, G	Lead E, N, M
P	<b>Free Machining Steel</b> 1118, 1215, 12L14, etc.	100 - 180	25 - 50	200 - 260	300 - 980	.008 - .016	.012 - .024	.016 - .024	.016 - .047	.020 - .031	.024 - .047
		180 - 250	20 - 35	130 - 230	260 - 660	.008 - .016	.012 - .020	.012 - .024	.012 - .031	.016 - .028	.016 - .047
	<b>Low Carbon Steel</b> 1010, 1020, 1025, 1522, 1144, etc.	85 - 180	25 - 50	200 - 260	300 - 980	.008 - .016	.012 - .024	.016 - .024	.016 - .047	.020 - .031	.024 - .047
		180 - 275	20 - 35	130 - 230	260 - 660	.008 - .016	.012 - .020	.012 - .024	.012 - .031	.016 - .028	.016 - .047
	<b>Medium Carbon Steel</b> 1030, 1040, 1050, 1527, 1140, 1151, etc.	125 - 180	25 - 50	200 - 260	300 - 980	.008 - .016	.012 - .024	.016 - .024	.016 - .047	.020 - .031	.024 - .047
		180 - 325	20 - 35	130 - 230	260 - 660	.008 - .016	.012 - .020	.012 - .024	.012 - .031	.016 - .028	.016 - .047
	<b>Alloy Steel</b> 4140, 5140, 8640, etc.	125 - 180	20 - 35	130 - 230	260 - 660	.008 - .016	.012 - .024	.016 - .024	.016 - .047	.020 - .031	.024 - .047
		180 - 375	15 - 25	100 - 160	200 - 490	.008 - .016	.012 - .020	.012 - .024	.012 - .031	.016 - .028	.016 - .047
	<b>High Strength Alloy</b> 4340, 4330V, 300M, etc.	240 - 450	10 - 20	50 - 100	200 - 390	.006 - .012	.008 - .016	.008 - .020	.012 - .024	.012 - .024	.016 - .031
S	<b>High Temp Alloy</b> Hastelloy B, Inconel 600, etc.	140 - 310	15 - 25	60 - 200	-	.006 - .012	-	.008 - .016	-	.012 - .020	-
	<b>Titanium Alloy</b>	140 - 310	15 - 25	60 - 200	-	.006 - .012	-	.008 - .016	-	.012 - .020	-
M	<b>Stainless Steel 400 Series</b> 416, 420, etc.	135 - 350	15 - 25	100 - 160	200 - 490	.008 - .016	.012 - .020	.012 - .024	.012 - .031	.016 - .028	.016 - .047
	<b>Stainless Steel 300 Series</b> 304, 316, 17-4PH, etc.	135 - 275	15 - 25	100 - 160	200 - 490	.008 - .016	.012 - .020	.012 - .024	.012 - .031	.016 - .028	.016 - .047
K	<b>Grey Cast Iron, Ductile Cast Iron,</b>	< 200	50 - 100	160 - 230	-	.008 - .016	.012 - .024	.014 - .024	.020 - .031	.016 - .047	.024 - .059
	<b>Spheroidal Cast Iron (Pearlitic)</b>	> 200	35 - 65	160 - 230	-	.008 - .016	.012 - .024	.014 - .024	.020 - .031	.016 - .047	.024 - .059
	<b>Spheroidal Cast Iron (Ferritic)</b>	260 - 320	25 - 40	100 - 160	200 - 400	.008 - .016	.012 - .024	.014 - .024	.020 - .031	.016 - .047	.024 - .059
N	<b>Copper and Alloys</b>	< 500	35 - 60	330 - 660	-	.008 - .016	-	.016 - .028	-	.020 - .031	-
	<b>Brass</b>										
	<b>Bronze</b>	< 180	35 - 65	260 - 520	330 - 980	.006 - .012	-	.008 - .016	-	.012 - .024	-
	<b>Bronze Phosphorous</b>										
	<b>Aluminum and Alloys</b>	< 150	50 - 100	330 - 660	-	.008 - .016	-	.016 - .028	-	.020 - .031	-

### Formulas

<p>1. <b>RPM = (SFM • 3.82) / DIA</b></p> <p>where:</p> <p>RPM = revolutions per minute (rev/min)</p> <p>SFM = speed (ft/min)</p> <p>DIA = diameter of reamer (inch)</p>	<p>2. <b>IPM = RPM • IPR</b></p> <p>where:</p> <p>IPM = inches per minute (in/min)</p> <p>RPM = revolutions per minute (rev/min)</p> <p>IPR = feed rate (in/rev)</p>	<p>3. <b>SFM = RPM • 0.262 • DIA</b></p> <p>where:</p> <p>SFM = speed (ft/min)</p> <p>RPM = revolutions per minute (rev/min)</p> <p>DIA = diameter of reamer (inch)</p>
--	--	---

**IMPORTANT:** The speeds and feeds listed on these pages are a general starting point for all applications. Factory technical assistance is available through our Application Engineering department.

## Stock Allowance and Coolant | Imperial (inch)

Monobloc Style

ISO	Material	Hardness (BHN)	Coolant	Recommended Stock (inch) by Reamer Diameter*		
				.2283 - .3940	.3941 - .7090	.7091 - 1.2638
P	<b>Free Machining Steel</b> 1118, 1215, 12L14, etc.	100 - 180	Water Soluble Cutting Oil	.006 - .012	.008 - .016	.010 - .020
		180 - 250				
	<b>Low Carbon Steel</b> 1010, 1020, 1025, 1522, 1144, etc.	85 - 180				
		180 - 275				
	<b>Medium Carbon Steel</b> 1030, 1040, 1050, 1527, 1140, 1151, etc.	125 - 180				
		180 - 325				
	<b>Alloy Steel</b> 4140, 5140, 8640, etc.	125 - 180				
		180 - 375				
	<b>High Strength Alloy</b> 4340, 4330V, 300M, etc.	240 - 450				
	<b>Structural Steel</b> A36, A285, A516	125 - 180				
		180 - 350				
	<b>Tool Steel</b> H-13, H-21, A-4, O-2, S-3, etc.	150 - 200				
		200 - 250				
S	<b>High Temp Alloy</b> Hastelloy B, Inconel 600, etc.	140 - 310	Water Soluble Cutting Oil	.008 - .016	.012 - .016	.012 - .020
	<b>Titanium Alloy</b>	140 - 310				
M	<b>Stainless Steel 400 Series</b> 416, 420, etc.	135 - 350	Water Soluble Cutting Oil	.006 - .012	.008 - .016	.010 - .020
	<b>Stainless Steel 300 Series</b> 304, 316, 17-4PH, etc.	135 - 275				
K	<b>Grey Cast Iron, Ductile Cast Iron, Spheroidal Cast Iron (Pearlitic)</b>	< 200	Water Soluble Cutting Oil	.006 - .012	.008 - .016	.010 - .020
		> 200				
	<b>Spheroidal Cast Iron (Ferritic)</b>	260 - 320				
N	<b>Copper and Alloys</b>	< 500	Water Soluble	.006 - .012	.008 - .016	.010 - .020
	<b>Brass</b>					
	<b>Bronze</b>	< 180	Water Soluble Cutting Oil			
	<b>Bronze Phosphorous</b>					
	<b>Aluminum and Alloys</b>	< 150	Water Soluble Cutting Oil			

\*Stock value is on diameter.

A  
DRILLING  
B  
BORING  
C  
REAMING  
D  
URNISHING  
E  
HREADING  
X  
PECIALS

## Recommended Cutting Data | Imperial (inch)

### Cutting Ring Style

ISO	Material	Hardness (BHN)	Speed (SFM)			Recommended Feed (IPR) by Reamer Diameter					
			Uncoated Carbide	Coated Carbide	Cermet	.6929 - 1.5750		1.5751 - 3.1500		3.1501 - 7.8972	
						Lead A, G	Lead E, N, M	Lead A, G	Lead E, N, M	Lead A, G	Lead E, N, M
P	<b>Free Machining Steel</b> 1118, 1215, 12L14, etc.	100 - 180	25 - 50	200 - 260	300 - 980	.020 - .031	.024 - .047	.020 - .039	.031 - .063	.031 - .059	.039 - .087
		180 - 250	20 - 35	130 - 230	260 - 660	.016 - .028	.016 - .039	.020 - .031	.024 - .055	.031 - .047	.039 - .079
	<b>Low Carbon Steel</b> 1010, 1020, 1025, 1522, 1144, etc.	85 - 180	25 - 50	200 - 260	300 - 980	.020 - .031	.024 - .047	.020 - .039	.031 - .063	.031 - .059	.039 - .087
		180 - 275	20 - 35	130 - 230	260 - 660	.016 - .028	.016 - .039	.020 - .031	.024 - .055	.031 - .047	.039 - .079
	<b>Medium Carbon Steel</b> 1030, 1040, 1050, 1527, 1140, 1151, etc.	125 - 180	25 - 50	200 - 260	300 - 980	.020 - .031	.024 - .047	.020 - .039	.031 - .063	.031 - .059	.039 - .087
		180 - 325	20 - 35	130 - 230	260 - 660	.016 - .028	.016 - .039	.020 - .031	.024 - .055	.031 - .047	.039 - .079
	<b>Alloy Steel</b> 4140, 5140, 8640, etc.	125 - 180	20 - 35	130 - 230	260 - 660	.020 - .031	.024 - .047	.020 - .039	.031 - .063	.031 - .059	.039 - .087
		180 - 375	15 - 25	100 - 160	200 - 490	.016 - .028	.016 - .039	.020 - .031	.024 - .055	.031 - .047	.039 - .079
	<b>High Strength Alloy</b> 4340, 4330V, 300M, etc.	240 - 450	10 - 20	50 - 100	200 - 390	.012 - .024	.016 - .031	.016 - .031	.020 - .039	.024 - .039	.028 - .055
S	<b>High Temp Alloy</b> Hastelloy B, Inconel 600, etc.	140 - 310	15 - 25	60 - 200	-	.012 - .020	-	.016 - .024	-	.020 - .028	-
	<b>Titanium Alloy</b>	140 - 310	15 - 25	60 - 200	-	.012 - .020	-	.016 - .024	-	.020 - .028	-
M	<b>Stainless Steel 400 Series</b> 416, 420, etc.	135 - 350	15 - 25	100 - 160	200 - 490	.016 - .028	.016 - .039	.020 - .031	.024 - .055	.031 - .047	.039 - .079
	<b>Stainless Steel 300 Series</b> 304, 316, 17-4PH, etc.	135 - 275	15 - 25	100 - 160	200 - 490	.016 - .028	.016 - .039	.020 - .031	.024 - .055	.031 - .047	.039 - .079
K	<b>Grey Cast Iron, Ductile Cast Iron,</b>	< 200	50 - 100	160 - 230	-	.016 - .039	.024 - .059	.024 - .051	.031 - .063	.031 - .067	.039 - .088
	<b>Spheroidal Cast Iron (Pearlitic)</b>	> 200	35 - 65	160 - 230	-	.016 - .039	.024 - .059	.024 - .051	.031 - .063	.031 - .067	.039 - .088
	<b>Spheroidal Cast Iron (Ferritic)</b>	260 - 320	25 - 40	100 - 160	200 - 400	.016 - .039	.024 - .059	.024 - .051	.031 - .063	.031 - .067	.039 - .088
N	<b>Copper and Alloys</b>	< 500	35 - 60	330 - 660	-	.020 - .031	-	.024 - .039	-	.031 - .055	-
	<b>Brass</b>										
	<b>Bronze</b>	< 180	35 - 65	260 - 520	330 - 980	.012 - .024	-	.016 - .031	-	.024 - .039	-
	<b>Bronze Phosphorous</b>										
	<b>Aluminum and Alloys</b>	< 150	50 - 100	330 - 660	-	.020 - .031	-	.024 - .039	-	.031 - .055	-

### Formulas

<p>1. <b>RPM</b> = (SFM • 3.82) / DIA</p> <p>where:</p> <p>RPM = revolutions per minute (rev/min)</p> <p>SFM = speed (ft/min)</p> <p>DIA = diameter of reamer (inch)</p>	<p>2. <b>IPM</b> = RPM • IPR</p> <p>where:</p> <p>IPM = inches per minute (in/min)</p> <p>RPM = revolutions per minute (rev/min)</p> <p>IPR = feed rate (in/rev)</p>	<p>3. <b>SFM</b> = RPM • 0.262 • DIA</p> <p>where:</p> <p>SFM = speed (ft/min)</p> <p>RPM = revolutions per minute (rev/min)</p> <p>DIA = diameter of reamer (inch)</p>
--	--	---

**IMPORTANT:** The speeds and feeds listed on these pages are a general starting point for all applications. Factory technical assistance is available through our Application Engineering department.

## Stock Allowance and Coolant | Imperial (inch)

### Cutting Ring Style

ISO	Material	Hardness (BHN)	Coolant	Recommended Stock (inch) by Reamer Diameter*		
				.6929 - 1.5750	1.5751 - 3.1500	3.1501 - 7.8972
P	<b>Free Machining Steel</b> 1118, 1215, 12L14, etc.	100 - 180	Water Soluble Cutting Oil	.006 - .012	.008 - .016	.010 - .020
		180 - 250				
	<b>Low Carbon Steel</b> 1010, 1020, 1025, 1522, 1144, etc.	85 - 180				
		180 - 275				
	<b>Medium Carbon Steel</b> 1030, 1040, 1050, 1527, 1140, 1151, etc.	125 - 180				
		180 - 325				
	<b>Alloy Steel</b> 4140, 5140, 8640, etc.	125 - 180				
		180 - 375				
	<b>High Strength Alloy</b> 4340, 4330V, 300M, etc.	240 - 450				
	<b>Structural Steel</b> A36, A285, A516	125 - 180				
		180 - 350				
	<b>Tool Steel</b> H-13, H-21, A-4, O-2, S-3, etc.	150 - 200				
		200 - 250				
S	<b>High Temp Alloy</b> Hastelloy B, Inconel 600, etc.	140 - 310	Water Soluble Cutting Oil	.008 - .016	.012 - .016	.012 - .020
	<b>Titanium Alloy</b>	140 - 310				
M	<b>Stainless Steel 400 Series</b> 416, 420, etc.	135 - 350	Water Soluble Cutting Oil	.006 - .012	.008 - .016	.010 - .020
	<b>Stainless Steel 300 Series</b> 304, 316, 17-4PH, etc.	135 - 275				
K	<b>Grey Cast Iron, Ductile Cast Iron, Spheroidal Cast Iron (Pearlitic)</b>	< 200	Water Soluble Cutting Oil	.006 - .012	.008 - .016	.010 - .020
	<b>Spheroidal Cast Iron (Ferritic)</b>	> 200				
		260 - 320				
N	<b>Copper and Alloys</b>	< 500	Water Soluble	.006 - .012	.008 - .016	.010 - .020
	<b>Brass</b>					
	<b>Bronze</b>	< 180	Water Soluble Cutting Oil			
	<b>Bronze Phosphorous</b>					
	<b>Aluminum and Alloys</b>	< 150	Water Soluble Cutting Oil			

\*Stock value is on diameter.

A  
DRILLING  
B  
BORING  
C  
REAMING  
D  
URNISHING  
E  
HREADING  
X  
PECIALS

## Recommended Cutting Data | Metric (mm)

### Replaceable Head Style

ISO	Material	Hardness (BHN)	Speed (M/min)			Recommended Feed (mm/rev) by Reamer Diameter					
			Uncoated Carbide	Coated Carbide	Cermet	11.80 - 21.60		21.61 - 39.60		39.61 - 60.60	
						Lead A, G	Lead E, N, M	Lead A, G	Lead E, N, M	Lead A, G	Lead E, N, M
P	<b>Free Machining Steel</b> 1118, 1215, 12L14, etc.	100 - 180	10 - 20	60 - 80	90 - 300	.25 - .60	.50 - .60	.30 - .80	.60 - 1.20	.60 - 1.00	.70 - 1.50
		180 - 250	7 - 15	40 - 70	80 - 200	.30 - .60	.40 - .80	.40 - .80	.50 - 1.00	.50 - .90	.60 - 1.20
	<b>Low Carbon Steel</b> 1010, 1020, 1025, 1522, 1144, etc.	85 - 180	10 - 20	60 - 80	90 - 300	.25 - .60	.50 - .60	.30 - .80	.60 - 1.20	.60 - 1.00	.70 - 1.50
		180 - 275	7 - 15	40 - 70	80 - 200	.30 - .60	.40 - .80	.40 - .80	.50 - 1.00	.50 - .90	.60 - 1.20
	<b>Medium Carbon Steel</b> 1030, 1040, 1050, 1527, 1140, 1151, etc.	125 - 180	10 - 20	60 - 80	90 - 300	.25 - .60	.50 - .60	.30 - .80	.60 - 1.20	.60 - 1.00	.70 - 1.50
		180 - 325	7 - 15	40 - 70	80 - 200	.30 - .60	.40 - .80	.40 - .80	.50 - 1.00	.50 - .90	.60 - 1.20
	<b>Alloy Steel</b> 4140, 5140, 8640, etc.	125 - 180	6 - 10	40 - 70	80 - 200	.25 - .60	.50 - .60	.30 - .80	.60 - 1.20	.60 - 1.00	.70 - 1.50
		180 - 375	4 - 8	30 - 50	60 - 150	.30 - .60	.40 - .80	.40 - .80	.50 - 1.00	.50 - .90	.60 - 1.20
	<b>High Strength Alloy</b> 4340, 4330V, 300M, etc.	240 - 450	3 - 6	15 - 30	60 - 120	.25 - .50	.30 - .60	.30 - .60	.40 - .80	.40 - .70	.50 - 1.00
S	<b>High Temp Alloy</b> Hastelloy B, Inconel 600, etc.	140 - 310	4 - 10	30 - 50	—	.20 - .40	—	.30 - .50	—	.40 - .60	—
	<b>Titanium Alloy</b>	140 - 310	4 - 15	30 - 50	—	.20 - .40	—	.30 - .50	—	.40 - .60	—
M	<b>Stainless Steel 400 Series</b> 416, 420, etc.	135 - 350	4 - 10	30 - 50	60 - 150	.30 - .60	.40 - .80	.40 - .80	.50 - 1.00	.50 - .90	.60 - 1.20
	<b>Stainless Steel 300 Series</b> 304, 316, 17-4PH, etc.	135 - 275	4 - 10	30 - 50	60 - 150	.30 - .60	.40 - .80	.40 - .80	.50 - 1.00	.50 - .90	.60 - 1.20
K	<b>Grey Cast Iron, Ductile Cast Iron,</b>	< 200	20 - 40	50 - 70	—	.20 - .60	.50 - 1.00	.30 - .70	.60 - 1.20	.60 - 1.30	.80 - 1.60
	<b>Spheroidal Cast Iron (Pearlitic)</b>	> 200	15 - 30	50 - 70	—	.20 - .60	.50 - 1.00	.30 - .70	.60 - 1.20	.60 - 1.30	.80 - 1.60
	<b>Spheroidal Cast Iron (Ferritic)</b>	260 - 320	10 - 15	30 - 50	60 - 120	.20 - .60	.50 - .60	.30 - .70	.60 - 1.20	.40 - .80	.80 - 1.60
N	<b>Copper and Alloys</b>	< 500	60 - 200	100 - 200	—	.20 - .60	—	.30 - .70	—	.40 - .80	—
	<b>Brass</b>										
	<b>Bronze</b>	< 180	20 - 40	80 - 160	100 - 300	.30 - .60	.40 - 1.00	.30 - .60	.50 - 1.20	.30 - .60	.60 - 1.50
	<b>Bronze Phosphorous</b>										
	<b>Aluminum and Alloys</b>	< 150	20 - 200	—	—	.30 - .60	—	.40 - 1.00	—	.40 - 1.00	—

#### Formulas

<p>1. <math>RPM = M/min \cdot 3.82 \cdot DIA</math></p> <p>where:</p> <p>RPM = revolutions per minute (rev/min)</p> <p>M/min = speed (M/min)</p> <p>DIA = diameter of reamer (mm)</p>	<p>2. <math>mm/min = RPM \cdot mm/rev</math></p> <p>where:</p> <p>mm/min = mm per minute (mm/min)</p> <p>RPM = revolutions per minute (rev/min)</p> <p>mm/rev = feed rate (mm/rev)</p>	<p>3. <math>M/min = RPM \cdot 0.003 \cdot DIA</math></p> <p>where:</p> <p>M/min = speed (M/min)</p> <p>RPM = revolutions per minute (rev/min)</p> <p>DIA = diameter of reamer (mm)</p>
---	--	--

**IMPORTANT:** The speeds and feeds listed on these pages are a general starting point for all applications. Factory technical assistance is available through our Application Engineering department.



## Stock Allowance and Coolant | Metric (mm)

Replaceable Head Style

ISO	Material	Hardness (BHN)	Coolant	Recommended Stock (mm) by Reamer Diameter*		
				11.80 - 21.60	21.61 - 39.60	39.61 - 60.60
P	<b>Free Machining Steel</b> 1118, 1215, 12L14, etc.	100 - 180	Water Soluble Cutting Oil	0.15 - 0.25	0.20 - 0.40	0.30 - 0.40
		180 - 250				
	<b>Low Carbon Steel</b> 1010, 1020, 1025, 1522, 1144, etc.	85 - 180				
		180 - 275				
	<b>Medium Carbon Steel</b> 1030, 1040, 1050, 1527, 1140, 1151, etc.	125 - 180				
		180 - 325				
	<b>Alloy Steel</b> 4140, 5140, 8640, etc.	125 - 180				
		180 - 375				
	<b>High Strength Alloy</b> 4340, 4330V, 300M, etc.	240 - 450				
	<b>Structural Steel</b> A36, A285, A516	125 - 180				
		180 - 350				
	<b>Tool Steel</b> H-13, H-21, A-4, O-2, S-3, etc.	150 - 200				
		200 - 250				
S	<b>High Temp Alloy</b> Hastelloy B, Inconel 600, etc.	140 - 310	Water Soluble Cutting Oil	0.15 - 0.25	0.20 - 0.40	0.30 - 0.40
	<b>Titanium Alloy</b>	140 - 310				
M	<b>Stainless Steel 400 Series</b> 416, 420, etc.	135 - 350	Water Soluble Cutting Oil	0.15 - 0.25	0.20 - 0.40	0.30 - 0.40
	<b>Stainless Steel 300 Series</b> 304, 316, 17-4PH, etc.	135 - 275				
K	<b>Grey Cast Iron, Ductile Cast Iron, Spheroidal Cast Iron (Pearlitic)</b>	< 200	Water Soluble Cutting Oil	0.15 - 0.25	0.20 - 0.40	0.30 - 0.40
	<b>Spheroidal Cast Iron (Ferritic)</b>	> 200				
		260 - 320				
N	<b>Copper and Alloys</b> Brass	< 500	Water Soluble	0.15 - 0.25	0.20 - 0.40	0.30 - 0.40
	<b>Bronze</b>	< 180	Water Soluble Cutting Oil			
	<b>Bronze Phosphorous</b>	< 180	Water Soluble Cutting Oil			
	<b>Aluminum and Alloys</b>	< 150	Water Soluble Cutting Oil			

\*Stock value is on diameter.

A  
DRILLING  
B  
BORING  
C  
REAMING  
D  
URNISHING  
E  
HREADING  
X  
PECIALS

## Recommended Cutting Data | Metric (mm)

### Monobloc Style

ISO	Material	Hardness (BHN)	Speed (M/min)			Recommended Feed (mm/rev) by Reamer Diameter					
			Uncoated Carbide	Coated Carbide	Cermet	5.80 - 10.00		10.01 - 22.00		22.01 - 32.10	
						Lead A, G	Lead E, N, M	Lead A, G	Lead E, N, M	Lead A, G	Lead E, N, M
P	<b>Free Machining Steel</b> 1118, 1215, 12L14, etc.	100 - 180	7 - 15	60 - 80	90 - 300	.20 - .40	.30 - .60	.40 - .60	.40 - 1.00	.50 - .80	.60 - 1.20
		180 - 250	6 - 10	40 - 70	80 - 200	.20 - .40	.30 - .50	.30 - .60	.30 - .80	.40 - .70	.40 - 1.00
	<b>Low Carbon Steel</b> 1010, 1020, 1025, 1522, 1144, etc.	85 - 180	7 - 15	60 - 80	90 - 300	.20 - .40	.30 - .60	.40 - .60	.40 - 1.00	.50 - .80	.60 - 1.20
		180 - 275	6 - 10	40 - 70	80 - 200	.20 - .40	.30 - .50	.30 - .60	.30 - .80	.40 - .70	.40 - 1.00
	<b>Medium Carbon Steel</b> 1030, 1040, 1050, 1527, 1140, 1151, etc.	125 - 180	7 - 15	60 - 80	90 - 300	.20 - .40	.30 - .60	.40 - .60	.40 - 1.00	.50 - .80	.60 - 1.20
		180 - 325	6 - 10	40 - 70	80 - 200	.20 - .40	.30 - .50	.30 - .60	.30 - .80	.40 - .70	.40 - 1.00
	<b>Alloy Steel</b> 4140, 5140, 8640, etc.	125 - 180	6 - 10	40 - 70	80 - 200	.20 - .40	.30 - .60	.40 - .60	.40 - 1.00	.50 - .80	.60 - 1.20
		180 - 375	4 - 8	30 - 50	60 - 150	.20 - .40	.30 - .50	.30 - .60	.30 - .80	.40 - .70	.40 - 1.00
	<b>High Strength Alloy</b> 4340, 4330V, 300M, etc.	240 - 450	3 - 6	15 - 30	60 - 120	.15 - .30	.20 - .40	.20 - .50	.30 - .60	.30 - .60	.40 - .80
S	<b>High Temp Alloy</b> Hastelloy B, Inconel 600, etc.	140 - 310	4 - 10	30 - 50	—	.15 - .30	—	.20 - .40	—	.30 - .50	—
	<b>Titanium Alloy</b>	140 - 310	4 - 15	30 - 50	—	.15 - .30	—	.20 - .40	—	.30 - .50	—
M	<b>Stainless Steel 400 Series</b> 416, 420, etc.	135 - 350	4 - 10	30 - 50	60 - 150	.20 - .40	.30 - .50	.30 - .60	.30 - .80	.40 - .70	.40 - 1.00
	<b>Stainless Steel 300 Series</b> 304, 316, 17-4PH, etc.	135 - 275	4 - 10	30 - 50	60 - 150	.20 - .40	.30 - .50	.30 - .60	.30 - .80	.40 - .70	.40 - 1.00
K	<b>Grey Cast Iron, Ductile Cast Iron,</b>	< 200	15 - 30	50 - 70	—	.20 - .40	.30 - .60	.35 - .60	.50 - .80	.40 - 1.00	.60 - 1.50
	<b>Spheroidal Cast Iron (Pearlitic)</b>	> 200	10 - 20	50 - 70	—	.20 - .40	.30 - .60	.35 - .60	.50 - .80	.40 - 1.00	.60 - 1.50
	<b>Spheroidal Cast Iron (Ferritic)</b>	260 - 320	8 - 12	30 - 50	60 - 120	.20 - .40	.30 - .60	.35 - .60	.50 - .80	.40 - 1.00	.60 - 1.50
N	<b>Copper and Alloys</b>	< 500	10 - 18	100 - 200	—	.20 - .40	—	.40 - .70	—	.50 - .80	—
	<b>Brass</b>										
	<b>Bronze</b>	< 180	10 - 20	80 - 160	100 - 300	.15 - .30	—	.20 - .40	—	.30 - .60	—
	<b>Bronze Phosphorous</b>										
	<b>Aluminum and Alloys</b>	< 150	15 - 30	100 - 200	—	.20 - .40	—	.40 - .70	—	.50 - .80	—

#### Formulas

<p>1. <math>RPM = M/min \cdot 3.82 \cdot DIA</math></p> <p>where:</p> <p>RPM = revolutions per minute (rev/min)</p> <p>M/min = speed (M/min)</p> <p>DIA = diameter of reamer (mm)</p>	<p>2. <math>mm/min = RPM \cdot mm/rev</math></p> <p>where:</p> <p>mm/min = mm per minute (mm/min)</p> <p>RPM = revolutions per minute (rev/min)</p> <p>mm/rev = feed rate (mm/rev)</p>	<p>3. <math>M/min = RPM \cdot 0.003 \cdot DIA</math></p> <p>where:</p> <p>M/min = speed (M/min)</p> <p>RPM = revolutions per minute (rev/min)</p> <p>DIA = diameter of reamer (mm)</p>
---	--	--

**IMPORTANT:** The speeds and feeds listed on these pages are a general starting point for all applications. Factory technical assistance is available through our Application Engineering department.

## Stock Allowance and Coolant | Metric (mm)

Monobloc Style

ISO	Material	Hardness (BHN)	Coolant	Recommended Stock (mm) by Reamer Diameter*		
				5.80 - 10.00	10.01 - 22.00	22.01 - 32.10
P	<b>Free Machining Steel</b> 1118, 1215, 12L14, etc.	100 - 180	Water Soluble Cutting Oil	0.08 - 0.15	0.15 - 0.25	0.15 - 0.30
		180 - 250				
	<b>Low Carbon Steel</b> 1010, 1020, 1025, 1522, 1144, etc.	85 - 180				
		180 - 275				
	<b>Medium Carbon Steel</b> 1030, 1040, 1050, 1527, 1140, 1151, etc.	125 - 180				
		180 - 325				
	<b>Alloy Steel</b> 4140, 5140, 8640, etc.	125 - 180				
		180 - 375				
	<b>High Strength Alloy</b> 4340, 4330V, 300M, etc.	240 - 450				
	<b>Structural Steel</b> A36, A285, A516	125 - 180				
		180 - 350				
	<b>Tool Steel</b> H-13, H-21, A-4, O-2, S-3, etc.	150 - 200				
		200 - 250				
S	<b>High Temp Alloy</b> Hastelloy B, Inconel 600, etc.	140 - 310	Water Soluble Cutting Oil	0.10 - 0.20	0.15 - 0.25	0.20 - 0.40
	<b>Titanium Alloy</b>	140 - 310				
M	<b>Stainless Steel 400 Series</b> 416, 420, etc.	135 - 350	Water Soluble Cutting Oil	0.08 - 0.15	0.15 - 0.25	0.15 - 0.30
	<b>Stainless Steel 300 Series</b> 304, 316, 17-4PH, etc.	135 - 275				
K	<b>Grey Cast Iron, Ductile Cast Iron, Spheroidal Cast Iron (Pearlitic)</b>	< 200	Water Soluble Cutting Oil	0.08 - 0.15	0.15 - 0.25	0.15 - 0.30
	<b>Spheroidal Cast Iron (Ferritic)</b>	> 200				
		260 - 320				
N	<b>Copper and Alloys</b>	< 500	Water Soluble	0.08 - 0.15	0.15 - 0.25	0.15 - 0.30
	<b>Brass</b>					
	<b>Bronze</b>	< 180	Water Soluble Cutting Oil			
	<b>Bronze Phosphorous</b>					
	<b>Aluminum and Alloys</b>	< 150	Water Soluble Cutting Oil			

\*Stock value is on diameter.

A  
DRILLING  
B  
BORING  
C  
REAMING  
D  
URNISHING  
E  
HREADING  
X  
PECIALS

## Recommended Cutting Data | Metric (mm)

### Cutting Ring Style

ISO	Material	Hardness (BHN)	Speed (M/min)			Recommended Feed (mm/rev) by Reamer Diameter					
			Uncoated Carbide	Coated Carbide	Cermet	17.60 - 40.00		40.01 - 80.00		80.01 - 200.00	
						Lead A, G	Lead E, N, M	Lead A, G	Lead E, N, M	Lead A, G	Lead E, N, M
P	<b>Free Machining Steel</b> 1118, 1215, 12L14, etc.	100 - 180	7 - 15	60 - 80	90 - 300	.50 - .80	.60 - 1.20	.50 - 1.00	.80 - 1.60	.80 - 1.50	1.00 - 2.20
		180 - 250	6 - 10	40 - 70	80 - 200	.40 - .70	.40 - 1.00	.50 - .80	.60 - 1.40	.80 - 1.20	1.00 - 2.00
	<b>Low Carbon Steel</b> 1010, 1020, 1025, 1522, 1144, etc.	85 - 180	7 - 15	60 - 80	90 - 300	.50 - .80	.60 - 1.20	.50 - 1.00	.80 - 1.60	.80 - 1.50	1.00 - 2.20
		180 - 275	6 - 10	40 - 70	80 - 200	.40 - .70	.40 - 1.00	.50 - .80	.60 - 1.40	.80 - 1.20	1.00 - 2.00
	<b>Medium Carbon Steel</b> 1030, 1040, 1050, 1527, 1140, 1151, etc.	125 - 180	7 - 15	60 - 80	90 - 300	.50 - .80	.60 - 1.20	.50 - 1.00	.80 - 1.60	.80 - 1.50	1.00 - 2.20
		180 - 325	6 - 10	40 - 70	80 - 200	.40 - .70	.40 - 1.00	.50 - .80	.60 - 1.40	.80 - 1.20	1.00 - 2.00
	<b>Alloy Steel</b> 4140, 5140, 8640, etc.	125 - 180	6 - 10	40 - 70	80 - 200	.50 - .80	.60 - 1.20	.50 - 1.00	.80 - 1.60	.80 - 1.50	1.00 - 2.20
		180 - 375	4 - 8	30 - 50	60 - 150	.40 - .70	.40 - 1.00	.50 - .80	.60 - 1.40	.80 - 1.20	1.00 - 2.00
	<b>High Strength Alloy</b> 4340, 4330V, 300M, etc.	240 - 450	3 - 6	15 - 30	60 - 120	.30 - .60	.40 - .80	.40 - .80	.50 - 1.00	.60 - 1.00	.70 - 1.40
S	<b>High Temp Alloy</b> Hastelloy B, Inconel 600, etc.	140 - 310	4 - 8	30 - 50	-	.30 - .50	-	.40 - .60	-	.50 - .70	-
	<b>Titanium Alloy</b>	140 - 310	4 - 8	30 - 50	-	.30 - .50	-	.40 - .60	-	.50 - .70	-
M	<b>Stainless Steel 400 Series</b> 416, 420, etc.	135 - 350	4 - 8	30 - 50	60 - 150	.40 - .70	.40 - 1.00	.50 - .80	.60 - 1.40	.80 - 1.20	1.00 - 2.00
	<b>Stainless Steel 300 Series</b> 304, 316, 17-4PH, etc.	135 - 275	4 - 8	30 - 50	60 - 150	.40 - .70	.40 - 1.00	.50 - .80	.60 - 1.40	.80 - 1.20	1.00 - 2.00
K	<b>Grey Cast Iron, Ductile Cast Iron,</b>	< 200	15 - 30	50 - 70	-	.40 - 1.00	.60 - 1.50	.60 - 1.30	.80 - 1.60	.80 - 1.70	1.00 - 2.25
	<b>Spheroidal Cast Iron (Pearlitic)</b>	> 200	10 - 20	50 - 70	-	.40 - 1.00	.60 - 1.50	.60 - 1.30	.80 - 1.60	.80 - 1.70	1.00 - 2.25
	<b>Spheroidal Cast Iron (Ferritic)</b>	260 - 320	8 - 12	30 - 50	60 - 120	.40 - 1.00	.60 - 1.50	.60 - 1.30	.80 - 1.60	.80 - 1.70	1.00 - 2.25
N	<b>Copper and Alloys</b>	< 500	10 - 18	100 - 200	-	.50 - .80	-	.60 - 1.00	-	.80 - 1.40	-
	<b>Brass</b>										
	<b>Bronze</b>	< 180	10 - 20	80 - 160	100 - 300	.30 - .60	-	.40 - .80	-	.60 - 1.00	-
	<b>Bronze Phosphorous</b>										
	<b>Aluminum and Alloys</b>	< 150	15 - 30	100 - 200	-	.50 - .80	-	.60 - 1.00	-	.80 - 1.40	-

### Formulas

<p>1. <math>RPM = M/min \cdot 3.82 \cdot DIA</math></p> <p>where:</p> <ul style="list-style-type: none"> <li>RPM = revolutions per minute (rev/min)</li> <li>M/min = speed (M/min)</li> <li>DIA = diameter of reamer (mm)</li> </ul>	<p>2. <math>mm/min = RPM \cdot mm/rev</math></p> <p>where:</p> <ul style="list-style-type: none"> <li>mm/min = mm per minute (mm/min)</li> <li>RPM = revolutions per minute (rev/min)</li> <li>mm/rev = feed rate (mm/rev)</li> </ul>	<p>3. <math>M/min = RPM \cdot 0.003 \cdot DIA</math></p> <p>where:</p> <ul style="list-style-type: none"> <li>M/min = speed (M/min)</li> <li>RPM = revolutions per minute (rev/min)</li> <li>DIA = diameter of reamer (mm)</li> </ul>
--	---	---

**IMPORTANT:** The speeds and feeds listed on these pages are a general starting point for all applications. Factory technical assistance is available through our Application Engineering department.

## Stock Allowance and Coolant | Metric (mm)

Cutting Ring Style

ISO	Material	Hardness (BHN)	Coolant	Recommended Stock (mm) by Reamer Diameter*		
				17.60 - 40.00	40.01 - 80.00	80.01 - 200.00
P	<b>Free Machining Steel</b> 1118, 1215, 12L14, etc.	100 - 180	Water Soluble Cutting Oil	0.15 - 0.30	0.20 - 0.40	0.25 - 0.50
		180 - 250				
	<b>Low Carbon Steel</b> 1010, 1020, 1025, 1522, 1144, etc.	85 - 180				
		180 - 275				
	<b>Medium Carbon Steel</b> 1030, 1040, 1050, 1527, 1140, 1151, etc.	125 - 180				
		180 - 325				
	<b>Alloy Steel</b> 4140, 5140, 8640, etc.	125 - 180				
		180 - 375				
	<b>High Strength Alloy</b> 4340, 4330V, 300M, etc.	240 - 450				
	<b>Structural Steel</b> A36, A285, A516	125 - 180				
		180 - 350				
	<b>Tool Steel</b> H-13, H-21, A-4, O-2, S-3, etc.	150 - 200				
		200 - 250				
S	<b>High Temp Alloy</b> Hastelloy B, Inconel 600, etc.	140 - 310	Water Soluble Cutting Oil	0.20 - 0.40	0.30 - 0.40	0.30 - 0.50
	<b>Titanium Alloy</b>	140 - 310				
M	<b>Stainless Steel 400 Series</b> 416, 420, etc.	135 - 350	Water Soluble Cutting Oil	0.15 - 0.30	0.20 - 0.40	0.25 - 0.50
	<b>Stainless Steel 300 Series</b> 304, 316, 17-4PH, etc.	135 - 275				
K	<b>Grey Cast Iron, Ductile Cast Iron, Spheroidal Cast Iron (Pearlitic)</b>	< 200	Water Soluble Cutting Oil	0.15 - 0.30	0.20 - 0.40	0.25 - 0.50
	<b>Spheroidal Cast Iron (Ferritic)</b>	> 200				
		260 - 320				
N	<b>Copper and Alloys</b>	< 500	Water Soluble	0.15 - 0.30	0.20 - 0.40	0.25 - 0.50
	<b>Brass</b>					
	<b>Bronze</b>	< 180	Water Soluble Cutting Oil			
	<b>Bronze Phosphorous</b>					
	<b>Aluminum and Alloys</b>	< 150	Water Soluble Cutting Oil			

\*Stock value is on diameter.

A  
DRILLING  
B  
BORING  
C  
REAMING  
D  
URNISHING  
E  
HREADING  
X  
PECIALS

## Set-up Information

### Replaceable Head Style

A  
DRILLING  
B  
BORING  
C  
REAMING  
D  
BURNISHING  
E  
THREADING  
X  
SPECIALS

#### Fixed Head Style

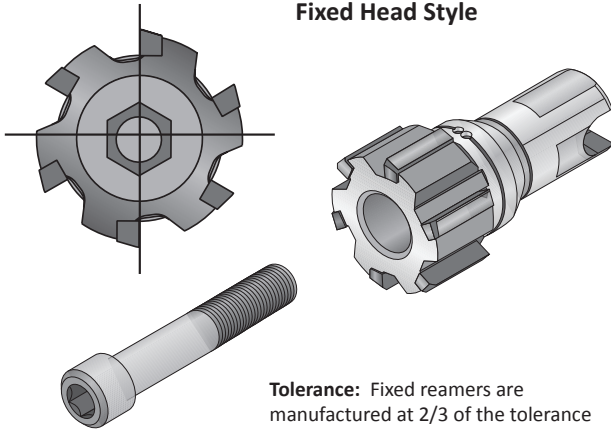

**Tolerance:** Fixed reamers are manufactured at 2/3 of the tolerance

#### Recommended Tightening Torque for Fixed Head Reamer (7400 / 7700)

Imperial		Metric	
D <sub>1</sub> Range (inch)	Torque (in-lbs)	D <sub>1</sub> Range (mm)	Torque (N-m)
0.465 - 0.575	22.1	11.80 - 14.60	2.5
0.575 - 0.693	33.6	14.61 - 17.60	3.5
0.693 - 0.850	44.3	17.61 - 21.60	5.0
0.851 - 1.047	62.0	21.61 - 26.60	7.0
1.048 - 1.283	88.5	26.61 - 32.60	10.0
1.284 - 1.598	106.2	32.61 - 40.60	12.0
1.599 - 1.992	141.6	40.61 - 50.60	16.0
1.993 - 2.386	177.0	50.61 - 60.60	20.0

#### Expandable Head Style

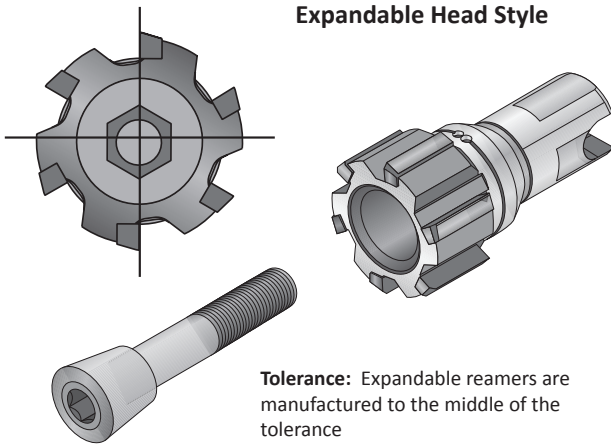

**Tolerance:** Expandable reamers are manufactured to the middle of the tolerance

#### Expanding Heads Adjustment

When the size reaches its lower tolerance, the head can be adjusted to compensate for wear to the cutting edges. This operation can be repeated several times until the surface finish of the hole deteriorates to an unacceptable level.

#### Adjustment Procedure

Slowly turn the right hand threaded screw clockwise while checking the diameter setting of the reamer with a micrometer. When the required diameter is achieved, the tool is ready for use.

### Replaceable Head Reamer Assembly

Fixed and Expandable Styles

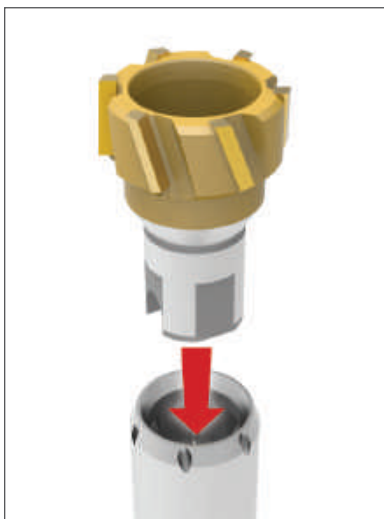

**Step 1:** Insert the replaceable reamer head into the mandrel.



**Step 2:** Insert the screw into the reamer head opening to secure it to the mandrel.

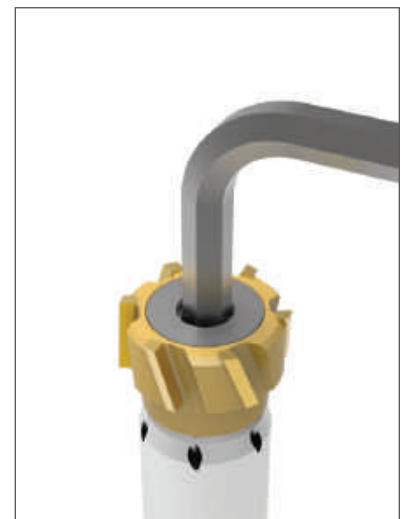

**Step 3:** Tighten the screw.

**NOTE:** We recommend lubricating the thread and the conical surface of contact between the reamer head and the screw with antifriction Molycote grease.

## Set-up Information

### Monobloc Style

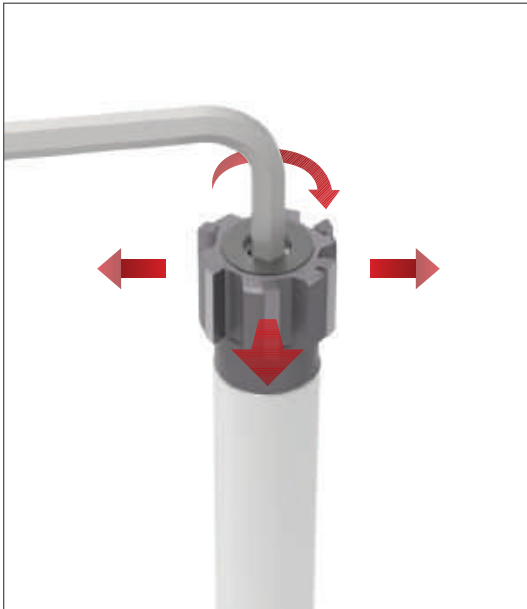

#### Tolerance

All monobloc reamers are ground to the requested diameter and set in the middle of the hole tolerance, ready for use.

#### Adjustment

The adjustment must be made to compensate for wear to the cutting edges when the size reaches its lower tolerance. This operation can be repeated several times until the surface finish of the hole deteriorates to an unacceptable level. Then the reamer must be reground. The maximum expansion is about 1% of the diameter.

A

DRILLING

B

BORING

C

REAMING

D

BURNISHING

E

THREADING

X

SPECIALS

## Set-up Information

### Cutting Ring Style

**Drive Pin**  
(11:00 position)

**Dimples**  
(12:00 position)

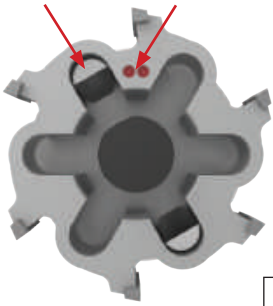

**Step 1:**  
With the drive pins assembled, insert the cutting ring onto the mandrel. Make sure the dimples are at the 12:00 position with the drive pin at the 11:00 position.

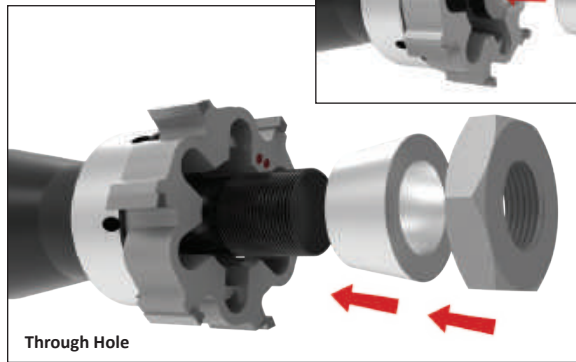
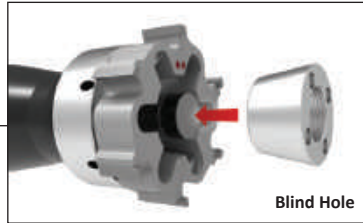

### Step 2:

Insert the conical ring. Tighten the lock nut to set the desired reamer size (left hand thread). Then loosen the lock nut slightly until it "clicks" against the drive wall.

**NOTE:** We recommend lubricating the thread and the conical surface of contact between the cutting ring and the conical ring with antifriction Molycote grease.

**For Diameter Range: 100.60mm - 200.59mm**

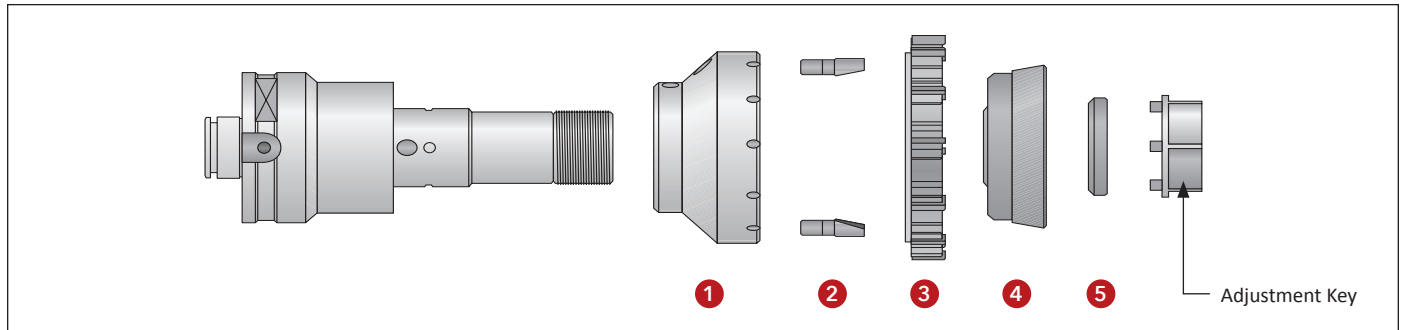

### Assembly

1. With the drive pins (2) assembled, mount the flange (1) onto the mandrel. Assemble the cutting ring (3) so the slot on the left side of the dimple is mounted onto the drive pins (2). Insert the conical ring (4).
2. Screw the ring nut (5) onto the mandrel and tighten manually so the conical ring (4) makes contact with the cutting ring (3). The thread is left handed.

**NOTE:** We recommend lubricating the thread and the conical surface of contact between the cutting ring and the conical ring with antifriction Molycote grease.

### Adjustment Procedure

1. Turn the ring nut (5) slowly using a pin spanner.
2. Check the diameter setting of the cutting ring with a micrometer. Make sure the drive pins (2) are in traction and in the opposite direction of the cutting action of the reamer.
3. When the required diameter is achieved, the tool is ready to use.



### Adjustment Procedure

1. Turn the conical ring slowly using an adjustment key (left hand thread). Adjustment keys are supplied with reamers from diameter 17.60mm to 40.59mm.
2. Check the diameter setting of the cutting ring with a micrometer.
3. When the required diameter is achieved, unscrew the conical ring until there is a click and the drive pins are in traction in the opposite direction to the cutting action of the reamer. The reamer is ready for use.



## Diameter Measurement

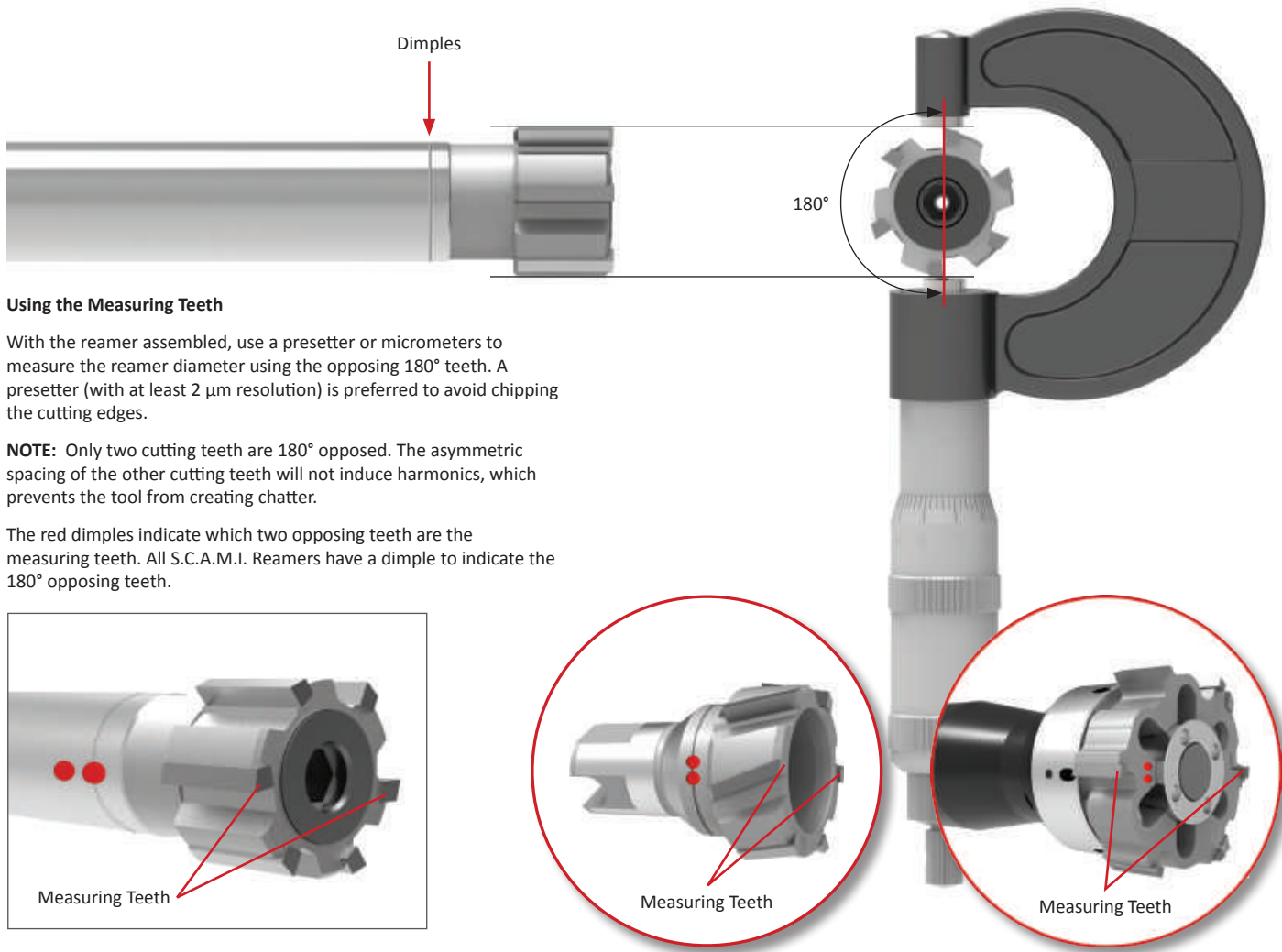

### Using the Measuring Teeth

With the reamer assembled, use a presetter or micrometers to measure the reamer diameter using the opposing 180° teeth. A presetter (with at least 2 µm resolution) is preferred to avoid chipping the cutting edges.

**NOTE:** Only two cutting teeth are 180° opposed. The asymmetric spacing of the other cutting teeth will not induce harmonics, which prevents the tool from creating chatter.

The red dimples indicate which two opposing teeth are the measuring teeth. All S.C.A.M.I. Reamers have a dimple to indicate the 180° opposing teeth.

### Where to Take the Measurement

When measuring the diameter, take the measurement from the area of the cutting tooth just below the transition from the lead angle to the OD edge. See the illustration below.

The back side of the OD edge has a back taper. This is why measuring from the location just below the lead angle/OD edge transition point results in the most accurate measurement (before the taper begins).

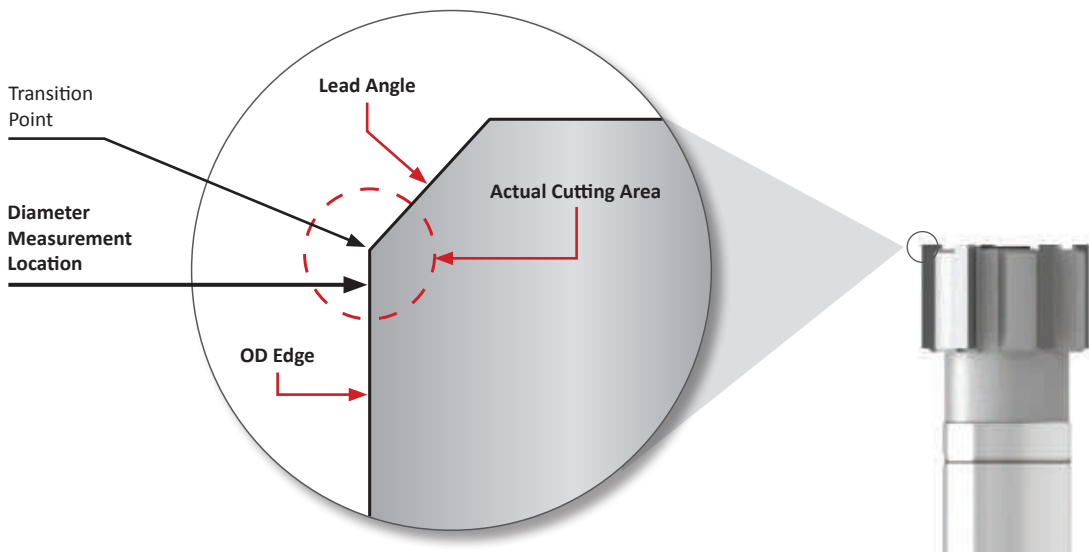

## TIR Measurement

### What is TIR?

Total indicator runout (TIR) refers to the distance to which the reamer is cutting off-center. In an ideal situation, the tool would begin in the exact center of the hole, and it would then rotate and cut in a perfect circle. This would result in a TIR of 0.

Because a perfect TIR of 0 is not practical, the goal is to maintain a TIR as close to 0 as possible. The closer the TIR is to 0, the better the reamer will perform.

Allied Machine recommends a TIR of  $< 0.0005''$  (0.013mm).

Think of attempting to draw a perfect circle with a drafting compass, but the pencil runs slightly outside the point where the circle began because the center point shifted during the pencil's path. This slight area of overlap would be the TIR.

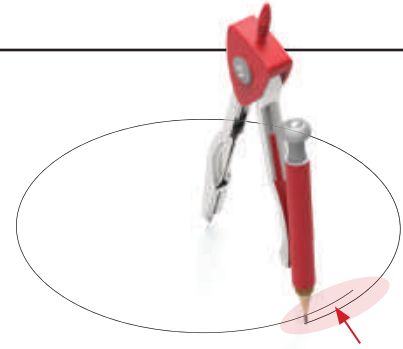

**TIR:** How far from center the tool will move during its path

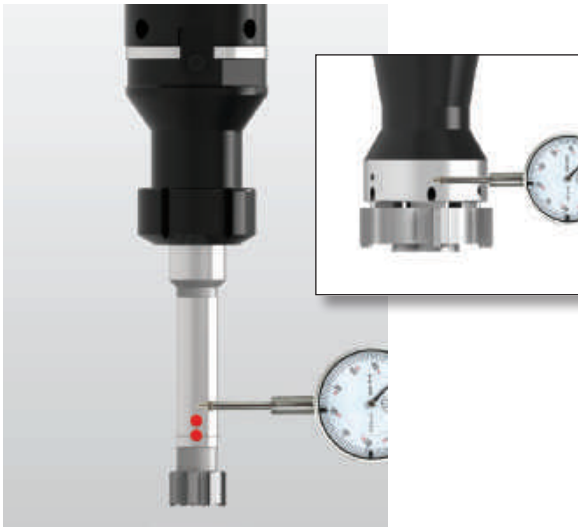

#### Step 1:

Check the TIR first on the mandrel (or ground) area of the reamer. Center the indicator in line with the dimple.

Measure the TIR by rotating the tool until the indicator reaches the highest value.

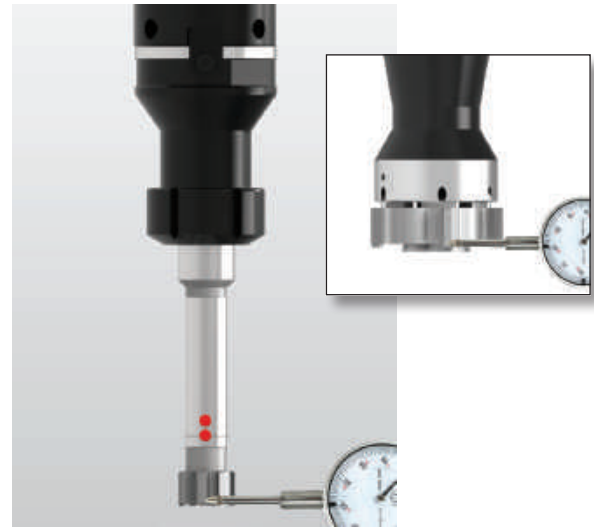

#### Step 2:

Next, check the TIR on the cutting teeth of the reamer.

**NOTE:** Rotate the tool counterclockwise to avoid chipping the cutting teeth with the indicator.

## TIR Adjustment

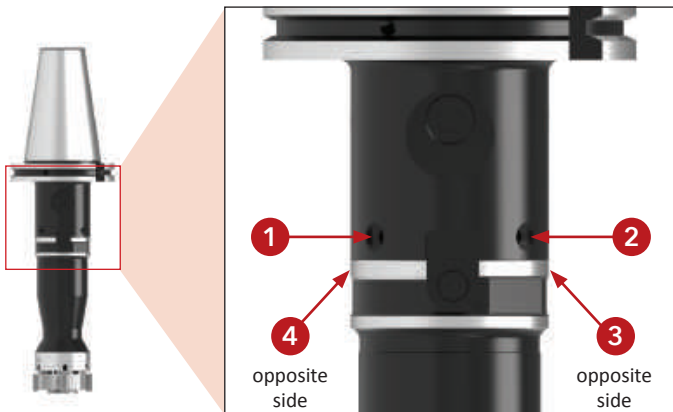

### Step 1:

Place the tool into the machine spindle. Make contact with the 4 radial adjustment screws in a concentric fashion (this results in equal pressure surrounding the tool).

Tighten #1, then #3, followed by #2 and #4.



### Step 2:

Swipe the dial indicator around the ground portion of the arbor near the coolant outlet holes to verify the TIR.

The TIR should be within 0.0005" (as close to 0 as possible). This will ensure the TIR check on the cutting teeth will be more true. It also means the arbor is running true to the shank.

### Step 3:

Once the TIR is checked on the arbor, check the TIR on the cutting teeth. Rotate the tool counterclockwise to avoid chipping the cutting teeth.

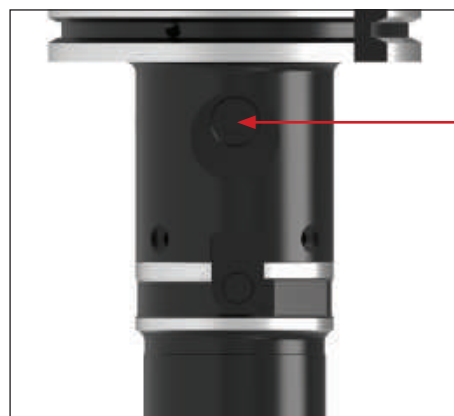

Clamping Screw

### Step 4:

Tighten down the central clamping screws. During the tightening, the tool body will shift slightly. Repeat the TIR check on the cutting teeth, and adjust as necessary.

A

DRILLING

B

BORING

C

REAMING

D

BURNISHING

E

THREADING

X

SPECIALS

## Troubleshooting Guide

A  
DRILLING  
B  
BORING  
C  
REAMING  
D  
BURNISHING  
E  
THREADING  
X  
SPECIALS

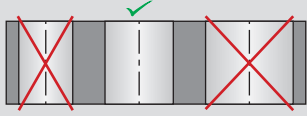

### Oversized Hole

- Reamer is running eccentric to the center of the machine spindle ▶ Use modular system with radial adjustment
- Excessive misalignment causing reamer to cut on back taper ▶ Fix the misalignment
- Material build up on cutting edges ▶ Replace the coolant or change the cutting speed
- Reamer diameter is too large ▶ Use smaller reamer or regrind existing reamer

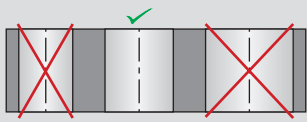

### Undersized Hole

- The reamer diameter is too small ▶ Use larger reamer
- The reamer diameter is worn ▶ Expand, regrind, or replace the reamer
- The coolant is not suitable ▶ Replace the coolant
- Stock allowance is too small ▶ Increase the stock allowance
- The cutting speed is too low ▶ Increase the cutting speed

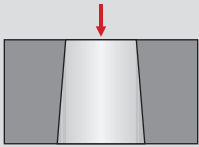

### Tapered Hole

- Excessive misalignment ▶ Correct the misalignment

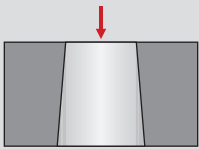

### Burr at Hole Entry

- Excessive misalignment ▶ Correct the misalignment

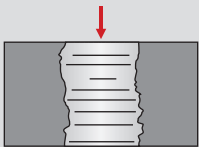

### Hole is Not Straight

- Concentricity and alignment error between the workpiece and the tool ▶ Correct the misalignment and use the modular system with radial adjustment
- Asymmetrical cutting or angled surfaces ▶ Create a chamfer on the lead-in

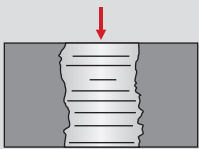

### Poor Hole Finish

- One cutting edge is chipped ▶ Regrind the reamer
- The lead-in is irregular ▶ Regrind the reamer
- Back taper on the cutting edge is too great ▶ Regrind the reamer
- Excessive misalignment ▶ Correct the misalignment or use the modular system
- Cutting data is not correct ▶ Verify the cutting data
- Poor chip evacuation ▶ Verify the coolant volume and pressure or use through tool coolant

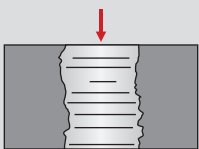

### Reamer Creates Excessive Torque Loading

- Back taper on the cutting edge is too small ▶ Regrind the reamer
- The radially ground land is too wide ▶ Regrind the reamer
- The coolant is not suitable ▶ Replace the coolant





SECTION

---

D

---

Burnishing

# Roller Burnishing Systems

Through Hole Style | Blind Hole Style



## Get the Finish You Need

Allied Machine is proud to offer roller burnishing tools from S.C.A.M.I.®. These hole finishing tools provide extremely high-quality surface finish on both through hole and blind hole applications. With roller burnishing, you can eliminate the need for slower and more costly finishing processes and secondary operations such as grinding, honing, and lapping.

Not only will the roller burnishing tools create a smooth surface finish, but they will also harden the material and increase the wear resistance of the part. The benefits of this single operation result in the hole quality you should expect from Allied Machine.

Creates fine surface finishes	Increases wear and corrosion resistance	Eliminates other processes and saves you money
-------------------------------	---	--

## Applicable Industries

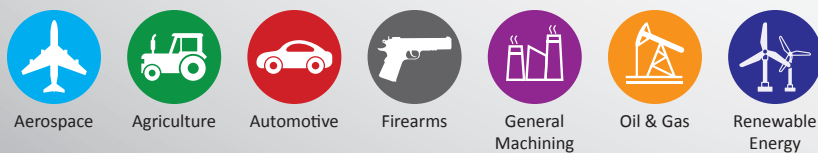

Your safety and the safety of others is very important. This catalog contains important safety messages. Always read and follow all safety precautions.



This triangle is a safety hazard symbol. It alerts you to potential safety hazards that can cause tool failure and serious injury.

When you see this symbol in the catalog, look for a related safety message that may be near this triangle or referred to in the nearby text.

There are safety signal words also used in the catalog. Safety messages follow these words.

### **WARNING**

**WARNING** (shown above) means that failure to follow the precautions in this message could result in tool failure and serious injury.

**NOTICE** means that failure to follow the precautions in this message could result in damage to the tool or machine but not result in personal injury.

**NOTE** and **IMPORTANT** are also used. These are important that you read and follow but are not safety-related.

Visit [www.alliedmachine.com](http://www.alliedmachine.com) for the most up-to-date information and procedures.



# Roller Burnishing Systems Contents

## Reference Icons

The following icons will appear throughout the catalog to help you navigate between products.



### Technical Information

Detailed instructions and information regarding the corresponding part(s)

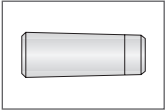

### Through Hole Rolls

Refers to the rolls available for through hole burnishing tools

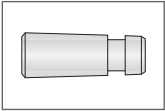

### Blind Hole Rolls

Refers to the rolls available for blind hole burnishing tools

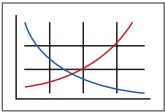

### Recommended Cutting Data

Speed and feed recommendations for optimum and safe burnishing

Series	Diameter Range	
	Imperial (inch)	Metric (mm)
H	0.1555 - 0.5028	3.95 - 12.77
I	0.4976 - 0.6634	12.64 - 16.85
K	0.6535 - 0.9740	16.60 - 24.74
L	0.9661 - 1.2268	24.54 - 31.16
F	0.9661 - 1.2268	24.54 - 31.16
M	1.2146 - 1.4118	30.85 - 35.86
N	1.4020 - 1.8492	35.61 - 46.97
O	1.8390 - 2.2240	46.71 - 56.49
P	2.2138 - 2.7240	56.23 - 69.19
Q	2.7138 - 3.3492	68.93 - 85.07
R	3.3390 - 4.0992	84.81 - 104.12
S	4.0890 - 5.0370	103.86 - 127.94
T	5.0354 - 5.9016	127.90 - 149.90
U	5.9016 - 6.5315	149.90 - 165.90



Allied Machine & Engineering offers Roller Burnishing tools through an exclusive supply agreement with S.C.A.M.I. s.n.c.

S.C.A.M.I. is an Italian manufacturer that has been producing high quality cutting tools for over 40 years.

Visit [www.alliedmachine.com](http://www.alliedmachine.com) for additional information about all Allied Machine products, or contact our Application Engineering department for technical assistance.

## Introduction Information

Roller Burnishing Overview . . . . .	2 - 3
Product Offering . . . . .	4
Product Selection Guide . . . . .	5
Product Nomenclature . . . . .	6

## Burnishing Series

H Series . . . . .	7 - 11
I Series . . . . .	12 - 13
K Series . . . . .	14 - 15
L Series . . . . .	16 - 17
F Series . . . . .	18 - 19
M Series . . . . .	20 - 21
N Series . . . . .	22 - 23
O Series . . . . .	24 - 25
P Series . . . . .	26 - 27
Q Series . . . . .	28 - 29
R Series . . . . .	30 - 31
S Series . . . . .	32 - 33
T Series . . . . .	34 - 35
U Series . . . . .	36 - 37

Rolls . . . . .	38 - 39
-----------------	---------

## Technical Information

Diameter Adjustment . . . . .	40
How the Burnisher Works . . . . .	41

## Recommended Cutting Data

Imperial (inch) . . . . .	42 - 43
Metric (mm) . . . . .	44 - 45

## Roller Burnishing Overview

### The Principle of Roller Burnishing

Roller burnishing is a cold-working process that produces a fine surface finish. The planetary rotation of the hardened rolls creates pressure over a metal surface. Unlike cold rolling, which produces large sectional changes, roller burnishing involves cold-working on the surface of the workpiece to improve the surface structure.

All machined surfaces consist of a series of peaks and valleys, all having irregular height and spacing. The plastic deformation created by roller burnishing is a displacement of the material in the peaks. When under pressure, the material in the peaks flows into the valleys. During the process, tool marks and irregularities are rolled out, resulting in a mirror-like finish with a tough, work-hardened surface that is also wear and corrosion resistant.

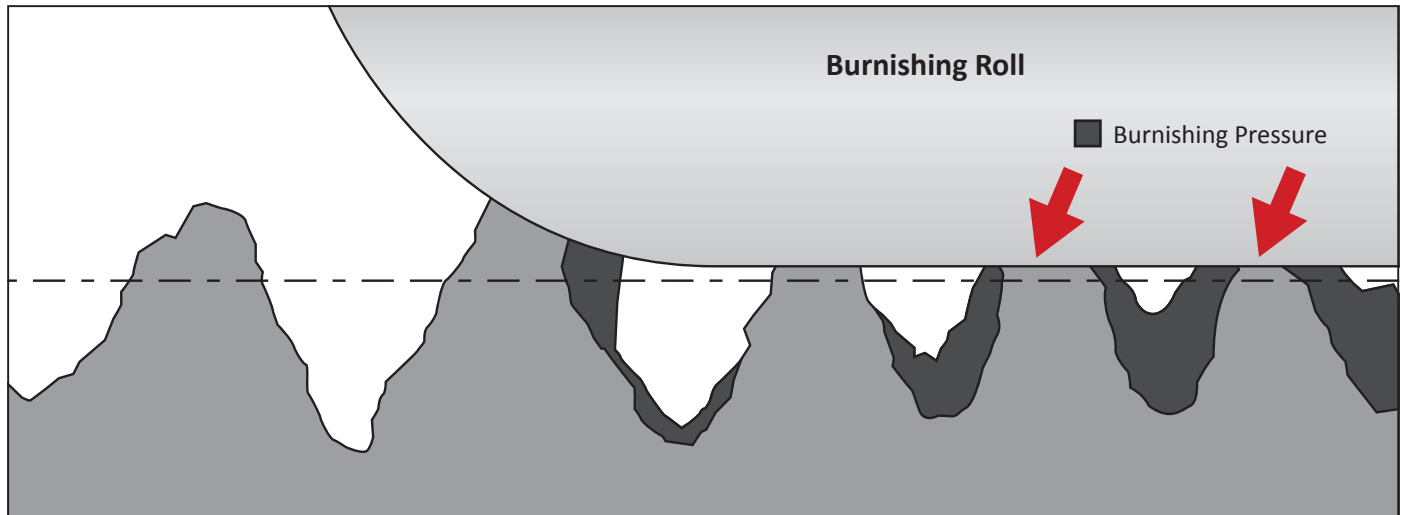

#### Advantages of Roller Burnishing: Metallurgical Properties

- Grain structure is condensed and refined.
- The compacted surface is **smoother, harder, and more wear resistant** than ground or honed surfaces.
- The process reduces surface porosity and also removes scratches that could hold reactive substances or contaminants. **This increases the corrosion resistance.**
- Depending on the material, the surface hardness can be **increased by as much as 10 points Rockwell C**. This may eliminate the need for heat treatment.
- The plastic deformation induces residual compressive stresses in the surface of the part. This increases the strength properties and fatigue life of the part because any forces on the part must overcome these residual stresses, as well as the tensile strength of the materials, before fatigue conditions occur.

#### Advantages of Roller Burnishing: Surface Finish

- Creates a high finish to any machinable metal.
- Surfaces that are bored, reamed, or turned to 125 micro inches or more can be finished to 4 micro inch CLA or less in one pass (at feed rates of 125 to 300 mm/min).
- Roller burnishing replaces grinding, honing, lapping, and other expensive secondary operations.
- Tool marks are rolled out.

### The Process

- The first contact with the machined surface occurs in Section A.
- Plastic deformation occurs in Section B as the yield point of the surface is exceeded.
- Section D is the pressurized depth.
- Once the material endures the maximum compressive strain (Section C), it starts relieving elastically (Section E) through the finishing zone.
- This leaves a smooth surface and a compressive residual stress of significant peak value.
- The stresses formed on the material during the compression decrease toward the center. These stresses reach approximately 1mm below the surface. This increases the surface hardness.

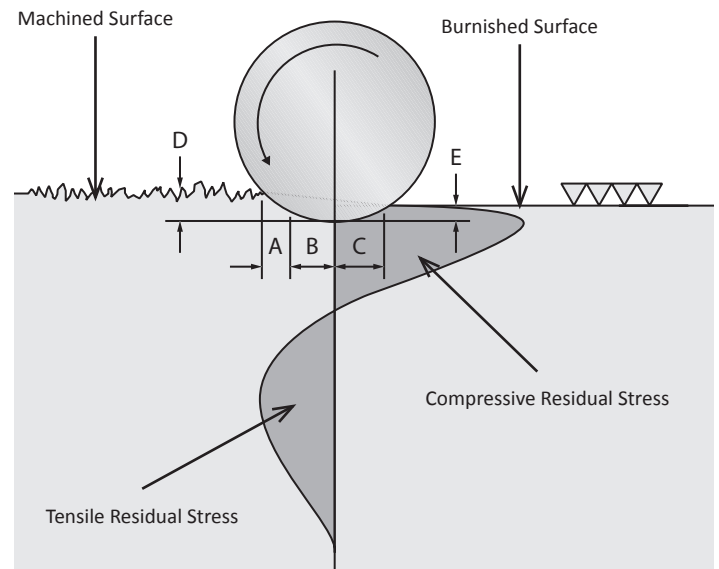

## Roller Burnishing Overview

### When to Roller Burnish

#### Conditions for Roller Burnishing

Roller burnishing is a cold working process used to achieve fine hole finishes. In order to achieve the most optimal results, adhere to the benchmarks below:

- **Finishing:** The ductility and hardness of the workpiece material along with the surface preparation dictates the quality of the burnished finish.
- **Workability:** Any ductile and malleable material up to RC40 can be roller burnished.
- **Worked Surface Properties:** Workpieces with an interrupted surface within 10% of the circumference can be successfully burnished with a standard tool (see Figures 1 and 2).

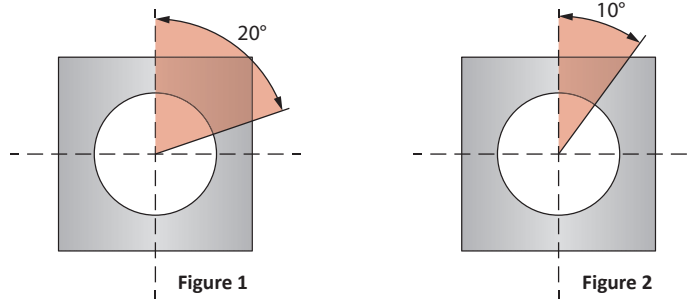

- **Tolerance of the Burnished Piece:** The tolerance range achieved from the burnishing will be equal to that achieved from the pre-machining since no material will be removed.

The ideal surface for burnishing consists of a succession of peaks. These peaks correspond on regular feed of the preparation tool (see Figure 3). We suggest the ALVAN® expandable reamer for pre-burnishing because it creates a uniform roughness and a tolerance range of H6 - H7.

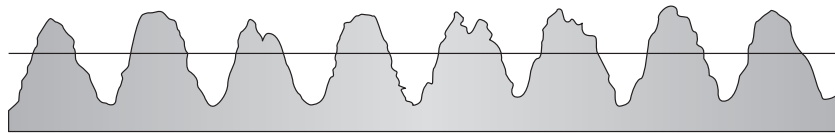

Figure 3

Pre-machining tapers and surface irregularities caused by cutting tool failure must be noted because these conditions cannot be corrected by the roller burnishing process (see Figures 4 and 5).

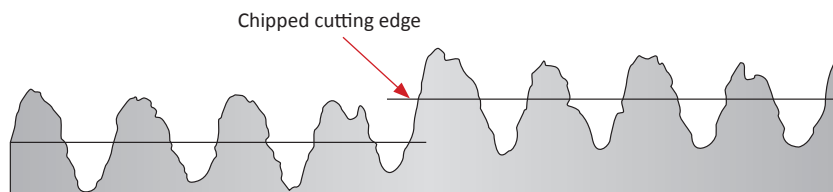

Figure 4

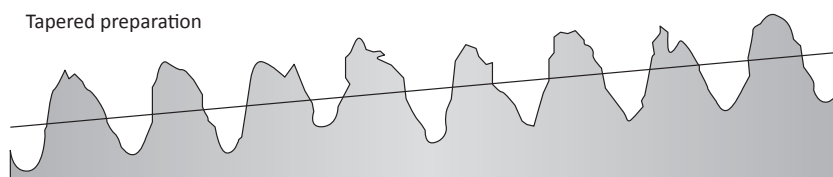

Figure 5

## Product Offering



**Through Hole Style**

0.1555" - 6.5313" (3.95mm - 165.90mm)



**Blind Hole Style**

0.1850" - 6.5313" (4.70mm - 165.90mm)

### *Advantages* of the Roller Burnishing Tool

- ✔ **Provides accurate size control**  
 tolerances within 0.0005" or better (depending on variables such as material)
- ✔ **Produces fine surface finishes**  
 between 1 - 10 microinches Ra
- ✔ **Increases surface hardness**  
 by 5 - 10% or more
- ✔ **Performs a much cleaner operation**  
 than honing or other abrasive finishing methods
- ✔ **Provides versatility**  
 because the operation can be performed on any rotating spindle
- ✔ **Eliminates the need for slower and costly finishing processes and secondary operations**  
 such as grinding, honing, lapping, etc.

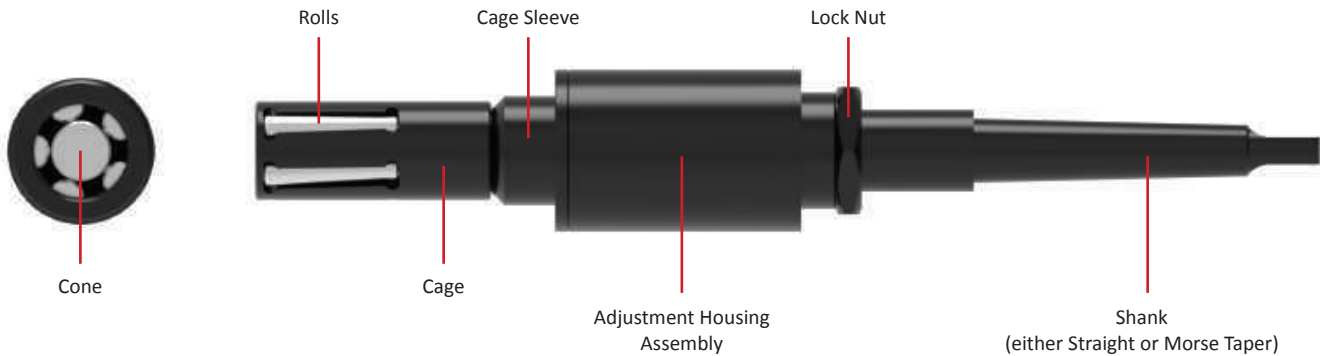

#### The Tool Components

All roller burnishing tools (both through hole and blind hole) are composed of the basic burnisher assembly, including:

- Cage
- Cone
- Rolls
- Shank (either straight or Morse Taper)

## Product Selection Guide

Series	Diameter Range (inch / mm)						Length				
	0 - 1	1 - 2	2 - 3	3 - 4	4 - 5	5 - 6	6 - 7	Short	Standard	Long	Unlimited
	0 - 25.4	25.4 - 50.8	50.8 - 76.2	76.2 - 101.6	101.6 - 127	127 - 152.4	152.4 - 177.8				
H*	█							✓	✓	✓	
I	█							✓	✓	✓	
K		█						✓	✓	✓	
L		█						✓	✓	✓	
F		█									✓
M		█									✓
N			█								✓
O			█								✓
P			█								✓
Q				█							✓
R				█							✓
S					█						✓
T						█					✓
U							█				✓

\*For H series: through hole tools start at 0.1555" (3.95mm) and blind hole tools start at 0.1850" (4.70mm)

### When to **ORDER UP**

In some cases, there will be a diameter overlap between a series and the series after it. If the diameter you need falls into this overlap, choose the higher of the two series.

**Example:**

You need a 24.64mm diameter tool. This diameter falls into both the K series and the L series.

- K series diameter range = 16.60mm - 24.74mm
- L series diameter range = 24.54mm - 31.16mm

In this scenario, you would choose the L series tool that covers the 24.64 diameter.

## Product Nomenclature

### Roller Burnishing Tools

<b>RDK</b>	<b>H</b>	-	<b>2</b>	<b>1</b>	<b>0</b>	-	<b>004,70</b>
1	2		3	4	5		6

<b>1. Type of Burnisher</b> RDK = Through holes RSK = Blind holes	<b>2. Series</b> H = H series    F = F series    P = P series    T = T series I = I series    M = M series    Q = Q series    U = U series K = K series    N = N series    R = R series L = L series    O = O series    S = S series	<b>3. Shank Type</b> 1 = Straight 2 = Morse Taper
<b>4. Length</b> 0 = Unlimited 1 = Short 2 = Standard 3 = Long	<b>5. Cage Style</b> 0 = Standard	<b>6. Diameter</b> Through Hole Tools = Minimum diameter of burnishing range Blind Hole Tools = Diameter to burnish

### Cone Reduction Factor (Blind Holes)

When burnishing blind holes, the cone must not extend past the end of the rolls. If it does, the cone will collide with the bottom of the hole. Each burnishing tool has an adjustment range of:

- Approximately 0.5mm on diameter for tools below 12.7mm
- Approximately 1.0mm on diameter for tools above 12.7mm

For through hole burnishing tools, the standard cone value "x" is 1. If the standard cone is used for blind hole burnishing, the only way it will not extend past the end of the rolls is to reduce the length of the cone. The required length reduction is dependent on the set diameter versus the minimum capable diameter of the tool. The factor of reduction (x) can be calculated using the formulas below and will be a whole integer number ranging from 2 - 8.

The "x" value could result in a decimal figure. If so, round down for answers below 0.60, and round up for answers 0.61 and above.

<b>Diameter (5.89mm - 12.77mm)</b> $x = 1 + \frac{Z - Y}{0.05}$ Z = diameter of the hole Y = minimum diameter setting of tool <b>Example:</b> Z = 11.05 Y = 10.71mm $x = 1 + \frac{11.05 - 10.71}{0.05} = 7.8$ which is approximated at "x" = 8 <b>Correct Cone:</b> RSTH-038-11025	<b>Diameter (12.64mm - 127.94mm)</b> $x = 1 + \frac{Z - Y}{0.10}$ Z = diameter of the hole Y = minimum diameter setting of tool <b>Example:</b> Z = 17.76 Y = 17.40mm $x = 1 + \frac{17.76 - 17.40}{0.10} = 4.6$ which is approximated at "x" = 4 <b>Correct Cone:</b> RSTK-034-00044	<b>Diameter (127.90mm - 165.90mm)</b> $x = 1 + \frac{Z - Y}{0.10}$ Z = diameter of the hole Y = minimum diameter setting of tool <b>Example:</b> Z = 148.20 Y = 147.90mm $xx = 31 + \frac{148.20 - 147.90}{0.10} = 34$ <b>Correct Cone:</b> RSTT-034-01480
--	--	--

### Reference Key

Symbol	Attribute
D <sub>1</sub>	Diameter range
L <sub>2</sub>	Burnishing length
L <sub>3</sub>	Reference length

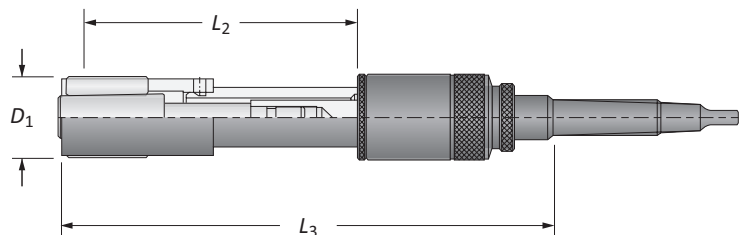



## Roller Burnishing Tools | Through Holes

H Series (mini) | Diameter Range: 0.1555" - 0.1870" (3.95mm - 4.75mm)

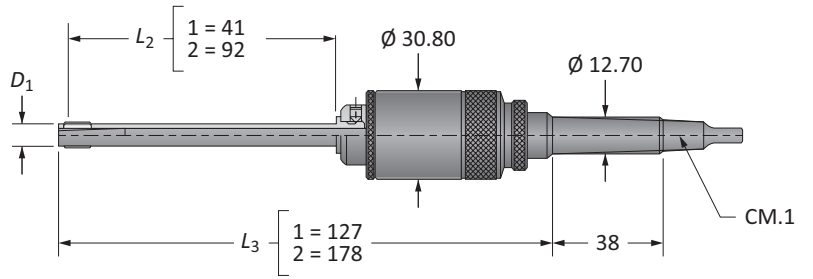

D <sub>1</sub>		L	Part No.		Spare Parts			Qty Rolls
Imperial (in)	Metric (mm)		Assembly with Morse Taper Shank	Assembly with Straight Shank	Cage	Cone	Rolls	
0.1555 - 0.1634	3.95 - 4.15	1	RDKH-212-00395	RDKH-112-00395	RDCH-012-10005	RDTH-031-10012	RDRY-704-00047	3
0.1555 - 0.1634	3.95 - 4.15	2	RDKH-222-00395	RDKH-122-00395	RDCH-012-20005	RDTH-031-20012	RDRY-704-00047	3
0.1638 - 0.1713	4.16 - 4.35	1	RDKH-212-00416	RDKH-112-00416	RDCH-012-10006	RSTH-035-10012	RDRY-704-00047	3
0.1638 - 0.1713	4.16 - 4.35	2	RDKH-222-00416	RDKH-122-00416	RDCH-012-20006	RSTH-035-20012	RDRY-704-00047	3
0.1717 - 0.1791	4.36 - 4.55	1	RDKH-212-00436	RDKH-112-00436	RDCH-012-10007	RDTH-031-10013	RDRY-704-00047	3
0.1717 - 0.1791	4.36 - 4.55	2	RDKH-222-00436	RDKH-122-00436	RDCH-012-20007	RDTH-031-20013	RDRY-704-00047	3
0.1795 - 0.1870	4.56 - 4.75	1	RDKH-212-00456	RDKH-112-00456	RDCH-012-10008	RSTH-035-10013	RDRY-704-00047	3
0.1795 - 0.1870	4.56 - 4.75	2	RDKH-222-00456	RDKH-122-00456	RDCH-012-20008	RSTH-035-20013	RDRY-704-00047	3

**NOTE:** Each roller burnishing tool comes assembled complete with cage, cone, and rolls.

Key on D: 1

D: 42 - 45

D: 40 - 41

D: 38

## Roller Burnishing Tools | Through Holes

H Series | Diameter Range: 0.1850" - 0.5028" (4.70mm - 12.77mm)

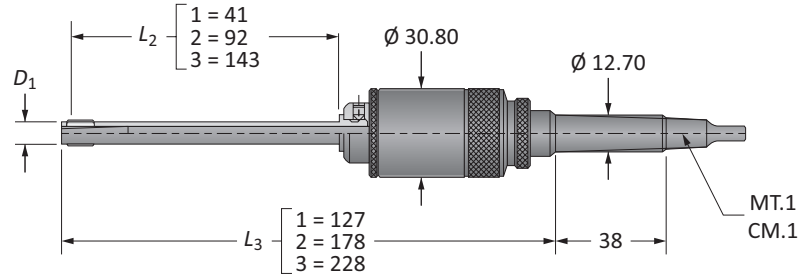

$D_1$		$L$	Part No.		Spare Parts			Qty Rolls
Imperial (in)	Metric (mm)		Assembly with Morse Taper Shank	Assembly with Straight Shank	Cage	Cone	Rolls	
0.1850 - 0.1929	4.70 - 4.90	1	RDKH-210-00470	RDKH-110-00470	RDCH-011-10012	RDTH-031-10012	RDRY-704-00062	3
0.1850 - 0.1929	4.70 - 4.90	2	RDKH-220-00470	RDKH-120-00470	RDCH-011-20012	RDTH-031-20012	RDRY-704-00062	3
0.1850 - 0.1929	4.70 - 4.90	3	RDKH-230-00470	RDKH-130-00470	RDCH-011-30012	RDTH-031-30012	RDRY-704-00062	3
0.1917 - 0.2035	4.87 - 5.17	1	RDKH-210-00487	RDKH-110-00487	RDCH-011-10011	RSTH-033-10012	RDRY-704-00062	3
0.1917 - 0.2035	4.87 - 5.17	2	RDKH-220-00487	RDKH-120-00487	RDCH-011-20011	RSTH-033-20012	RDRY-704-00062	3
0.1917 - 0.2035	4.87 - 5.17	3	RDKH-230-00487	RDKH-130-00487	RDCH-011-30011	RSTH-033-30012	RDRY-704-00062	3
0.1996 - 0.2200	5.07 - 5.59	1	RDKH-210-00507	RDKH-110-00507	RDCH-011-10013	RDTH-031-10013	RDRY-704-00062	5
0.1996 - 0.2200	5.07 - 5.59	2	RDKH-220-00507	RDKH-120-00507	RDCH-011-20013	RDTH-031-20013	RDRY-704-00062	5
0.1996 - 0.2200	5.07 - 5.59	3	RDKH-230-00507	RDKH-130-00507	RDCH-011-30013	RDTH-031-30013	RDRY-704-00062	5
0.2161 - 0.2358	5.49 - 5.99	1	RDKH-210-00549	RDKH-110-00549	RDCH-011-10014	RDTH-031-10013	RDRY-704-00070	5
0.2161 - 0.2358	5.49 - 5.99	2	RDKH-220-00549	RDKH-120-00549	RDCH-011-20014	RDTH-031-20013	RDRY-704-00070	5
0.2161 - 0.2358	5.49 - 5.99	3	RDKH-230-00549	RDKH-130-00549	RDCH-011-30014	RDTH-031-30013	RDRY-704-00070	5
0.2319 - 0.2524	5.89 - 6.41	1	RDKH-210-00589	RDKH-110-00589	RDCH-011-10015	RDTH-031-10015	RDRY-704-00070	5
0.2319 - 0.2524	5.89 - 6.41	2	RDKH-220-00589	RDKH-120-00589	RDCH-011-20015	RDTH-031-20015	RDRY-704-00070	5
0.2319 - 0.2524	5.89 - 6.41	3	RDKH-230-00589	RDKH-130-00589	RDCH-011-30015	RDTH-031-30015	RDRY-704-00070	5
0.2484 - 0.2681	6.31 - 6.81	1	RDKH-210-00631	RDKH-110-00631	RDCH-011-10016	RDTH-031-10015	RDRY-704-00078	5
0.2484 - 0.2681	6.31 - 6.81	2	RDKH-220-00631	RDKH-120-00631	RDCH-011-20016	RDTH-031-20015	RDRY-704-00078	5
0.2484 - 0.2681	6.31 - 6.81	3	RDKH-230-00631	RDKH-130-00631	RDCH-011-30016	RDTH-031-30015	RDRY-704-00078	5
0.2642 - 0.2839	6.71 - 7.21	1	RDKH-210-00671	RDKH-110-00671	RDCH-011-10017	RDTH-031-10017	RDRY-704-00078	5
0.2642 - 0.2839	6.71 - 7.21	2	RDKH-220-00671	RDKH-120-00671	RDCH-011-20017	RDTH-031-20017	RDRY-704-00078	5
0.2642 - 0.2839	6.71 - 7.21	3	RDKH-230-00671	RDKH-130-00671	RDCH-011-30017	RDTH-031-30017	RDRY-704-00078	5
0.2803 - 0.3000	7.12 - 7.62	1	RDKH-210-00712	RDKH-110-00712	RDCH-011-10018	RDTH-031-10017	RDRY-704-00086	5
0.2803 - 0.3000	7.12 - 7.62	2	RDKH-220-00712	RDKH-120-00712	RDCH-011-20018	RDTH-031-20017	RDRY-704-00086	5
0.2803 - 0.3000	7.12 - 7.62	3	RDKH-230-00712	RDKH-130-00712	RDCH-011-30018	RDTH-031-30017	RDRY-704-00086	5
0.2945 - 0.3142	7.48 - 7.98	1	RDKH-210-00748	RDKH-110-00748	RDCH-011-10019	RDTH-031-10019	RDRY-704-00086	5
0.2945 - 0.3142	7.48 - 7.98	2	RDKH-220-00748	RDKH-120-00748	RDCH-011-20019	RDTH-031-20019	RDRY-704-00086	5
0.2945 - 0.3142	7.48 - 7.98	3	RDKH-230-00748	RDKH-130-00748	RDCH-011-30019	RDTH-031-30019	RDRY-704-00086	5
0.3102 - 0.3299	7.88 - 8.38	1	RDKH-210-00788	RDKH-110-00788	RDCH-011-10020	RDTH-031-10019	RDRY-704-00093	5
0.3102 - 0.3299	7.88 - 8.38	2	RDKH-220-00788	RDKH-120-00788	RDCH-011-20020	RDTH-031-20019	RDRY-704-00093	5
0.3102 - 0.3299	7.88 - 8.38	3	RDKH-230-00788	RDKH-130-00788	RDCH-011-30020	RDTH-031-30019	RDRY-704-00093	5
0.3260 - 0.3461	8.28 - 8.79	1	RDKH-210-00828	RDKH-110-00828	RDCH-011-10021	RDTH-031-10021	RDRY-704-00093	5
0.3260 - 0.3461	8.28 - 8.79	2	RDKH-220-00828	RDKH-120-00828	RDCH-011-20021	RDTH-031-20021	RDRY-704-00093	5
0.3260 - 0.3461	8.28 - 8.79	3	RDKH-230-00828	RDKH-130-00828	RDCH-011-30021	RDTH-031-30021	RDRY-704-00093	5

**NOTE:** Each roller burnishing tool comes assembled complete with cage, cone, and rolls.

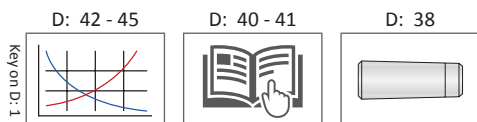





## Roller Burnishing Tools | Through Holes (continued)

H Series | Diameter Range: 0.1850" - 0.5028" (4.70mm - 12.77mm)

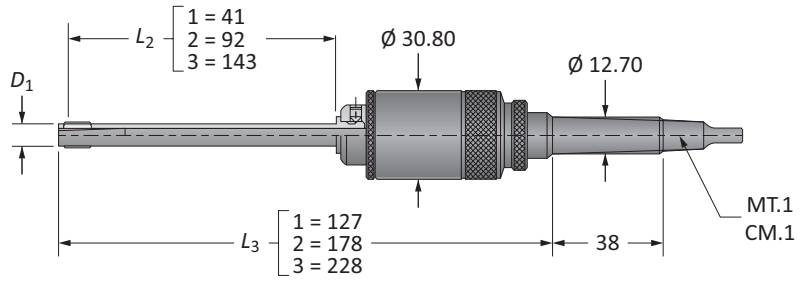

D <sub>1</sub>		L	Part No.		Spare Parts			Qty Rolls
Imperial (in)	Metric (mm)		Assembly with Morse Taper Shank	Assembly with Straight Shank	Cage	Cone	Rolls	
0.3410 - 0.3606	8.66 - 9.16	1	RDKH-210-00866	RDKH-110-00866	RDCH-011-10022	RDTH-031-10019	RDRY-704-00109	5
0.3410 - 0.3606	8.66 - 9.16	2	RDKH-220-00866	RDKH-120-00866	RDCH-011-20022	RDTH-031-20019	RDRY-704-00109	5
0.3410 - 0.3606	8.66 - 9.16	3	RDKH-230-00866	RDKH-130-00866	RDCH-011-30022	RDTH-031-30019	RDRY-704-00109	5
0.3567 - 0.3768	9.06 - 9.57	1	RDKH-210-00906	RDKH-110-00906	RDCH-011-10023	RDTH-031-10021	RDRY-704-00109	5
0.3567 - 0.3768	9.06 - 9.57	2	RDKH-220-00906	RDKH-120-00906	RDCH-011-20023	RDTH-031-20021	RDRY-704-00109	5
0.3567 - 0.3768	9.06 - 9.57	3	RDKH-230-00906	RDKH-130-00906	RDCH-011-30023	RDTH-031-30021	RDRY-704-00109	5
0.3732 - 0.3933	9.48 - 9.99	1	RDKH-210-00948	RDKH-110-00948	RDCH-011-10024	RDTH-031-10024	RDRY-704-00109	5
0.3732 - 0.3933	9.48 - 9.99	2	RDKH-220-00948	RDKH-120-00948	RDCH-011-20024	RDTH-031-20024	RDRY-704-00109	5
0.3732 - 0.3933	9.48 - 9.99	3	RDKH-230-00948	RDKH-130-00948	RDCH-011-30024	RDTH-031-30024	RDRY-704-00109	5
0.3902 - 0.4102	9.91 - 10.42	1	RDKH-210-00991	RDKH-110-00991	RDCH-011-10025	RDTH-031-10025	RDRY-704-00109	5
0.3902 - 0.4102	9.91 - 10.42	2	RDKH-220-00991	RDKH-120-00991	RDCH-011-20025	RDTH-031-20025	RDRY-704-00109	5
0.3902 - 0.4102	9.91 - 10.42	3	RDKH-230-00991	RDKH-130-00991	RDCH-011-30025	RDTH-031-30025	RDRY-704-00109	5
0.4051 - 0.4252	10.29 - 10.80	1	RDKH-210-01029	RDKH-110-01029	RDCH-011-10026	RDTH-031-10024	RDRY-704-00125	5
0.4051 - 0.4252	10.29 - 10.80	2	RDKH-220-01029	RDKH-120-01029	RDCH-011-20026	RDTH-031-20024	RDRY-704-00125	5
0.4051 - 0.4252	10.29 - 10.80	3	RDKH-230-01029	RDKH-130-01029	RDCH-011-30026	RDTH-031-30024	RDRY-704-00125	5
0.4217 - 0.4413	10.71 - 11.21	1	RDKH-210-01071	RDKH-110-01071	RDCH-011-10027	RDTH-031-10025	RDRY-704-00125	5
0.4217 - 0.4413	10.71 - 11.21	2	RDKH-220-01071	RDKH-120-01071	RDCH-011-20027	RDTH-031-20025	RDRY-704-00125	5
0.4217 - 0.4413	10.71 - 11.21	3	RDKH-230-01071	RDKH-130-01071	RDCH-011-30027	RDTH-031-30025	RDRY-704-00125	5
0.4374 - 0.4571	11.11 - 11.61	1	RDKH-210-01111	RDKH-110-01111	RDCH-011-10028	RDTH-031-10028	RDRY-704-00125	5
0.4374 - 0.4571	11.11 - 11.61	2	RDKH-220-01111	RDKH-120-01111	RDCH-011-20028	RDTH-031-20028	RDRY-704-00125	5
0.4374 - 0.4571	11.11 - 11.61	3	RDKH-230-01111	RDKH-130-01111	RDCH-011-30028	RDTH-031-30028	RDRY-704-00125	5
0.4512 - 0.4709	11.46 - 11.96	1	RDKH-210-01146	RDKH-110-01146	RDCH-011-10029	RDTH-031-10024	RDRY-704-00148	5
0.4512 - 0.4709	11.46 - 11.96	2	RDKH-220-01146	RDKH-120-01146	RDCH-011-20029	RDTH-031-20024	RDRY-704-00148	5
0.4512 - 0.4709	11.46 - 11.96	3	RDKH-230-01146	RDKH-130-01146	RDCH-011-30029	RDTH-031-30024	RDRY-704-00148	5
0.4681 - 0.4878	11.89 - 12.39	1	RDKH-210-01189	RDKH-110-01189	RDCH-011-10030	RDTH-031-10025	RDRY-704-00148	5
0.4681 - 0.4878	11.89 - 12.39	2	RDKH-220-01189	RDKH-120-01189	RDCH-011-20030	RDTH-031-20025	RDRY-704-00148	5
0.4681 - 0.4878	11.89 - 12.39	3	RDKH-230-01189	RDKH-130-01189	RDCH-011-30030	RDTH-031-30025	RDRY-704-00148	5
0.4831 - 0.5028	12.27 - 12.77	1	RDKH-210-01227	RDKH-110-01227	RDCH-011-10031	RDTH-031-10028	RDRY-704-00148	5
0.4831 - 0.5028	12.27 - 12.77	2	RDKH-220-01227	RDKH-120-01227	RDCH-011-20031	RDTH-031-20028	RDRY-704-00148	5
0.4831 - 0.5028	12.27 - 12.77	3	RDKH-230-01227	RDKH-130-01227	RDCH-011-30031	RDTH-031-30028	RDRY-704-00148	5

**NOTE:** Each roller burnishing tool comes assembled complete with cage, cone, and rolls.

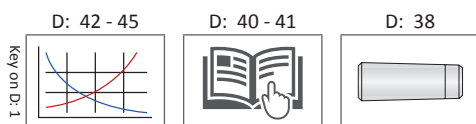

H  
A  
DRILLING  
B  
BORING  
C  
REAMING  
D  
BURNISHING  
E  
THREADING  
X  
SPECIALS

**Roller Burnishing Tools | Blind Holes**

H Series | Diameter Range: 0.2319" - 0.5028" (5.89mm - 12.77mm)

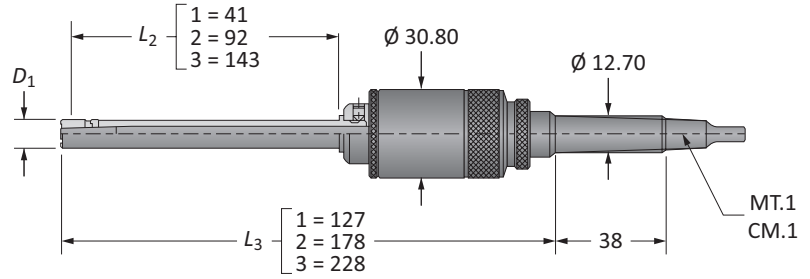

D <sub>1</sub>		L	Part No.*		Spare Parts				Qty Rolls
Imperial (in)	Metric (mm)		Assembly with Morse Taper Shank	Assembly with Straight Shank	Cage	Cone**	Rolls		
0.2319 - 0.2524	5.89 - 6.41	1	RSKH-210-xxxxx	RSKH-110-xxxxx	RSCH-015-10015	RSTH-03x-10012	RSRY-708-00086	3	
0.2319 - 0.2524	5.89 - 6.41	2	RSKH-220-xxxxx	RSKH-120-xxxxx	RSCH-015-20015	RSTH-03x-20012	RSRY-708-00086	3	
0.2319 - 0.2524	5.89 - 6.41	3	RSKH-230-xxxxx	RSKH-130-xxxxx	RSCH-015-30015	RSTH-03x-30012	RSRY-708-00086	3	
0.2484 - 0.2681	6.31 - 6.81	1	RSKH-210-xxxxx	RSKH-110-xxxxx	RSCH-015-10016	RSTH-03x-10013	RSRY-708-00086	3	
0.2484 - 0.2681	6.31 - 6.81	2	RSKH-220-xxxxx	RSKH-120-xxxxx	RSCH-015-20016	RSTH-03x-20013	RSRY-708-00086	3	
0.2484 - 0.2681	6.31 - 6.81	3	RSKH-230-xxxxx	RSKH-130-xxxxx	RSCH-015-30016	RSTH-03x-30013	RSRY-708-00086	3	
0.2642 - 0.2839	6.71 - 7.21	1	RSKH-210-xxxxx	RSKH-110-xxxxx	RSCH-015-10017	RSTH-03x-10015	RSRY-708-00086	3	
0.2642 - 0.2839	6.71 - 7.21	2	RSKH-220-xxxxx	RSKH-120-xxxxx	RSCH-015-20017	RSTH-03x-20015	RSRY-708-00086	3	
0.2642 - 0.2839	6.71 - 7.21	3	RSKH-230-xxxxx	RSKH-130-xxxxx	RSCH-015-30017	RSTH-03x-30015	RSRY-708-00086	3	
0.2803 - 0.3000	7.12 - 7.62	1	RSKH-210-xxxxx	RSKH-110-xxxxx	RSCH-015-10018	RSTH-03x-10017	RSRY-708-00086	3	
0.2803 - 0.3000	7.12 - 7.62	2	RSKH-220-xxxxx	RSKH-120-xxxxx	RSCH-015-20018	RSTH-03x-20017	RSRY-708-00086	3	
0.2803 - 0.3000	7.12 - 7.62	3	RSKH-230-xxxxx	RSKH-130-xxxxx	RSCH-015-30018	RSTH-03x-30017	RSRY-708-00086	3	
0.2945 - 0.3142	7.48 - 7.98	1	RSKH-210-xxxxx	RSKH-110-xxxxx	RSCH-015-10019	RSTH-03x-10019	RSRY-708-00086	3	
0.2945 - 0.3142	7.48 - 7.98	2	RSKH-220-xxxxx	RSKH-120-xxxxx	RSCH-015-20019	RSTH-03x-20019	RSRY-708-00086	3	
0.2945 - 0.3142	7.48 - 7.98	3	RSKH-230-xxxxx	RSKH-130-xxxxx	RSCH-015-30019	RSTH-03x-30019	RSRY-708-00086	3	
0.3102 - 0.3299	7.88 - 8.38	1	RSKH-210-xxxxx	RSKH-110-xxxxx	RSCH-015-10020	RSTH-03x-10021	RSRY-708-00086	3	
0.3102 - 0.3299	7.88 - 8.38	2	RSKH-220-xxxxx	RSKH-120-xxxxx	RSCH-015-20020	RSTH-03x-20021	RSRY-708-00086	3	
0.3102 - 0.3299	7.88 - 8.38	3	RSKH-230-xxxxx	RSKH-130-xxxxx	RSCH-015-30020	RSTH-03x-30021	RSRY-708-00086	3	
0.3260 - 0.3461	8.28 - 8.79	1	RSKH-210-xxxxx	RSKH-110-xxxxx	RSCH-015-10021	RSTH-03x-10024	RSRY-708-00086	3	
0.3260 - 0.3461	8.28 - 8.79	2	RSKH-220-xxxxx	RSKH-120-xxxxx	RSCH-015-20021	RSTH-03x-20024	RSRY-708-00086	3	
0.3260 - 0.3461	8.28 - 8.79	3	RSKH-230-xxxxx	RSKH-130-xxxxx	RSCH-015-30021	RSTH-03x-30024	RSRY-708-00086	3	
0.3410 - 0.3606	8.66 - 9.16	1	RSKH-210-xxxxx	RSKH-110-xxxxx	RSCH-015-10022	RSTH-03x-10015	RSRY-708-00125	3	
0.3410 - 0.3606	8.66 - 9.16	2	RSKH-220-xxxxx	RSKH-120-xxxxx	RSCH-015-20022	RSTH-03x-20015	RSRY-708-00125	3	
0.3410 - 0.3606	8.66 - 9.16	3	RSKH-230-xxxxx	RSKH-130-xxxxx	RSCH-015-30022	RSTH-03x-30015	RSRY-708-00125	3	
0.3567 - 0.3768	9.06 - 9.57	1	RSKH-210-xxxxx	RSKH-110-xxxxx	RSCH-015-10023	RSTH-03x-10017	RSRY-708-00125	3	
0.3567 - 0.3768	9.06 - 9.57	2	RSKH-220-xxxxx	RSKH-120-xxxxx	RSCH-015-20023	RSTH-03x-20017	RSRY-708-00125	3	
0.3567 - 0.3768	9.06 - 9.57	3	RSKH-230-xxxxx	RSKH-130-xxxxx	RSCH-015-30023	RSTH-03x-30017	RSRY-708-00125	3	

\*xxxxx = Indicate to 2 metric decimal places the size to be burnished (e.g. short series roller burnisher Ø 10.25mm with MT.1 shank: RSKH-210-01025).

\*\*x = A number that will vary from 2 to 8 depending upon the exact diameter to be burnished. See page D: 6 for the correct identification of the "x" value.

**NOTE:** Each roller burnishing tool comes assembled complete with cage, cone, and rolls.

D: 42 - 45      D: 40 - 41      D: 39

Key on D: 1



## Roller Burnishing Tools | Blind Holes (continued)

H Series | Diameter Range: 0.2319" - 0.5028" (5.89mm - 12.77mm)

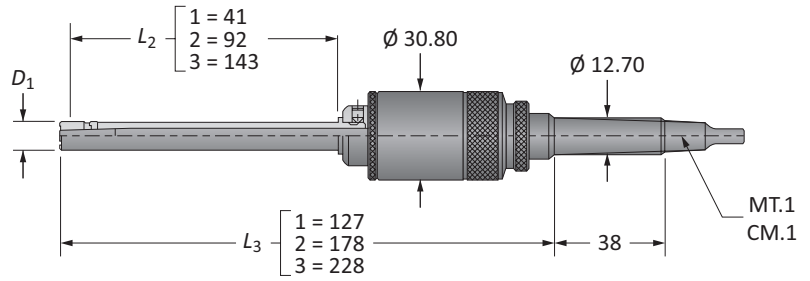

D <sub>1</sub>		L	Part No.*		Spare Parts			Qty Rolls
Imperial (in)	Metric (mm)		Assembly with Morse Taper Shank	Assembly with Straight Shank	Cage	Cone**	Rolls	
0.3732 - 0.3933	9.48 - 9.99	1	RSKH-210-xxxxx	RSKH-110-xxxxx	RSCH-015-10024	RSTH-03x-10019	RSRY-708-00125	3
0.3732 - 0.3933	9.48 - 9.99	2	RSKH-220-xxxxx	RSKH-120-xxxxx	RSCH-015-20024	RSTH-03x-20019	RSRY-708-00125	3
0.3732 - 0.3933	9.48 - 9.99	3	RSKH-230-xxxxx	RSKH-130-xxxxx	RSCH-015-30024	RSTH-03x-30019	RSRY-708-00125	3
0.3902 - 0.4102	9.91 - 10.42	1	RSKH-210-xxxxx	RSKH-110-xxxxx	RSCH-015-10025	RSTH-03x-10021	RSRY-708-00125	3
0.3902 - 0.4102	9.91 - 10.42	2	RSKH-220-xxxxx	RSKH-120-xxxxx	RSCH-015-20025	RSTH-03x-20021	RSRY-708-00125	3
0.3902 - 0.4102	9.91 - 10.42	3	RSKH-230-xxxxx	RSKH-130-xxxxx	RSCH-015-30025	RSTH-03x-30021	RSRY-708-00125	3
0.4051 - 0.4252	10.29 - 10.80	1	RSKH-210-xxxxx	RSKH-110-xxxxx	RSCH-015-10026	RSTH-03x-10024	RSRY-708-00125	3
0.4051 - 0.4252	10.29 - 10.80	2	RSKH-220-xxxxx	RSKH-120-xxxxx	RSCH-015-20026	RSTH-03x-20024	RSRY-708-00125	3
0.4051 - 0.4252	10.29 - 10.80	3	RSKH-230-xxxxx	RSKH-130-xxxxx	RSCH-015-30026	RSTH-03x-30024	RSRY-708-00125	3
0.4217 - 0.4413	10.71 - 11.21	1	RSKH-210-xxxxx	RSKH-110-xxxxx	RSCH-015-10027	RSTH-03x-10025	RSRY-708-00125	3
0.4217 - 0.4413	10.71 - 11.21	2	RSKH-220-xxxxx	RSKH-120-xxxxx	RSCH-015-20027	RSTH-03x-20025	RSRY-708-00125	3
0.4217 - 0.4413	10.71 - 11.21	3	RSKH-230-xxxxx	RSKH-130-xxxxx	RSCH-015-30027	RSTH-03x-30025	RSRY-708-00125	3
0.4374 - 0.4571	11.11 - 11.61	1	RSKH-210-xxxxx	RSKH-110-xxxxx	RSCH-015-10028	RSTH-03x-10028	RSRY-708-00125	3
0.4374 - 0.4571	11.11 - 11.61	2	RSKH-220-xxxxx	RSKH-120-xxxxx	RSCH-015-20028	RSTH-03x-20028	RSRY-708-00125	3
0.4374 - 0.4571	11.11 - 11.61	3	RSKH-230-xxxxx	RSKH-130-xxxxx	RSCH-015-30028	RSTH-03x-30028	RSRY-708-00125	3
0.4512 - 0.4709	11.46 - 11.96	1	RSKH-210-xxxxx	RSKH-110-xxxxx	RSCH-015-10029	RSTH-03x-10021	RSRY-708-00156	3
0.4512 - 0.4709	11.46 - 11.96	2	RSKH-220-xxxxx	RSKH-120-xxxxx	RSCH-015-20029	RSTH-03x-20021	RSRY-708-00156	3
0.4512 - 0.4709	11.46 - 11.96	3	RSKH-230-xxxxx	RSKH-130-xxxxx	RSCH-015-30029	RSTH-03x-30021	RSRY-708-00156	3
0.4681 - 0.4878	11.89 - 12.39	1	RSKH-210-xxxxx	RSKH-110-xxxxx	RSCH-015-10030	RSTH-03x-10024	RSRY-708-00156	3
0.4681 - 0.4878	11.89 - 12.39	2	RSKH-220-xxxxx	RSKH-120-xxxxx	RSCH-015-20030	RSTH-03x-20024	RSRY-708-00156	3
0.4681 - 0.4878	11.89 - 12.39	3	RSKH-230-xxxxx	RSKH-130-xxxxx	RSCH-015-30030	RSTH-03x-30024	RSRY-708-00156	3
0.4831 - 0.5028	12.27 - 12.77	1	RSKH-210-xxxxx	RSKH-110-xxxxx	RSCH-015-10031	RSTH-03x-10025	RSRY-708-00156	3
0.4831 - 0.5028	12.27 - 12.77	2	RSKH-220-xxxxx	RSKH-120-xxxxx	RSCH-015-20031	RSTH-03x-20025	RSRY-708-00156	3
0.4831 - 0.5028	12.27 - 12.77	3	RSKH-230-xxxxx	RSKH-130-xxxxx	RSCH-015-30031	RSTH-03x-30025	RSRY-708-00156	3

\*xxxxx = Indicate to 2 metric decimal places the size to be burnished (e.g. short series roller burnisher Ø 10.25mm with MT.1 shank: RSKH-210-01025).

\*\*x = A number that will vary from 2 to 8 depending upon the exact diameter to be burnished. See page D: 6 for the correct identification of the "x" value.

**NOTE:** Each roller burnishing tool comes assembled complete with cage, cone, and rolls.

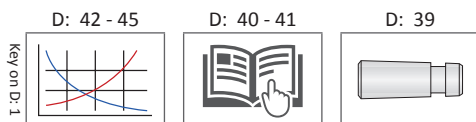

A DRILLING  
B BORING  
C REAMING  
D BURNISHING  
E THREADING  
X SPECIALS

## Roller Burnishing Tools | Through Holes

I Series | Diameter Range: 0.4976" - 0.6634" (12.64mm - 16.85mm)

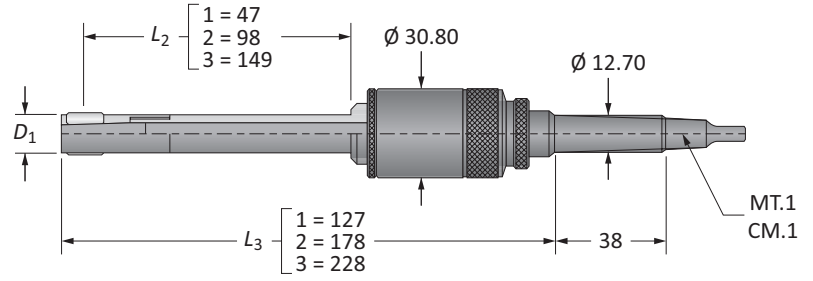

D <sub>1</sub>		L	Part No.		Spare Parts			Qty Rolls
Imperial (in)	Metric (mm)		Assembly with Morse Taper Shank	Assembly with Straight Shank	Cage	Cone	Rolls	
0.4976 - 0.5315	12.64 - 13.50	1	RDKI-210-01264	RDKI-110-01264	RDCI-400-00500	RDTI-031-10032	RDRY-704-00156	5
0.4976 - 0.5315	12.64 - 13.50	2	RDKI-220-01264	RDKI-120-01264	RDCI-400-00500	RDTI-031-20032	RDRY-704-00156	5
0.4976 - 0.5315	12.64 - 13.50	3	RDKI-230-01264	RDKI-130-01264	RDCI-400-00500	RDTI-031-30032	RDRY-704-00156	5
0.5295 - 0.5689	13.45 - 14.45	1	RDKI-210-01345	RDKI-110-01345	RDCI-400-00531	RDTI-031-10034	RDRY-704-00156	5
0.5295 - 0.5689	13.45 - 14.45	2	RDKI-220-01345	RDKI-120-01345	RDCI-400-00531	RDTI-031-20034	RDRY-704-00156	5
0.5295 - 0.5689	13.45 - 14.45	3	RDKI-230-01345	RDKI-130-01345	RDCI-400-00531	RDTI-031-30034	RDRY-704-00156	5
0.5610 - 0.6004	14.25 - 15.25	1	RDKI-210-01425	RDKI-110-01425	RDCI-400-00562	RDTI-031-10034	RDRY-704-00172	5
0.5610 - 0.6004	14.25 - 15.25	2	RDKI-220-01425	RDKI-120-01425	RDCI-400-00562	RDTI-031-20034	RDRY-704-00172	5
0.5610 - 0.6004	14.25 - 15.25	3	RDKI-230-01425	RDKI-130-01425	RDCI-400-00562	RDTI-031-30034	RDRY-704-00172	5
0.5925 - 0.6319	15.05 - 16.05	1	RDKI-210-01505	RDKI-110-01505	RDCI-400-00593	RDTI-031-10038	RDRY-704-00172	5
0.5925 - 0.6319	15.05 - 16.05	2	RDKI-220-01505	RDKI-120-01505	RDCI-400-00593	RDTI-031-20038	RDRY-704-00172	5
0.5925 - 0.6319	15.05 - 16.05	3	RDKI-230-01505	RDKI-130-01505	RDCI-400-00593	RDTI-031-30038	RDRY-704-00172	5
0.6240 - 0.6634	15.85 - 16.85	1	RDKI-210-01585	RDKI-110-01585	RDCI-400-00625	RDTI-031-10038	RDRY-701-00187	5
0.6240 - 0.6634	15.85 - 16.85	2	RDKI-220-01585	RDKI-120-01585	RDCI-400-00625	RDTI-031-20038	RDRY-701-00187	5
0.6240 - 0.6634	15.85 - 16.85	3	RDKI-230-01585	RDKI-130-01585	RDCI-400-00625	RDTI-031-30038	RDRY-701-00187	5

**NOTE:** Each roller burnishing tool comes assembled complete with cage, cone, and rolls.

Key on D: 1

D: 42 - 45

D: 40 - 41

D: 38



## Roller Burnishing Tools | Blind Holes

I Series | Diameter Range: 0.4976" - 0.6634" (12.64mm - 16.85mm)

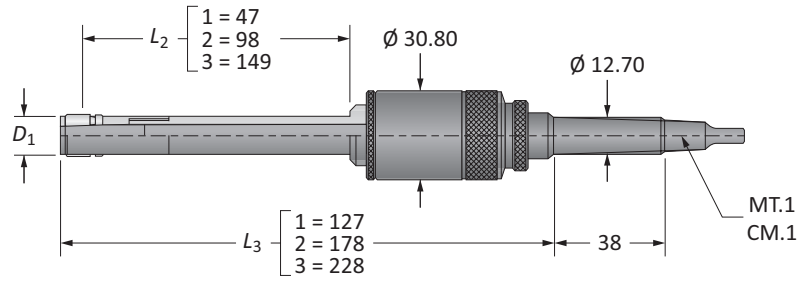

D <sub>1</sub>		L	Part No.*		Spare Parts			Qty Rolls
Imperial (in)	Metric (mm)		Assembly with Morse Taper Shank	Assembly with Straight Shank	Cage	Cone**	Rolls	
0.4976 - 0.5315	12.64 - 13.50	1	RSKI-210-xxxxx	RSKI-110-xxxxx	RSCI-400-00500	RSTI-03X-10032	RSRY-708-00156	5
0.4976 - 0.5315	12.64 - 13.50	2	RSKI-220-xxxxx	RSKI-120-xxxxx	RSCI-400-00500	RSTI-03X-20032	RSRY-708-00156	5
0.4976 - 0.5315	12.64 - 13.50	3	RSKI-230-xxxxx	RSKI-130-xxxxx	RSCI-400-00500	RSTI-03X-30032	RSRY-708-00156	5
0.5295 - 0.5689	13.45 - 14.45	1	RSKI-210-xxxxx	RSKI-110-xxxxx	RSCI-400-00531	RSTI-03X-10034	RSRY-708-00156	5
0.5295 - 0.5689	13.45 - 14.45	2	RSKI-220-xxxxx	RSKI-120-xxxxx	RSCI-400-00531	RSTI-03X-20034	RSRY-708-00156	5
0.5295 - 0.5689	13.45 - 14.45	3	RSKI-230-xxxxx	RSKI-130-xxxxx	RSCI-400-00531	RSTI-03X-30034	RSRY-708-00156	5
0.5610 - 0.6004	14.25 - 15.25	1	RSKI-210-xxxxx	RSKI-110-xxxxx	RSCI-400-00562	RSTI-03X-10034	RSRY-708-00172	5
0.5610 - 0.6004	14.25 - 15.25	2	RSKI-220-xxxxx	RSKI-120-xxxxx	RSCI-400-00562	RSTI-03X-20034	RSRY-708-00172	5
0.5610 - 0.6004	14.25 - 15.25	3	RSKI-230-xxxxx	RSKI-130-xxxxx	RSCI-400-00562	RSTI-03X-30034	RSRY-708-00172	5
0.5925 - 0.6319	15.05 - 16.05	1	RSKI-210-xxxxx	RSKI-110-xxxxx	RSCI-400-00593	RSTI-03X-10038	RSRY-708-00172	5
0.5925 - 0.6319	15.05 - 16.05	2	RSKI-220-xxxxx	RSKI-120-xxxxx	RSCI-400-00593	RSTI-03X-20038	RSRY-708-00172	5
0.5925 - 0.6319	15.05 - 16.05	3	RSKI-230-xxxxx	RSKI-130-xxxxx	RSCI-400-00593	RSTI-03X-30038	RSRY-708-00172	5
0.6240 - 0.6634	15.85 - 16.85	1	RSKI-210-xxxxx	RSKI-110-xxxxx	RSCI-400-00625	RSTI-03X-10038	RSRY-708-00187	5
0.6240 - 0.6634	15.85 - 16.85	2	RSKI-220-xxxxx	RSKI-120-xxxxx	RSCI-400-00625	RSTI-03X-20038	RSRY-708-00187	5
0.6240 - 0.6634	15.85 - 16.85	3	RSKI-230-xxxxx	RSKI-130-xxxxx	RSCI-400-00625	RSTI-03X-30038	RSRY-708-00187	5

\*xxxxx = Indicate to 2 metric decimal places the size to be burnished (e.g. long series roller burnisher Ø 14.00mm with MT.1 shank: RSKI-230-01400).

\*\*x = A number that will vary from 2 to 8 depending upon the exact diameter to be burnished. See page D: 6 for the correct identification of the "x" value.

**NOTE:** Each roller burnishing tool comes assembled complete with cage, cone, and rolls.

D: 42 - 45

D: 40 - 41

D: 39

Key on D: 1

## Roller Burnishing Tools | Through Holes

K Series | Diameter Range: 0.6535" - 0.9740" (16.60mm - 24.74mm)

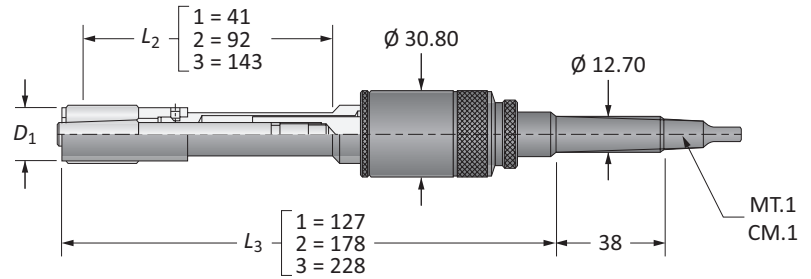

D <sub>1</sub>		L	Part No.		Spare Parts			Qty Rolls
Imperial (in)	Metric (mm)		Assembly with Morse Taper Shank	Assembly with Straight Shank	Cage	Cone	Rolls	
0.6535 - 0.6933	16.60 - 17.61	1	RDKK-210-01660	RDKK-110-01660	RDCK-011-00042	RDTK-031-00042	RDRY-701-00187	5
0.6535 - 0.6933	16.60 - 17.61	2	RDKK-220-01660	RDKK-120-01660	RDCK-011-00042	RDTK-031-00042	RDRY-701-00187	5
0.6535 - 0.6933	16.60 - 17.61	3	RDKK-230-01660	RDKK-130-01660	RDCK-011-00042	RDTK-031-00042	RDRY-701-00187	5
0.6850 - 0.7240	17.40 - 18.39	1	RDKK-210-01740	RDKK-110-01740	RDCK-011-00044	RDTK-031-00044	RDRY-701-00187	5
0.6850 - 0.7240	17.40 - 18.39	2	RDKK-220-01740	RDKK-120-01740	RDCK-011-00044	RDTK-031-00044	RDRY-701-00187	5
0.6850 - 0.7240	17.40 - 18.39	3	RDKK-230-01740	RDKK-130-01740	RDCK-011-00044	RDTK-031-00044	RDRY-701-00187	5
0.7161 - 0.7551	18.19 - 19.18	1	RDKK-210-01819	RDKK-110-01819	RDCK-011-00046	RDTK-031-00042	RDRY-701-00218	5
0.7161 - 0.7551	18.19 - 19.18	2	RDKK-220-01819	RDKK-120-01819	RDCK-011-00046	RDTK-031-00042	RDRY-701-00218	5
0.7161 - 0.7551	18.19 - 19.18	3	RDKK-230-01819	RDKK-130-01819	RDCK-011-00046	RDTK-031-00042	RDRY-701-00218	5
0.7465 - 0.7870	18.96 - 19.99	1	RDKK-210-01896	RDKK-110-01896	RDCK-011-00048	RDTK-031-00044	RDRY-701-00218	5
0.7465 - 0.7870	18.96 - 19.99	2	RDKK-220-01896	RDKK-120-01896	RDCK-011-00048	RDTK-031-00044	RDRY-701-00218	5
0.7465 - 0.7870	18.96 - 19.99	3	RDKK-230-01896	RDKK-130-01896	RDCK-011-00048	RDTK-031-00044	RDRY-701-00218	5
0.7772 - 0.8177	19.74 - 20.77	1	RDKK-210-01974	RDKK-110-01974	RDCK-011-00050	RDTK-031-00050	RDRY-701-00218	5
0.7772 - 0.8177	19.74 - 20.77	2	RDKK-220-01974	RDKK-120-01974	RDCK-011-00050	RDTK-031-00050	RDRY-701-00218	5
0.7772 - 0.8177	19.74 - 20.77	3	RDKK-230-01974	RDKK-130-01974	RDCK-011-00050	RDTK-031-00050	RDRY-701-00218	5
0.8079 - 0.8492	20.52 - 21.57	1	RDKK-210-02052	RDKK-110-02052	RDCK-011-00052	RDTK-031-00052	RDRY-701-00218	5
0.8079 - 0.8492	20.52 - 21.57	2	RDKK-220-02052	RDKK-120-02052	RDCK-011-00052	RDTK-031-00052	RDRY-701-00218	5
0.8079 - 0.8492	20.52 - 21.57	3	RDKK-230-02052	RDKK-130-02052	RDCK-011-00052	RDTK-031-00052	RDRY-701-00218	5
0.8390 - 0.8799	21.31 - 22.35	1	RDKK-210-02131	RDKK-110-02131	RDCK-011-00054	RDTK-031-00054	RDRY-701-00218	5
0.8390 - 0.8799	21.31 - 22.35	2	RDKK-220-02131	RDKK-120-02131	RDCK-011-00054	RDTK-031-00054	RDRY-701-00218	5
0.8390 - 0.8799	21.31 - 22.35	3	RDKK-230-02131	RDKK-130-02131	RDCK-011-00054	RDTK-031-00054	RDRY-701-00218	5
0.8713 - 0.9118	22.13 - 23.16	1	RDKK-210-02213	RDKK-110-02213	RDCK-011-00056	RDTK-031-00050	RDRY-701-00265	5
0.8713 - 0.9118	22.13 - 23.16	2	RDKK-220-02213	RDKK-120-02213	RDCK-011-00056	RDTK-031-00050	RDRY-701-00265	5
0.8713 - 0.9118	22.13 - 23.16	3	RDKK-230-02213	RDKK-130-02213	RDCK-011-00056	RDTK-031-00050	RDRY-701-00265	5
0.9020 - 0.9433	22.91 - 23.96	1	RDKK-210-02291	RDKK-110-02291	RDCK-011-00058	RDTK-031-00052	RDRY-701-00265	5
0.9020 - 0.9433	22.91 - 23.96	2	RDKK-220-02291	RDKK-120-02291	RDCK-011-00058	RDTK-031-00052	RDRY-701-00265	5
0.9020 - 0.9433	22.91 - 23.96	3	RDKK-230-02291	RDKK-130-02291	RDCK-011-00058	RDTK-031-00052	RDRY-701-00265	5
0.9331 - 0.9740	23.70 - 24.74	1	RDKK-210-02370	RDKK-110-02370	RDCK-011-00060	RDTK-031-00054	RDRY-701-00265	5
0.9331 - 0.9740	23.70 - 24.74	2	RDKK-220-02370	RDKK-120-02370	RDCK-011-00060	RDTK-031-00054	RDRY-701-00265	5
0.9331 - 0.9740	23.70 - 24.74	3	RDKK-230-02370	RDKK-130-02370	RDCK-011-00060	RDTK-031-00054	RDRY-701-00265	5

**NOTE:** Each roller burnishing tool comes assembled complete with cage, cone, and rolls.

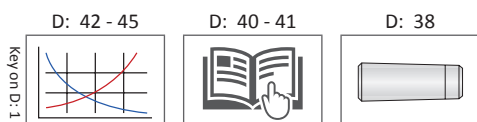



## Roller Burnishing Tools | Blind Holes

K Series | Diameter Range: 0.6535" - 0.9740" (16.60mm - 24.74mm)

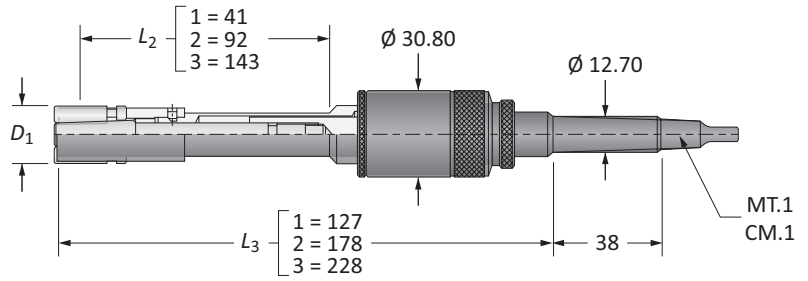

D <sub>1</sub>		L	Part No.*		Spare Parts			Qty Rolls
Imperial (in)	Metric (mm)		Assembly with Morse Taper Shank	Assembly with Straight Shank	Cage	Cone**	Rolls	
0.6535 - 0.6933	16.60 - 17.61	1	RSKK-210-xxxxx	RSKK-110-xxxxx	RSCK-015-00042	RSTK-03x-00042	RSRY-708-00187	5
0.6535 - 0.6933	16.60 - 17.61	2	RSKK-220-xxxxx	RSKK-120-xxxxx	RSCK-015-00042	RSTK-03x-00042	RSRY-708-00187	5
0.6535 - 0.6933	16.60 - 17.61	3	RSKK-230-xxxxx	RSKK-130-xxxxx	RSCK-015-00042	RSTK-03x-00042	RSRY-708-00187	5
0.6850 - 0.7240	17.40 - 18.39	1	RSKK-210-xxxxx	RSKK-110-xxxxx	RSCK-015-00044	RSTK-03x-00044	RSRY-708-00187	5
0.6850 - 0.7240	17.40 - 18.39	2	RSKK-220-xxxxx	RSKK-120-xxxxx	RSCK-015-00044	RSTK-03x-00044	RSRY-708-00187	5
0.6850 - 0.7240	17.40 - 18.39	3	RSKK-230-xxxxx	RSKK-130-xxxxx	RSCK-015-00044	RSTK-03x-00044	RSRY-708-00187	5
0.7161 - 0.7551	18.19 - 19.18	1	RSKK-210-xxxxx	RSKK-110-xxxxx	RSCK-015-00046	RSTK-03x-00042	RSRY-708-00218	5
0.7161 - 0.7551	18.19 - 19.18	2	RSKK-220-xxxxx	RSKK-120-xxxxx	RSCK-015-00046	RSTK-03x-00042	RSRY-708-00218	5
0.7161 - 0.7551	18.19 - 19.18	3	RSKK-230-xxxxx	RSKK-130-xxxxx	RSCK-015-00046	RSTK-03x-00042	RSRY-708-00218	5
0.7465 - 0.7870	18.96 - 19.99	1	RSKK-210-xxxxx	RSKK-110-xxxxx	RSCK-015-00048	RSTK-03x-00044	RSRY-708-00218	5
0.7465 - 0.7870	18.96 - 19.99	2	RSKK-220-xxxxx	RSKK-120-xxxxx	RSCK-015-00048	RSTK-03x-00044	RSRY-708-00218	5
0.7465 - 0.7870	18.96 - 19.99	3	RSKK-230-xxxxx	RSKK-130-xxxxx	RSCK-015-00048	RSTK-03x-00044	RSRY-708-00218	5
0.7772 - 0.8177	19.74 - 20.77	1	RSKK-210-xxxxx	RSKK-110-xxxxx	RSCK-015-00050	RSTK-03x-00050	RSRY-708-00218	5
0.7772 - 0.8177	19.74 - 20.77	2	RSKK-220-xxxxx	RSKK-120-xxxxx	RSCK-015-00050	RSTK-03x-00050	RSRY-708-00218	5
0.7772 - 0.8177	19.74 - 20.77	3	RSKK-230-xxxxx	RSKK-130-xxxxx	RSCK-015-00050	RSTK-03x-00050	RSRY-708-00218	5
0.8079 - 0.8492	20.52 - 21.57	1	RSKK-210-xxxxx	RSKK-110-xxxxx	RSCK-015-00052	RSTK-03x-00052	RSRY-708-00218	5
0.8079 - 0.8492	20.52 - 21.57	2	RSKK-220-xxxxx	RSKK-120-xxxxx	RSCK-015-00052	RSTK-03x-00052	RSRY-708-00218	5
0.8079 - 0.8492	20.52 - 21.57	3	RSKK-230-xxxxx	RSKK-130-xxxxx	RSCK-015-00052	RSTK-03x-00052	RSRY-708-00218	5
0.8390 - 0.8799	21.31 - 22.35	1	RSKK-210-xxxxx	RSKK-110-xxxxx	RSCK-015-00054	RSTK-03x-00054	RSRY-708-00218	5
0.8390 - 0.8799	21.31 - 22.35	2	RSKK-220-xxxxx	RSKK-120-xxxxx	RSCK-015-00054	RSTK-03x-00054	RSRY-708-00218	5
0.8390 - 0.8799	21.31 - 22.35	3	RSKK-230-xxxxx	RSKK-130-xxxxx	RSCK-015-00054	RSTK-03x-00054	RSRY-708-00218	5
0.8713 - 0.9118	22.13 - 23.16	1	RSKK-210-xxxxx	RSKK-110-xxxxx	RSCK-015-00056	RSTK-03x-00050	RSRY-708-00265	5
0.8713 - 0.9118	22.13 - 23.16	2	RSKK-220-xxxxx	RSKK-120-xxxxx	RSCK-015-00056	RSTK-03x-00050	RSRY-708-00265	5
0.8713 - 0.9118	22.13 - 23.16	3	RSKK-230-xxxxx	RSKK-130-xxxxx	RSCK-015-00056	RSTK-03x-00050	RSRY-708-00265	5
0.9020 - 0.9433	22.91 - 23.96	1	RSKK-210-xxxxx	RSKK-110-xxxxx	RSCK-015-00058	RSTK-03x-00052	RSRY-708-00265	5
0.9020 - 0.9433	22.91 - 23.96	2	RSKK-220-xxxxx	RSKK-120-xxxxx	RSCK-015-00058	RSTK-03x-00052	RSRY-708-00265	5
0.9020 - 0.9433	22.91 - 23.96	3	RSKK-230-xxxxx	RSKK-130-xxxxx	RSCK-015-00058	RSTK-03x-00052	RSRY-708-00265	5
0.9331 - 0.9740	23.70 - 24.74	1	RSKK-210-xxxxx	RSKK-110-xxxxx	RSCK-015-00060	RSTK-03x-00054	RSRY-708-00265	5
0.9331 - 0.9740	23.70 - 24.74	2	RSKK-220-xxxxx	RSKK-120-xxxxx	RSCK-015-00060	RSTK-03x-00054	RSRY-708-00265	5
0.9331 - 0.9740	23.70 - 24.74	3	RSKK-230-xxxxx	RSKK-130-xxxxx	RSCK-015-00060	RSTK-03x-00054	RSRY-708-00265	5

\*xxxxx = Indicate to 2 metric decimal places the size to be burnished (e.g. standard series roller burnisher Ø 20.00mm with MT.1 shank: RSKK-120-02000).

\*\*x = A number that will vary from 2 to 8 depending upon the exact diameter to be burnished. See page D: 6 for the correct identification of the "x" value.

**NOTE:** Each roller burnishing tool comes assembled complete with cage, cone, and rolls.

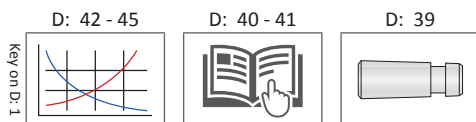

K  
A  
DRILLING  
B  
BORING  
C  
REAMING  
D  
BURNISHING  
E  
THREADING  
X  
SPECIALS

## Roller Burnishing Tools | Through Holes

L Series | Diameter Range: 0.9661" - 1.2268" (24.54mm - 31.16mm)

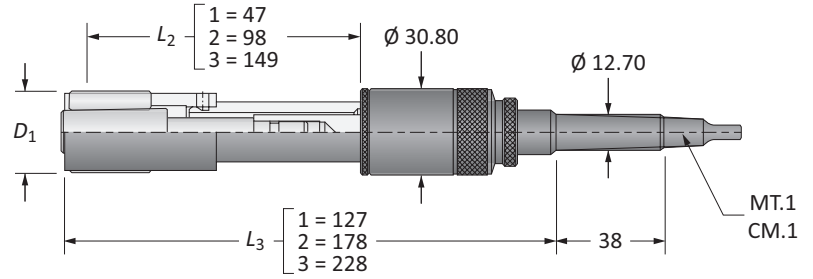

D <sub>1</sub>		L	Part No.		Spare Parts			Qty Rolls
Imperial (in)	Metric (mm)		Assembly with Morse Taper Shank	Assembly with Straight Shank	Cage	Cone	Rolls	
0.9661 - 1.0075	24.54 - 25.59	1	<b>RDKL-210-02454</b>	<b>RDKL-110-02454</b>	RDCL-011-00062	RDTL-031-00062	RDRY-701-00265	5
0.9661 - 1.0075	24.54 - 25.59	2	<b>RDKL-220-02454</b>	<b>RDKL-120-02454</b>	RDCL-011-00062	RDTL-031-00062	RDRY-701-00265	5
0.9661 - 1.0075	24.54 - 25.59	3	<b>RDKL-230-02454</b>	<b>RDKL-130-02454</b>	RDCL-011-00062	RDTL-031-00062	RDRY-701-00265	5
0.9992 - 1.0402	25.38 - 26.42	1	<b>RDKL-210-02538</b>	<b>RDKL-110-02538</b>	RDCL-011-00064	RDTL-031-00064	RDRY-701-00265	7
0.9992 - 1.0402	25.38 - 26.42	2	<b>RDKL-220-02538</b>	<b>RDKL-120-02538</b>	RDCL-011-00064	RDTL-031-00064	RDRY-701-00265	7
0.9992 - 1.0402	25.38 - 26.42	3	<b>RDKL-230-02538</b>	<b>RDKL-130-02538</b>	RDCL-011-00064	RDTL-031-00064	RDRY-701-00265	7
1.0299 - 1.0709	26.16 - 27.20	1	<b>RDKL-210-02616</b>	<b>RDKL-110-02616</b>	RDCL-011-00066	RDTL-031-00066	RDRY-701-00265	7
1.0299 - 1.0709	26.16 - 27.20	2	<b>RDKL-220-02616</b>	<b>RDKL-120-02616</b>	RDCL-011-00066	RDTL-031-00066	RDRY-701-00265	7
1.0299 - 1.0709	26.16 - 27.20	3	<b>RDKL-230-02616</b>	<b>RDKL-130-02616</b>	RDCL-011-00066	RDTL-031-00066	RDRY-701-00265	7
1.0610 - 1.1024	26.95 - 28.00	1	<b>RDKL-210-02695</b>	<b>RDKL-110-02695</b>	RDCL-011-00068	RDTL-031-00068	RDRY-701-00265	7
1.0610 - 1.1024	26.95 - 28.00	2	<b>RDKL-220-02695</b>	<b>RDKL-120-02695</b>	RDCL-011-00068	RDTL-031-00068	RDRY-701-00265	7
1.0610 - 1.1024	26.95 - 28.00	3	<b>RDKL-230-02695</b>	<b>RDKL-130-02695</b>	RDCL-011-00068	RDTL-031-00068	RDRY-701-00265	7
1.0917 - 1.1327	27.73 - 28.77	1	<b>RDKL-210-02773</b>	<b>RDKL-110-02773</b>	RDCL-011-00070	RDTL-031-00070	RDRY-701-00265	7
1.0917 - 1.1327	27.73 - 28.77	2	<b>RDKL-220-02773</b>	<b>RDKL-120-02773</b>	RDCL-011-00070	RDTL-031-00070	RDRY-701-00265	7
1.0917 - 1.1327	27.73 - 28.77	3	<b>RDKL-230-02773</b>	<b>RDKL-130-02773</b>	RDCL-011-00070	RDTL-031-00070	RDRY-701-00265	7
1.1240 - 1.1650	28.55 - 29.59	1	<b>RDKL-210-02855</b>	<b>RDKL-110-02855</b>	RDCL-011-00072	RDTL-031-00066	RDRY-701-00312	7
1.1240 - 1.1650	28.55 - 29.59	2	<b>RDKL-220-02855</b>	<b>RDKL-120-02855</b>	RDCL-011-00072	RDTL-031-00066	RDRY-701-00312	7
1.1240 - 1.1650	28.55 - 29.59	3	<b>RDKL-230-02855</b>	<b>RDKL-130-02855</b>	RDCL-011-00072	RDTL-031-00066	RDRY-701-00312	7
1.1551 - 1.1965	29.34 - 30.39	1	<b>RDKL-210-02934</b>	<b>RDKL-110-02934</b>	RDCL-011-00074	RDTL-031-00068	RDRY-701-00312	7
1.1551 - 1.1965	29.34 - 30.39	2	<b>RDKL-220-02934</b>	<b>RDKL-120-02934</b>	RDCL-011-00074	RDTL-031-00068	RDRY-701-00312	7
1.1551 - 1.1965	29.34 - 30.39	3	<b>RDKL-230-02934</b>	<b>RDKL-130-02934</b>	RDCL-011-00074	RDTL-031-00068	RDRY-701-00312	7
1.1858 - 1.2268	30.12 - 31.16	1	<b>RDKL-210-03012</b>	<b>RDKL-110-03012</b>	RDCL-011-00076	RDTL-031-00070	RDRY-701-00312	7
1.1858 - 1.2268	30.12 - 31.16	2	<b>RDKL-220-03012</b>	<b>RDKL-120-03012</b>	RDCL-011-00076	RDTL-031-00070	RDRY-701-00312	7
1.1858 - 1.2268	30.12 - 31.16	3	<b>RDKL-230-03012</b>	<b>RDKL-130-03012</b>	RDCL-011-00076	RDTL-031-00070	RDRY-701-00312	7

**NOTE:** Each roller burnishing tool comes assembled complete with cage, cone, and rolls.

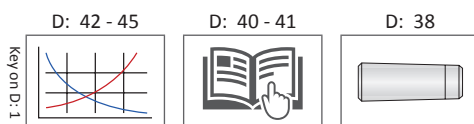





## Roller Burnishing Tools | Blind Holes

L Series | Diameter Range: 0.9661" - 1.2268" (24.54mm - 31.16mm)

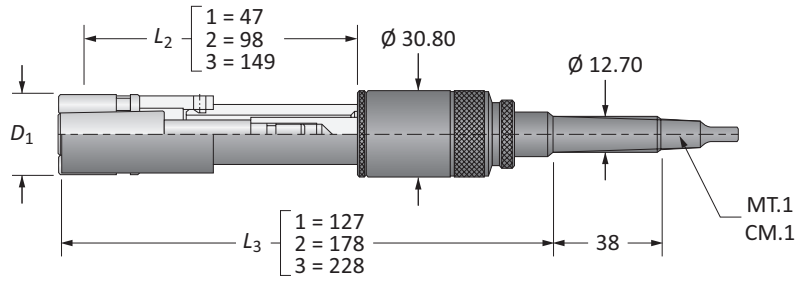

$D_1$		L	Part No.*		Spare Parts			Qty Rolls
Imperial (in)	Metric (mm)		Assembly with Morse Taper Shank	Assembly with Straight Shank	Cage	Cone**	Rolls	
0.9661 - 1.0075	24.54 - 25.59	1	RSKL-210-xxxxx	RSKL-110-xxxxx	RSCL-015-00062	RSTL-03x-00062	RSRY-708-00265	5
0.9661 - 1.0075	24.54 - 25.59	2	RSKL-220-xxxxx	RSKL-120-xxxxx	RSCL-015-00062	RSTL-03x-00062	RSRY-708-00265	5
0.9661 - 1.0075	24.54 - 25.59	3	RSKL-230-xxxxx	RSKL-130-xxxxx	RSCL-015-00062	RSTL-03x-00062	RSRY-708-00265	5
0.9992 - 1.0402	25.38 - 26.42	1	RSKL-210-xxxxx	RSKL-110-xxxxx	RSCL-015-00064	RSTL-03x-00064	RSRY-708-00265	5
0.9992 - 1.0402	25.38 - 26.42	2	RSKL-220-xxxxx	RSKL-120-xxxxx	RSCL-015-00064	RSTL-03x-00064	RSRY-708-00265	5
0.9992 - 1.0402	25.38 - 26.42	3	RSKL-230-xxxxx	RSKL-130-xxxxx	RSCL-015-00064	RSTL-03x-00064	RSRY-708-00265	5
1.0299 - 1.0709	26.16 - 27.20	1	RSKL-210-xxxxx	RSKL-110-xxxxx	RSCL-015-00066	RSTL-03x-00066	RSRY-708-00265	5
1.0299 - 1.0709	26.16 - 27.20	2	RSKL-220-xxxxx	RSKL-120-xxxxx	RSCL-015-00066	RSTL-03x-00066	RSRY-708-00265	5
1.0299 - 1.0709	26.16 - 27.20	3	RSKL-230-xxxxx	RSKL-130-xxxxx	RSCL-015-00066	RSTL-03x-00066	RSRY-708-00265	5
1.0610 - 1.1024	26.95 - 28.00	1	RSKL-210-xxxxx	RSKL-110-xxxxx	RSCL-015-00068	RSTL-03x-00068	RSRY-708-00265	5
1.0610 - 1.1024	26.95 - 28.00	2	RSKL-220-xxxxx	RSKL-120-xxxxx	RSCL-015-00068	RSTL-03x-00068	RSRY-708-00265	5
1.0610 - 1.1024	26.95 - 28.00	3	RSKL-230-xxxxx	RSKL-130-xxxxx	RSCL-015-00068	RSTL-03x-00068	RSRY-708-00265	5
1.0917 - 1.1327	27.73 - 28.77	1	RSKL-210-xxxxx	RSKL-110-xxxxx	RSCL-015-00070	RSTL-03x-00070	RSRY-708-00265	5
1.0917 - 1.1327	27.73 - 28.77	2	RSKL-220-xxxxx	RSKL-120-xxxxx	RSCL-015-00070	RSTL-03x-00070	RSRY-708-00265	5
1.0917 - 1.1327	27.73 - 28.77	3	RSKL-230-xxxxx	RSKL-130-xxxxx	RSCL-015-00070	RSTL-03x-00070	RSRY-708-00265	5
1.1240 - 1.1650	28.55 - 29.59	1	RSKL-210-xxxxx	RSKL-110-xxxxx	RSCL-015-00072	RSTL-03x-00066	RSRY-708-00312	5
1.1240 - 1.1650	28.55 - 29.59	2	RSKL-220-xxxxx	RSKL-120-xxxxx	RSCL-015-00072	RSTL-03x-00066	RSRY-708-00312	5
1.1240 - 1.1650	28.55 - 29.59	3	RSKL-230-xxxxx	RSKL-130-xxxxx	RSCL-015-00072	RSTL-03x-00066	RSRY-708-00312	5
1.1551 - 1.1965	29.34 - 30.39	1	RSKL-210-xxxxx	RSKL-110-xxxxx	RSCL-015-00074	RSTL-03x-00068	RSRY-708-00312	5
1.1551 - 1.1965	29.34 - 30.39	2	RSKL-220-xxxxx	RSKL-120-xxxxx	RSCL-015-00074	RSTL-03x-00068	RSRY-708-00312	5
1.1551 - 1.1965	29.34 - 30.39	3	RSKL-230-xxxxx	RSKL-130-xxxxx	RSCL-015-00074	RSTL-03x-00068	RSRY-708-00312	5
1.1858 - 1.2268	30.12 - 31.16	1	RSKL-210-xxxxx	RSKL-110-xxxxx	RSCL-015-00076	RSTL-03x-00070	RSRY-708-00312	5
1.1858 - 1.2268	30.12 - 31.16	2	RSKL-220-xxxxx	RSKL-120-xxxxx	RSCL-015-00076	RSTL-03x-00070	RSRY-708-00312	5
1.1858 - 1.2268	30.12 - 31.16	3	RSKL-230-xxxxx	RSKL-130-xxxxx	RSCL-015-00076	RSTL-03x-00070	RSRY-708-00312	5

\*xxxxx = Indicate to 2 metric decimal places the size to be burnished (e.g. short series roller burnisher  $\varnothing 27.50$ mm with MT.1 shank: RSKL-210-02750).

\*\*x = A number that will vary from 2 to 8 depending upon the exact diameter to be burnished. See page D: 6 for the correct identification of the "x" value.

**NOTE:** Each roller burnishing tool comes assembled complete with cage, cone, and rolls.

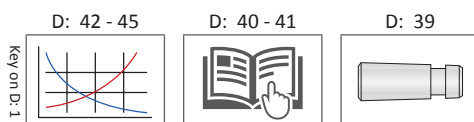

L  
A  
DRILLING  
B  
BORING  
C  
REAMING  
D  
BURNISHING  
E  
THREADING  
X  
SPECIALS

## Roller Burnishing Tools | Through Holes

F Series | Diameter Range: 0.9661" - 1.2268" (24.54mm - 31.16mm)

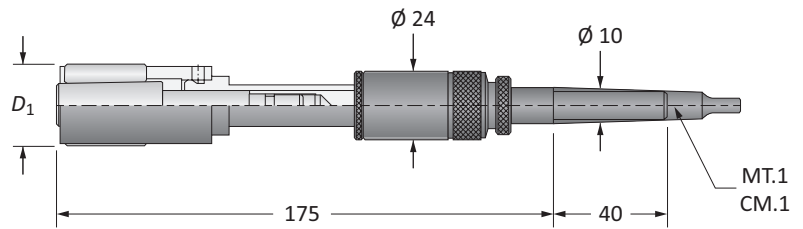

$D_1$		Part No.		Spare Parts			
Imperial (in)	Metric (mm)	Assembly with Morse Taper Shank	Assembly with Straight Shank	Cage	Cone	Rolls	Qty Rolls
0.9661 - 1.0075	24.54 - 25.59	<b>RDKF-200-02454</b>	<b>RDKF-100-02454</b>	RDCL-011-00062	RDTF-031-00062	RDRY-701-00265	5
0.9992 - 1.0402	25.38 - 26.42	<b>RDKF-200-02538</b>	<b>RDKF-100-02538</b>	RDCL-011-00064	RDTF-031-00064	RDRY-701-00265	7
1.0299 - 1.0709	26.16 - 27.20	<b>RDKF-200-02616</b>	<b>RDKF-100-02616</b>	RDCL-011-00066	RDTF-031-00066	RDRY-701-00265	7
1.0610 - 1.1024	26.95 - 28.00	<b>RDKF-200-02695</b>	<b>RDKF-100-02695</b>	RDCL-011-00068	RDTF-031-00068	RDRY-701-00265	7
1.0917 - 1.1327	27.73 - 28.77	<b>RDKF-200-02773</b>	<b>RDKF-100-02773</b>	RDCL-011-00070	RDTF-031-00070	RDRY-701-00265	7
1.1240 - 1.1650	28.55 - 29.59	<b>RDKF-200-02855</b>	<b>RDKF-100-02855</b>	RDCL-011-00072	RDTF-031-00066	RDRY-701-00312	7
1.1551 - 1.1965	29.34 - 30.39	<b>RDKF-200-02934</b>	<b>RDKF-100-02934</b>	RDCL-011-00074	RDTF-031-00068	RDRY-701-00312	7
1.1858 - 1.2268	30.12 - 31.16	<b>RDKF-200-03012</b>	<b>RDKF-100-03012</b>	RDCL-011-00076	RDTF-031-00070	RDRY-701-00312	7

**NOTE:** Each roller burnishing tool comes assembled complete with cage, cone, and rolls.

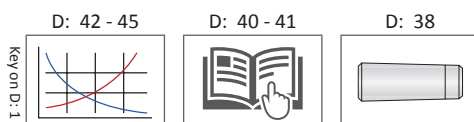



## Roller Burnishing Tools | Blind Holes

F Series | Diameter Range: 0.9661" - 1.2268" (24.54mm - 31.16mm)

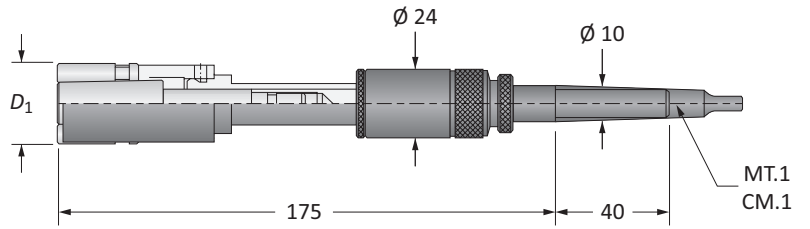

D <sub>1</sub>		Part No.*		Spare Parts			Qty Rolls
Imperial (in)	Metric (mm)	Assembly with Morse Taper Shank	Assembly with Straight Shank	Cage	Cone**	Rolls	
0.9661 - 1.0075	24.54 - 25.59	RSKF-200-xxxxx	RSKF-100-xxxxx	RSCL-015-00062	RSTF-03x-00062	RSRY-708-00265	5
0.9992 - 1.0402	25.38 - 26.42	RSKF-200-xxxxx	RSKF-100-xxxxx	RSCL-015-00064	RSTF-03x-00064	RSRY-708-00265	5
1.0299 - 1.0709	26.16 - 27.20	RSKF-200-xxxxx	RSKF-100-xxxxx	RSCL-015-00066	RSTF-03x-00066	RSRY-708-00265	5
1.0610 - 1.1024	26.95 - 28.00	RSKF-200-xxxxx	RSKF-100-xxxxx	RSCL-015-00068	RSTF-03x-00068	RSRY-708-00265	5
1.0917 - 1.1327	27.73 - 28.77	RSKF-200-xxxxx	RSKF-100-xxxxx	RSCL-015-00070	RSTF-03x-00070	RSRY-708-00265	5
1.1240 - 1.1650	28.55 - 29.59	RSKF-200-xxxxx	RSKF-100-xxxxx	RSCL-015-00072	RSTF-03x-00066	RSRY-708-00312	5
1.1551 - 1.1965	29.34 - 30.39	RSKF-200-xxxxx	RSKF-100-xxxxx	RSCL-015-00074	RSTF-03x-00068	RSRY-708-00312	5
1.1858 - 1.2268	30.12 - 31.16	RSKF-200-xxxxx	RSKF-100-xxxxx	RSCL-015-00076	RSTF-03x-00070	RSRY-708-00312	5

\*xxxxx = Indicate to 2 metric decimal places the size to be burnished (e.g. roller burnisher Ø 27.00mm with MT.1 shank: RSKF-200-02700).

\*\*x = A number that will vary from 2 to 8 depending upon the exact diameter to be burnished. See page D: 6 for the correct identification of the "x" value.

**NOTE:** Each roller burnishing tool comes assembled complete with cage, cone, and rolls.

Key on D: 1

D: 42 - 45

D: 40 - 41

D: 39

## Roller Burnishing Tools | Through Holes

M Series | Diameter Range: 1.2146" - 1.4118" (30.85mm - 35.86mm)

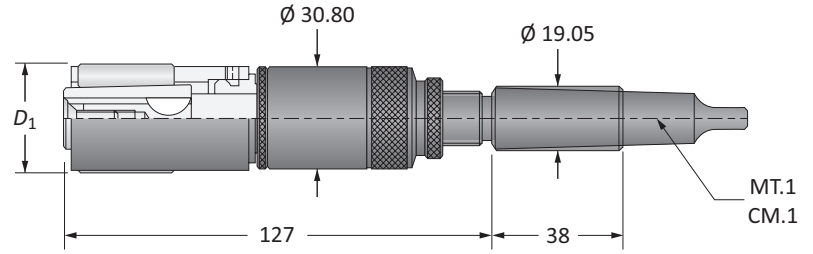

$D_1$		Part No.		Spare Parts			
Imperial (in)	Metric (mm)	Assembly with Morse Taper Shank	Assembly with Straight Shank	Cage	Cone	Rolls	Qty Rolls
1.2146 - 1.2559	30.85 - 31.90	<b>RDKM-200-03085</b>	<b>RDKM-100-03085</b>	RDCM-011-00078	RDTM-031-00078	RDRY-701-00265	7
1.2469 - 1.2878	31.67 - 32.71	<b>RDKM-200-03167</b>	<b>RDKM-100-03167</b>	RDCM-011-00080	RDTM-031-00080	RDRY-701-00265	7
1.2772 - 1.3177	32.44 - 33.47	<b>RDKM-200-03244</b>	<b>RDKM-100-03244</b>	RDCM-011-00082	RDTM-031-00082	RDRY-701-00265	7
1.3087 - 1.3500	33.24 - 34.29	<b>RDKM-200-03324</b>	<b>RDKM-100-03324</b>	RDCM-011-00084	RDTM-031-00078	RDRY-701-00312	7
1.3406 - 1.3815	34.05 - 35.09	<b>RDKM-200-03405</b>	<b>RDKM-100-03405</b>	RDCM-011-00086	RDTM-031-00080	RDRY-701-00312	7
1.3713 - 1.4118	34.83 - 35.86	<b>RDKM-200-03483</b>	<b>RDKM-100-03483</b>	RDCM-011-00088	RDTM-031-00082	RDRY-701-00312	7

**NOTE:** Each roller burnishing tool comes assembled complete with cage, cone, and rolls.

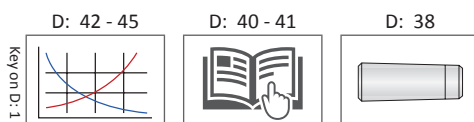



## Roller Burnishing Tools | Blind Holes

M Series | Diameter Range: 1.2146" - 1.4118" (30.85mm - 35.86mm)

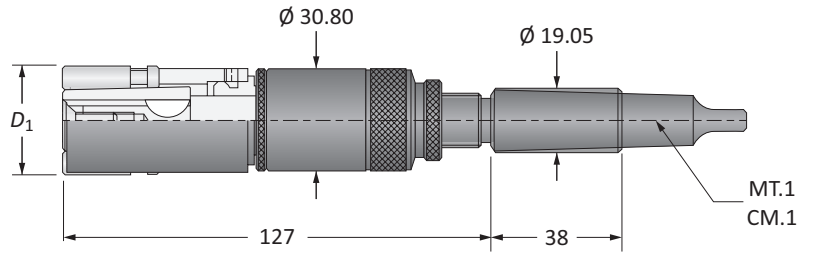

D <sub>1</sub>		Part No.*		Spare Parts			Qty Rolls
Imperial (in)	Metric (mm)	Assembly with Morse Taper Shank	Assembly with Straight Shank	Cage	Cone**	Rolls	
1.2146 - 1.2559	30.85 - 31.90	RSKM-200-xxxxx	RSKM-100-xxxxx	RSCM-015-00078	RSTM-03x-00078	RSRY-708-00265	5
1.2469 - 1.2878	31.67 - 32.71	RSKM-200-xxxxx	RSKM-100-xxxxx	RSCM-015-00080	RSTM-03x-00080	RSRY-708-00265	5
1.2772 - 1.3177	32.44 - 33.47	RSKM-200-xxxxx	RSKM-100-xxxxx	RSCM-015-00082	RSTM-03x-00082	RSRY-708-00265	5
1.3087 - 1.3500	33.24 - 34.29	RSKM-200-xxxxx	RSKM-100-xxxxx	RSCM-015-00084	RSTM-03x-00078	RSRY-708-00312	5
1.3406 - 1.3815	34.05 - 35.09	RSKM-200-xxxxx	RSKM-100-xxxxx	RSCM-015-00086	RSTM-03x-00080	RSRY-708-00312	5
1.3713 - 1.4118	34.83 - 35.86	RSKM-200-xxxxx	RSKM-100-xxxxx	RSCM-015-00088	RSTM-03x-00082	RSRY-708-00312	5

\*xxxxx = Indicate to 2 metric decimal places the size to be burnished (e.g. roller burnisher Ø 35.00mm with MT.2 shank: RSKM-200-03500).

\*\*x = A number that will vary from 2 to 8 depending upon the exact diameter to be burnished. See page D: 6 for the correct identification of the "x" value.

**NOTE:** Each roller burnishing tool comes assembled complete with cage, cone, and rolls.

D: 42 - 45

D: 40 - 41

D: 39

Key on D: 1

## Roller Burnishing Tools | Through Holes

N Series | Diameter Range: 1.4020" - 1.8492" (35.61mm - 46.97mm)

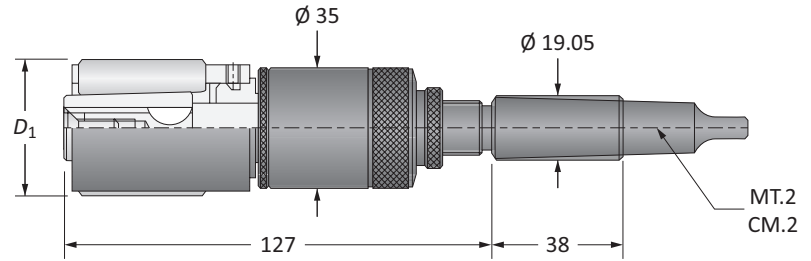

$D_1$		Part No.		Spare Parts			
Imperial (in)	Metric (mm)	Assembly with Morse Taper Shank	Assembly with Straight Shank	Cage	Cone	Rolls	Qty Rolls
1.4020 - 1.4433	35.61 - 36.66	RDKN-200-03561	RDKN-100-03561	RDCN-011-00090	RDTN-031-00090	RDRY-701-00312	7
1.4331 - 1.4740	36.40 - 37.44	RDKN-200-03640	RDKN-100-03640	RDCN-011-00092	RDTN-031-00092	RDRY-701-00312	7
1.4638 - 1.5051	37.18 - 38.23	RDKN-200-03718	RDKN-100-03718	RDCN-011-00094	RDTN-031-00094	RDRY-701-00312	7
1.4961 - 1.5370	38.00 - 39.04	RDKN-200-03800	RDKN-100-03800	RDCN-011-00096	RDTN-031-00096	RDRY-701-00312	7
1.5272 - 1.5677	38.79 - 39.82	RDKN-200-03879	RDKN-100-03879	RDCN-011-00098	RDTM-031-00080	RDRY-701-00406	7
1.5579 - 1.5992	39.57 - 40.62	RDKN-200-03957	RDKN-100-03957	RDCN-011-00100	RDTM-031-00082	RDRY-701-00406	7
1.5890 - 1.6299	40.36 - 41.40	RDKN-200-04036	RDKN-100-04036	RDCN-011-00102	RDTN-031-00090	RDRY-701-00406	7
1.6213 - 1.6618	41.18 - 42.21	RDKN-200-04118	RDKN-100-04118	RDCN-011-00104	RDTN-031-00092	RDRY-701-00406	7
1.6520 - 1.6933	41.96 - 43.01	RDKN-200-04196	RDKN-100-04196	RDCN-011-00106	RDTN-031-00094	RDRY-701-00406	7
1.6831 - 1.7240	42.75 - 43.79	RDKN-200-04275	RDKN-100-04275	RDCN-011-00108	RDTM-031-00082	RDRY-701-00468	7
1.7138 - 1.7551	43.53 - 44.58	RDKN-200-04353	RDKN-100-04353	RDCN-011-00110	RDTN-031-00090	RDRY-701-00468	7
1.7461 - 1.7870	44.35 - 45.39	RDKN-200-04435	RDKN-100-04435	RDCN-011-00112	RDTN-031-00092	RDRY-701-00468	7
1.7772 - 1.8177	45.14 - 46.17	RDKN-200-04514	RDKN-100-04514	RDCN-011-00114	RDTN-031-00094	RDRY-701-00468	7
1.8079 - 1.8492	45.92 - 46.97	RDKN-200-04592	RDKN-100-04592	RDCN-011-00116	RDTN-031-00096	RDRY-701-00468	7

**NOTE:** Each roller burnishing tool comes assembled complete with cage, cone, and rolls.

D: 42 - 45

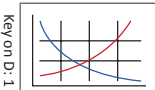

D: 40 - 41



D: 38

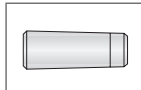



## Roller Burnishing Tools | Blind Holes

N Series | Diameter Range: 1.4020" - 1.8492" (35.61mm - 46.97mm)

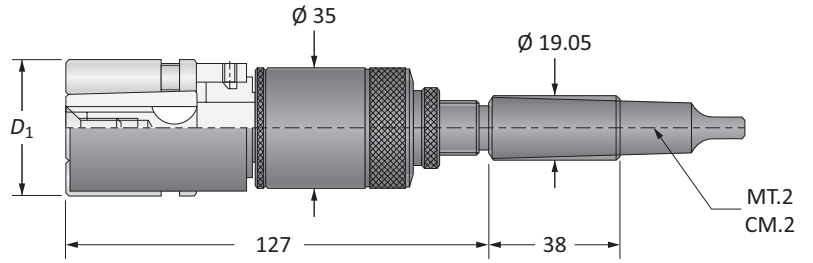

D <sub>1</sub>		Part No.*		Spare Parts			Qty Rolls
Imperial (in)	Metric (mm)	Assembly with Morse Taper Shank	Assembly with Straight Shank	Cage	Cone**	Rolls	
1.4020 - 1.4433	35.61 - 36.66	RSKN-200-xxxxx	RSKN-100-xxxxx	RSCN-015-00090	RSTN-03x-00090	RSRY-708-00312	5
1.4331 - 1.4740	36.40 - 37.44	RSKN-200-xxxxx	RSKN-100-xxxxx	RSCN-015-00092	RSTN-03x-00092	RSRY-708-00312	5
1.4638 - 1.5051	37.18 - 38.23	RSKN-200-xxxxx	RSKN-100-xxxxx	RSCN-015-00094	RSTN-03x-00094	RSRY-708-00312	5
1.4961 - 1.5370	38.00 - 39.04	RSKN-200-xxxxx	RSKN-100-xxxxx	RSCN-015-00096	RSTN-03x-00096	RSRY-708-00312	5
1.5272 - 1.5677	38.79 - 39.82	RSKN-200-xxxxx	RSKN-100-xxxxx	RSCN-015-00098	RSTM-03x-00080	RSRY-708-00406	5
1.5579 - 1.5992	39.57 - 40.62	RSKN-200-xxxxx	RSKN-100-xxxxx	RSCN-015-00100	RSTM-03x-00082	RSRY-708-00406	5
1.5890 - 1.6299	40.36 - 41.40	RSKN-200-xxxxx	RSKN-100-xxxxx	RSCN-015-00102	RSTN-03x-00090	RSRY-708-00406	5
1.6213 - 1.6618	41.18 - 42.21	RSKN-200-xxxxx	RSKN-100-xxxxx	RSCN-015-00104	RSTN-03x-00092	RSRY-708-00406	5
1.6520 - 1.6933	41.96 - 43.01	RSKN-200-xxxxx	RSKN-100-xxxxx	RSCN-015-00106	RSTN-03x-00094	RSRY-708-00406	5
1.6831 - 1.7240	42.75 - 43.79	RSKN-200-xxxxx	RSKN-100-xxxxx	RSCN-015-00108	RSTM-03x-00082	RSRY-708-00468	5
1.7138 - 1.7551	43.53 - 44.58	RSKN-200-xxxxx	RSKN-100-xxxxx	RSCN-015-00110	RSTN-03x-00090	RSRY-708-00468	5
1.7461 - 1.7870	44.35 - 45.39	RSKN-200-xxxxx	RSKN-100-xxxxx	RSCN-015-00112	RSTN-03x-00092	RSRY-708-00468	5
1.7772 - 1.8177	45.14 - 46.17	RSKN-200-xxxxx	RSKN-100-xxxxx	RSCN-015-00114	RSTN-03x-00094	RSRY-708-00468	5
1.8079 - 1.8492	45.92 - 46.97	RSKN-200-xxxxx	RSKN-100-xxxxx	RSCN-015-00116	RSTN-03x-00096	RSRY-708-00468	5

\*xxxxx = Indicate to 2 metric decimal places the size to be burnished (e.g. roller burnisher Ø 40.00mm with straight shank: RSKN-100-04000).

\*\*x = A number that will vary from 2 to 8 depending upon the exact diameter to be burnished. See page D: 6 for the correct identification of the "x" value.

**NOTE:** Each roller burnishing tool comes assembled complete with cage, cone, and rolls.

D: 42 - 45

D: 40 - 41

D: 39

Key on D: 1

## Roller Burnishing Tools | Through Holes

O Series | Diameter Range: 1.8390" - 2.2240" (46.71mm - 56.49mm)

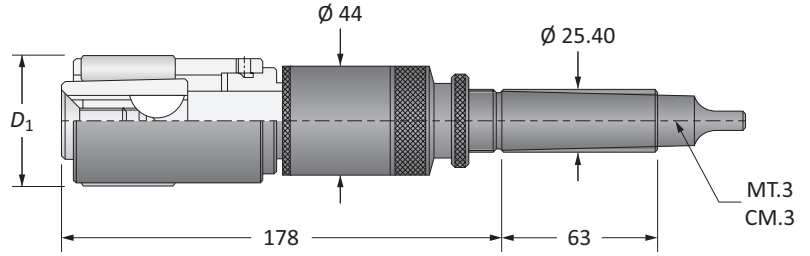

### Through Holes

D <sub>1</sub>		Part No.		Spare Parts			
Imperial (in)	Metric (mm)	Assembly with Morse Taper Shank	Assembly with Straight Shank	Cage	Cone	Rolls	Qty Rolls
1.8390 - 1.8799	46.71 - 47.75	<b>RDKO-200-04671</b>	<b>RDKO-100-04671</b>	RDCO-011-00118	RDTO-031-00118	RDRY-701-00312	9
1.8713 - 1.9118	47.53 - 48.56	<b>RDKO-200-04753</b>	<b>RDKO-100-04753</b>	RDCO-011-00120	RDTO-031-00120	RDRY-701-00312	9
1.9020 - 1.9433	48.31 - 49.36	<b>RDKO-200-04831</b>	<b>RDKO-100-04831</b>	RDCO-011-00122	RDTO-031-00122	RDRY-701-00312	9
1.9331 - 1.9740	49.10 - 50.14	<b>RDKO-200-04910</b>	<b>RDKO-100-04910</b>	RDCO-011-00124	RDTO-031-00124	RDRY-701-00312	9
1.9638 - 2.0051	49.88 - 50.93	<b>RDKO-200-04988</b>	<b>RDKO-100-04988</b>	RDCO-011-00126	RDTO-031-00126	RDRY-701-00312	9
1.9961 - 2.0370	50.70 - 51.74	<b>RDKO-200-05070</b>	<b>RDKO-100-05070</b>	RDCO-011-00128	RDTO-031-00128	RDRY-701-00312	9
2.0272 - 2.0681	51.49 - 52.53	<b>RDKO-200-05149</b>	<b>RDKO-100-05149</b>	RDCO-011-00130	RDTO-031-00118	RDRY-701-00406	9
2.0579 - 2.0992	52.27 - 53.32	<b>RDKO-200-05227</b>	<b>RDKO-100-05227</b>	RDCO-011-00132	RDTO-031-00120	RDRY-701-00406	9
2.0890 - 2.1299	53.06 - 54.10	<b>RDKO-200-05306</b>	<b>RDKO-100-05306</b>	RDCO-011-00134	RDTO-031-00122	RDRY-701-00406	9
2.1209 - 2.1618	53.87 - 54.91	<b>RDKO-200-05387</b>	<b>RDKO-100-05387</b>	RDCO-011-00136	RDTO-031-00124	RDRY-701-00406	9
2.1520 - 2.1933	54.66 - 55.71	<b>RDKO-200-05466</b>	<b>RDKO-100-05466</b>	RDCO-011-00138	RDTO-031-00126	RDRY-701-00406	9
2.1831 - 2.2240	55.45 - 56.49	<b>RDKO-200-05545</b>	<b>RDKO-100-05545</b>	RDCO-011-00140	RDTO-031-00128	RDRY-701-00406	9

**NOTE:** Each roller burnishing tool comes assembled complete with cage, cone, and rolls.

Key on D: 1

D: 42 - 45

D: 40 - 41

D: 38





## Roller Burnishing Tools | Blind Holes

O Series | Diameter Range: 1.8390" - 2.2240" (46.71mm - 56.49mm)

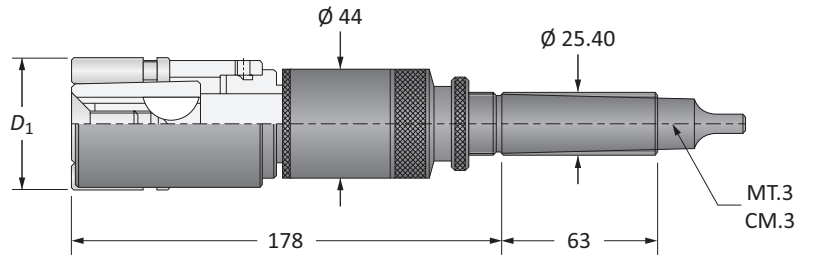

### Blind Holes

D <sub>1</sub>		Part No.*		Spare Parts			Qty Rolls
Imperial (in)	Metric (mm)	Assembly with Morse Taper Shank	Assembly with Straight Shank	Cage	Cone**	Rolls	
1.8390 - 1.8799	46.71 - 47.75	RSKO-200-xxxxx	RSKO-100-xxxxx	RSCO-015-00118	RSTO-03x-00118	RSRY-708-00312	7
1.8713 - 1.9118	47.53 - 48.56	RSKO-200-xxxxx	RSKO-100-xxxxx	RSCO-015-00120	RSTO-03x-00120	RSRY-708-00312	7
1.9020 - 1.9433	48.31 - 49.36	RSKO-200-xxxxx	RSKO-100-xxxxx	RSCO-015-00122	RSTO-03x-00122	RSRY-708-00312	7
1.9331 - 1.9740	49.10 - 50.14	RSKO-200-xxxxx	RSKO-100-xxxxx	RSCO-015-00124	RSTO-03x-00124	RSRY-708-00312	7
1.9638 - 2.0051	49.88 - 50.93	RSKO-200-xxxxx	RSKO-100-xxxxx	RSCO-015-00126	RSTO-03x-00126	RSRY-708-00312	7
1.9961 - 2.0370	50.70 - 51.74	RSKO-200-xxxxx	RSKO-100-xxxxx	RSCO-015-00128	RSTO-03x-00128	RSRY-708-00312	7
2.0272 - 2.0681	51.49 - 52.53	RSKO-200-xxxxx	RSKO-100-xxxxx	RSCO-015-00130	RSTO-03x-00118	RSRY-708-00406	7
2.0579 - 2.0992	52.27 - 53.32	RSKO-200-xxxxx	RSKO-100-xxxxx	RSCO-015-00132	RSTO-03x-00120	RSRY-708-00406	7
2.0890 - 2.1299	53.06 - 54.10	RSKO-200-xxxxx	RSKO-100-xxxxx	RSCO-015-00134	RSTO-03x-00122	RSRY-708-00406	7
2.1209 - 2.1618	53.87 - 54.91	RSKO-200-xxxxx	RSKO-100-xxxxx	RSCO-015-00136	RSTO-03x-00124	RSRY-708-00406	7
2.1520 - 2.1933	54.66 - 55.71	RSKO-200-xxxxx	RSKO-100-xxxxx	RSCO-015-00138	RSTO-03x-00126	RSRY-708-00406	7
2.1831 - 2.2240	55.45 - 56.49	RSKO-200-xxxxx	RSKO-100-xxxxx	RSCO-015-00140	RSTO-03x-00128	RSRY-708-00406	7

\*xxxxx = Indicate to 2 metric decimal places the size to be burnished (e.g. roller burnisher Ø 50.25mm with MT.3 shank: RSKO-200-05025).

\*\*x = A number that will vary from 2 to 8 depending upon the exact diameter to be burnished. See page D: 6 for the correct identification of the "x" value.

**NOTE:** Each roller burnishing tool comes assembled complete with cage, cone, and rolls.

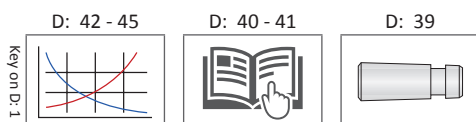

## Roller Burnishing Tools | Through Holes

P Series | Diameter Range: 2.2138" - 2.7240" (56.23mm - 69.19mm)

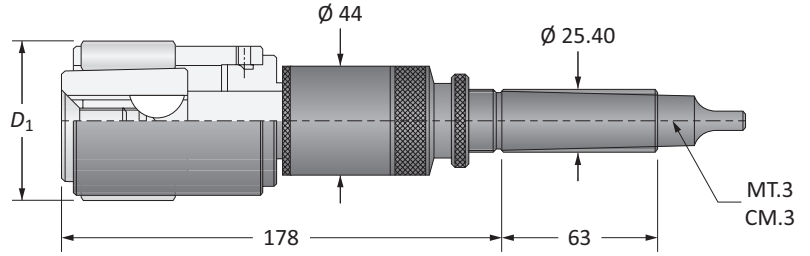

### Through Holes

D <sub>1</sub>		Part No.		Spare Parts			
Imperial (in)	Metric (mm)	Assembly with Morse Taper Shank	Assembly with Straight Shank	Cage	Cone	Rolls	Qty Rolls
2.2138 - 2.2551	56.23 - 57.28	RDKP-200-05623	RDKP-100-05623	RDCP-011-00142	RDTP-031-00142	RDRY-701-00406	9
2.2461 - 2.2870	57.05 - 58.09	RDKP-200-05705	RDKP-100-05705	RDCP-011-00144	RDTP-031-00144	RDRY-701-00406	9
2.2772 - 2.3177	57.84 - 58.87	RDKP-200-05784	RDKP-100-05784	RDCP-011-00146	RDTP-031-00146	RDRY-701-00406	9
2.3079 - 2.3492	58.62 - 59.67	RDKP-200-05862	RDKP-100-05862	RDCP-011-00148	RDTP-031-00148	RDRY-701-00406	9
2.3390 - 2.3799	59.41 - 60.45	RDKP-200-05941	RDKP-100-05941	RDCP-011-00150	RDTP-031-00142	RDRY-701-00468	9
2.3713 - 2.4118	60.23 - 61.26	RDKP-200-06023	RDKP-100-06023	RDCP-011-00152	RDTP-031-00144	RDRY-701-00468	9
2.4020 - 2.4433	61.01 - 62.06	RDKP-200-06101	RDKP-100-06101	RDCP-011-00154	RDTP-031-00146	RDRY-701-00468	9
2.4330 - 2.4740	61.80 - 62.84	RDKP-200-06180	RDKP-100-06180	RDCP-011-00156	RDTP-031-00148	RDRY-701-00468	9
2.4638 - 2.5051	62.58 - 63.63	RDKP-200-06258	RDKP-100-06258	RDCP-011-00158	RDTP-031-00158	RDRY-701-00468	9
2.4961 - 2.5370	63.40 - 64.44	RDKP-200-06340	RDKP-100-06340	RDCP-011-00160	RDTP-031-00160	RDRY-701-00468	9
2.5272 - 2.5677	64.19 - 65.22	RDKP-200-06419	RDKP-100-06419	RDCP-011-00162	RDTP-031-00162	RDRY-701-00468	9
2.5579 - 2.5992	64.97 - 66.02	RDKP-200-06497	RDKP-100-06497	RDCP-011-00164	RDTP-031-00164	RDRY-701-00468	9
2.5890 - 2.6299	65.76 - 66.80	RDKP-200-06576	RDKP-100-06576	RDCP-011-00166	RDTP-031-00158	RDRY-701-00531	9
2.6213 - 2.6618	66.58 - 67.61	RDKP-200-06658	RDKP-100-06658	RDCP-011-00168	RDTP-031-00160	RDRY-701-00531	9
2.6520 - 2.6933	67.36 - 68.41	RDKP-200-06736	RDKP-100-06736	RDCP-011-00170	RDTP-031-00162	RDRY-701-00531	9
2.6830 - 2.7240	68.15 - 69.19	RDKP-200-06815	RDKP-100-06815	RDCP-011-00172	RDTP-031-00164	RDRY-701-00531	9

**NOTE:** Each roller burnishing tool comes assembled complete with cage, cone, and rolls.

A DRILLING  
B BORING  
C REAMING  
D BURNISHING  
E THREADING  
X SPECIALS

D: 42 - 45      D: 40 - 41      D: 38



## Roller Burnishing Tools | Blind Holes

P Series | Diameter Range: 2.2138" - 2.7240" (56.23mm - 69.19mm)

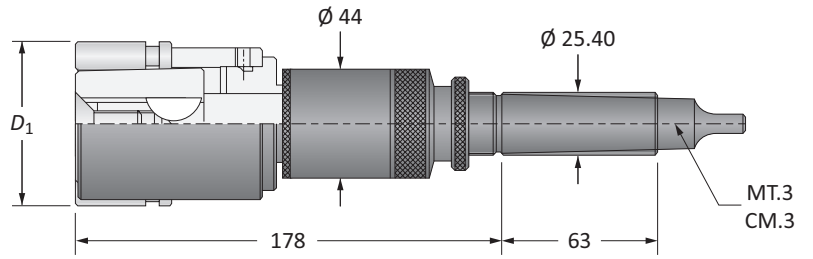

### Blind Holes

D <sub>1</sub>		Part No.*		Spare Parts			Qty Rolls
Imperial (in)	Metric (mm)	Assembly with Morse Taper Shank	Assembly with Straight Shank	Cage	Cone**	Rolls	
2.2138 - 2.2551	56.23 - 57.28	RSKP-200-xxxxx	RSKP-100-xxxxx	RSCP-015-00142	RSTP-03x-00142	RSRY-708-00406	7
2.2461 - 2.2870	57.05 - 58.09	RSKP-200-xxxxx	RSKP-100-xxxxx	RSCP-015-00144	RSTP-03x-00144	RSRY-708-00406	7
2.2772 - 2.3177	57.84 - 58.87	RSKP-200-xxxxx	RSKP-100-xxxxx	RSCP-015-00146	RSTP-03x-00146	RSRY-708-00406	7
2.3079 - 2.3492	58.62 - 59.67	RSKP-200-xxxxx	RSKP-100-xxxxx	RSCP-015-00148	RSTP-03x-00148	RSRY-708-00406	7
2.3390 - 2.3799	59.41 - 60.45	RSKP-200-xxxxx	RSKP-100-xxxxx	RSCP-015-00150	RSTP-03x-00142	RSRY-708-00468	7
2.3713 - 2.4118	60.23 - 61.26	RSKP-200-xxxxx	RSKP-100-xxxxx	RSCP-015-00152	RSTP-03x-00144	RSRY-708-00468	7
2.4020 - 2.4433	61.01 - 62.06	RSKP-200-xxxxx	RSKP-100-xxxxx	RSCP-015-00154	RSTP-03x-00146	RSRY-708-00468	7
2.4330 - 2.4740	61.80 - 62.84	RSKP-200-xxxxx	RSKP-100-xxxxx	RSCP-015-00156	RSTP-03x-00148	RSRY-708-00468	7
2.4638 - 2.5051	62.58 - 63.63	RSKP-200-xxxxx	RSKP-100-xxxxx	RSCP-015-00158	RSTP-03x-00158	RSRY-708-00468	7
2.4961 - 2.5370	63.40 - 64.44	RSKP-200-xxxxx	RSKP-100-xxxxx	RSCP-015-00160	RSTP-03x-00160	RSRY-708-00468	7
2.5272 - 2.5677	64.19 - 65.22	RSKP-200-xxxxx	RSKP-100-xxxxx	RSCP-015-00162	RSTP-03x-00162	RSRY-708-00468	7
2.5579 - 2.5992	64.97 - 66.02	RSKP-200-xxxxx	RSKP-100-xxxxx	RSCP-015-00164	RSTP-03x-00164	RSRY-708-00468	7
2.5890 - 2.6299	65.76 - 66.80	RSKP-200-xxxxx	RSKP-100-xxxxx	RSCP-015-00166	RSTP-03x-00158	RSRY-708-00531	7
2.6213 - 2.6618	66.58 - 67.61	RSKP-200-xxxxx	RSKP-100-xxxxx	RSCP-015-00168	RSTP-03x-00160	RSRY-708-00531	7
2.6520 - 2.6933	67.36 - 68.41	RSKP-200-xxxxx	RSKP-100-xxxxx	RSCP-015-00170	RSTP-03x-00162	RSRY-708-00531	7
2.6830 - 2.7240	68.15 - 69.19	RSKP-200-xxxxx	RSKP-100-xxxxx	RSCP-015-00172	RSTP-03x-00164	RSRY-708-00531	7

\*xxxxx = Indicate to 2 metric decimal places the size to be burnished (e.g. roller burnisher Ø 60.05mm with straight shank: RSKP-100-06005).

\*\*x = A number that will vary from 2 to 8 depending upon the exact diameter to be burnished. See page D: 6 for the correct identification of the "x" value.

**NOTE:** Each roller burnishing tool comes assembled complete with cage, cone, and rolls.

Key on D: 1

D: 42 - 45

D: 40 - 41

D: 39

## Roller Burnishing Tools | Through Holes

Q Series | Diameter Range: 2.7138" - 3.3492" (68.93mm - 85.07mm)

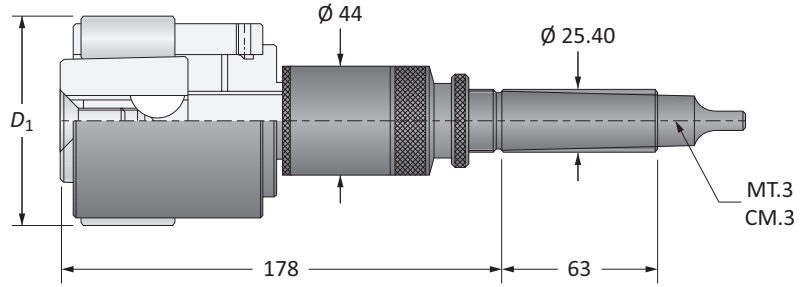

### Through Holes

D <sub>1</sub>		Part No.		Spare Parts			
Imperial (in)	Metric (mm)	Assembly with Morse Taper Shank	Assembly with Straight Shank	Cage	Cone	Rolls	Qty Rolls
2.7138 - 2.7551	68.93 - 69.98	RDKQ-200-06893	RDKQ-100-06893	RDCQ-011-00174	RDTQ-031-00174	RDRY-701-00531	9
2.7461 - 2.7870	69.75 - 70.79	RDKQ-200-06975	RDKQ-100-06975	RDCQ-011-00176	RDTQ-031-00176	RDRY-701-00531	9
2.7772 - 2.8177	70.54 - 71.57	RDKQ-200-07054	RDKQ-100-07054	RDCQ-011-00178	RDTQ-031-00178	RDRY-701-00531	9
2.8079 - 2.8504	71.32 - 72.40	RDKQ-200-07132	RDKQ-100-07132	RDCQ-011-00180	RDTQ-031-00180	RDRY-701-00531	9
2.8390 - 2.8799	72.11 - 73.15	RDKQ-200-07211	RDKQ-100-07211	RDCQ-011-00182	RDTQ-031-00182	RDRY-701-00531	9
2.8713 - 2.9118	72.93 - 73.96	RDKQ-200-07293	RDKQ-100-07293	RDCQ-011-00184	RDTQ-031-00184	RDRY-701-00531	9
2.9020 - 2.9429	73.71 - 74.75	RDKQ-200-07371	RDKQ-100-07371	RDCQ-011-00186	RDTQ-031-00174	RDRY-701-00625	9
2.9331 - 2.9740	74.50 - 75.54	RDKQ-200-07450	RDKQ-100-07450	RDCQ-011-00188	RDTQ-031-00176	RDRY-701-00625	9
2.9638 - 3.0051	75.28 - 76.33	RDKQ-200-07528	RDKQ-100-07528	RDCQ-011-00190	RDTQ-031-00178	RDRY-701-00625	9
2.9961 - 3.0370	76.10 - 77.14	RDKQ-200-07610	RDKQ-100-07610	RDCQ-011-00192	RDTQ-031-00180	RDRY-701-00625	9
3.0272 - 3.0681	76.89 - 77.93	RDKQ-200-07689	RDKQ-100-07689	RDCQ-011-00194	RDTQ-031-00182	RDRY-701-00625	9
3.0579 - 3.0992	77.67 - 78.72	RDKQ-200-07767	RDKQ-100-07767	RDCQ-011-00196	RDTQ-031-00184	RDRY-701-00625	9
3.0890 - 3.1299	78.46 - 79.50	RDKQ-200-07846	RDKQ-100-07846	RDCQ-011-00198	RDTQ-031-00198	RDRY-701-00625	9
3.1209 - 3.1618	79.27 - 80.31	RDKQ-200-07927	RDKQ-100-07927	RDCQ-011-00200	RDTQ-031-00200	RDRY-701-00625	9
3.1520 - 3.1933	80.06 - 81.11	RDKQ-200-08006	RDKQ-100-08006	RDCQ-011-00202	RDTQ-031-00202	RDRY-701-00625	9
3.1831 - 3.2240	80.85 - 81.89	RDKQ-200-08085	RDKQ-100-08085	RDCQ-011-00204	RDTQ-031-00204	RDRY-701-00625	9
3.2138 - 3.2551	81.63 - 82.68	RDKQ-200-08163	RDKQ-100-08163	RDCQ-011-00206	RDTQ-031-00198	RDRY-701-00687	9
3.2461 - 3.2870	82.45 - 83.49	RDKQ-200-08245	RDKQ-100-08245	RDCQ-011-00208	RDTQ-031-00200	RDRY-701-00687	9
3.2772 - 3.3177	83.24 - 84.27	RDKQ-200-08324	RDKQ-100-08324	RDCQ-011-00210	RDTQ-031-00202	RDRY-701-00687	9
3.3079 - 3.3492	84.02 - 85.07	RDKQ-200-08402	RDKQ-100-08402	RDCQ-011-00212	RDTQ-031-00204	RDRY-701-00687	9

**NOTE:** Each roller burnishing tool comes assembled complete with cage, cone, and rolls.

Key on D: 1

D: 42 - 45

D: 40 - 41

D: 38



## Roller Burnishing Tools | Blind Holes

Q Series | Diameter Range: 2.7138" - 3.3492" (68.93mm - 85.07mm)

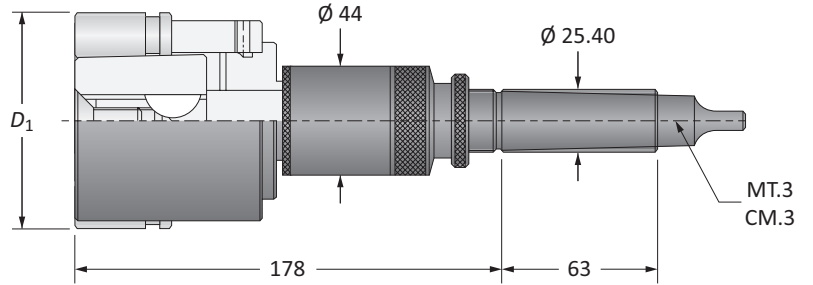

### Blind Holes

$D_1$		Part No.*		Spare Parts			Qty Rolls
Imperial (in)	Metric (mm)	Assembly with Morse Taper Shank	Assembly with Straight Shank	Cage	Cone**	Rolls	
2.7138 - 2.7551	68.93 - 69.98	RSKQ-200-xxxxx	RSKQ-100-xxxxx	RSCQ-015-00174	RSTQ-03x-00174	RSRY-708-00531	7
2.7461 - 2.7870	69.75 - 70.79	RSKQ-200-xxxxx	RSKQ-100-xxxxx	RSCQ-015-00176	RSTQ-03x-00176	RSRY-708-00531	7
2.7772 - 2.8177	70.54 - 71.57	RSKQ-200-xxxxx	RSKQ-100-xxxxx	RSCQ-015-00178	RSTQ-03x-00178	RSRY-708-00531	7
2.8079 - 2.8504	71.32 - 72.40	RSKQ-200-xxxxx	RSKQ-100-xxxxx	RSCQ-015-00180	RSTQ-03x-00180	RSRY-708-00531	7
2.8390 - 2.8799	72.11 - 73.15	RSKQ-200-xxxxx	RSKQ-100-xxxxx	RSCQ-015-00182	RSTQ-03x-00182	RSRY-708-00531	7
2.8713 - 2.9118	72.93 - 73.96	RSKQ-200-xxxxx	RSKQ-100-xxxxx	RSCQ-015-00184	RSTQ-03x-00184	RSRY-708-00531	7
2.9020 - 2.9429	73.71 - 74.75	RSKQ-200-xxxxx	RSKQ-100-xxxxx	RSCQ-015-00186	RSTQ-03x-00174	RSRY-708-00625	7
2.9331 - 2.9740	74.50 - 75.54	RSKQ-200-xxxxx	RSKQ-100-xxxxx	RSCQ-015-00188	RSTQ-03x-00176	RSRY-708-00625	7
2.9638 - 3.0051	75.28 - 76.33	RSKQ-200-xxxxx	RSKQ-100-xxxxx	RSCQ-015-00190	RSTQ-03x-00178	RSRY-708-00625	7
2.9961 - 3.0370	76.10 - 77.14	RSKQ-200-xxxxx	RSKQ-100-xxxxx	RSCQ-015-00192	RSTQ-03x-00180	RSRY-708-00625	7
3.0272 - 3.0681	76.89 - 77.93	RSKQ-200-xxxxx	RSKQ-100-xxxxx	RSCQ-015-00194	RSTQ-03x-00182	RSRY-708-00625	7
3.0579 - 3.0992	77.67 - 78.72	RSKQ-200-xxxxx	RSKQ-100-xxxxx	RSCQ-015-00196	RSTQ-03x-00184	RSRY-708-00625	7
3.0890 - 3.1299	78.46 - 79.50	RSKQ-200-xxxxx	RSKQ-100-xxxxx	RSCQ-015-00198	RSTQ-03x-00198	RSRY-708-00625	7
3.1209 - 3.1618	79.27 - 80.31	RSKQ-200-xxxxx	RSKQ-100-xxxxx	RSCQ-015-00200	RSTQ-03x-00200	RSRY-708-00625	7
3.1520 - 3.1933	80.06 - 81.11	RSKQ-200-xxxxx	RSKQ-100-xxxxx	RSCQ-015-00202	RSTQ-03x-00202	RSRY-708-00625	7
3.1831 - 3.2240	80.85 - 81.89	RSKQ-200-xxxxx	RSKQ-100-xxxxx	RSCQ-015-00204	RSTQ-03x-00204	RSRY-708-00625	7
3.2138 - 3.2551	81.63 - 82.68	RSKQ-200-xxxxx	RSKQ-100-xxxxx	RSCQ-015-00206	RSTQ-03x-00198	RSRY-708-00687	7
3.2461 - 3.2870	82.45 - 83.49	RSKQ-200-xxxxx	RSKQ-100-xxxxx	RSCQ-015-00208	RSTQ-03x-00200	RSRY-708-00687	7
3.2772 - 3.3177	83.24 - 84.27	RSKQ-200-xxxxx	RSKQ-100-xxxxx	RSCQ-015-00210	RSTQ-03x-00202	RSRY-708-00687	7
3.3079 - 3.3492	84.02 - 85.07	RSKQ-200-xxxxx	RSKQ-100-xxxxx	RSCQ-015-00212	RSTQ-03x-00204	RSRY-708-00687	7

\*xxxxx = Indicate to 2 metric decimal places the size to be burnished (e.g. roller burnisher Ø 75.00mm with MT.3 shank: RSKQ-200-07500).

\*\*x = A number that will vary from 2 to 8 depending upon the exact diameter to be burnished. See page D: 6 for the correct identification of the "x" value.

**NOTE:** Each roller burnishing tool comes assembled complete with cage, cone, and rolls.

Key on D: 1

D: 42 - 45

D: 40 - 41

D: 39

Q  
A  
DRILLING  
B  
BORING  
C  
REAMING  
D  
BURNISHING  
E  
THREADING  
X  
SPECIALS

## Roller Burnishing Tools | Through Holes

R Series | Diameter Range: 3.3390 - 4.0992" (84.81mm - 104.12mm)

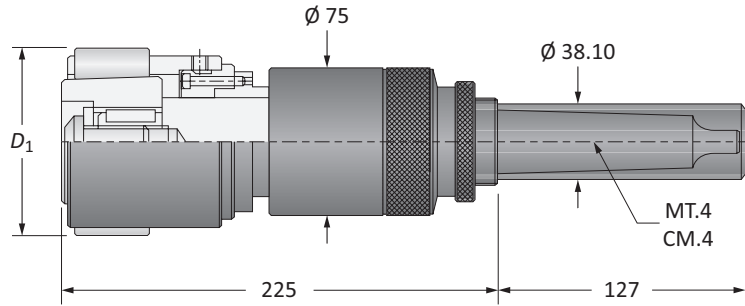

### Through Holes

$D_1$		Part No.		Spare Parts			Qty Rolls
Imperial (in)	Metric (mm)	Assembly with Morse Taper Shank	Assembly with Straight Shank	Cage	Cone	Rolls	
3.3390 - 3.3799	84.81 - 85.85	RDKR-200-08481	RDKR-100-08481	RDCR-011-00214	RDTR-073-00001	RDRY-701-00468	9
3.3713 - 3.4118	85.63 - 86.66	RDKR-200-08563	RDKR-100-08563	RDCR-011-00216	RDTR-074-00001	RDRY-701-00468	9
3.4020 - 3.4429	86.41 - 87.45	RDKR-200-08641	RDKR-100-08641	RDCR-011-00218	RDTR-071-00001	RDRY-701-00531	9
3.4331 - 3.4740	87.20 - 88.24	RDKR-200-08720	RDKR-100-08720	RDCR-011-00220	RDTR-072-00001	RDRY-701-00531	9
3.4642 - 3.5051	87.99 - 89.03	RDKR-200-08799	RDKR-100-08799	RDCR-011-00222	RDTR-073-00001	RDRY-701-00531	9
3.4957 - 3.5370	88.79 - 89.84	RDKR-200-08879	RDKR-100-08879	RDCR-011-00224	RDTR-074-00001	RDRY-701-00531	9
3.5272 - 3.5681	89.59 - 90.63	RDKR-200-08959	RDKR-100-08959	RDCR-011-00226	RDTR-075-00001	RDRY-701-00531	9
3.5579 - 3.5992	90.37 - 91.42	RDKR-200-09037	RDKR-100-09037	RDCR-011-00228	RDTR-076-00001	RDRY-701-00531	9
3.5890 - 3.6299	91.16 - 92.20	RDKR-200-09116	RDKR-100-09116	RDCR-011-00230	RDTR-071-00001	RDRY-701-00625	9
3.6209 - 3.6622	91.97 - 93.02	RDKR-200-09197	RDKR-100-09197	RDCR-011-00232	RDTR-072-00001	RDRY-701-00625	9
3.6520 - 3.6929	92.76 - 93.80	RDKR-200-09276	RDKR-100-09276	RDCR-011-00234	RDTR-073-00001	RDRY-701-00625	9
3.6831 - 3.7240	93.55 - 94.59	RDKR-200-09355	RDKR-100-09355	RDCR-011-00236	RDTR-074-00001	RDRY-701-00625	9
3.7142 - 3.7551	94.34 - 95.38	RDKR-200-09434	RDKR-100-09434	RDCR-011-00238	RDTR-075-00001	RDRY-701-00625	9
3.7461 - 3.7870	95.15 - 96.19	RDKR-200-09515	RDKR-100-09515	RDCR-011-00240	RDTR-076-00001	RDRY-701-00625	9
3.7772 - 3.8181	95.94 - 96.98	RDKR-200-09594	RDKR-100-09594	RDCR-011-00242	RDTR-077-00001	RDRY-701-00625	9
3.8079 - 3.8492	96.72 - 97.77	RDKR-200-09672	RDKR-100-09672	RDCR-011-00244	RDTR-078-00001	RDRY-701-00625	9
3.8390 - 3.8799	97.51 - 98.55	RDKR-200-09751	RDKR-100-09751	RDCR-011-00246	RDTR-075-00001	RDRY-701-00687	9
3.8709 - 3.9122	98.32 - 99.37	RDKR-200-09832	RDKR-100-09832	RDCR-011-00248	RDTR-076-00001	RDRY-701-00687	9
3.9020 - 3.9429	99.11 - 100.15	RDKR-200-09911	RDKR-100-09911	RDCR-011-00250	RDTR-077-00001	RDRY-701-00687	9
3.9331 - 3.9740	99.90 - 100.94	RDKR-200-09990	RDKR-100-09990	RDCR-011-00252	RDTR-078-00001	RDRY-701-00687	9
3.9642 - 4.0051	100.69 - 101.73	RDKR-200-10069	RDKR-100-10069	RDCR-011-00254	RDTR-079-00001	RDRY-701-00687	9
3.9961 - 4.0370	101.50 - 102.54	RDKR-200-10150	RDKR-100-10150	RDCR-011-00256	RDTR-080-00001	RDRY-701-00687	9
4.0272 - 4.0681	102.29 - 103.33	RDKR-200-10229	RDKR-100-10229	RDCR-011-00258	RDTR-081-00001	RDRY-701-00687	9
4.0579 - 4.0992	103.07 - 104.12	RDKR-200-10307	RDKR-100-10307	RDCR-011-00260	RDTR-082-00001	RDRY-701-00687	9

**NOTE:** Each roller burnishing tool comes assembled complete with cage, cone, and rolls.

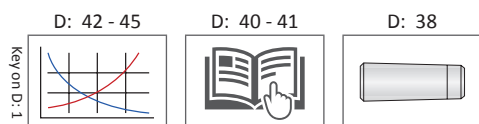



## Roller Burnishing Tools | Blind Holes

R Series | Diameter Range: 3.3390 - 4.0992" (84.81mm - 104.12mm)

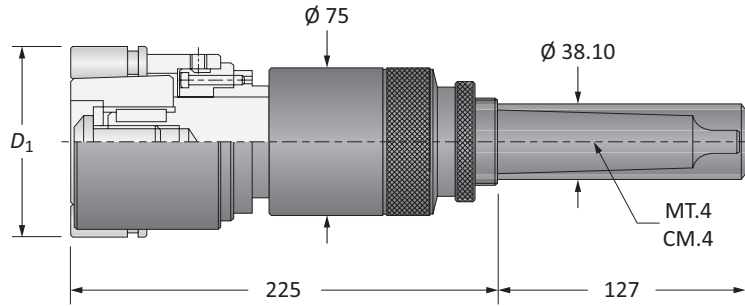

### Blind Holes

D <sub>1</sub>		Part No.*		Spare Parts			Qty Rolls
Imperial (in)	Metric (mm)	Assembly with Morse Taper Shank	Assembly with Straight Shank	Cage	Cone**	Rolls	
3.3390 - 3.3799	84.81 - 85.85	RSKR-200-xxxxx	RSKR-100-xxxxx	RSCR-015-00214	RSTR-073-0000x	RSRY-708-00468	9
3.3713 - 3.4118	85.63 - 86.66	RSKR-200-xxxxx	RSKR-100-xxxxx	RSCR-015-00216	RSTR-074-0000x	RSRY-708-00468	9
3.4020 - 3.4429	86.41 - 87.45	RSKR-200-xxxxx	RSKR-100-xxxxx	RSCR-015-00218	RSTR-071-0000x	RSRY-708-00531	9
3.4331 - 3.4740	87.20 - 88.24	RSKR-200-xxxxx	RSKR-100-xxxxx	RSCR-015-00220	RSTR-072-0000x	RSRY-708-00531	9
3.4642 - 3.5051	87.99 - 89.03	RSKR-200-xxxxx	RSKR-100-xxxxx	RSCR-015-00222	RSTR-073-0000x	RSRY-708-00531	9
3.4957 - 3.5370	88.79 - 89.84	RSKR-200-xxxxx	RSKR-100-xxxxx	RSCR-015-00224	RSTR-074-0000x	RSRY-708-00531	9
3.5272 - 3.5681	89.59 - 90.63	RSKR-200-xxxxx	RSKR-100-xxxxx	RSCR-015-00226	RSTR-075-0000x	RSRY-708-00531	9
3.5579 - 3.5992	90.37 - 91.42	RSKR-200-xxxxx	RSKR-100-xxxxx	RSCR-015-00228	RSTR-076-0000x	RSRY-708-00531	9
3.5890 - 3.6299	91.16 - 92.20	RSKR-200-xxxxx	RSKR-100-xxxxx	RSCR-015-00230	RSTR-071-0000x	RSRY-708-00625	9
3.6209 - 3.6622	91.97 - 93.02	RSKR-200-xxxxx	RSKR-100-xxxxx	RSCR-015-00232	RSTR-072-0000x	RSRY-708-00625	9
3.6520 - 3.6929	92.76 - 93.80	RSKR-200-xxxxx	RSKR-100-xxxxx	RSCR-015-00234	RSTR-073-0000x	RSRY-708-00625	9
3.6831 - 3.7240	93.55 - 94.59	RSKR-200-xxxxx	RSKR-100-xxxxx	RSCR-015-00236	RSTR-074-0000x	RSRY-708-00625	9
3.7142 - 3.7551	94.34 - 95.38	RSKR-200-xxxxx	RSKR-100-xxxxx	RSCR-015-00238	RSTR-075-0000x	RSRY-708-00625	9
3.7461 - 3.7870	95.15 - 96.19	RSKR-200-xxxxx	RSKR-100-xxxxx	RSCR-015-00240	RSTR-076-0000x	RSRY-708-00625	9
3.7772 - 3.8181	95.94 - 96.98	RSKR-200-xxxxx	RSKR-100-xxxxx	RSCR-015-00242	RSTR-077-0000x	RSRY-708-00625	9
3.8079 - 3.8492	96.72 - 97.77	RSKR-200-xxxxx	RSKR-100-xxxxx	RSCR-015-00244	RSTR-078-0000x	RSRY-708-00625	9
3.8390 - 3.8799	97.51 - 98.55	RSKR-200-xxxxx	RSKR-100-xxxxx	RSCR-015-00246	RSTR-075-0000x	RSRY-708-00687	9
3.8709 - 3.9122	98.32 - 99.37	RSKR-200-xxxxx	RSKR-100-xxxxx	RSCR-015-00248	RSTR-076-0000x	RSRY-708-00687	9
3.9020 - 3.9429	99.11 - 100.15	RSKR-200-xxxxx	RSKR-100-xxxxx	RSCR-015-00250	RSTR-077-0000x	RSRY-708-00687	9
3.9331 - 3.9740	99.90 - 100.94	RSKR-200-xxxxx	RSKR-100-xxxxx	RSCR-015-00252	RSTR-078-0000x	RSRY-708-00687	9
3.9642 - 4.0051	100.69 - 101.73	RSKR-200-xxxxx	RSKR-100-xxxxx	RSCR-015-00254	RSTR-079-0000x	RSRY-708-00687	9
3.9961 - 4.0370	101.50 - 102.54	RSKR-200-xxxxx	RSKR-100-xxxxx	RSCR-015-00256	RSTR-080-0000x	RSRY-708-00687	9
4.0272 - 1.0681	102.29 - 103.33	RSKR-200-xxxxx	RSKR-100-xxxxx	RSCR-015-00258	RSTR-081-0000x	RSRY-708-00687	9
4.0579 - 4.0992	103.07 - 104.12	RSKR-200-xxxxx	RSKR-100-xxxxx	RSCR-015-00260	RSTR-082-0000x	RSRY-708-00687	9

\*xxxxx = Indicate to 2 metric decimal places the size to be burnished (e.g. roller burnisher Ø 100.00mm with straight shank: RSKR-100-10000).

\*\*x = A number that will vary from 2 to 8 depending upon the exact diameter to be burnished. See page D: 6 for the correct identification of the "x" value.

**NOTE:** Each roller burnishing tool comes assembled complete with cage, cone, and rolls.

D: 42 - 45      D: 40 - 41      D: 39

## Roller Burnishing Tools | Through Holes

S Series | Diameter Range: 4.0890 - 5.0370" (103.86mm - 127.94mm)

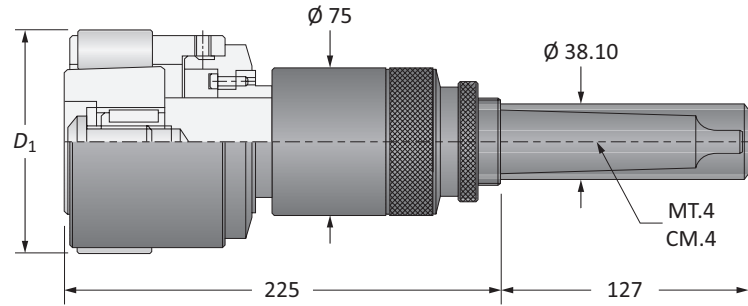

### Through Holes

$D_1$		Part No.		Spare Parts			Qty Rolls
Imperial (in)	Metric (mm)	Assembly with Morse Taper Shank	Assembly with Straight Shank	Cage	Cone	Rolls	
4.0890 - 4.1299	103.86 - 104.90	RDKS-200-10386	RDKS-100-10386	RDCS-011-00262	RDTS-083-00001	RDRY-701-00687	9
4.1209 - 4.1634	104.67 - 105.75	RDKS-200-10467	RDKS-100-10467	RDCS-011-00264	RDTS-084-00001	RDRY-701-00687	9
4.1520 - 4.1929	105.46 - 106.50	RDKS-200-10546	RDKS-100-10546	RDCS-011-00266	RDTS-085-00001	RDRY-701-00687	9
4.1831 - 4.2240	106.25 - 107.29	RDKS-200-10625	RDKS-100-10625	RDCS-011-00268	RDTS-086-00001	RDRY-701-00687	9
4.2142 - 4.2551	107.04 - 108.08	RDKS-200-10704	RDKS-100-10704	RDCS-011-00270	RDTS-087-00001	RDRY-701-00687	9
4.2461 - 4.2870	107.85 - 108.89	RDKS-200-10785	RDKS-100-10785	RDCS-011-00272	RDTS-088-00001	RDRY-701-00687	9
4.2772 - 4.3181	108.64 - 109.68	RDKS-200-10864	RDKS-100-10864	RDCS-011-00274	RDTS-089-00001	RDRY-701-00687	9
4.3079 - 4.3492	109.42 - 110.47	RDKS-200-10942	RDKS-100-10942	RDCS-011-00276	RDTS-090-00001	RDRY-701-00687	9
4.3390 - 4.3799	110.21 - 111.25	RDKS-200-11021	RDKS-100-11021	RDCS-011-00278	RDTS-083-00001	RDRY-701-00812	9
4.3709 - 4.4122	111.02 - 112.07	RDKS-200-11102	RDKS-100-11102	RDCS-011-00280	RDTS-084-00001	RDRY-701-00812	9
4.4020 - 4.4429	111.81 - 112.85	RDKS-200-11181	RDKS-100-11181	RDCS-011-00282	RDTS-085-00001	RDRY-701-00812	9
4.4331 - 4.4740	112.60 - 113.64	RDKS-200-11260	RDKS-100-11260	RDCS-011-00284	RDTS-086-00001	RDRY-701-00812	9
4.4622 - 4.5051	113.34 - 114.43	RDKS-200-11334	RDKS-100-11334	RDCS-011-00286	RDTS-087-00001	RDRY-701-00812	9
4.4961 - 4.5370	114.20 - 115.24	RDKS-200-11420	RDKS-100-11420	RDCS-011-00288	RDTS-088-00001	RDRY-701-00812	9
4.5272 - 4.5681	114.99 - 116.03	RDKS-200-11499	RDKS-100-11499	RDCS-011-00290	RDTS-089-00001	RDRY-701-00812	9
4.5579 - 4.5992	115.77 - 116.82	RDKS-200-11577	RDKS-100-11577	RDCS-011-00292	RDTS-090-00001	RDRY-701-00812	9
4.5890 - 4.6299	116.56 - 117.60	RDKS-200-11656	RDKS-100-11656	RDCS-011-00294	RDTS-091-00001	RDRY-701-00812	9
4.6209 - 4.6622	117.37 - 118.42	RDKS-200-11737	RDKS-100-11737	RDCS-011-00296	RDTS-092-00001	RDRY-701-00812	9
4.6520 - 4.6929	118.16 - 119.20	RDKS-200-11816	RDKS-100-11816	RDCS-011-00298	RDTS-093-00001	RDRY-701-00812	9
4.6831 - 4.7240	118.95 - 119.99	RDKS-200-11895	RDKS-100-11895	RDCS-011-00300	RDTS-094-00001	RDRY-701-00812	9
4.7142 - 4.7551	119.74 - 120.78	RDKS-200-11974	RDKS-100-11974	RDCS-011-00302	RDTS-095-00001	RDRY-701-00812	9
4.7461 - 4.7870	120.55 - 121.59	RDKS-200-12055	RDKS-100-12055	RDCS-011-00304	RDTS-096-00001	RDRY-701-00812	9
4.7772 - 4.8181	121.34 - 122.38	RDKS-200-12134	RDKS-100-12134	RDCS-011-00306	RDTS-097-00001	RDRY-701-00812	9
4.8079 - 4.8492	122.12 - 123.17	RDKS-200-12212	RDKS-100-12212	RDCS-011-00308	RDTS-098-00001	RDRY-701-00812	9
4.8390 - 4.8799	122.91 - 123.95	RDKS-200-12291	RDKS-100-12291	RDCS-011-00310	RDTS-099-00001	RDRY-701-00812	9
4.8709 - 4.9122	123.72 - 124.77	RDKS-200-12372	RDKS-100-12372	RDCS-011-00312	RDTS-100-00001	RDRY-701-00812	9
4.9020 - 4.9429	124.51 - 125.55	RDKS-200-12451	RDKS-100-12451	RDCS-011-01245	RDTS-031-01245	RDRY-701-00812	9
4.9331 - 4.9740	125.30 - 126.34	RDKS-200-12530	RDKS-100-12530	RDCS-011-01255	RDTS-031-01255	RDRY-701-00812	9
4.9642 - 5.0051	126.09 - 127.13	RDKS-200-12609	RDKS-100-12609	RDCS-011-01265	RDTS-031-01265	RDRY-701-00812	9
4.9961 - 5.0370	126.90 - 127.94	RDKS-200-12690	RDKS-100-12690	RDCS-011-01275	RDTS-031-01275	RDRY-701-00812	9

**NOTE:** Each roller burnishing tool comes assembled complete with cage, cone, and rolls.

D: 42 - 45

D: 40 - 41

D: 38

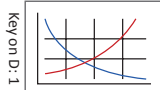





## Roller Burnishing Tools | Blind Holes

S Series | Diameter Range: 4.0890 - 5.0370" (103.86mm - 127.94mm)

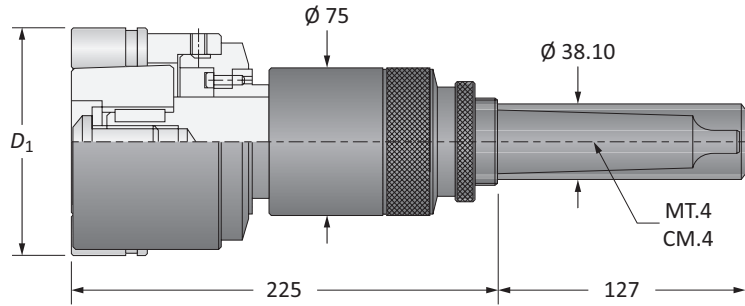

### Blind Holes

D <sub>1</sub>		Part No.*		Spare Parts			Qty Rolls
Imperial (in)	Metric (mm)	Assembly with Morse Taper Shank	Assembly with Straight Shank	Cage	Cone**	Rolls	
4.0890 - 4.1299	103.86 - 104.90	RSKS-200-xxxxx	RSKS-100-xxxxx	RSCS-015-00262	RSTS-083-0000x	RSRY-708-00687	9
4.1209 - 4.1634	104.67 - 105.75	RSKS-200-xxxxx	RSKS-100-xxxxx	RSCS-015-00264	RSTS-084-0000x	RSRY-708-00687	9
4.1520 - 4.1929	105.46 - 106.50	RSKS-200-xxxxx	RSKS-100-xxxxx	RSCS-015-00266	RSTS-085-0000x	RSRY-708-00687	9
4.1831 - 4.2240	106.25 - 107.29	RSKS-200-xxxxx	RSKS-100-xxxxx	RSCS-015-00268	RSTS-086-0000x	RSRY-708-00687	9
4.2142 - 4.2551	107.04 - 108.08	RSKS-200-xxxxx	RSKS-100-xxxxx	RSCS-015-00270	RSTS-087-0000x	RSRY-708-00687	9
4.2461 - 4.2870	107.85 - 108.89	RSKS-200-xxxxx	RSKS-100-xxxxx	RSCS-015-00272	RSTS-088-0000x	RSRY-708-00687	9
4.2772 - 4.3181	108.64 - 109.68	RSKS-200-xxxxx	RSKS-100-xxxxx	RSCS-015-00274	RSTS-089-0000x	RSRY-708-00687	9
4.3079 - 4.3492	109.42 - 110.47	RSKS-200-xxxxx	RSKS-100-xxxxx	RSCS-015-00276	RSTS-090-0000x	RSRY-708-00687	9
4.3390 - 4.3799	110.21 - 111.25	RSKS-200-xxxxx	RSKS-100-xxxxx	RSCS-015-00278	RSTS-083-0000x	RSRY-708-00812	9
4.3709 - 4.4122	111.02 - 112.07	RSKS-200-xxxxx	RSKS-100-xxxxx	RSCS-015-00280	RSTS-084-0000x	RSRY-708-00812	9
4.4020 - 4.4429	111.81 - 112.85	RSKS-200-xxxxx	RSKS-100-xxxxx	RSCS-015-00282	RSTS-085-0000x	RSRY-708-00812	9
4.4331 - 4.4740	112.60 - 113.64	RSKS-200-xxxxx	RSKS-100-xxxxx	RSCS-015-00284	RSTS-086-0000x	RSRY-708-00812	9
4.4622 - 4.5051	113.34 - 114.43	RSKS-200-xxxxx	RSKS-100-xxxxx	RSCS-015-00286	RSTS-087-0000x	RSRY-708-00812	9
4.4961 - 4.5370	114.20 - 115.24	RSKS-200-xxxxx	RSKS-100-xxxxx	RSCS-015-00288	RSTS-088-0000x	RSRY-708-00812	9
4.5272 - 4.5681	114.99 - 116.03	RSKS-200-xxxxx	RSKS-100-xxxxx	RSCS-015-00290	RSTS-089-0000x	RSRY-708-00812	9
4.5579 - 4.5992	115.77 - 116.82	RSKS-200-xxxxx	RSKS-100-xxxxx	RSCS-015-00292	RSTS-090-0000x	RSRY-708-00812	9
4.5890 - 4.6299	116.56 - 117.60	RSKS-200-xxxxx	RSKS-100-xxxxx	RSCS-015-00294	RSTS-091-0000x	RSRY-708-00812	9
4.6209 - 4.6622	117.37 - 118.42	RSKS-200-xxxxx	RSKS-100-xxxxx	RSCS-015-00296	RSTS-092-0000x	RSRY-708-00812	9
4.6520 - 4.6929	118.16 - 119.20	RSKS-200-xxxxx	RSKS-100-xxxxx	RSCS-015-00298	RSTS-093-0000x	RSRY-708-00812	9
4.6831 - 4.7240	118.95 - 119.99	RSKS-200-xxxxx	RSKS-100-xxxxx	RSCS-015-00300	RSTS-094-0000x	RSRY-708-00812	9
4.7142 - 4.7551	119.74 - 120.78	RSKS-200-xxxxx	RSKS-100-xxxxx	RSCS-015-00302	RSTS-095-0000x	RSRY-708-00812	9
4.7461 - 4.7870	120.55 - 121.59	RSKS-200-xxxxx	RSKS-100-xxxxx	RSCS-015-00304	RSTS-096-0000x	RSRY-708-00812	9
4.7772 - 4.8181	121.34 - 122.38	RSKS-200-xxxxx	RSKS-100-xxxxx	RSCS-015-00306	RSTS-097-0000x	RSRY-708-00812	9
4.8079 - 4.8492	122.12 - 123.17	RSKS-200-xxxxx	RSKS-100-xxxxx	RSCS-015-00308	RSTS-098-0000x	RSRY-708-00812	9
4.8390 - 4.8799	122.91 - 123.95	RSKS-200-xxxxx	RSKS-100-xxxxx	RSCS-015-00310	RSTS-099-0000x	RSRY-708-00812	9
4.8709 - 4.9122	123.72 - 124.77	RSKS-200-xxxxx	RSKS-100-xxxxx	RSCS-015-00312	RSTS-100-0000x	RSRY-708-00812	9
4.9020 - 4.9429	124.51 - 125.55	RSKS-200-xxxxx	RSKS-100-xxxxx	RSCS-015-01245	RSTS-03x-01245	RSRY-708-00812	9
4.9331 - 4.9740	125.30 - 126.34	RSKS-200-xxxxx	RSKS-100-xxxxx	RSCS-015-01255	RSTS-03x-01255	RSRY-708-00812	9
4.9642 - 5.0051	126.09 - 127.13	RSKS-200-xxxxx	RSKS-100-xxxxx	RSCS-015-01265	RSTS-03x-01265	RSRY-708-00812	9
4.9961 - 5.0370	126.90 - 127.94	RSKS-200-xxxxx	RSKS-100-xxxxx	RSCS-015-01275	RSTS-03x-01275	RSRY-708-00812	9

\*xxxxx = Indicate to 2 metric decimal places the size to be burnished (e.g. roller burnisher Ø 120.05mm with MT.4 shank: RSKS-200-12005).

\*\*x = A number that will vary from 2 to 8 depending upon the exact diameter to be burnished. See page D: 6 for the correct identification of the "x" value.

**NOTE:** Each roller burnishing tool comes assembled complete with cage, cone, and rolls.

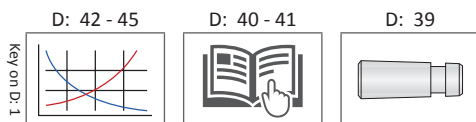

## Roller Burnishing Tools | Through Holes

T Series | Diameter Range: 5.0354 - 5.9016" (127.90mm - 149.90mm)

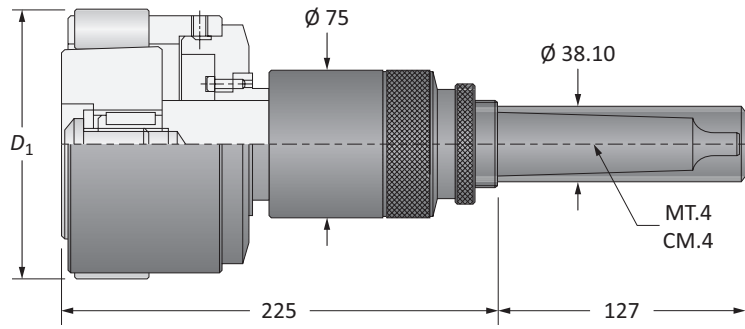

### Through Holes

D <sub>1</sub>		Part No.		Spare Parts			
Imperial (in)	Metric (mm)	Assembly with Morse Taper Shank	Assembly with Straight Shank	Cage	Cone	Rolls	Qty Rolls
5.0354 - 5.0748	127.90 - 128.90	RDKT-200-12790	RDKT-100-12790	RDCT-011-01280	RDTT-031-01280	RDRY-701-00812	11
5.0748 - 5.1142	128.90 - 129.90	RDKT-200-12890	RDKT-100-12890	RDCT-011-01290	RDTT-031-01290	RDRY-701-00812	11
5.1142 - 5.1535	129.90 - 130.90	RDKT-200-12990	RDKT-100-12990	RDCT-011-01300	RDTT-031-01300	RDRY-701-00812	11
5.1535 - 5.1929	130.90 - 131.90	RDKT-200-13090	RDKT-100-13090	RDCT-011-01310	RDTT-031-01310	RDRY-701-00812	11
5.1929 - 5.2323	131.90 - 132.90	RDKT-200-13190	RDKT-100-13190	RDCT-011-01320	RDTT-031-01320	RDRY-701-00812	11
5.2323 - 5.2717	132.90 - 133.90	RDKT-200-13290	RDKT-100-13290	RDCT-011-01330	RDTT-031-01330	RDRY-701-00812	11
5.2717 - 5.3110	133.90 - 134.90	RDKT-200-13390	RDKT-100-13390	RDCT-011-01340	RDTT-031-01340	RDRY-701-00812	11
5.3110 - 5.3504	134.90 - 135.90	RDKT-200-13490	RDKT-100-13490	RDCT-011-01350	RDTT-031-01350	RDRY-701-00812	11
5.3504 - 5.3898	135.90 - 136.90	RDKT-200-13590	RDKT-100-13590	RDCT-011-01360	RDTT-031-01360	RDRY-701-00812	11
5.3898 - 5.4291	136.90 - 137.90	RDKT-200-13690	RDKT-100-13690	RDCT-011-01370	RDTT-031-01370	RDRY-701-00812	11
5.4291 - 5.4685	137.90 - 138.90	RDKT-200-13790	RDKT-100-13790	RDCT-011-01380	RDTT-031-01380	RDRY-701-00812	11
5.4685 - 5.5079	138.90 - 139.90	RDKT-200-13890	RDKT-100-13890	RDCT-011-01390	RDTT-031-01390	RDRY-701-00812	11
5.5079 - 5.5472	139.90 - 140.90	RDKT-200-13990	RDKT-100-13990	RDCT-011-01400	RDTT-031-01400	RDRY-701-00812	11
5.5472 - 5.5866	140.90 - 141.90	RDKT-200-14090	RDKT-100-14090	RDCT-011-01410	RDTT-031-01410	RDRY-701-00812	11
5.5866 - 5.6260	141.60 - 142.90	RDKT-200-14190	RDKT-100-14190	RDCT-011-01420	RDTT-031-01420	RDRY-701-00812	11
5.6260 - 5.6654	142.90 - 143.90	RDKT-200-14290	RDKT-100-14290	RDCT-011-01430	RDTT-031-01430	RDRY-701-00812	11
5.6654 - 5.7047	143.90 - 144.90	RDKT-200-14390	RDKT-100-14390	RDCT-011-01440	RDTT-031-01440	RDRY-701-00812	11
5.7047 - 5.7441	144.90 - 145.90	RDKT-200-14490	RDKT-100-14490	RDCT-011-01450	RDTT-031-01450	RDRY-701-00812	11
5.7441 - 5.7835	145.90 - 146.90	RDKT-200-14590	RDKT-100-14590	RDCT-011-01460	RDTT-031-01460	RDRY-701-00812	11
5.7835 - 5.8228	146.90 - 147.90	RDKT-200-14690	RDKT-100-14690	RDCT-011-01470	RDTT-031-01470	RDRY-701-00812	11
5.8228 - 5.8622	147.90 - 148.90	RDKT-200-14790	RDKT-100-14790	RDCT-011-01480	RDTT-031-01480	RDRY-701-00812	11
5.8622 - 5.9016	148.90 - 149.90	RDKT-200-14890	RDKT-100-14890	RDCT-011-01490	RDTT-031-01490	RDRY-701-00812	11

**NOTE:** Each roller burnishing tool comes assembled complete with cage, cone, and rolls.

A DRILLING  
B BORING  
C REAMING  
D BURNISHING  
E THREADING  
X SPECIALS

Key on D: 1

D: 42 - 45

D: 40 - 41

D: 38



## Roller Burnishing Tools | Blind Holes

T Series | Diameter Range: 5.0354 - 5.9016" (127.90mm - 149.90mm)

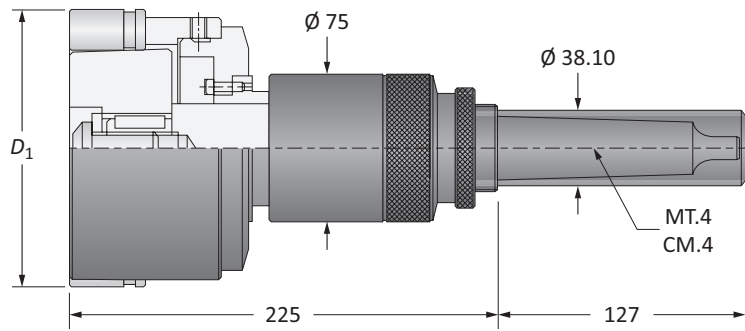

### Blind Holes

D <sub>1</sub>		Part No.*		Spare Parts			Qty Rolls
Imperial (in)	Metric (mm)	Assembly with Morse Taper Shank	Assembly with Straight Shank	Cage	Cone**	Rolls	
5.0354 - 5.0748	127.90 - 128.90	RSKT-200-xxxxx	RSKT-100-xxxxx	RSCT-015-01280	RSTT-0xx-01280	RSRY-708-00812	11
5.0748 - 5.1142	128.90 - 129.90	RSKT-200-xxxxx	RSKT-100-xxxxx	RSCT-015-01290	RSTT-0xx-01290	RSRY-708-00812	11
5.1142 - 5.1535	129.90 - 130.90	RSKT-200-xxxxx	RSKT-100-xxxxx	RSCT-015-01300	RSTT-0xx-01300	RSRY-708-00812	11
5.1535 - 5.1929	130.90 - 131.90	RSKT-200-xxxxx	RSKT-100-xxxxx	RSCT-015-01310	RSTT-0xx-01310	RSRY-708-00812	11
5.1929 - 5.2323	131.90 - 132.90	RSKT-200-xxxxx	RSKT-100-xxxxx	RSCT-015-01320	RSTT-0xx-01320	RSRY-708-00812	11
5.2323 - 5.2717	132.90 - 133.90	RSKT-200-xxxxx	RSKT-100-xxxxx	RSCT-015-01330	RSTT-0xx-01330	RSRY-708-00812	11
5.2717 - 5.3110	133.90 - 134.90	RSKT-200-xxxxx	RSKT-100-xxxxx	RSCT-015-01340	RSTT-0xx-01340	RSRY-708-00812	11
5.3110 - 5.3504	134.90 - 135.90	RSKT-200-xxxxx	RSKT-100-xxxxx	RSCT-015-01350	RSTT-0xx-01350	RSRY-708-00812	11
5.3504 - 5.3898	135.90 - 136.90	RSKT-200-xxxxx	RSKT-100-xxxxx	RSCT-015-01360	RSTT-0xx-01360	RSRY-708-00812	11
5.3898 - 5.4291	136.90 - 137.90	RSKT-200-xxxxx	RSKT-100-xxxxx	RSCT-015-01370	RSTT-0xx-01370	RSRY-708-00812	11
5.4291 - 5.4685	137.90 - 138.90	RSKT-200-xxxxx	RSKT-100-xxxxx	RSCT-015-01380	RSTT-0xx-01380	RSRY-708-00812	11
5.4685 - 5.5079	138.90 - 139.90	RSKT-200-xxxxx	RSKT-100-xxxxx	RSCT-015-01390	RSTT-0xx-01390	RSRY-708-00812	11
5.5079 - 5.5472	139.90 - 140.90	RSKT-200-xxxxx	RSKT-100-xxxxx	RSCT-015-01400	RSTT-0xx-01400	RSRY-708-00812	11
5.5472 - 5.5866	140.90 - 141.90	RSKT-200-xxxxx	RSKT-100-xxxxx	RSCT-015-01410	RSTT-0xx-01410	RSRY-708-00812	11
5.5866 - 5.6260	141.60 - 142.90	RSKT-200-xxxxx	RSKT-100-xxxxx	RSCT-015-01420	RSTT-0xx-01420	RSRY-708-00812	11
5.6260 - 5.6654	142.90 - 143.90	RSKT-200-xxxxx	RSKT-100-xxxxx	RSCT-015-01430	RSTT-0xx-01430	RSRY-708-00812	11
5.6654 - 5.7047	143.90 - 144.90	RSKT-200-xxxxx	RSKT-100-xxxxx	RSCT-015-01440	RSTT-0xx-01440	RSRY-708-00812	11
5.7047 - 5.7441	144.90 - 145.90	RSKT-200-xxxxx	RSKT-100-xxxxx	RSCT-015-01450	RSTT-0xx-01450	RSRY-708-00812	11
5.7441 - 5.7835	145.90 - 146.90	RSKT-200-xxxxx	RSKT-100-xxxxx	RSCT-015-01460	RSTT-0xx-01460	RSRY-708-00812	11
5.7835 - 5.8228	146.90 - 147.90	RSKT-200-xxxxx	RSKT-100-xxxxx	RSCT-015-01470	RSTT-0xx-01470	RSRY-708-00812	11
5.8228 - 5.8622	147.90 - 148.90	RSKT-200-xxxxx	RSKT-100-xxxxx	RSCT-015-01480	RSTT-0xx-01480	RSRY-708-00812	11
5.8622 - 5.9016	148.90 - 149.90	RSKT-200-xxxxx	RSKT-100-xxxxx	RSCT-015-01490	RSTT-0xx-01490	RSRY-708-00812	11

\*xxxxx = Indicate to 2 metric decimal places the size to be burnished (e.g. roller burnisher Ø 140.00mm with straight shank: RSKT-100-14000).

\*\*x = A number that will vary from 2 to 8 depending upon the exact diameter to be burnished. See page D: 6 for the correct identification of the "x" value.

**NOTE:** Each roller burnishing tool comes assembled complete with cage, cone, and rolls.

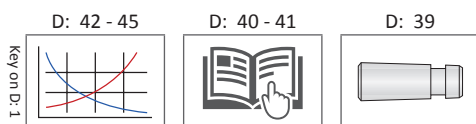

T  
A  
DRILLING  
B  
BORING  
C  
REAMING  
D  
BURNISHING  
E  
THREADING  
X  
SPECIALS

## Roller Burnishing Tools | Through Holes

U Series | Diameter Range: 5.9016" - 6.5315" (149.90mm - 165.90mm)

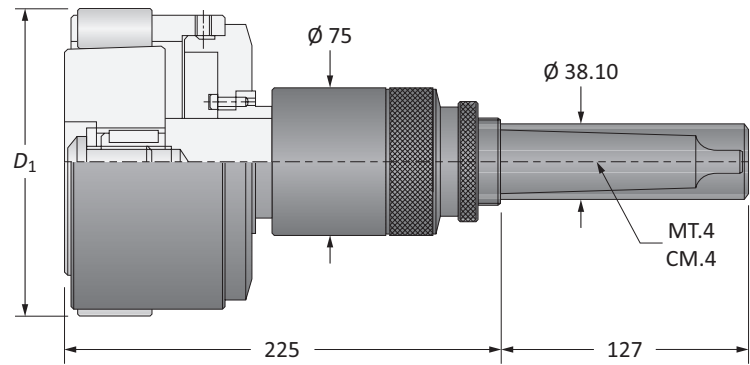

### Through Holes

$D_1$		Part No.		Spare Parts				Qty Rolls
Imperial (in)	Metric (mm)	Assembly with Morse Taper Shank	Assembly with Straight Shank	Cage	Cone	Rolls		
5.9016 - 5.9409	149.90 - 150.90	<b>RDKU-200-14990</b>	<b>RDKU-100-14990</b>	RDCU-011-01500	RDTU-031-01500	RDRY-701-00812	13	
5.9409 - 5.9803	150.90 - 151.90	<b>RDKU-200-15090</b>	<b>RDKU-100-15090</b>	RDCU-011-01510	RDTU-031-01510	RDRY-701-00812	13	
5.9803 - 6.0197	151.90 - 152.90	<b>RDKU-200-15190</b>	<b>RDKU-100-15190</b>	RDCU-011-01520	RDTU-031-01520	RDRY-701-00812	13	
6.0197 - 6.0591	152.90 - 153.90	<b>RDKU-200-15290</b>	<b>RDKU-100-15290</b>	RDCU-011-01530	RDTU-031-01530	RDRY-701-00812	13	
6.0591 - 6.0984	153.90 - 154.90	<b>RDKU-200-15390</b>	<b>RDKU-100-15390</b>	RDCU-011-01540	RDTU-031-01540	RDRY-701-00812	13	
6.0984 - 6.1378	154.90 - 155.90	<b>RDKU-200-15490</b>	<b>RDKU-100-15490</b>	RDCU-011-01550	RDTU-031-01550	RDRY-701-00812	13	
6.1378 - 6.1772	155.90 - 156.90	<b>RDKU-200-15590</b>	<b>RDKU-100-15590</b>	RDCU-011-01560	RDTU-031-01560	RDRY-701-00812	13	
6.1772 - 6.2165	156.90 - 157.90	<b>RDKU-200-15690</b>	<b>RDKU-100-15690</b>	RDCU-011-01570	RDTU-031-01570	RDRY-701-00812	13	
6.2165 - 6.2559	157.90 - 158.90	<b>RDKU-200-15790</b>	<b>RDKU-100-15790</b>	RDCU-011-01580	RDTU-031-01580	RDRY-701-00812	13	
6.2559 - 6.2953	158.90 - 159.90	<b>RDKU-200-15890</b>	<b>RDKU-100-15890</b>	RDCU-011-01590	RDTU-031-01590	RDRY-701-00812	13	
6.2953 - 6.3346	159.90 - 160.90	<b>RDKU-200-15990</b>	<b>RDKU-100-15990</b>	RDCU-011-01600	RDTU-031-01600	RDRY-701-00812	13	
6.3346 - 6.3740	160.90 - 161.90	<b>RDKU-200-16090</b>	<b>RDKU-100-16090</b>	RDCU-011-01610	RDTU-031-01610	RDRY-701-00812	13	
6.3740 - 6.4134	161.90 - 162.90	<b>RDKU-200-16190</b>	<b>RDKU-100-16190</b>	RDCU-011-01620	RDTU-031-01620	RDRY-701-00812	13	
6.4134 - 6.4528	162.90 - 163.90	<b>RDKU-200-16290</b>	<b>RDKU-100-16290</b>	RDCU-011-01630	RDTU-031-01630	RDRY-701-00812	13	
6.4528 - 6.4921	163.90 - 164.90	<b>RDKU-200-16390</b>	<b>RDKU-100-16390</b>	RDCU-011-01640	RDTU-031-01640	RDRY-701-00812	13	
6.4921 - 6.5315	164.90 - 165.90	<b>RDKU-200-16490</b>	<b>RDKU-100-16490</b>	RDCU-011-01650	RDTU-031-01650	RDRY-701-00812	13	

**NOTE:** Each roller burnishing tool comes assembled complete with cage, cone, and rolls.

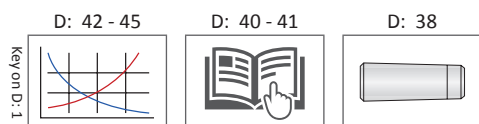



## Roller Burnishing Tools | Blind Holes

U Series | Diameter Range: 5.9016" - 6.5315" (149.90mm - 165.90mm)

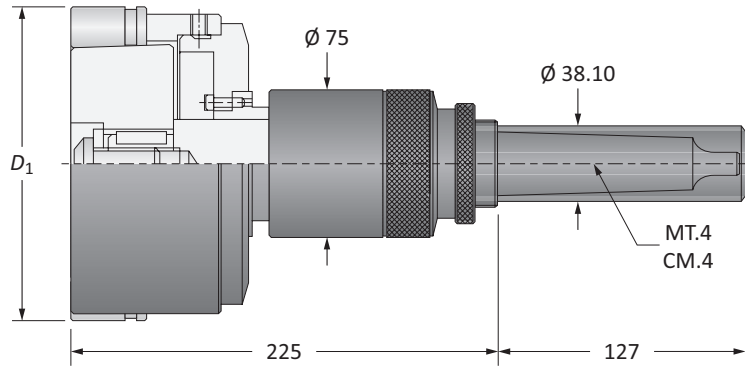

### Blind Holes

$D_1$		Part No.*		Spare Parts			Qty Rolls
Imperial (in)	Metric (mm)	Assembly with Morse Taper Shank	Assembly with Straight Shank	Cage	Cone**	Rolls	
5.9016 - 5.9409	149.90 - 150.90	RSKU-200-xxxxx	RSKU-100-xxxxx	RSCU-015-01500	RSTU-0xx-01500	RSRY-708-00812	13
5.9409 - 5.9803	150.90 - 151.90	RSKU-200-xxxxx	RSKU-100-xxxxx	RSCU-015-01510	RSTU-0xx-01510	RSRY-708-00812	13
5.9803 - 6.0197	151.90 - 152.90	RSKU-200-xxxxx	RSKU-100-xxxxx	RSCU-015-01520	RSTU-0xx-01520	RSRY-708-00812	13
6.0197 - 6.0591	152.90 - 153.90	RSKU-200-xxxxx	RSKU-100-xxxxx	RSCU-015-01530	RSTU-0xx-01530	RSRY-708-00812	13
6.0591 - 6.0984	153.90 - 154.90	RSKU-200-xxxxx	RSKU-100-xxxxx	RSCU-015-01540	RSTU-0xx-01540	RSRY-708-00812	13
6.0984 - 6.1378	154.90 - 155.90	RSKU-200-xxxxx	RSKU-100-xxxxx	RSCU-015-01550	RSTU-0xx-01550	RSRY-708-00812	13
6.1378 - 6.1772	155.90 - 156.90	RSKU-200-xxxxx	RSKU-100-xxxxx	RSCU-015-01560	RSTU-0xx-01560	RSRY-708-00812	13
6.1772 - 6.2165	156.90 - 157.90	RSKU-200-xxxxx	RSKU-100-xxxxx	RSCU-015-01570	RSTU-0xx-01570	RSRY-708-00812	13
6.2165 - 6.2559	157.90 - 158.90	RSKU-200-xxxxx	RSKU-100-xxxxx	RSCU-015-01580	RSTU-0xx-01580	RSRY-708-00812	13
6.2559 - 6.2953	158.90 - 159.90	RSKU-200-xxxxx	RSKU-100-xxxxx	RSCU-015-01590	RSTU-0xx-01590	RSRY-708-00812	13
6.2953 - 6.3346	159.90 - 160.90	RSKU-200-xxxxx	RSKU-100-xxxxx	RSCU-015-01600	RSTU-0xx-01600	RSRY-708-00812	13
6.3346 - 6.3740	160.90 - 161.90	RSKU-200-xxxxx	RSKU-100-xxxxx	RSCU-015-01610	RSTU-0xx-01610	RSRY-708-00812	13
6.3740 - 6.4134	161.90 - 162.90	RSKU-200-xxxxx	RSKU-100-xxxxx	RSCU-015-01620	RSTU-0xx-01620	RSRY-708-00812	13
6.4134 - 6.4528	162.90 - 163.90	RSKU-200-xxxxx	RSKU-100-xxxxx	RSCU-015-01630	RSTU-0xx-01630	RSRY-708-00812	13
6.4528 - 6.4921	163.90 - 164.90	RSKU-200-xxxxx	RSKU-100-xxxxx	RSCU-015-01640	RSTU-0xx-01640	RSRY-708-00812	13
6.4921 - 6.5315	164.90 - 165.90	RSKU-200-xxxxx	RSKU-100-xxxxx	RSCU-015-01650	RSTU-0xx-01650	RSRY-708-00812	13

\*xxxxx = Indicate to 2 metric decimal places the size to be burnished (e.g. roller burnisher  $\varnothing$  160.00mm with MT.4 shank: RSKU-200-16000).

\*\*x = A number that will vary from 2 to 8 depending upon the exact diameter to be burnished. See page D: 6 for the correct identification of the "x" value.

**NOTE:** Each roller burnishing tool comes assembled complete with cage, cone, and rolls.

D: 42 - 45

D: 40 - 41

D: 39

Key on D: 1

U  
A  
DRILLING  
B  
BORING  
C  
REAMING  
D  
BURNISHING  
E  
THREADING  
X  
SPECIALS

## Rolls

### Through Holes

#### Rolls 704 and 707

Part No.	Imperial (in)		Metric (mm)	
	D	L	D	L
RDRY-704-00047	0.0465	0.2500	1.18	6.35
RDRY-704-00062	0.0618	0.2500	1.57	6.35
RDRY-704-00070	0.0697	0.3126	1.77	7.94
RDRY-704-00078	0.0776	0.3752	1.97	9.53
RDRY-704-00086	0.0854	0.3752	2.17	9.53
RDRY-704-00093	0.0929	0.3752	2.36	9.53
RDRY-704-00109	0.1083	0.5000	2.75	12.70
RDRY-704-00125	0.1244	0.5000	3.16	12.70
RDRY-704-00148	0.1472	0.5000	3.74	12.70
RDRY-704-00156	0.1555	0.5000	3.95	12.70
RDRY-704-00172	0.1709	0.6252	4.34	15.88
RDRY-704-00187	0.1858	0.8772	4.72	22.28
RDRY-707-00187	0.1870	0.5000	4.75	12.70
RDRY-704-00218	0.2173	0.5000	5.52	12.70
RDRY-707-00218	0.2173	1.0000	5.52	25.40
RDRY-704-00265	0.2638	1.1252	6.70	28.58
RDRY-704-00312	0.3110	1.5000	7.90	38.10
RDRY-707-00312	0.3118	1.1252	7.92	28.58
RDRY-704-00406	0.4047	1.5000	10.28	38.10
RDRY-704-00468	0.4669	1.5000	11.86	38.10
RDRY-704-00531	0.5299	1.5000	13.46	38.10
RDRY-704-00625	0.6240	1.5000	15.85	38.10
RDRY-704-00687	0.6858	1.5000	17.42	38.10
RDRY-704-00812	0.8110	1.5000	20.60	38.10

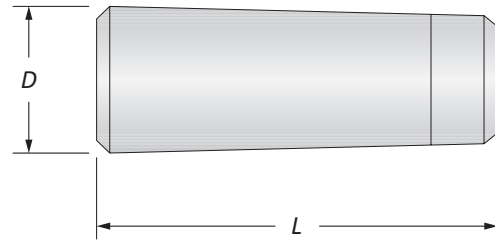

#### Rolls 701

Part No.	Imperial (in)		Metric (mm)	
	D	L	D	L
RDRY-701-00187	0.1831	0.8772	4.65	22.28
RDRY-701-00218	0.2138	1.0000	5.43	25.40
RDRY-701-00265	0.2610	1.1252	6.63	28.58
RDRY-701-00312	0.3039	1.5000	7.72	38.10
RDRY-701-00406	0.3980	1.5000	10.11	38.10
RDRY-701-00468	0.4598	1.5000	11.68	38.10
RDRY-701-00531	0.5228	1.5000	13.28	38.10
RDRY-701-00625	0.6169	1.5000	15.67	38.10
RDRY-701-00687	0.6799	1.5000	17.27	38.10
RDRY-701-00812	0.8039	1.5000	20.42	38.10

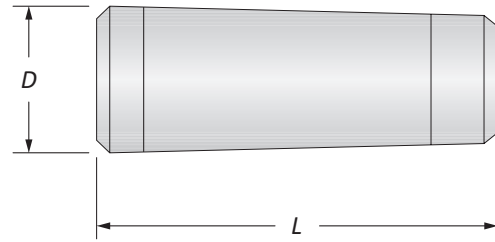

## Rolls

### Blind Holes

#### Rolls 708

Part No.	Imperial (in)		Metric (mm)	
	<i>D</i>	<i>L</i>	<i>D</i>	<i>L</i>
RSRY-708-00086	0.0854	0.3752	2.17	9.53
RSRY-708-00125	0.1244	0.5000	3.16	12.70
RSRY-708-00156	0.1555	0.5000	3.95	12.70
RSRY-708-00172	0.1709	0.6252	4.35	15.88
RSRY-708-00187	0.1858	0.8772	4.72	22.28
RSRY-708-00218	0.2173	0.5000	5.52	25.40
RSRY-708-00265	0.2638	1.1252	6.70	28.58
RSRY-708-00312	0.3110	1.5000	7.90	38.10
RSRY-708-00406	0.4047	1.5000	10.29	38.10
RSRY-708-00468	0.4669	1.5000	11.86	38.10
RSRY-708-00531	0.5299	1.5000	13.46	38.10
RSRY-708-00625	0.6240	1.5000	15.85	38.10
RSRY-708-00687	0.6858	1.5000	17.42	38.10
RSRY-708-00812	0.8110	1.5000	20.60	38.10

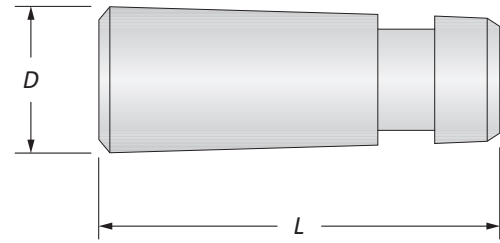

A

DRILLING

B

BORING

C

REAMING

**D**

BURNISHING

E

THREADING

X

SPECIALS

## Diameter Adjustment

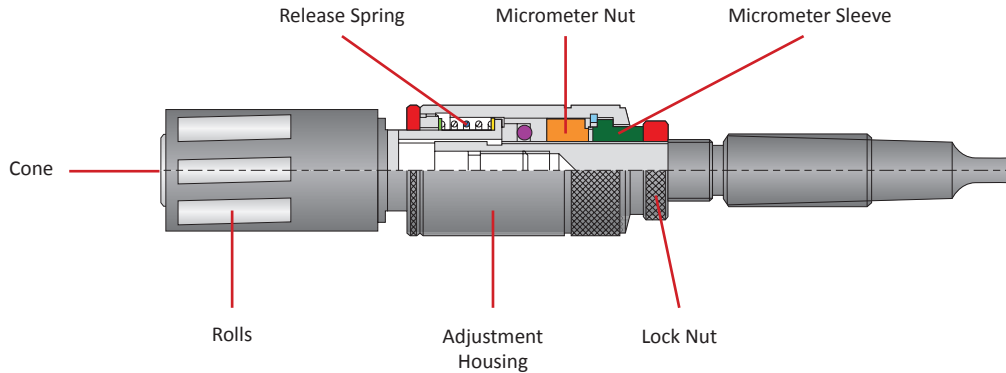

### Adjustment

The roller burnishing tool incorporates a shank, a body, and a planetary system of conical rolls that are evenly spaced by a retaining cage.

1. Unscrew the lock nut.
2. Pull the housing toward the lock nut and rotate to increase or decrease the diameter.
3. Tighten the lock nut.

**IMPORTANT:** As you increase the diameter, the cone moves forward, pushing the rolls outward. Because of this, the cone will protrude from the end of the cage, decreasing the clearance available in blind holes (see Figures 1 and 2).

Refer to chart below for clearance values.

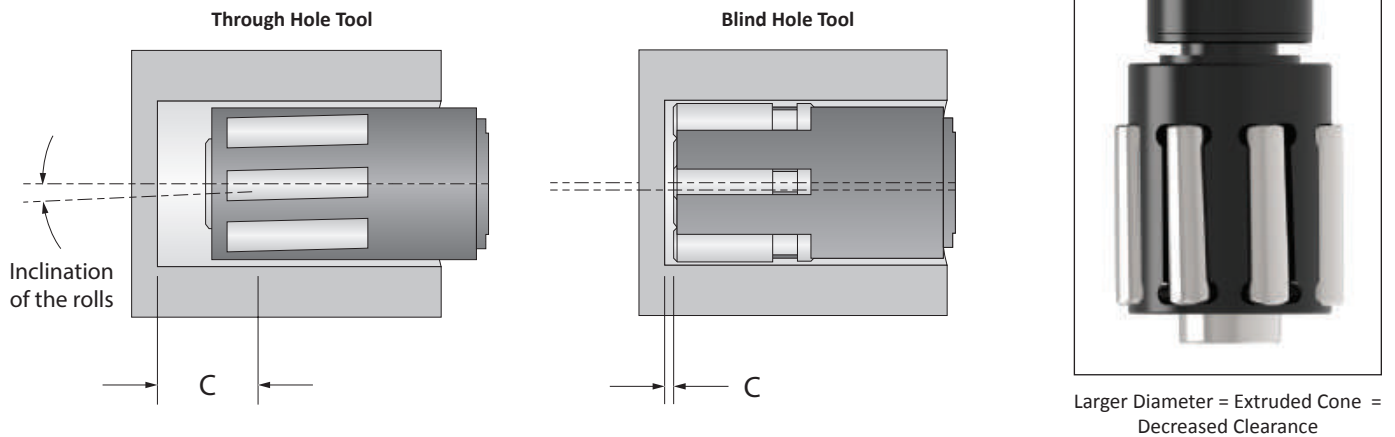

Adjustment Range		Clearance (C)		
		Through Holes		Blind Holes
Imperial (inch)	Metric (mm)	Rolls 701	Rolls 704 / 707	Rolls 708
0.1850 - 0.2315	4.70 - 5.88	–	2.40	–
0.2319 - 0.3728	5.89 - 9.47	–	2.40	0.60
0.3732 - 0.6236	9.48 - 15.84	–	2.40	0.60
0.6240 - 1.1236	15.85 - 28.54	5.40	3.20	1.00
1.1240 - 1.8385	28.55 - 46.70	9.50	3.20	1.00
1.8390 - 3.3386	46.71 - 84.80	9.50	4.00	1.00
3.3390 - 6.5315	84.81 - 165.90	10.30	4.70	1.00

A DRILLING  
B BORING  
C REAMING  
D BURNISHING  
E THREADING  
X SPECIALS



## How it Works

### Roller Burnishing Tools

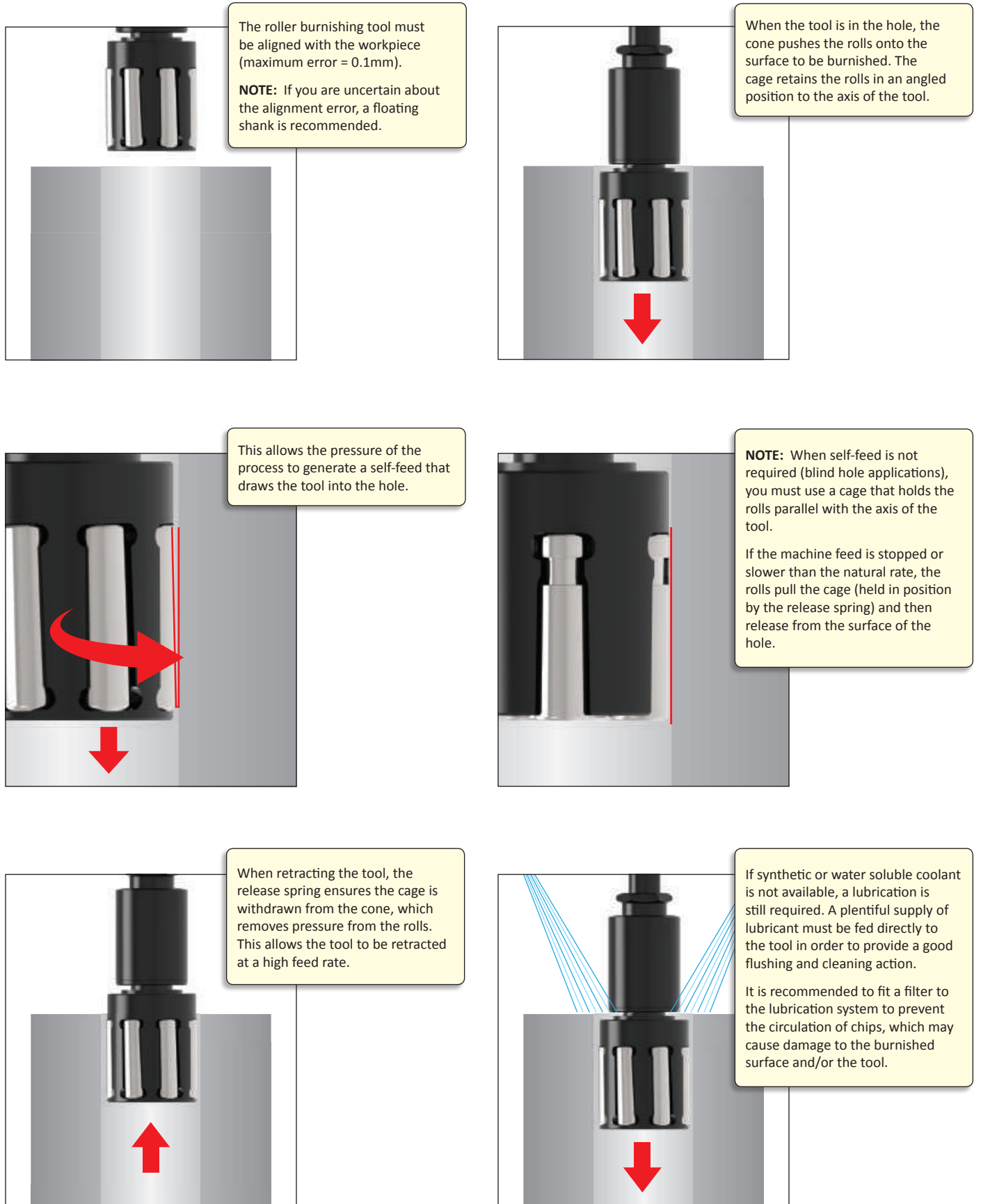

A  
DRILLING  
B  
BORING  
C  
REAMING  
D  
BURNISHING  
E  
THREADING  
X  
SPECIALS

## Recommended Cutting Data | Imperial (inch)

### Roller Burnishing

ISO	Material	Hardness (BHN)	Speed (SFM)	Recommended Feed (IPR) by Burnisher Diameter			
				0.1850 - 0.4724	0.4725 - 0.9843	0.9844 - 1.9685	1.9686 - 6.5315
P	Free Machining Steel 1118, 1215, 12L14, etc.	100 - 180	75 - 300	0.005 - 0.020	0.014 - 0.037	0.032 - 0.086	0.070 - 0.121
		180 - 250	75 - 300	0.005 - 0.020	0.014 - 0.037	0.032 - 0.086	0.070 - 0.121
	Low Carbon Steel 1010, 1020, 1025, 1522, 1144, etc.	85 - 180	75 - 300	0.005 - 0.020	0.014 - 0.037	0.032 - 0.086	0.070 - 0.121
		180 - 275	75 - 300	0.005 - 0.020	0.014 - 0.037	0.032 - 0.086	0.070 - 0.121
	Medium Carbon Steel 1030, 1040, 1050, 1527, 1140, 1151, etc.	125 - 180	75 - 300	0.005 - 0.020	0.014 - 0.037	0.032 - 0.086	0.070 - 0.121
		180 - 325	75 - 300	0.005 - 0.020	0.014 - 0.037	0.032 - 0.086	0.070 - 0.121
	Alloy Steel 4140, 5140, 8640, etc.	125 - 180	75 - 300	0.005 - 0.020	0.014 - 0.037	0.032 - 0.086	0.070 - 0.121
		180 - 375	75 - 300	0.005 - 0.020	0.014 - 0.037	0.032 - 0.086	0.070 - 0.121
	High Strength Alloy 4340, 4330V, 300M, etc.	240 - 450	75 - 300	0.005 - 0.020	0.014 - 0.037	0.032 - 0.086	0.070 - 0.121
	Structural Steel A36, A285, A516, etc.	125 - 180	75 - 300	0.005 - 0.020	0.014 - 0.037	0.032 - 0.086	0.070 - 0.121
	180 - 350	75 - 300	0.005 - 0.020	0.014 - 0.037	0.032 - 0.086	0.070 - 0.121	
Tool Steel H-13, H-21, A-4, O-2, S-3, etc.	150 - 200	75 - 300	0.005 - 0.020	0.014 - 0.037	0.032 - 0.086	0.070 - 0.121	
	200 - 250	75 - 300	0.005 - 0.020	0.014 - 0.037	0.032 - 0.086	0.070 - 0.121	
S	High Temp Alloy Hastelloy B, Inconel 600, etc.	140 - 310	50 - 150	0.005 - 0.020	0.014 - 0.037	0.032 - 0.086	0.070 - 0.121
	Titanium Alloy	140 - 310	50 - 150	0.005 - 0.020	0.014 - 0.037	0.032 - 0.086	0.070 - 0.121
M	Stainless Steel 400 Series 416, 420, etc.	135 - 350	75 - 200	0.005 - 0.020	0.014 - 0.037	0.032 - 0.086	0.070 - 0.121
	Stainless Steel 300 Series 304, 316, 17-4PH, etc.	135 - 275	75 - 200	0.005 - 0.020	0.014 - 0.037	0.032 - 0.086	0.070 - 0.121
K	Grey Cast Iron, Ductile Iron, Spheroidal Cast Iron (Pearlitic)	< 200	75 - 300	0.005 - 0.020	0.014 - 0.037	0.032 - 0.086	0.070 - 0.121
		> 200	75 - 300	0.005 - 0.020	0.014 - 0.037	0.032 - 0.086	0.070 - 0.121
	Spheroidal Cast Iron (Ferritic)	260 - 320	75 - 300	0.005 - 0.020	0.014 - 0.037	0.032 - 0.086	0.070 - 0.121
N	Copper and Alloys	< 500	150 - 350	0.005 - 0.020	0.014 - 0.037	0.032 - 0.086	0.070 - 0.121
	Brass	< 500	150 - 350	0.005 - 0.020	0.014 - 0.037	0.032 - 0.086	0.070 - 0.121
	Bronze	< 180	150 - 350	0.005 - 0.020	0.014 - 0.037	0.032 - 0.086	0.070 - 0.121
	Bronze Phosphorous	< 180	150 - 350	0.005 - 0.020	0.014 - 0.037	0.032 - 0.086	0.070 - 0.121
	Aluminum and Alloys	< 150	150 - 350	0.005 - 0.020	0.014 - 0.037	0.032 - 0.086	0.070 - 0.121

#### Max RPM

Series	Max RPM
H	2000
I	1500
K	1200
L	1000
F	1000
M	900
N	900
O	700
P	600
Q	500
R	300
S	300
T	250
U	200

**IMPORTANT:** The speeds and feeds listed on these pages are a general starting point for all applications. Factory technical assistance is available through our Application Engineering department.

## Stock Allowance | Imperial (inch)

### Roller Burnishing

ISO	Material	Hardness (BHN)	Recommended Stock (inch) by Burnisher Diameter*			
			0.1850 - 0.4724	0.4725 - 0.9843	0.9844 - 1.9685	1.9686 - 6.5315
P	<b>Free Machining Steel</b> 1118, 1215, 12L14, etc.	100 - 180	0.0004 - 0.0007	0.0007 - 0.0016	0.0010 - 0.0018	0.0012 - 0.0020
		180 - 250	0.0004 - 0.0007	0.0007 - 0.0016	0.0010 - 0.0018	0.0012 - 0.0020
	<b>Low Carbon Steel</b> 1010, 1020, 1025, 1522, 1144, etc.	85 - 180	0.0004 - 0.0007	0.0007 - 0.0016	0.0010 - 0.0018	0.0012 - 0.0020
		180 - 275	0.0004 - 0.0007	0.0007 - 0.0016	0.0010 - 0.0018	0.0012 - 0.0020
	<b>Medium Carbon Steel</b> 1030, 1040, 1050, 1527, 1140, 1151, etc.	125 - 180	0.0004 - 0.0007	0.0007 - 0.0016	0.0010 - 0.0018	0.0012 - 0.0020
		180 - 325	0.0004 - 0.0007	0.0005 - 0.0007	0.0005 - 0.0010	0.0008 - 0.0014
	<b>Alloy Steel</b> 4140, 5140, 8640, etc.	125 - 180	0.0004 - 0.0007	0.0007 - 0.0016	0.0010 - 0.0018	0.0012 - 0.0020
		180 - 375	0.0004 - 0.0007	0.0005 - 0.0007	0.0005 - 0.0010	0.0008 - 0.0014
	<b>High Strength Alloy</b> 4340, 4330V, 300M, etc.	240 - 450	0.0004 - 0.0007	0.0005 - 0.0007	0.0005 - 0.0010	0.0008 - 0.0014
	<b>Structural Steel</b> A36, A285, A516, etc.	125 - 180	0.0004 - 0.0007	0.0007 - 0.0016	0.0010 - 0.0018	0.0012 - 0.0020
	180 - 350	0.0004 - 0.0007	0.0005 - 0.0007	0.0005 - 0.0010	0.0008 - 0.0014	
<b>Tool Steel</b> H-13, H-21, A-4, O-2, S-3, etc.	150 - 200	0.0004 - 0.0007	0.0007 - 0.0016	0.0010 - 0.0018	0.0012 - 0.0020	
	200 - 250	0.0004 - 0.0007	0.0005 - 0.0007	0.0005 - 0.0010	0.0008 - 0.0014	
S	<b>High Temp Alloy</b> Hastelloy B, Inconel 600, etc.	140 - 310	0.0004 - 0.0007	0.0005 - 0.0007	0.0005 - 0.0010	0.0008 - 0.0014
	<b>Titanium Alloy</b>	140 - 310	0.0004 - 0.0007	0.0005 - 0.0007	0.0005 - 0.0010	0.0008 - 0.0014
M	<b>Stainless Steel 400 Series</b> 416, 420, etc.	135 - 350	0.0004 - 0.0007	0.0007 - 0.0016	0.0010 - 0.0018	0.0012 - 0.0020
	<b>Stainless Steel 300 Series</b> 304, 316, 17-4PH, etc.	135 - 275	0.0004 - 0.0007	0.0007 - 0.0016	0.0010 - 0.0018	0.0012 - 0.0020
K	<b>Grey Cast Iron, Ductile Iron, Spheroidal Cast Iron (Pearlitic)</b>	< 200	0.0004 - 0.0007	0.0005 - 0.0007	0.0005 - 0.0010	0.0008 - 0.0014
		> 200	0.0004 - 0.0007	0.0005 - 0.0007	0.0005 - 0.0010	0.0008 - 0.0014
	<b>Spheroidal Cast Iron (Ferritic)</b>	260 - 320	0.0004 - 0.0007	0.0005 - 0.0007	0.0005 - 0.0010	0.0008 - 0.0014
N	<b>Copper and Alloys</b> Brass	< 500	0.0004 - 0.0007	0.0007 - 0.0016	0.0010 - 0.0018	0.0012 - 0.0020
	<b>Bronze</b>	< 180	0.0004 - 0.0007	0.0007 - 0.0016	0.0010 - 0.0018	0.0012 - 0.0020
	<b>Bronze Phosphorous</b>	< 180	0.0004 - 0.0007	0.0007 - 0.0016	0.0010 - 0.0018	0.0012 - 0.0020
	<b>Aluminum and Alloys</b>	< 150	0.0004 - 0.0007	0.0007 - 0.0016	0.0010 - 0.0018	0.0012 - 0.0020

\*Stock value is on diameter.

A  
DRILLING  
B  
BORING  
C  
REAMING  
D  
BURNISHING  
E  
THREADING  
X  
SPECIALS

## Recommended Cutting Data | Metric (mm)

### Roller Burnishing

ISO	Material	Hardness (BHN)	Speed (M/min)	Recommended Feed (mm/rev) by Burnisher Diameter			
				4.70 - 12.00	12.01 - 25.00	25.01 - 50.00	50.01 - 165.90
P	Free Machining Steel 1118, 1215, 12L14, etc.	100 - 180	22 - 90	0.13 - 0.51	0.36 - 0.94	0.81 - 2.18	1.78 - 3.07
		180 - 250	22 - 90	0.13 - 0.51	0.36 - 0.94	0.81 - 2.18	1.78 - 3.07
	Low Carbon Steel 1010, 1020, 1025, 1522, 1144, etc.	85 - 180	22 - 90	0.13 - 0.51	0.36 - 0.94	0.81 - 2.18	1.78 - 3.07
		180 - 275	22 - 90	0.13 - 0.51	0.36 - 0.94	0.81 - 2.18	1.78 - 3.07
	Medium Carbon Steel 1030, 1040, 1050, 1527, 1140, 1151, etc.	125 - 180	22 - 90	0.13 - 0.51	0.36 - 0.94	0.81 - 2.18	1.78 - 3.07
		180 - 325	22 - 90	0.13 - 0.51	0.36 - 0.94	0.81 - 2.18	1.78 - 3.07
	Alloy Steel 4140, 5140, 8640, etc.	125 - 180	22 - 90	0.13 - 0.51	0.36 - 0.94	0.81 - 2.18	1.78 - 3.07
		180 - 375	22 - 90	0.13 - 0.51	0.36 - 0.94	0.81 - 2.18	1.78 - 3.07
	High Strength Alloy 4340, 4330V, 300M, etc.	240 - 450	22 - 90	0.13 - 0.51	0.36 - 0.94	0.81 - 2.18	1.78 - 3.07
	Structural Steel A36, A285, A516, etc.	125 - 180	22 - 90	0.13 - 0.51	0.36 - 0.94	0.81 - 2.18	1.78 - 3.07
180 - 350		22 - 90	0.13 - 0.51	0.36 - 0.94	0.81 - 2.18	1.78 - 3.07	
Tool Steel H-13, H-21, A-4, O-2, S-3, etc.	150 - 200	22 - 90	0.13 - 0.51	0.36 - 0.94	0.81 - 2.18	1.78 - 3.07	
	200 - 250	22 - 90	0.13 - 0.51	0.36 - 0.94	0.81 - 2.18	1.78 - 3.07	
S	High Temp Alloy Hastelloy B, Inconel 600, etc.	140 - 310	15 - 45	0.13 - 0.51	0.36 - 0.94	0.81 - 2.18	1.78 - 3.07
	Titanium Alloy	140 - 310	15 - 45	0.13 - 0.51	0.36 - 0.94	0.81 - 2.18	1.78 - 3.07
M	Stainless Steel 400 Series 416, 420, etc.	135 - 350	22 - 60	0.13 - 0.51	0.36 - 0.94	0.81 - 2.18	1.78 - 3.07
	Stainless Steel 300 Series 304, 316, 17-4PH, etc.	135 - 275	22 - 60	0.13 - 0.51	0.36 - 0.94	0.81 - 2.18	1.78 - 3.07
K	Grey Cast Iron, Ductile Iron, Spheroidal Cast Iron (Pearlitic)	< 200	22 - 90	0.13 - 0.51	0.36 - 0.94	0.81 - 2.18	1.78 - 3.07
	Spheroidal Cast Iron (Ferritic)	> 200	22 - 90	0.13 - 0.51	0.36 - 0.94	0.81 - 2.18	1.78 - 3.07
	Spheroidal Cast Iron (Ferritic)	260 - 320	22 - 90	0.13 - 0.51	0.36 - 0.94	0.81 - 2.18	1.78 - 3.07
N	Copper and Alloys Brass	< 500	45 - 105	0.13 - 0.51	0.36 - 0.94	0.81 - 2.18	1.78 - 3.07
	Bronze	< 180	45 - 105	0.13 - 0.51	0.36 - 0.94	0.81 - 2.18	1.78 - 3.07
	Bronze Phosphorous						
	Aluminum and Alloys	< 150	45 - 105	0.13 - 0.51	0.36 - 0.94	0.81 - 2.18	1.78 - 3.07

#### Max RPM

Series	Max RPM
H	2000
I	1500
K	1200
L	1000
F	1000
M	900
N	900
O	700
P	600
Q	500
R	300
S	300
T	250
U	200

**IMPORTANT:** The speeds and feeds listed on these pages are a general starting point for all applications. Factory technical assistance is available through our Application Engineering department.

**Stock Allowance | Metric (mm)**

Roller Burnishing

ISO	Material	Hardness (BHN)	Recommended Stock (mm) by Burnisher Diameter*			
			4.70 - 12.00	12.01 - 25.00	25.01 - 50.00	50.01 - 165.90
P	Free Machining Steel 1118, 1215, 12L14, etc.	100 - 180	0.010 - 0.018	0.018 - 0.041	0.025 - 0.046	0.030 - 0.051
		180 - 250	0.010 - 0.018	0.018 - 0.041	0.025 - 0.046	0.030 - 0.051
	Low Carbon Steel 1010, 1020, 1025, 1522, 1144, etc.	85 - 180	0.010 - 0.018	0.018 - 0.041	0.025 - 0.046	0.030 - 0.051
		180 - 275	0.010 - 0.018	0.018 - 0.041	0.025 - 0.046	0.030 - 0.051
	Medium Carbon Steel 1030, 1040, 1050, 1527, 1140, 1151, etc.	125 - 180	0.010 - 0.018	0.018 - 0.041	0.025 - 0.046	0.030 - 0.051
		180 - 325	0.010 - 0.018	0.012 - 0.018	0.012 - 0.025	0.020 - 0.036
	Alloy Steel 4140, 5140, 8640, etc.	125 - 180	0.010 - 0.018	0.018 - 0.041	0.025 - 0.046	0.030 - 0.051
		180 - 375	0.010 - 0.018	0.012 - 0.018	0.012 - 0.025	0.020 - 0.036
	High Strength Alloy 4340, 4330V, 300M, etc.	240 - 450	0.010 - 0.018	0.012 - 0.018	0.012 - 0.025	0.020 - 0.036
	Structural Steel A36, A285, A516, etc.	125 - 180	0.010 - 0.018	0.018 - 0.041	0.025 - 0.046	0.030 - 0.051
180 - 350		0.010 - 0.018	0.012 - 0.018	0.012 - 0.025	0.020 - 0.036	
Tool Steel H-13, H-21, A-4, O-2, S-3, etc.	150 - 200	0.010 - 0.018	0.018 - 0.041	0.025 - 0.046	0.030 - 0.051	
	200 - 250	0.010 - 0.018	0.012 - 0.018	0.012 - 0.025	0.020 - 0.036	
S	High Temp Alloy Hastelloy B, Inconel 600, etc.	140 - 310	0.010 - 0.018	0.012 - 0.018	0.012 - 0.025	0.020 - 0.036
	Titanium Alloy	140 - 310	0.010 - 0.018	0.012 - 0.018	0.012 - 0.025	0.020 - 0.036
M	Stainless Steel 400 Series 416, 420, etc.	135 - 350	0.010 - 0.018	0.018 - 0.041	0.025 - 0.046	0.030 - 0.051
	Stainless Steel 300 Series 304, 316, 17-4PH, etc.	135 - 275	0.010 - 0.018	0.018 - 0.041	0.025 - 0.046	0.030 - 0.051
K	Grey Cast Iron, Ductile Iron, Spheroidal Cast Iron (Pearlitic)	< 200	0.010 - 0.018	0.012 - 0.018	0.012 - 0.025	0.020 - 0.036
		> 200	0.010 - 0.018	0.012 - 0.018	0.012 - 0.025	0.020 - 0.036
	Spheroidal Cast Iron (Ferritic)	260 - 320	0.010 - 0.018	0.012 - 0.018	0.012 - 0.025	0.020 - 0.036
N	Copper and Alloys Brass	< 500	0.010 - 0.018	0.018 - 0.041	0.025 - 0.046	0.030 - 0.051
	Bronze	< 180	0.010 - 0.018	0.018 - 0.041	0.025 - 0.046	0.030 - 0.051
	Bronze Phosphorous	< 180	0.010 - 0.018	0.018 - 0.041	0.025 - 0.046	0.030 - 0.051
	Aluminum and Alloys	< 150	0.010 - 0.018	0.018 - 0.041	0.025 - 0.046	0.030 - 0.051

\*Stock value is on diameter.

A  
DRILLING  
B  
BORING  
C  
REAMING  
D  
BURNISHING  
E  
THREADING  
X  
SPECIALS



SECTION

---

E

---

Threading

# Threading Solutions

Solid Carbide and Indexable Thread Mills | AccuThread™ 856 | ThreadMills USA



## Any Thread, Any Time

Allied Machine's thread milling product line has developed into a comprehensive range of high precision tooling that offers outstanding productivity with exceptional levels of tool life and thread accuracy. The thread mill range covers both solid carbide and indexable replaceable insert tools with an extensive range of thread forms.

Our thread milling product line has been specifically designed to provide customers with a wide range of options. This is achieved by offering two thread mill ranges within our product lineup: the low cost, general production ThreadMills USA range, and the high performance, high productivity AccuThread™ range.

Online programmer available 24/7	Solid carbide and indexable insert styles	Large range of thread form options
----------------------------------	---	------------------------------------

## Applicable Industries



Aerospace



Agriculture



Automotive



Firearms



General Machining



Medical



Oil & Gas



Renewable Energy



Tool, Mold & Die

Your safety and the safety of others is very important. This catalog contains important safety messages. Always read and follow all safety precautions.



This triangle is a safety hazard symbol. It alerts you to potential safety hazards that can cause tool failure and serious injury.

When you see this symbol in the catalog, look for a related safety message that may be near this triangle or referred to in the nearby text.

There are safety signal words also used in the catalog. Safety messages follow these words.

### **WARNING**

**WARNING** (shown above) means that failure to follow the precautions in this message could result in tool failure and serious injury.

**NOTICE** means that failure to follow the precautions in this message could result in damage to the tool or machine but not result in personal injury.

**NOTE** and **IMPORTANT** are also used. These are important that you read and follow but are not safety-related.

Visit [www.alliedmachine.com](http://www.alliedmachine.com) for the most up-to-date information and procedures.



## Reference Icons

The following icons will appear throughout the catalog to help you navigate between products.

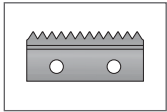

### Bolt-in Style Inserts

Refers to the available bolt-in style thread mill insert options

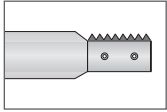

### Bolt-in Style Insert Holders

Refers to the range of holder options available for bolt-in style inserts

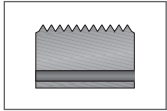

### Pin Style Inserts

Refers to the available pin style thread mill insert options.

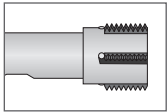

### Pin Style Insert Holders

Refers to the range of holder options available for pin style inserts



### Setup / Assembly Information

Detailed instructions and information regarding the corresponding part(s)

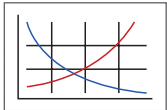

### Recommended Cutting Data

Speed and feed recommendations for optimum and safe threading



### Coolant Through Option

Indicates that the product is coolant through

## Introduction Information

Thread Mills Overview and Online Tools . . . . .	2 - 3
--	-------

## Solid Carbide Thread Mills

Product Overview . . . . .	4
Port and Thread Finishing Kits . . . . .	5
Product Nomenclature . . . . .	6 - 7
BSW Thread Form . . . . .	8 - 9
BSPT Thread Form . . . . .	10
BSPP Thread Form . . . . .	11
NPT Thread Form . . . . .	12 - 13
NPTF Thread Form . . . . .	14 - 15
NPS Thread Form . . . . .	16
NPSF Thread Form . . . . .	17
UN Thread Form . . . . .	18 - 25
ISO Thread Form . . . . .	26 - 29
UN Thread Form (AccuThread T3) . . . . .	30 - 31
ISO Thread Form (AccuThread T3) . . . . .	32 - 33

## Indexable Thread Mills

Product Overview . . . . .	34
Product Nomenclature . . . . .	35
<i>Bolt-in Style:</i>	
NPT / NPTF Thread Forms . . . . .	36
BSPT / BSPP Thread Forms . . . . .	37
UN Thread Form . . . . .	38
UNJ Thread Form . . . . .	39
ISO Thread Form . . . . .	40
Holdings . . . . .	41
<i>Pin Style:</i>	
NPT / NPTF / BSPT Thread Forms . . . . .	42
BSPP / API-ROUND / ACME Thread Forms . . . . .	43
UN Thread Form . . . . .	44 - 45
UNJ Thread Form . . . . .	46
ISO Thread Form . . . . .	47
Holdings . . . . .	48 - 49









## Recommended Cutting Data

Pre-Drill Information, Formulas and Recommended Pass Chart . . . . .	50 - 51
Solid Carbide: AccuThread™ 856 . . . . .	52 - 53
Solid Carbide: ThreadMills USA . . . . .	54 - 55
Solid Carbide: AccuThread™ T3 . . . . .	56 - 57
Indexable: AccuThread™ 856 . . . . .	58 - 61
Programming Guide . . . . .	62 - 63
AccuThread T3 Technical Guide . . . . .	64
Troubleshooting Guide . . . . .	66 - 67

## High Performance Threading Solutions

# THREAD MILLING DONE *RIGHT*

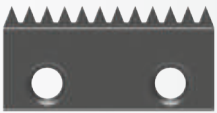

Solid Carbide Thread Mills		Notes
<b>AccuThread™ 856</b> 		<ul style="list-style-type: none"> <li>• Allied Machine's proprietary AM210® coating yields a 25-50% increase in tool life over competitor products</li> <li>• Standard cutting lengths allow for multiple applications without the need for special thread mills</li> <li>• Helical flute offers increased strength and rigidity when cutting forces are applied</li> </ul>
<b>ThreadMills USA</b> 		<ul style="list-style-type: none"> <li>• Helical flute offers increased strength and rigidity when cutting forces are applied</li> <li>• High quality for consistent, predictable production</li> <li>• Coolant through options available</li> <li>• TiAlN coating improves tool life versus uncoated tools </li> </ul>
<b>AccuThread™ T3</b> 		<ul style="list-style-type: none"> <li>• Allied Machine's proprietary AM210® coating yields a 25-50% increase in tool life over competitor products</li> <li>• Standard cutting lengths allow for multiple applications without the need for special thread mills</li> <li>• Helical flute offers increased strength and rigidity when cutting forces are applied</li> </ul>
Indexable Insert Thread Mills		Notes
<b>AccuThread™ 856 Bolt-in Style</b> 		<ul style="list-style-type: none"> <li>• Thread mill holders are manufactured from stainless steel that is engineered to dampen vibration during operation</li> <li>• Extensive range of thread forms with two thread lengths</li> <li>• Can produce left or right handed threads</li> </ul>
<b>AccuThread™ 856 Pin Style</b> 		<ul style="list-style-type: none"> <li>• Patented pin style locking system ensures unsurpassed repeatability</li> <li>• Thread mill holders are manufactured from stainless steel that is engineered to dampen vibration during operation</li> <li>• Extensive range of thread forms with two thread lengths</li> </ul>
<b>AccuThread™ 856 Indexable Inserts</b>  	<p>Bolt-in Style</p> <p>Pin Style</p>	<ul style="list-style-type: none"> <li>• Full profiles present on all inserts allow 100% thread form against 65-75% for tapping</li> <li>• Allied Machine's premium carbide allows for extended tool life while providing high quality thread forms</li> <li>• Allied Machine's proprietary AM210® coating yields a 25-50% increase in tool life over competitor products</li> </ul>

A DRILLING  
B BORING  
C REAMING  
D BURNISHING  
E THREADING  
X SPECIALS

Online Tools

# Insta-Code®

Find your thread mill. Create your program.

The all new software lets you choose the best thread mill product for your application and create the program code for your machine. Insta-Code is available as a PC download app (that can be used offline) and an online web app available 24/7 at [www.alliedmachine.com/InstaCode](http://www.alliedmachine.com/InstaCode).

Eliminate the wait. Get your program now.



Insta-Code also has a **Cycle Time Calculator**



### Online Version



- Generates thread mill G-code programs
- Available online 24/7
- No log-in required
- No updates needed
- Easily share the program code
- Supported on all web browsers

### Download Version



- Creates program code for multiple machine platforms
- Suggests a thread mill based on application details
- Provides estimated cycle time for improved production
- Available for use offline

### Offline Version Updates









- Update your offline Insta-Code software
- Download the updated .zip file, then transfer to the offline computer. Click "check for update" in your Insta-Code software and navigate to the downloaded .zip file
- This allows you to keep all your saved programs

<p><b>1</b></p> <p>Download and open <b>Allied_Machine_Insta-Code.zip</b></p>	<p><b>2</b></p> <p>Click on <b>setup.exe</b> to install the program</p>	<p><b>3</b></p> <p><b>One click updates</b> are available for online computers</p>
---	---	--

 Supported on all Windows OS

[www.alliedmachine.com/InstaCode](http://www.alliedmachine.com/InstaCode)

## Solid Carbide Styles and Thread Forms

	Straight BSW	Helical BSPP, NPS, NPSF, UN, ISO	Taper Helical BSPT, NPT, NPTF	Helical (3-Tooth Style) UN, ISO
<b>A</b> DRILLING	 AccuThread™ 856	 AccuThread™ 856	 AccuThread™ 856	 AccuThread™ T3
<b>B</b> BORING	 ThreadMills USA™ (coolant and non-coolant)	 ThreadMills USA™ (coolant and non-coolant)	 ThreadMills USA™ (coolant and non-coolant)	

# AccuThread™ T3

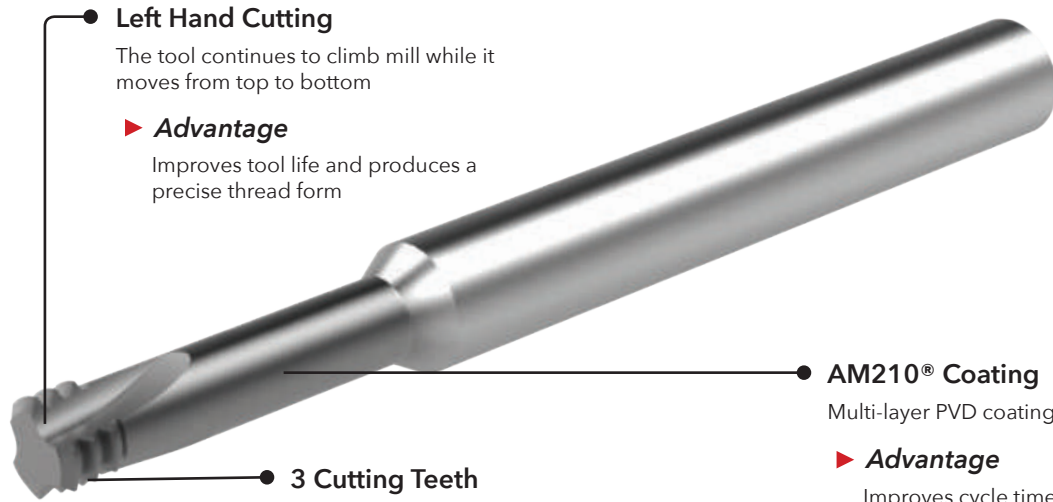

- Left Hand Cutting**  
 The tool continues to climb mill while it moves from top to bottom  
 ► **Advantage**  
 Improves tool life and produces a precise thread form
- AM210® Coating**  
 Multi-layer PVD coating  
 ► **Advantage**  
 Improves cycle times and tool life
- 3 Cutting Teeth**  
 The tool cuts minimal threads at once and reduces side deflection  
 ► **Advantage**  
 Cuts harder materials, and produces deeper threads than a standard thread mill

### Additional Information

- Available in UN and ISO thread forms
- Available in imperial and metric shanks
- Available in 2xD and 3xD lengths

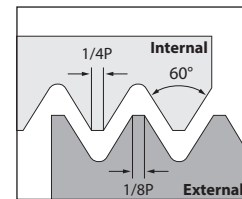
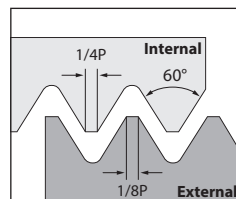

Port and Thread Finishing Kits



# WE HAVE A **KIT** FOR THAT

Kits aren't for everyone, but if you work on different projects from day to day, you need to ***be prepared for the work tomorrow will bring.***

**The Complete Package**

Producing fully finished threaded hydraulic ports has never been easier. The Port and Thread Finishing Kit includes the AccuPort 432® port contour cutter with a dedicated AccuThread 856 solid carbide thread mill in a single kit. You also receive the T-A® inserts and port form inserts needed to complete the assembly.

Port kits incorporate the AccuThread 856 solid carbide thread mills to increase the manufacturing flexibility by allowing hydraulic ports to be produced in just two operations. In addition, where a unique port profile is required, Allied Machine provides a dedicated special tooling solution using our extensive tool design and manufacturing experience to meet precise specifications.

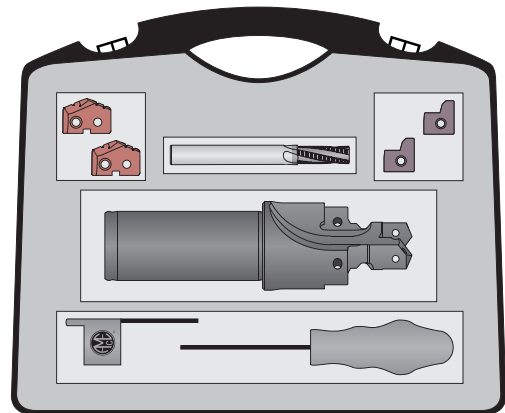

**NOTE:** See Section A92 of our product catalog for the complete list of Port and Thread Finishing Kits.



**One Tool, **FOUR** Operations**

- Spot Face
- Port Contour
- Tap Drill
- Spot Drill



**NOTE:** See Section A92 of our product catalog for full AccuPort 432 product line information.

## Product Nomenclature

### AccuThread™ 856 Solid Carbide Thread Mills

<b>TM</b>	<b>U</b>	<b>K</b>	<b>0250</b>	-	<b>20</b>	<b>M</b>
1	2	3	4		5	6



1. Thread Mill	2. Thread Class	3. Coating	4. Min Thread Diameter	5. Thread Pitch	6. Shank
<b>TM</b> = Standard <b>HDTM</b> = Heavy duty <b>TW</b> = Weldon flat	<b>U</b> = UN <b>N</b> = NPT, NPTF <b>B</b> = BSPP, BSPT, BSW <b>M</b> = ISO <b>A</b> = AccuPort® specific	<b>K</b> = AM210® <b>U</b> = Uncoated	<b>0250</b> = 1/4 (English) <b>0008</b> = #8 (Number Drill) <b>0450</b> = M4.5 (ISO)	<b>20</b> = UN 20 TPI <b>075</b> = ISO 0.75 <b>NPT</b> = All pipe threads will show thread form	<b>Blank</b> = Imperial <b>M</b> = Metric

### ThreadMills USA™ Solid Carbide Thread Mills

<b>TM</b>	<b>250</b>	<b>20</b>	<b>CH</b>	<b>M</b>
1	2	3	4	5



1. Thread Mill	2. Min Thread Diameter	3. Thread Pitch	4. Optional	5. Shank
<b>TM</b> = TiAlN <b>TMFT</b> = Uncoated <b>HDTM</b> = Heavy duty <b>HDTMFT</b> = Heavy duty uncoated	<b>250</b> = 1/4 (English) <b>08</b> = #8 (Number Drill) <b>45</b> = M4.5 (ISO)	<b>20</b> = UN 20 TPI <b>075</b> = ISO 0.75 <b>NPT</b> = All pipe threads will show thread form	<b>CH</b> = Coolant hole <b>DE</b> = Double end <b>NPT</b> = All pipe threads will show thread form	<b>Blank</b> = Imperial <b>M</b> = Metric

#### Reference Key

Symbol	Attribute
$D_1$	Maximum cutter diameter
$D_2$	Shank diameter
$L_1$	Overall length
$L_6$	Length of cut

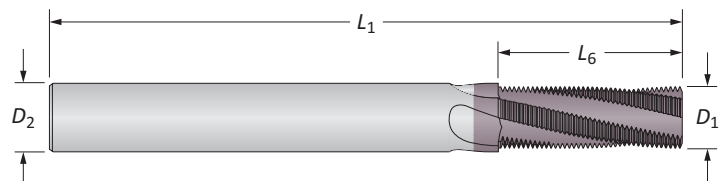



Product Nomenclature

AccuThread™ T3 Solid Carbide Thread Mills

<b>TM</b>	<b>073</b>	<b>64</b>	<b>M</b>	-	<b>3T</b>	<b>2X</b>
1	2	3	4		5	6



1. Thread Mill	2. Min Thread Diameter	3. Pitch	4. Shank	5. Style	6. Depth to Diameter Ratio
TM = Standard	250 = 1/4 (English) 45 = M4.5 (Metric)	20 = UN 20 TPI 075 = Metric 0.75	Blank = Imperial M = Metric	3T = 3 tooth	2X = 2xD 3X = 3xD

Reference Key

Symbol	Attribute
$D_1$	Maximum cutter diameter
$D_2$	Shank diameter
$D_3$	Undercut diameter
$L_1$	Overall length
$L_6$	Length of cut

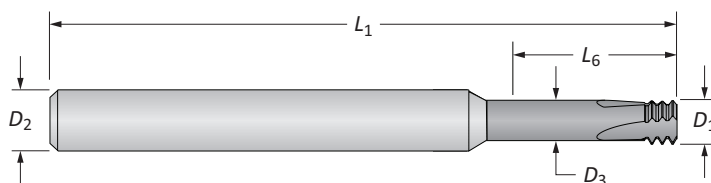

A

DRILLING

B

BORING

C

REAMING

D

BURNISHING

E

THREADING

X

SPECIALS

## Solid Carbide Thread Mills

BSW | Non-Coolant

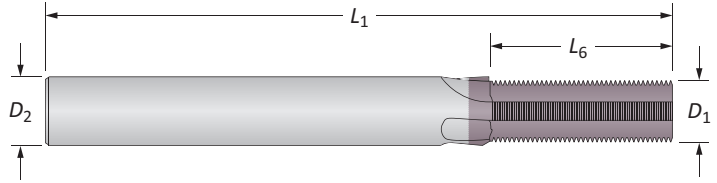
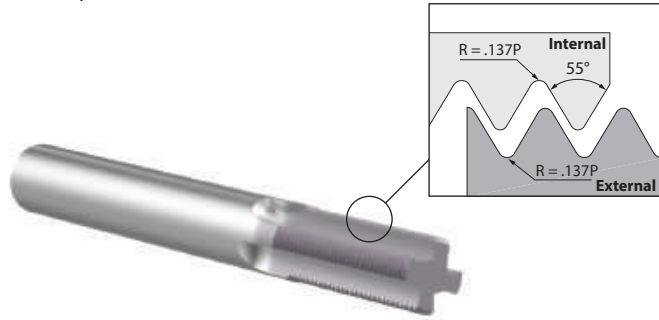

BSW | Non-Coolant

TPI (Pitch)	Min Thread Ø	Flutes	Thread Mill				Part No.	
			$D_1$	$D_2$	$L_6$	$L_1$	ThreadMills USA	AccuThread™ 856
20	1/4	3	0.177	0.250	0.400	2.500	<b>TM20BSW</b>	-
18	5/16	3	0.197	0.250	0.445	2.500	<b>TM18BSW</b>	-
16	3/8	5	0.276	0.312	0.563	3.000	<b>TM16BSW</b>	-
14	7/16	5	0.311	0.312	0.715	3.000	<b>TM14BSW</b>	-
<b>i</b> 12	1/2	5	0.354	0.375	0.750	3.500	<b>TM12BSW</b>	-
11	5/8	5	0.468	0.500	0.910	3.500	<b>TM11BSW</b>	-
10	3/4	5	0.468	0.500	1.100	3.500	<b>TM10BSW</b>	-
9	7/8	6	0.620	0.625	1.112	4.000	<b>TM9BSW</b>	-
8	1	6	0.620	0.625	1.375	4.000	<b>TM8BSW</b>	-
20	1/4	3	4.50	6.00	10.16	58.00	<b>TM20BSWM</b>	<b>TMBK0250-20M</b>
18	5/16	3	5.00	6.00	11.29	58.00	<b>TM18BSWM</b>	<b>TMBK0312-18M</b>
16	3/8	5	7.00	8.00	14.29	64.00	<b>TM16BSWM</b>	<b>TMBK0375-16M</b>
14	7/16	5	7.90	8.00	18.15	64.00	<b>TM14BSWM</b>	<b>TMBK0437-14M</b>
<b>m</b> 12	1/2	5	9.00	10.00	19.10	73.00	<b>TM12BSWM</b>	<b>TMBK0500-12M</b>
11	5/8	5	11.90	12.00	23.10	84.00	<b>TM11BSWM</b>	<b>TMBK0625-11M</b>
10	3/4	5	11.90	12.00	27.94	84.00	<b>TM10BSWM</b>	<b>TMBK0750-10M</b>
9	7/8	6	15.90	16.00	28.23	93.00	<b>TM9BSWM</b>	<b>TMBK0875-9M</b>
8	1	6	15.90	16.00	34.94	93.00	<b>TM8BSWM</b>	<b>TMBK1000-8M</b>

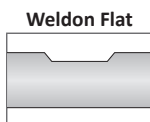
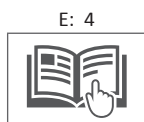
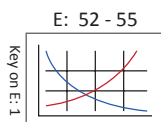

To order a thread mill with a Weldon flat, replace the leading TM designator with TW (available for inch shanks 3/8 and above, or metric shanks 6mm and above)  
**Example:** Cylindrical shank = **TW**NK0500-NPT | Weldon shank flat = **TWN**K0500-NPT  
**NOTE:** Weldon flats have a minimum order quantity of 2 pieces

**i** = Imperial (in)  
**m** = Metric (mm)

A DRILLING  
 B BORING  
 C REAMING  
 D BURNISHING  
 E THREADING  
 X SPECIALS





### Solid Carbide Thread Mills

BSW | Coolant Through

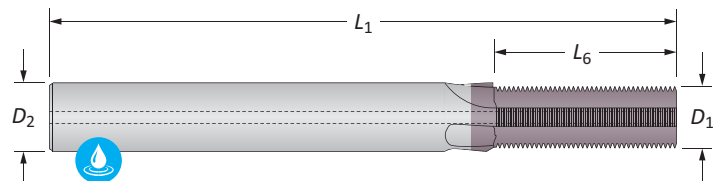
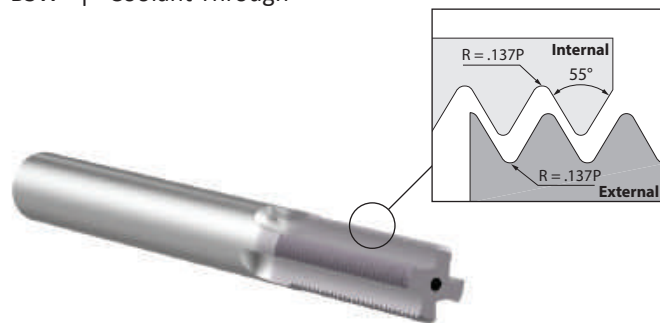

BSW | Coolant Through

	TPI (Pitch)	Min Thread Ø	Flutes	Thread Mill				Part No.
				D <sub>1</sub>	D <sub>2</sub>	L <sub>6</sub>	L <sub>1</sub>	ThreadMills USA
i	20	1/4	3	0.177	0.250	0.400	2.375	TM20BSWCH
	18	5/16	3	0.197	0.250	0.445	2.375	TM18BSWCH
	16	3/8	5	0.276	0.312	0.563	3.000	TM16BSWCH
	14	7/16	5	0.311	0.312	0.715	3.000	TM14BSWCH
	12	1/2	5	0.354	0.375	0.750	3.000	TM12BSWCH
	11	5/8	5	0.468	0.500	0.910	3.500	TM11BSWCH
	10	3/4	5	0.468	0.500	1.100	3.500	TM10BSWCH
	9	7/8	6	0.620	0.625	1.112	4.000	TM9BSWCH
	8	1	6	0.620	0.625	1.375	4.000	TM8BSWCH
m	20	1/4	3	4.50	6.00	10.16	58.00	TM20BSWCHM
	18	5/16	3	5.00	6.00	11.29	58.00	TM18BSWCHM
	16	3/8	5	7.00	8.00	14.29	64.00	TM16BSWCHM
	14	7/16	5	7.90	8.00	18.15	64.00	TM14BSWCHM
	12	1/2	5	9.00	10.00	19.10	84.00	TM12BSWCHM
	11	5/8	5	11.90	12.00	23.10	84.00	TM11BSWCHM
	10	3/4	5	11.90	12.00	27.94	84.00	TM10BSWCHM
	9	7/8	6	15.90	16.00	28.23	93.00	TM9BSWCHM
	8	1	15.90	16.00	34.94	93.00	TM8BSWCHM	

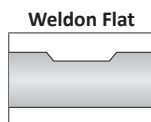
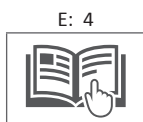
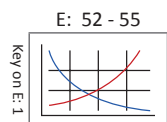

To order a thread mill with a Weldon flat, replace the leading TM designator with TW (available for inch shanks 3/8 and above, or metric shanks 6mm and above)  
**Example:** Cylindrical shank = **TM**NK0500-NPT | Weldon shank flat = **TW**NK0500-NPT  
**NOTE:** Weldon flats have a minimum order quantity of 2 pieces



i = Imperial (in)  
 m = Metric (mm)

## Solid Carbide Thread Mills

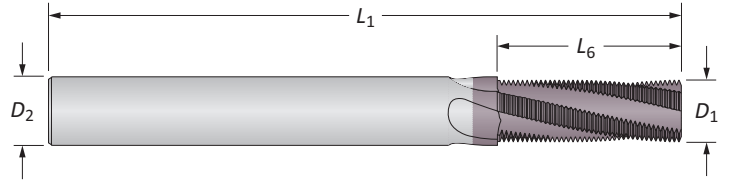
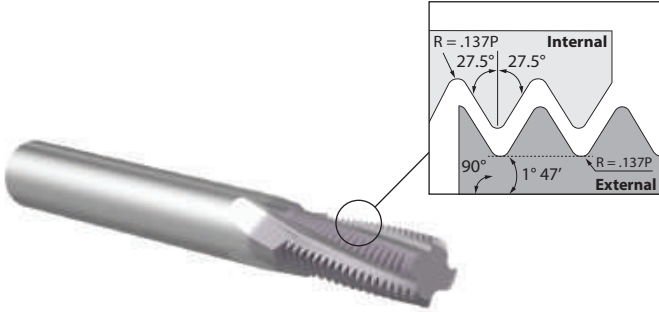
BSPT

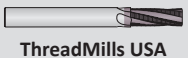

BSPT | Non-Coolant

	TPI (Pitch)	Min Thread $\phi$	Flutes	Thread Mill				Part No.	
				$D_1$	$D_2$	$L_6$	$L_1$	 ThreadMills USA	 AccuThread™ 856
i	28	1/16 and 1/8	3	0.240	0.250	0.393	2.500	TM28BSPT	-
	19	1/4 and 3/8	4	0.310	0.312	0.580	3.000	TM19BSPT	-
	14	1/2 and 3/4	4	0.470	0.500	0.787	3.500	TM14BSPT	-
	11	1	4	0.620	0.625	1.546	4.000	TM11BSPT	-
m	28	1/16 and 1/8	3	5.97	6.00	9.98	58.00	TM28BSPTM	TMBK0063-BSPTM
	19	1/4 and 3/8	4	9.91	10.00	14.73	73.00	TM19BSPTM	TMBK0250-BSPTM
	14	1/2 and 3/4	4	11.94	12.00	20.00	84.00	TM14BSPTM	TMBK0500-BSPTM
	11	1	4	15.75	16.00	32.31	93.00	TM11BSPTM	TMBK1000-BSPTM

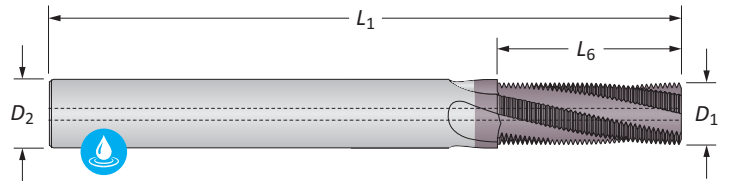
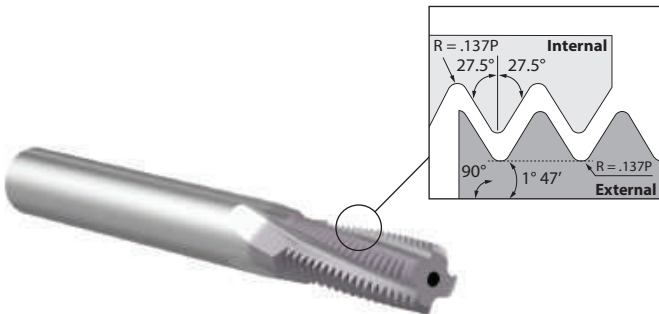

BSPT | Coolant Through

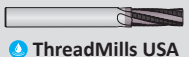
	TPI (Pitch)	Min Thread $\phi$	Flutes	Thread Mill				Part No.
				$D_1$	$D_2$	$L_6$	$L_1$	 ThreadMills USA
i	28	1/16 and 1/8	3	0.240	0.250	0.393	2.375	TM28BSPTCH
	19	1/4 and 3/8	4	0.310	0.312	0.580	3.000	TM19BSPTCH
	14	1/2 and 3/4	4	0.470	0.500	0.787	3.500	TM14BSPTCH
	11	1	4	0.620	0.625	1.546	4.000	TM11BSPTCH
m	28	1/16 and 1/8	3	5.97	6.00	9.98	58.00	TM28BSPTCHM
	19	1/4 and 3/8	4	9.91	10.00	14.73	84.00	TM19BSPTCHM
	14	1/2 and 3/4	4	11.94	12.00	20.00	84.00	TM14BSPTCHM
	11	1	4	15.75	16.00	32.31	93.00	TM11BSPTCHM

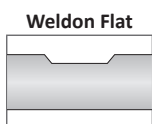
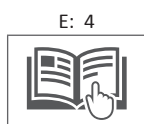
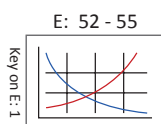

To order a thread mill with a Weldon flat, replace the leading TM designator with TW (available for inch shanks 3/8 and above, or metric shanks 6mm and above)  
**Example:** Cylindrical shank = **TW**NK0500-NPT | Weldon shank flat = **TWN**K0500-NPT  
**NOTE:** Weldon flats have a minimum order quantity of 2 pieces

i = Imperial (in)  
 m = Metric (mm)

A DRILLING  
 B BORING  
 C REAMING  
 D BURNISHING  
 E THREADING  
 X SPECIALS



## Solid Carbide Thread Mills

### BSPB

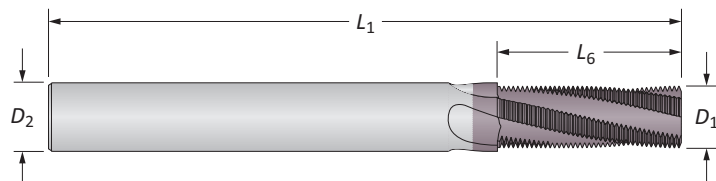
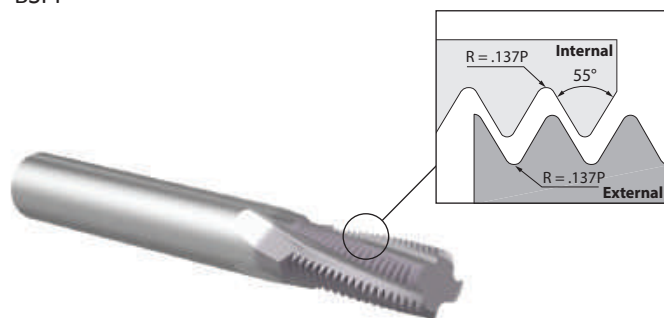

### BSPB | Non-Coolant

	TPI (Pitch)	Min Thread Ø	Flutes	Thread Mill				Part No.	
				D <sub>1</sub>	D <sub>2</sub>	L <sub>6</sub>	L <sub>1</sub>	ThreadMills USA	AccuThread™ 856
i	28	1/16 and 1/8	3	0.240	0.250	0.572	2.500	TM28BSPP	–
	19	1/4 and 3/8	4	0.310	0.312	0.737	3.000	TM19BSPP	–
	14	1/2 and 3/4	4	0.470	0.500	1.143	3.500	TM14BSPP	–
	11	1	4	0.620	0.625	1.365	4.000	TM11BSPP	–
m	28	1/16 and 1/8	3	5.97	6.00	14.53	58.00	TM28BSPPM	TMBK0063-BSPPM
	19	1/4 and 3/8	4	9.91	10.00	18.72	73.00	TM19BSPPM	TMBK0250-BSPPM
	19	3/8	4	11.94	12.00	28.41	84.00	HDTM19BSPPM	–
	14	1/2 and 3/4	4	11.94	12.00	29.03	84.00	TM14BSPPM	TMBK0500-BSPPM
	14	3/4	5	15.75	16.00	34.47	93.00	HDTM14BSPPM	–
	11	1	4	15.75	16.00	34.67	93.00	TM11BSPPM	TMBK1000-BSPPM

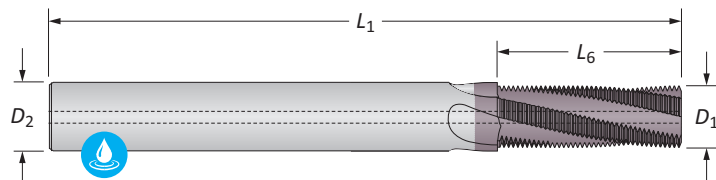
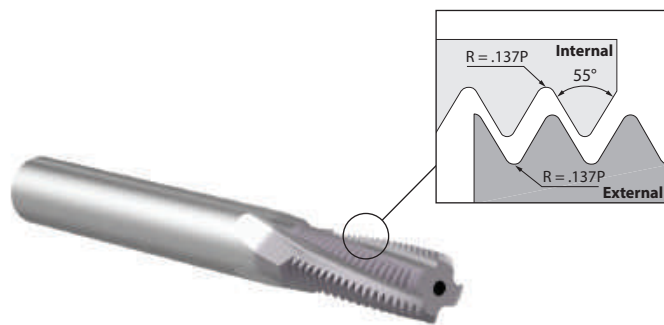

### BSPB | Coolant Through

	TPI (Pitch)	Min Thread Ø	Flutes	Thread Mill				Part No.
				D <sub>1</sub>	D <sub>2</sub>	L <sub>6</sub>	L <sub>1</sub>	ThreadMills USA
i	28	1/16 and 1/8	3	0.240	0.250	0.572	2.375	TM28BSPPCH
	19	1/4 and 3/8	4	0.310	0.312	0.737	3.000	TM19BSPPCH
	14	1/2 and 3/4	4	0.470	0.500	1.143	3.500	TM14BSPPCH
	11	1	4	0.620	0.625	1.365	4.000	TM11BSPPCH
m	28	1/16 and 1/8	3	5.97	6.00	14.53	58.00	TM28BSPPCHM
	19	1/4 and 3/8	4	9.91	10.00	18.72	84.00	TM19BSPPCHM
	14	1/2 and 3/4	4	11.94	12.00	29.03	84.00	TM14BSPPCHM
	11	1	4	15.75	16.00	34.67	93.00	TM11BSPPCHM

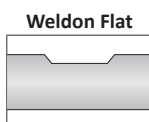
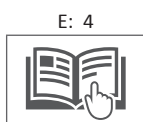
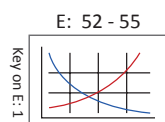

To order a thread mill with a Weldon flat, replace the leading TM designator with TW (available for inch shanks 3/8 and above, or metric shanks 6mm and above)  
**Example:** Cylindrical shank = **TM**NK0500-NPT | Weldon shank flat = **TW**NK0500-NPT  
**NOTE:** Weldon flats have a minimum order quantity of 2 pieces

i = Imperial (in)  
 m = Metric (mm)

Solid Carbide Thread Mills

NPT | Non-Coolant

A DRILLING

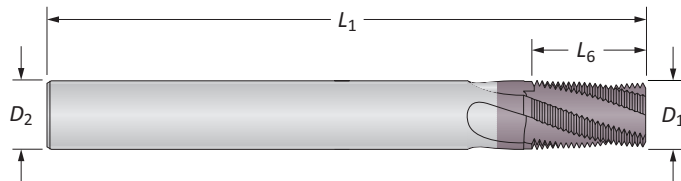
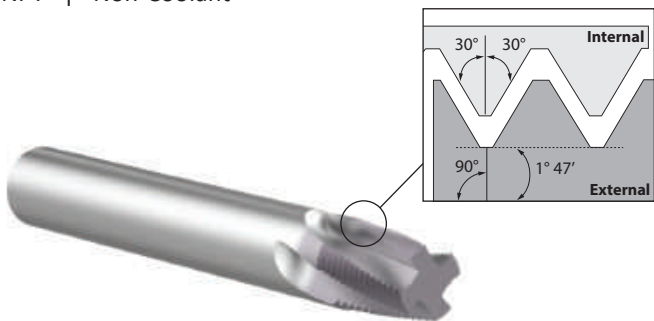

B BORING

NPT | Non-Coolant

C REAMING

TPI (Pitch)	Min Thread Ø	Flutes	Thread Mill				Part No.	
			D <sub>1</sub>	D <sub>2</sub>	L <sub>6</sub>	L <sub>1</sub>	ThreadMills USA	AccuThread™ 856
27	1/16 and 1/8	3	0.245	0.250	0.437	2.500	TM27NPT	TMNK0063-NPT
27	1/8	4	0.300	0.312	0.482	3.000	HDTM27NPT	HDTMNK0125-NPT
18	1/4 and 3/8	4	0.305	0.312	0.625	3.000	TM18NPT	TMNK0250-NPT
18	1/4 and 3/8	4	0.363	0.375	0.680	3.500	HDTM18NPT	HDTMNK0250-NPT
<b>i</b> 14	1/2 and 3/4	4	0.495	0.500	0.875	3.500	TM14NPT	TMNK0500-NPT
14	3/4	4	0.620	0.625	1.000	4.000	HDTM14NPT	HDTMNK0750-NPT
11.5	1	4	0.620	0.625	1.125	4.000	TM11NPT	TMNK1000-NPT
11.5	1	5	0.745	0.750	1.219	4.000	HDTM11NPT	HDTMNK1000-NPT
8	2-1/2	4	0.745	0.750	1.500	5.000	TM8NPT	TMNK2500-NPT
27	1/16 and 1/8	3	5.95	6.00	11.30	58.00	TM27NPTM	TMNK0063-NPTM
27	1/8	4	7.62	8.00	12.25	64.00	HDTM27NPTM	-
18	1/4 and 3/8	4	7.75	8.00	15.70	64.00	TM18NPTM	TMNK0250-NPTM
18	1/4 and 3/8	4	9.22	10.00	17.25	84.00	HDTM18NPTM	-
<b>m</b> 14	1/2 and 3/4	4	11.95	12.00	23.70	84.00	TM14NPTM	TMNK0500-NPTM
14	3/4	4	15.75	16.00	25.40	93.00	HDTM14NPTM	-
11.5	1	4	15.75	16.00	28.75	93.00	TM11NPTM	TMNK1000-NPTM
11.5	1	5	18.92	20.00	30.95	105.00	HDTM11NPTM	-
8	2-1/2	5	19.75	20.00	38.10	115.00	TM8NPTM	TMNK2500-NPTM

D BURNISHING

E THREADING

X SPECIALS

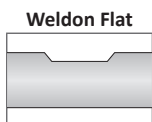
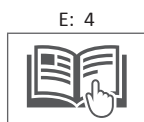
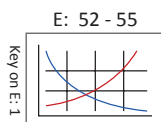

To order a thread mill with a Weldon flat, replace the leading TM designator with TW (available for inch shanks 3/8 and above, or metric shanks 6mm and above)  
**Example:** Cylindrical shank = **TM**NK0500-NPT | Weldon shank flat = **TWN**K0500-NPT  
**NOTE:** Weldon flats have a minimum order quantity of 2 pieces

**i** = Imperial (in)  
**m** = Metric (mm)



### Solid Carbide Thread Mills

NPT | Coolant Through

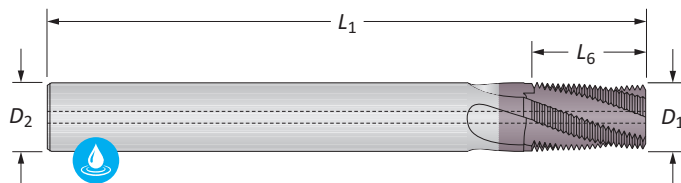
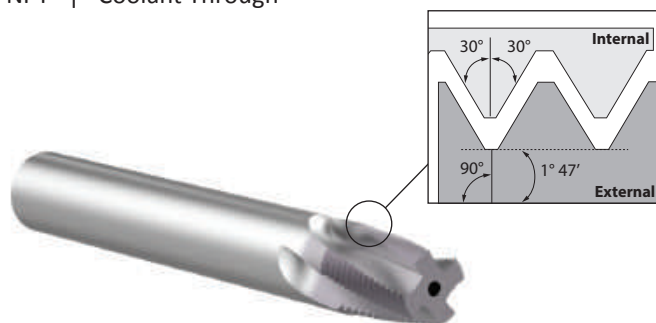

NPT | Coolant Through

	TPI (Pitch)	Min Thread Ø	Flutes	Thread Mill				Part No.
				D <sub>1</sub>	D <sub>2</sub>	L <sub>6</sub>	L <sub>1</sub>	ThreadMills USA
i	27	1/16 and 1/8	3	0.245	0.250	0.437	2.375	TM27NPTCH
	27	1/8	4	0.300	0.312	0.482	3.000	HDTM27NPTCH
	18	1/4 and 3/8	4	0.305	0.312	0.625	3.000	TM18NPTCH
	18	1/4 and 3/8	4	0.363	0.375	0.680	3.000	HDTM18NPTCH
	14	1/2 and 3/4	4	0.495	0.500	0.875	3.500	TM14NPTCH
	14	3/4	4	0.620	0.625	1.000	4.000	HDTM14NPTCH
	11.5	1	4	0.620	0.625	1.125	4.000	TM11NPTCH
	11	1	5	0.745	0.750	1.219	4.000	HDTM11NPTCH
	8	2-1/2	4	0.745	0.750	1.500	5.000	TM8NPTCH
m	27	1/16 and 1/8	3	5.95	6.00	11.30	58.00	TM27NPTCHM
	27	1/8	4	7.62	8.00	12.25	64.00	HDTM27NPTCHM
	18	1/4 and 3/8	4	7.75	8.00	15.70	64.00	TM18NPTCHM
	18	1/4 and 3/8	4	9.22	10.00	17.25	84.00	HDTM18NPTCHM
	14	1/2 and 3/4	4	11.95	12.00	23.70	84.00	TM14NPTCHM
	14	3/4	4	15.75	16.00	25.40	93.00	HDTM14NPTCHM
	11.5	1	4	15.75	16.00	28.75	93.00	TM11NPTCHM
	11.5	1	5	18.92	20.00	30.95	105.00	HDTM11NPTCHM
	8	2-1/2	5	19.75	20.00	38.10	115.00	TM8NPTCHM

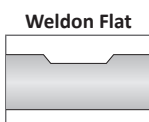
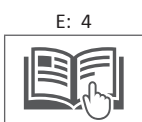
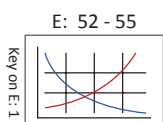

To order a thread mill with a Weldon flat, replace the leading TM designator with TW (available for inch shanks 3/8 and above, or metric shanks 6mm and above)  
**Example:** Cylindrical shank = **TM**NK0500-NPT | Weldon shank flat = **TW**NK0500-NPT  
**NOTE:** Weldon flats have a minimum order quantity of 2 pieces

i = Imperial (in)  
 m = Metric (mm)

## Solid Carbide Thread Mills

NPTF | Non-Coolant

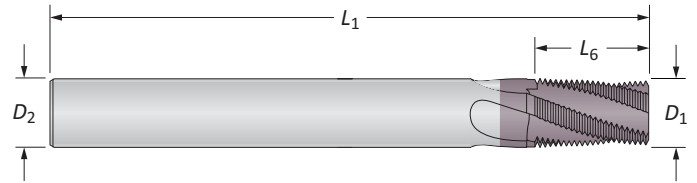
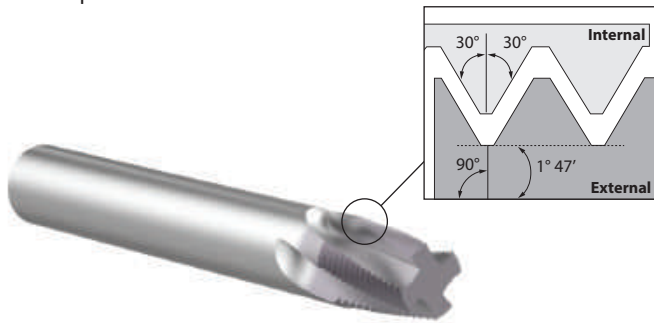

NPTF | Non-Coolant

	TPI (Pitch)	Min Thread $\phi$	Flutes	Thread Mill				Part No.	
				$D_1$	$D_2$	$L_6$	$L_1$	ThreadMills USA	AccuThread™ 856
i	27	1/16 and 1/8	3	0.245	0.250	0.437	2.500	TM27NPTF	TMNK0063-NPTF
	18	1/4 and 3/8	4	0.305	0.312	0.625	3.000	TM18NPTF	TMNK0250-NPTF
	14	1/2 and 3/4	4	0.495	0.500	0.875	3.500	TM14NPTF	TMNK0500-NPTF
	11.5	1	4	0.620	0.625	1.125	4.000	TM11NPTF	TMNK1000-NPTF
	8	2-1/2	4	0.745	0.750	1.500	5.000	TM8NPTF	TMNK2500-NPTF
m	27	1/16 and 1/8	3	5.95	6.00	11.30	58.00	TM27NPTFM	TMNK0063-NPTFM
	18	1/4 and 3/8	4	7.75	8.00	15.70	64.00	TM18NPTFM	TMNK0250-NPTFM
	14	1/2 and 3/4	4	11.95	12.00	23.70	84.00	TM14NPTFM	TMNK0500-NPTFM
	11.5	1	4	15.75	16.00	28.75	93.00	TM11NPTFM	TMNK1000-NPTFM
	8	2-1/2	5	19.75	20.00	38.10	115.00	TM8NPTFM	TMNK2500-NPTFM

D BURNISHING

F THREADING

X SPECIALS

E: 52 - 55

E: 4

Weldon Flat

To order a thread mill with a Weldon flat, replace the leading TM designator with TW (available for inch shanks 3/8 and above, or metric shanks 6mm and above)  
**Example:** Cylindrical shank = **TMNK0500-NPT** | Weldon shank flat = **TWKNK0500-NPT**  
**NOTE:** Weldon flats have a minimum order quantity of 2 pieces

i = Imperial (in)  
 m = Metric (mm)



### Solid Carbide Thread Mills

NPTF | Coolant Through

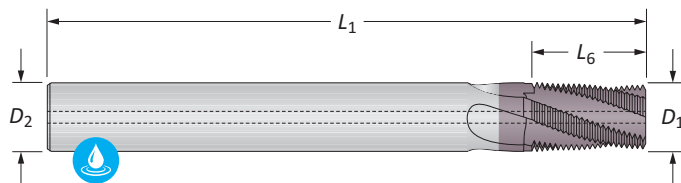
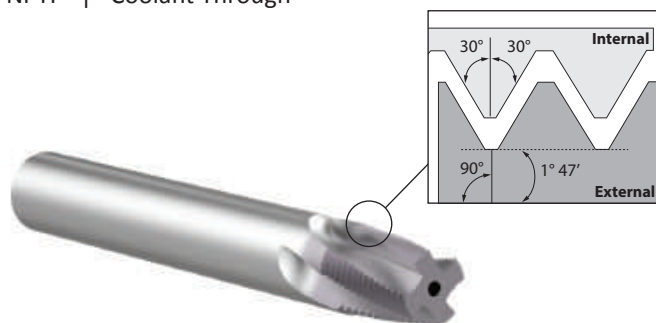

NPTF | Coolant Through

	TPI (Pitch)	Min Thread Ø	Flutes	Thread Mill				Part No.
				D <sub>1</sub>	D <sub>2</sub>	L <sub>6</sub>	L <sub>1</sub>	ThreadMills USA
i	27	1/16 and 1/8	3	0.245	0.250	0.437	2.375	<b>TM27NPTFCH</b>
	18	1/4 and 3/8	4	0.305	0.312	0.625	3.000	<b>TM18NPTFCH</b>
	14	1/2 and 3/4	4	0.495	0.500	0.875	3.500	<b>TM14NPTFCH</b>
	11.5	1	4	0.620	0.625	1.125	4.000	<b>TM11NPTFCH</b>
	8	2-1/2	4	0.745	0.750	1.500	5.000	<b>TM8NPTFCH</b>
m	27	1/16 and 1/8	3	5.95	6.00	11.30	58.00	<b>TM27NPTFCHM</b>
	18	1/4 and 3/8	4	7.75	8.00	15.70	64.00	<b>TM18NPTFCHM</b>
	14	1/2 and 3/4	4	11.95	12.00	23.70	84.00	<b>TM14NPTFCHM</b>
	11.5	1	4	15.75	16.00	28.75	93.00	<b>TM11NPTFCHM</b>
	8	2-1/2	5	19.75	20.00	38.10	115.00	<b>TM8NPTFCHM</b>

A

DRILLING

B

BORING

C

REAMING

D

BURNISHING

E

THREADING

X

SPECIALS

E: 52 - 55

E: 4

Weldon Flat

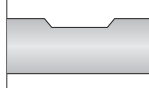
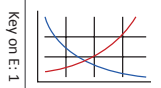

To order a thread mill with a Weldon flat, replace the leading TM designator with TW (available for inch shanks 3/8 and above, or metric shanks 6mm and above)  
**Example:** Cylindrical shank = **TM**NK0500-NPT | Weldon shank flat = **TW**NK0500-NPT  
**NOTE:** Weldon flats have a minimum order quantity of 2 pieces

i = Imperial (in)  
 m = Metric (mm)

### Solid Carbide Thread Mills

#### NPS

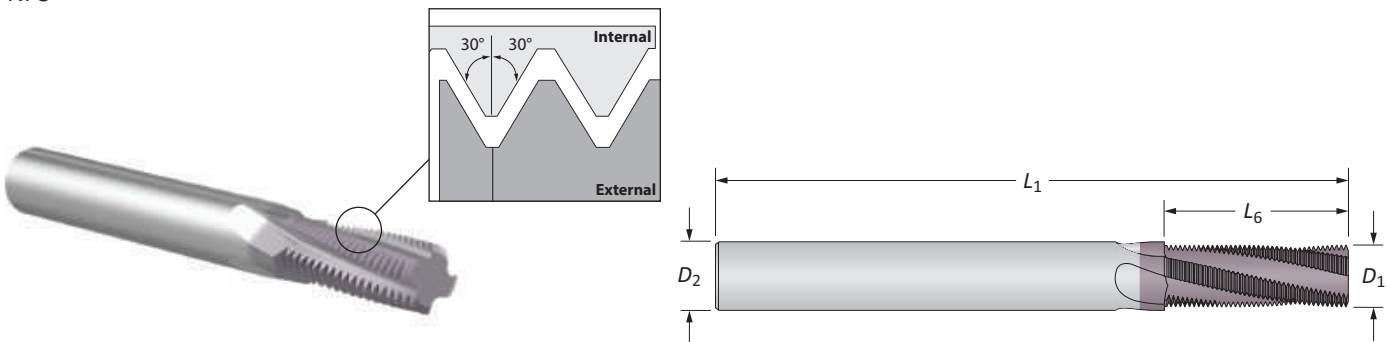

#### NPS | Non-Coolant

TPI (Pitch)	Min Thread Ø	Flutes	Thread Mill				Part No.
			D <sub>1</sub>	D <sub>2</sub>	L <sub>6</sub>	L <sub>1</sub>	
27	1/8	3	0.245	0.250	0.630	2.500	<b>TM27NPS</b>
18	1/4 and 3/8	4	0.370	0.375	0.889	3.500	<b>TM18NPS</b>
14	1/2 and 3/4	4	0.490	0.500	1.288	3.500	<b>TM14NPS</b>
11.5	1	4	0.620	0.625	1.392	4.000	<b>TM11NPS</b>
27	1/8	3	5.95	6.00	16.00	58.00	<b>TM27NPSM</b>
18	1/4 and 3/8	4	9.40	10.00	22.60	84.00	<b>TM18NPSM</b>
14	1/2 and 3/4	4	11.94	12.00	32.70	84.00	<b>TM14NPSM</b>
11.5	1	4	15.75	16.00	35.35	93.00	<b>TM11NPSM</b>

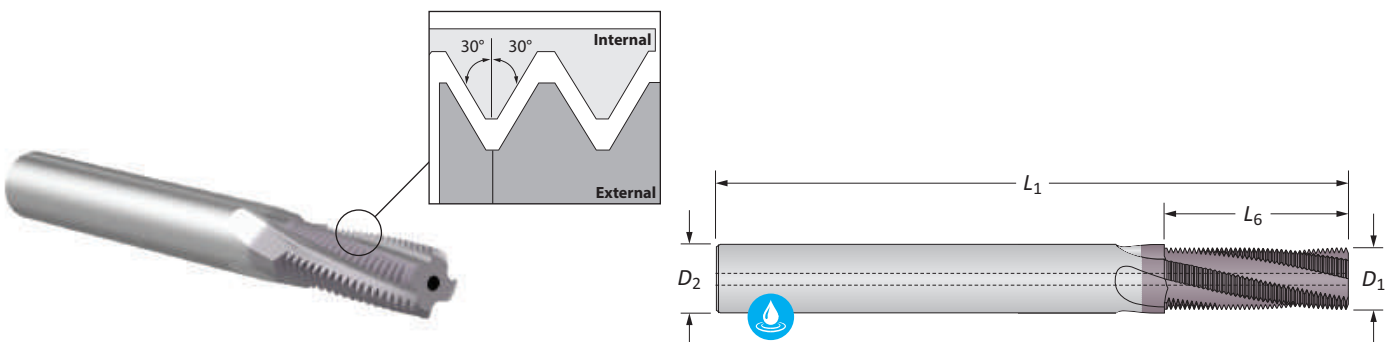

#### NPS | Coolant Through

TPI (Pitch)	Min Thread Ø	Flutes	Thread Mill				Part No.
			D <sub>1</sub>	D <sub>2</sub>	L <sub>6</sub>	L <sub>1</sub>	
27	1/8	3	0.245	0.250	0.630	2.375	<b>TM27NPSCH</b>
18	1/4 and 3/8	4	0.370	0.375	0.889	3.000	<b>TM18NPSCH</b>
14	1/2 and 3/4	4	0.490	0.500	1.288	3.500	<b>TM14NPSCH</b>
11.5	1	4	0.620	0.625	1.392	4.000	<b>TM11NPSCH</b>
27	1/8	3	5.95	6.00	16.00	58.00	<b>TM27NPSCHM</b>
18	1/4 and 3/8	4	9.40	10.00	22.60	84.00	<b>TM18NPSCHM</b>
14	1/2 and 3/4	4	11.94	12.00	32.70	84.00	<b>TM14NPSCHM</b>
11.5	1	4	15.75	16.00	35.35	93.00	<b>TM11NPSCHM</b>

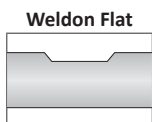
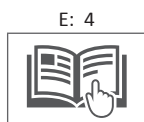
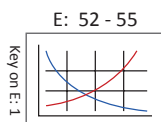

To order a thread mill with a Weldon flat, replace the leading TM designator with TW (available for inch shanks 3/8 and above, or metric shanks 6mm and above)  
**Example:** Cylindrical shank = **TW**NK0500-NPT | Weldon shank flat = **TWN**K0500-NPT  
**NOTE:** Weldon flats have a minimum order quantity of 2 pieces

**i** = Imperial (in)  
**m** = Metric (mm)





### Solid Carbide Thread Mills

NPSF

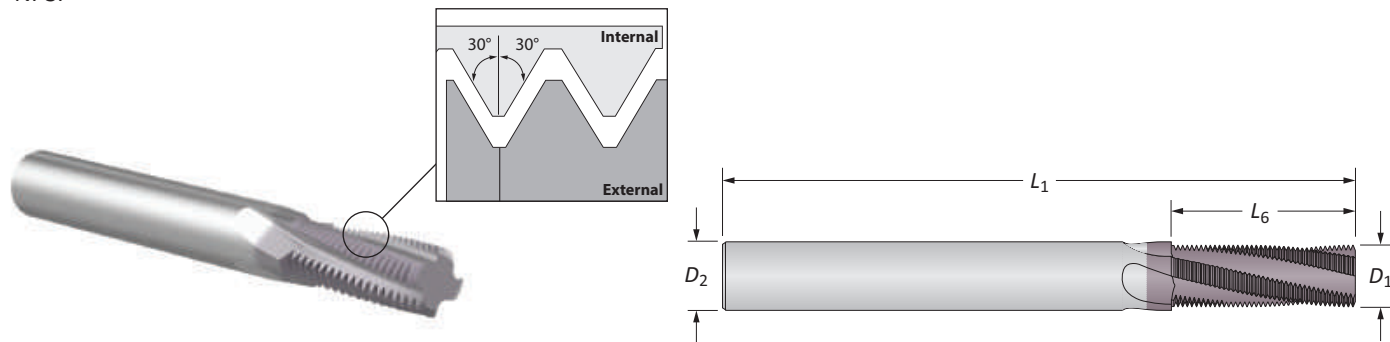

NPSF | Non-Coolant

	TPI (Pitch)	Min Thread Ø	Flutes	Thread Mill				Part No.
				D <sub>1</sub>	D <sub>2</sub>	L <sub>6</sub>	L <sub>1</sub>	ThreadMills USA
i	27	1/8	3	0.245	0.250	0.630	2.500	TM27NPSF
	18	1/4 and 3/8	4	0.370	0.375	0.889	3.500	TM18NPSF
	14	1/2 and 3/4	4	0.490	0.500	1.288	3.500	TM14NPSF
	11.5	1	4	0.620	0.625	1.392	4.000	TM11NPSF
m	27	1/8	3	5.95	6.00	16.00	58.00	TM27NPSFM
	18	1/4 and 3/8	4	9.40	10.00	22.60	84.00	TM18NPSFM
	14	1/2 and 3/4	4	11.94	12.00	32.70	84.00	TM14NPSFM
	11.5	1	4	15.75	16.00	35.35	93.00	TM11NPSFM

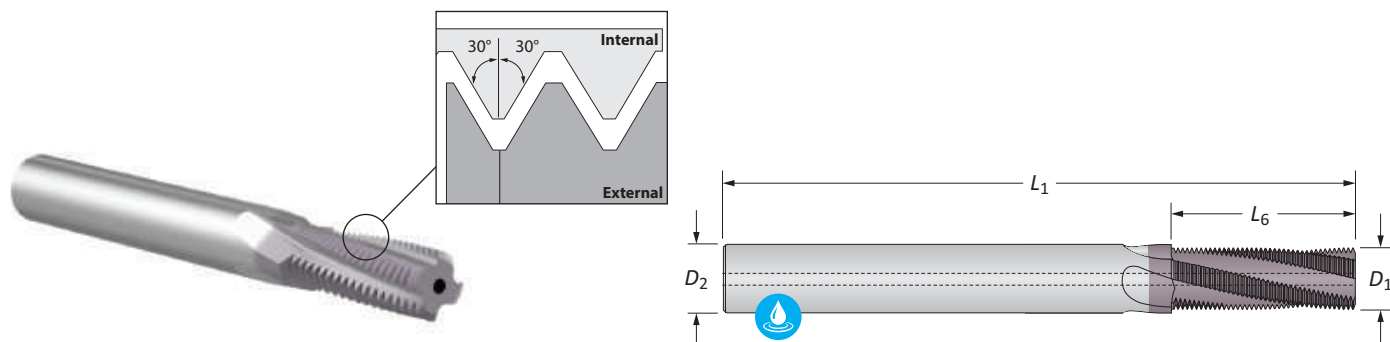

NPSF | Coolant Through

	TPI (Pitch)	Min Thread Ø	Flutes	Thread Mill				Part No.
				D <sub>1</sub>	D <sub>2</sub>	L <sub>6</sub>	L <sub>1</sub>	ThreadMills USA
i	27	1/8	3	0.245	0.250	0.630	2.375	TM27NPSFCH
	18	1/4 and 3/8	4	0.370	0.375	0.889	3.000	TM18NPSFCH
	14	1/2 and 3/4	4	0.490	0.500	1.288	3.500	TM14NPSFCH
	11.5	1	4	0.620	0.625	1.392	4.000	TM11NPSFCH
m	27	1/8	3	5.95	6.00	16.00	58.00	TM27NPSFCHM
	18	1/4 and 3/8	4	9.40	10.00	22.60	84.00	TM18NPSFCHM
	14	1/2 and 3/4	4	11.94	12.00	32.70	84.00	TM14NPSFCHM
	11.5	1	4	15.75	16.00	35.35	93.00	TM11NPSFCHM

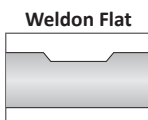
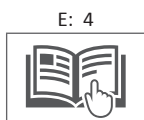
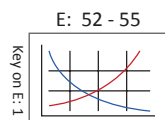

To order a thread mill with a Weldon flat, replace the leading TM designator with TW (available for inch shanks 3/8 and above, or metric shanks 6mm and above)  
**Example:** Cylindrical shank = **TM**NK0500-NPT | Weldon shank flat = **TW**NK0500-NPT  
**NOTE:** Weldon flats have a minimum order quantity of 2 pieces

i = Imperial (in)  
 m = Metric (mm)

## Solid Carbide Thread Mills

UN | Non-Coolant

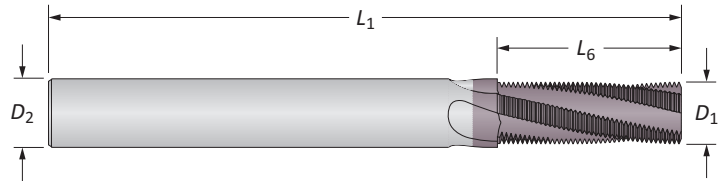
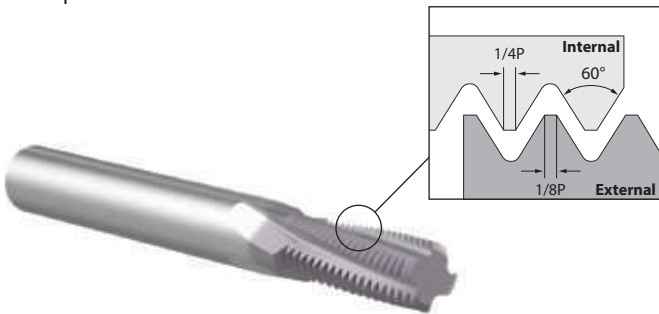

UN | Non-Coolant

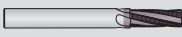
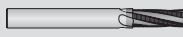
TPI (Pitch)	Min Thread Ø	Flutes	Thread Mill				Part No.	
			$D_1$	$D_2$	$L_6$	$L_1$	 ThreadMills USA	 AccuThread™ 856
64	#2	3*	0.065	0.125	0.125	2.000	TM08664	–
56	#2	3*	0.065	0.125	0.125	2.000	TM08656	TMUK0002-56
48	#3	3*	0.075	0.125	0.167	2.000	TM09948	–
44	#5	3	0.095	0.125	0.228	2.000	TM12544	–
40	#4	3*	0.085	0.125	0.175	2.000	TM12540	TMUK0004-40
36	#8	3	0.115	0.125	0.250	2.000	TM16436	–
32	#6	3	0.100	0.125	0.218	2.000	TM13832	TMUK0006-32
32	#8	3	0.115	0.125	0.250	2.000	TM16432	TMUK0008-32
32	#10	3	0.120	0.125	0.312	2.000	TM19032	TMUK0010-32
32	#10	3	0.150	0.187	0.312	2.500	HDTM19032	–
32	1/2	6	0.370	0.375	1.000	3.500	TM50032	–
<b>i</b> 28	#10	3	0.120	0.125	0.312	2.000	TM19028	TMUK0010-28
28	1/4	3	0.180	0.187	0.500	2.500	TM25028	TMUK0250-28
28	1/2	6	0.370	0.375	1.000	3.500	TM50028	–
24	#10	3	0.120	0.125	0.312	2.000	TM19024	TMUK0010-24
24	#10	3	0.145	0.187	0.312	2.500	HDTM19024	–
24	5/16	3	0.235	0.250	0.625	2.500	TM31224	TMUK0313-24
24	3/8	4	0.285	0.312	0.750	3.000	TM37524	TMUK0375-24
24	1/2	6	0.370	0.375	1.000	3.500	TM50024	–
20	1/4	3	0.180	0.187	0.500	2.500	TM25020	TMUK0250-20
20	1/4	3	0.195	0.250	0.500	2.500	HDTM25020	–
20	7/16	4	0.335	0.375	0.875	3.500	TM43720	TMUK0438-20
20	1/2	6	0.370	0.375	1.000	3.500	TM50020	–

\*Straight fluted

E: 52 - 55

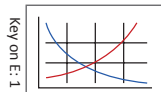

E: 4



Weldon Flat

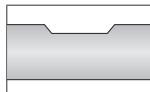

To order a thread mill with a Weldon flat, replace the leading TM designator with TW (available for inch shanks 3/8 and above, or metric shanks 6mm and above)

**Example:** Cylindrical shank = **TM**NK0500-NPT | Weldon shank flat = **TWN**K0500-NPT

**NOTE:** Weldon flats have a minimum order quantity of 2 pieces

**i** = Imperial (in)  
**m** = Metric (mm)



### Solid Carbide Thread Mills

UN | Non-Coolant (continued)

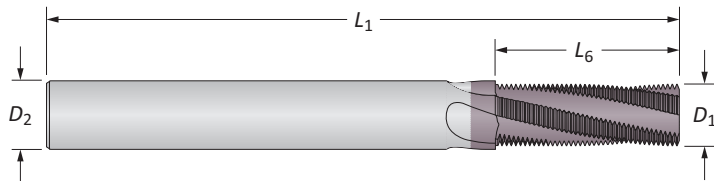
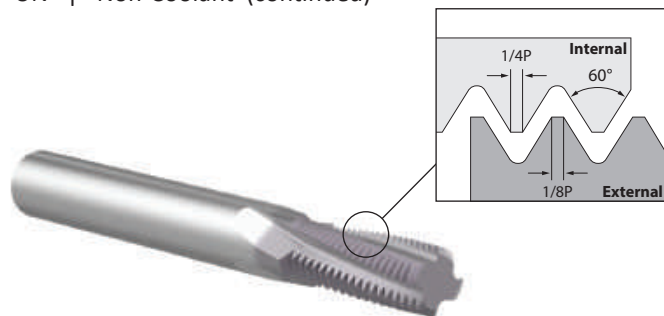

UN | Non-Coolant

TPI (Pitch)	Min Thread Ø	Flutes	Thread Mill				Part No.	
			D <sub>1</sub>	D <sub>2</sub>	L <sub>6</sub>	L <sub>1</sub>	ThreadMills USA	AccuThread™ 856
18	5/16	3	0.235	0.250	0.625	2.500	TM31218	TMUK0313-18
18	5/16	3	0.245	0.312	0.625	3.000	HDTM31218	-
18	9/16	4	0.370	0.375	0.875	3.500	TM56218	TMUK0563-18
16	3/8	4	0.285	0.312	0.750	3.000	TM37516	TMUK0375-16
16	3/8	4	0.300	0.375	0.750	3.500	HDTM37516	-
16	3/4	4	0.490	0.500	1.250	3.500	TM75016	TMUK0750-16
14	7/16	4	0.305	0.312	0.750	3.000	TM43714	TMUK0438-14
14	7/8	4	0.490	0.500	1.250	3.500	TM87514	TMUK0875-14
13	1/2	4	0.350	0.375	0.875	3.500	TM50013	TMUK0500-13
13	1/2	4	0.400	0.500	0.875	3.500	HDTM50013	-
12	9/16	4	0.370	0.375	0.875	3.500	TM56212	TMUK0563-12
i	12	3/4	0.495	0.500	1.250	3.500	TM75012	TMUK0750-12
12	1	6	0.745	0.750	1.500	4.000	TM10012	-
11	5/8	4	0.470	0.500	1.250	3.500	TM62511	TMUK0625-11
11	5/8	4	0.470	0.500	1.455	3.500	TM62511-XL	TMUK0625-11XL
10	3/4	4	0.495	0.500	1.250	3.500	TM75010	TMUK0750-10
10	3/4	4	0.495	0.500	1.600	4.000	TM75010-XL	TMUK0750-10XL
9	7/8	4	0.620	0.625	1.375	4.000	TM87509	TMUK0875-9
9	7/8	4	0.620	0.625	1.778	4.000	TM87509-XL	TMUK0875-9XL
8	1	4	0.620	0.625	1.375	4.000	TM10008	TMUK1000-8
8	1	6	0.745	0.750	2.000	4.500	TM10008-XL	TMUK1000-8XL
7	1-1/8	5	0.745	0.750	1.572	4.500	TM12507	-
6	1-3/8	5	0.745	0.750	1.500	4.500	TM13706	-

E: 52 - 55

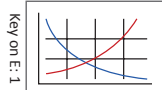

E: 4



Weldon Flat

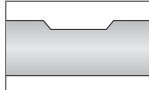

To order a thread mill with a Weldon flat, replace the leading TM designator with TW (available for inch shanks 3/8 and above, or metric shanks 6mm and above)  
**Example:** Cylindrical shank = **TM**NK0500-NPT | Weldon shank flat = **TW**NK0500-NPT  
**NOTE:** Weldon flats have a minimum order quantity of 2 pieces

i = Imperial (in)  
 m = Metric (mm)



## Solid Carbide Thread Mills

UN | Non-Coolant

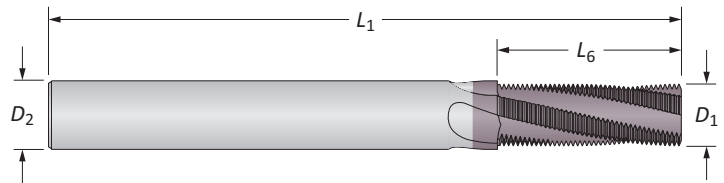
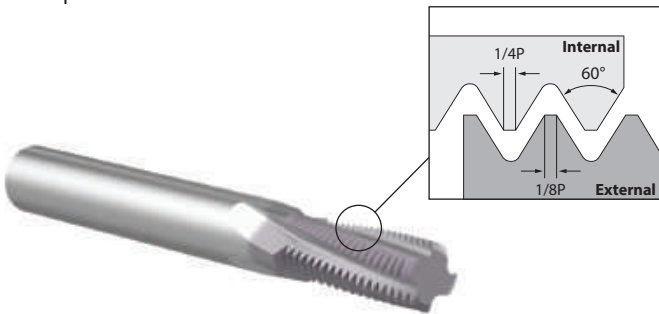

UN | Non-Coolant

TPI (Pitch)	Min Thread Ø	Flutes	Thread Mill				Part No.	
			$D_1$	$D_2$	$L_6$	$L_1$	ThreadMills USA	AccuThread™ 856
64	#2	3*	1.65	3.00	3.20	39.00	TM08664M	TMUK0002-64M
56	#2	3*	1.65	3.00	3.20	39.00	TM08656M	TMUK0002-56M
48	#3	3*	1.80	3.00	3.75	39.00	TM09948M	TMUK0003-48M
44	#5	3	2.40	3.00	4.65	39.00	TM12544M	TMUK0005-44M
40	#4	3*	2.20	3.00	4.45	39.00	TM12540M	TMUK0004-40M
36	#8	3	3.00	4.00	6.35	51.00	TM16436M	TMUK0008-36M
32	#6	3	2.50	3.00	5.55	39.00	TM13832M	TMUK0006-32M
32	#8	3	3.20	4.00	6.35	51.00	TM16432M	TMUK0008-32M
32	#10	3	3.80	4.00	7.95	51.00	TM19032M	TMUK0010-32M
32	#10	3	3.80	4.00	7.95	51.00	HDTM19032M	-
32	1/2	6	9.40	10.00	25.40	84.00	TM50032M	-
28	#10	3	3.80	4.00	8.20	51.00	TM19028M	TMUK0010-28M
28	1/4	3	4.75	6.00	12.70	58.00	TM25028M	TMUK0250-28M
28	7/16	4	7.90	8.00	19.95	64.00	-	TMUK0438-28M
28	1/2	6	9.40	10.00	25.40	84.00	TM50028M	-
24	#10	3	3.70	4.00	8.50	51.00	TM19024M	TMUK0010-24M
24	#10	3	3.70	4.00	8.50	51.00	HDTM19024M	TMUK0313-24M
24	5/16	3	5.95	6.00	16.00	58.00	TM31224M	TMUK0375-24M
24	3/8	4	7.25	8.00	19.00	64.00	TM37524M	-
24	1/2	6	9.40	10.00	25.40	84.00	TM50024M	-
20	1/4	3	4.75	6.00	12.70	58.00	TM25020M	TMUK0250-20M
20	1/4	3	4.95	6.00	12.70	58.00	HDTM25020M	-
20	7/16	4	8.75	10.00	22.85	73.00	TM43720M	TMUK0438-20M
20	1/2	6	9.40	10.00	25.40	84.00	TM50020M	-

\*Straight fluted

E: 52 - 55

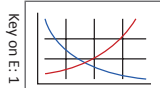

E: 4



Weldon Flat

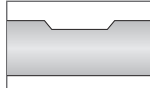

To order a thread mill with a Weldon flat, replace the leading TM designator with TW (available for inch shanks 3/8 and above, or metric shanks 6mm and above)

**Example:** Cylindrical shank = **TW**NK0500-NPT | Weldon shank flat = **TWN**K0500-NPT

**NOTE:** Weldon flats have a minimum order quantity of 2 pieces

ⓘ = Imperial (in)  
Ⓜ = Metric (mm)

### Solid Carbide Thread Mills

UN | Non-Coolant (continued)

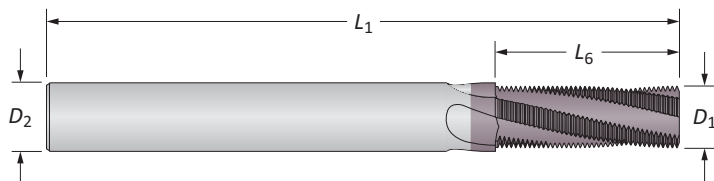
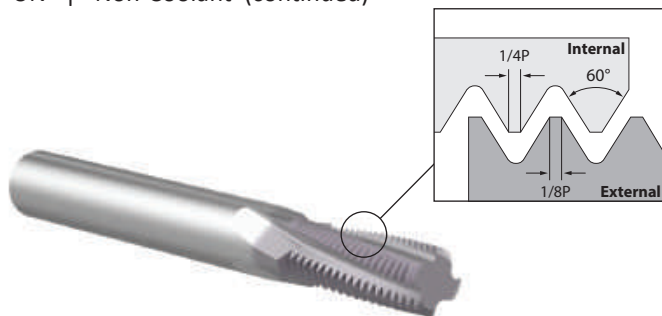

UN | Non-Coolant

TPI (Pitch)	Min Thread Ø	Flutes	Thread Mill				Part No.	
			D <sub>1</sub>	D <sub>2</sub>	L <sub>6</sub>	L <sub>1</sub>	ThreadMills USA	AccuThread™ 856
18	5/16	3	5.95	6.00	17.00	58.00	TM31218M	TMUK0313-18M
18	5/16	3	6.22	8.00	15.87	64.00	HDTM31218M	-
18	9/16	4	9.90	10.00	22.65	73.00	TM56218M	TMUK0563-18M
16	3/8	4	7.25	8.00	19.05	64.00	TM37516M	TMUK0375-16M
16	3/8	4	7.62	10.00	19.05	84.00	HDTM37516M	-
16	3/4	4	11.95	12.00	31.75	84.00	TM75016M	TMUK0750-16M
14	7/16	4	7.75	8.00	20.00	64.00	TM43714M	TMUK0438-14M
14	7/8	4	11.95	12.00	32.70	84.00	TM87514M	TMUK0875-14M
13	1/2	4	9.40	10.00	23.50	73.00	TM50013M	TMUK0500-13M
13	1/2	4	10.16	12.00	23.50	84.00	HDTM50013M	-
12	9/16	4	9.90	10.00	23.35	73.00	TM56212M	TMUK0563-12M
12	3/4	4	11.95	12.00	31.75	84.00	TM75012M	TMUK0750-12M
12	1	6	18.92	20.00	38.10	105.00	TM10012M	-
11	5/8	4	11.95	12.00	32.40	84.00	TM62511M	TMUK0625-11M
11	5/8	4	11.95	12.00	37.00	100.00	TM62511M-XL	TMUK0625-11XLM
10	3/4	4	11.95	12.00	33.00	84.00	TM75010M	TMUK0750-10M
10	3/4	4	11.95	12.00	40.70	100.00	TM75010M-XL	TMUK0750-10XLM
9	7/8	4	15.75	16.00	36.75	93.00	TM87509M	TMUK0875-9M
9	7/8	4	15.75	16.00	45.20	100.00	TM87509M-XL	TMUK0875-9XLM
8	1	4	15.75	16.00	35.00	93.00	TM10008M	TMUK1000-8M
8	1	6	19.90	20.00	50.80	115.00	TM10008M-XL	TMUK1000-8XLM
7	1-1/8	5	19.90	20.00	36.30	105.00	TM12507M	TMUK1125-7M
6	1-3/8	5	19.90	20.00	38.10	105.00	TM13706M	TMUK1375-6M

mm

E: 52 - 55

E: 4

Weldon Flat

To order a thread mill with a Weldon flat, replace the leading TM designator with TW (available for inch shanks 3/8 and above, or metric shanks 6mm and above)  
**Example:** Cylindrical shank = **TM**NK0500-NPT | Weldon shank flat = **TW**NK0500-NPT  
**NOTE:** Weldon flats have a minimum order quantity of 2 pieces

Ⓜ = Imperial (in)  
 Ⓜ = Metric (mm)

A

DRILLING

B

BORING

C

REAMING

D

BURNISHING

E

THREADING

X

SPECIALS

## Solid Carbide Thread Mills

UN | Coolant Through

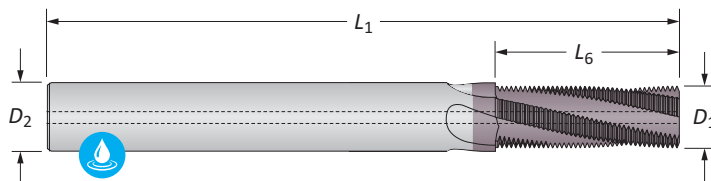
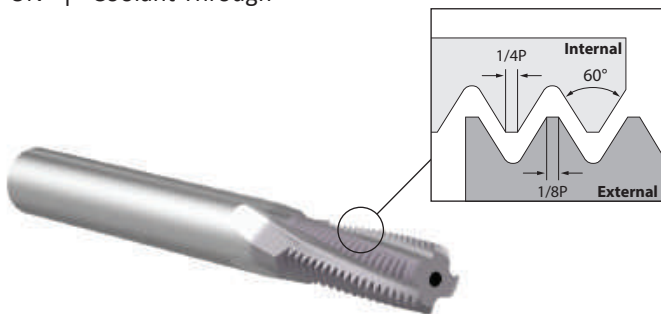

UN | Coolant Through

TPI (Pitch)	Min Thread Ø	Flutes	Thread Mill				Part No.
			$D_1$	$D_2$	$L_6$	$L_1$	
64	#2	3*	0.065	0.125	0.125	1.500	<b>TM08664CH</b>
56	#2	3*	0.065	0.125	0.125	1.500	<b>TM08656CH</b>
48	#3	3*	0.075	0.125	0.167	1.500	<b>TM09948CH</b>
44	#5	3	0.095	0.125	0.228	1.500	<b>TM12544CH</b>
40	#4	3*	0.085	0.125	0.175	1.500	<b>TM12540CH</b>
36	#8	3	0.115	0.125	0.250	1.500	<b>TM16436CH</b>
32	#6	3	0.100	0.125	0.218	1.500	<b>TM13832CH</b>
32	#8	3	0.115	0.125	0.250	1.500	<b>TM16432CH</b>
32	#10	3	0.150	0.187	0.312	2.375	<b>TM19032CH</b>
32	#10	3	0.150	0.187	0.312	2.375	<b>HDTM19032CH</b>
32	1/2	6	0.370	0.375	1.000	3.500	<b>TM50032CH</b>
<b>i</b> 28	#10	3	0.120	0.125	0.312	1.500	<b>TM19028CH</b>
28	1/4	3	0.180	0.187	0.500	2.375	<b>TM25028CH</b>
28	1/2	6	0.370	0.375	1.000	3.500	<b>TM50028CH</b>
24	#10	3	0.145	0.187	0.312	2.375	<b>TM19024CH</b>
24	#10	3	0.145	0.187	0.312	2.375	<b>HDTM19024CH</b>
24	5/16	3	0.235	0.250	0.625	2.375	<b>TM31224CH</b>
24	3/8	4	0.285	0.312	0.750	3.000	<b>TM37524CH</b>
24	1/2	6	0.370	0.375	1.000	3.500	<b>TM50024CH</b>
20	1/4	3	0.180	0.187	0.500	2.375	<b>TM25020CH</b>
20	1/4	3	0.195	0.250	0.500	2.375	<b>HDTM25020CH</b>
20	7/16	4	0.335	0.375	0.875	3.000	<b>TM43720CH</b>
20	1/2	6	0.370	0.375	1.000	3.500	<b>TM50020CH</b>

\*Straight fluted

E: 52 - 55

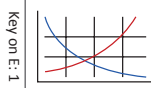

Key on E: 1

E: 4



Weldon Flat

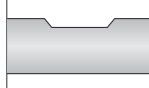

To order a thread mill with a Weldon flat, replace the leading TM designator with TW (available for inch shanks 3/8 and above, or metric shanks 6mm and above)

**Example:** Cylindrical shank = **TM**NK0500-NPT | Weldon shank flat = **TW**NK0500-NPT

**NOTE:** Weldon flats have a minimum order quantity of 2 pieces

**i** = Imperial (in)  
**m** = Metric (mm)



### Solid Carbide Thread Mills

#### UN | Coolant Through (continued)

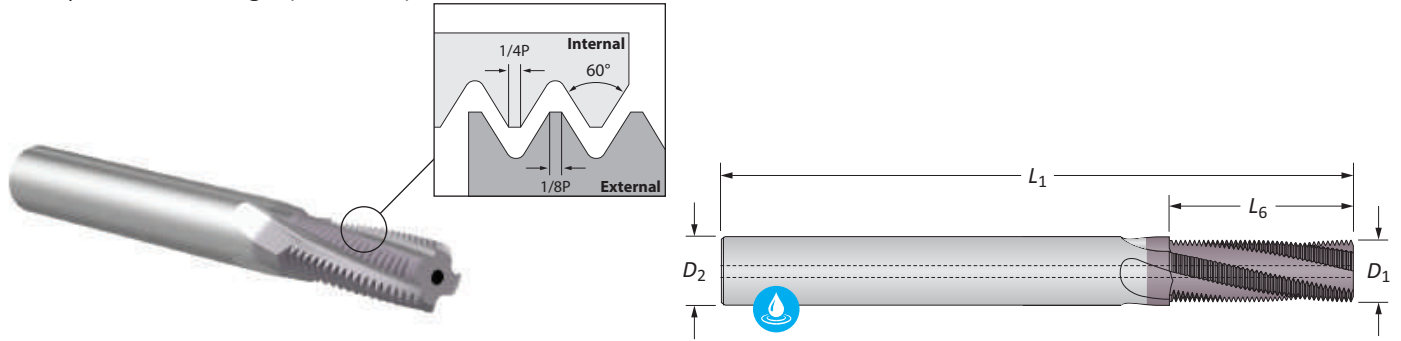

#### UN | Coolant Through

TPI (Pitch)	Min Thread $\phi$	Flutes	Thread Mill				Part No.
			$D_1$	$D_2$	$L_6$	$L_1$	
18	5/16	3	0.235	0.250	0.625	2.375	TM31218CH
18	5/16	3	0.245	0.312	0.625	3.000	HDTM31218CH
18	9/16	4	0.370	0.375	0.875	3.000	TM56218CH
16	3/8	4	0.285	0.312	0.750	3.000	TM37516CH
16	3/8	4	0.300	0.375	0.750	3.000	HDTM37516CH
16	3/4	4	0.490	0.500	1.250	3.500	TM75016CH
14	7/16	4	0.305	0.312	0.750	3.000	TM43714CH
14	7/8	4	0.490	0.500	1.250	3.500	TM87514CH
13	1/2	4	0.350	0.375	0.875	3.000	TM50013CH
13	1/2	4	0.400	0.500	0.875	3.500	HDTM50013CH
12	9/16	4	0.370	0.375	0.875	3.500	TM56212CH
12	3/4	4	0.495	0.500	1.250	3.500	TM75012CH
12	1	6	0.745	0.750	1.500	4.000	TM10012CH
11	5/8	4	0.470	0.500	1.250	3.500	TM62511CH
11	5/8	4	0.470	0.500	1.455	3.500	TM62511CH-XL
10	3/4	4	0.495	0.500	1.250	3.500	TM75010CH
10	3/4	4	0.495	0.500	1.600	4.000	TM75010CH-XL
9	7/8	4	0.620	0.625	1.375	4.000	TM87509CH
9	7/8	4	0.620	0.625	1.778	4.000	TM87509CH-XL
8	1	4	0.620	0.625	1.375	4.000	TM10008CH
8	1	6	0.745	0.750	2.000	4.500	TM10008CH-XL
7	1-1/8	5	0.745	0.750	1.572	4.500	TM12507CH
6	1-3/8	5	0.745	0.750	1.500	4.500	TM13706CH

i

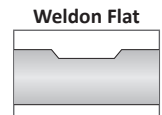
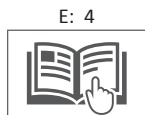
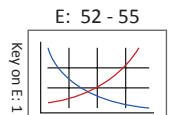

To order a thread mill with a Weldon flat, replace the leading TM designator with TW (available for inch shanks 3/8 and above, or metric shanks 6mm and above)  
**Example:** Cylindrical shank = **TM**NK0500-NPT | Weldon shank flat = **TW**NK0500-NPT  
**NOTE:** Weldon flats have a minimum order quantity of 2 pieces

i = Imperial (in)  
 m = Metric (mm)

A DRILLING  
 B BORING  
 C REAMING  
 D BURNISHING  
 E THREADING  
 X SPECIALS

## Solid Carbide Thread Mills

UN | Coolant Through

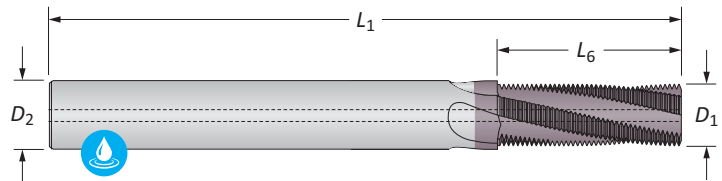
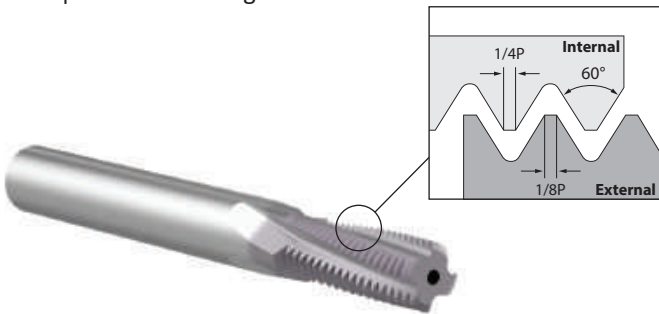

UN | Coolant Through

TPI (Pitch)	Min Thread Ø	Flutes	Thread Mill				Part No.
			$D_1$	$D_2$	$L_6$	$L_1$	
64	#2	3*	1.65	3.00	3.20	39.00	<b>TM08664CHM</b>
56	#2	3*	1.65	3.00	3.20	39.00	<b>TM08656CHM</b>
48	#3	3*	1.80	3.00	3.75	39.00	<b>TM09948CHM</b>
44	#5	3	2.40	3.00	4.65	39.00	<b>TM12544CHM</b>
40	#4	3*	2.20	3.00	4.45	39.00	<b>TM12540CHM</b>
36	#8	3	3.00	4.00	6.35	51.00	<b>TM16436CHM</b>
32	#6	3	2.50	3.00	5.55	39.00	<b>TM13832CHM</b>
32	#8	3	3.20	4.00	6.35	51.00	<b>TM16432CHM</b>
32	#10	3	3.80	4.00	7.95	51.00	<b>TM19032CHM</b>
32	#10	3	3.80	4.00	7.95	51.00	<b>HDTM19032CHM</b>
32	1/2	6	9.40	10.00	25.40	84.00	<b>TM50032CHM</b>
<b>m</b> 28	#10	3	3.80	4.00	8.20	51.00	<b>TM19028CHM</b>
28	1/4	3	4.75	6.00	12.70	58.00	<b>TM25028CHM</b>
28	1/2	6	9.40	10.00	25.40	84.00	<b>TM50028CHM</b>
24	#10	3	3.68	4.00	8.50	51.00	<b>TM19024CHM</b>
24	#10	3	3.70	4.00	8.50	51.00	<b>HDTM19024CHM</b>
24	5/16	3	5.95	6.00	16.00	58.00	<b>TM31224CHM</b>
24	3/8	4	7.25	8.00	19.00	64.00	<b>TM37524CHM</b>
24	1/2	6	9.40	10.00	25.40	84.00	<b>TM50024CHM</b>
20	1/4	3	4.75	6.00	12.70	58.00	<b>TM25020CHM</b>
20	1/4	3	4.95	6.00	12.70	58.00	<b>HDTM25020CHM</b>
20	7/16	4	8.75	10.00	22.85	84.00	<b>TM43720CHM</b>
20	1/2	6	9.40	10.00	25.40	84.00	<b>TM50020CHM</b>

\*Straight fluted

E: 52 - 55

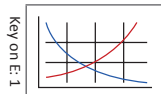

E: 4



Weldon Flat

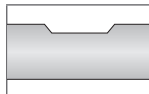

To order a thread mill with a Weldon flat, replace the leading TM designator with TW (available for inch shanks 3/8 and above, or metric shanks 6mm and above)

**Example:** Cylindrical shank = **TM**NK0500-NPT | Weldon shank flat = **TW**NK0500-NPT

**NOTE:** Weldon flats have a minimum order quantity of 2 pieces

**i** = Imperial (in)  
**m** = Metric (mm)





### Solid Carbide Thread Mills

UN | Coolant Through (continued)

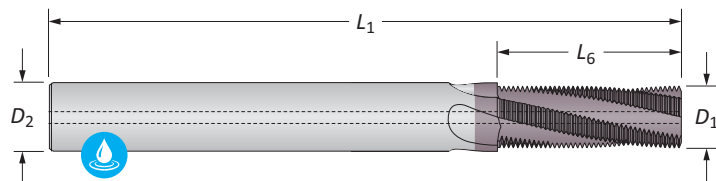
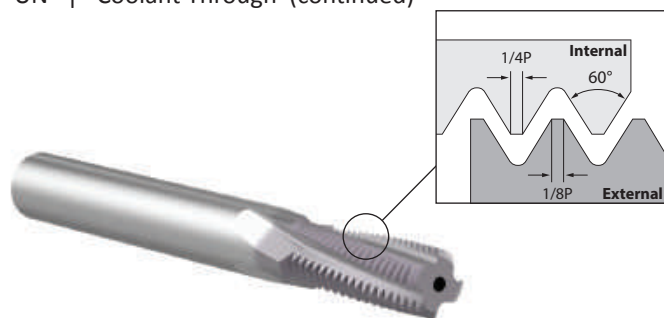

UN | Coolant Through

TPI (Pitch)	Min Thread $\phi$	Flutes	Thread Mill				Part No.
			$D_1$	$D_2$	$L_6$	$L_1$	
18	5/16	3	5.95	6.00	17.00	58.00	TM31218CHM
18	5/16	3	6.22	8.00	15.87	64.00	HDTM31218CHM
18	9/16	4	9.90	10.00	22.65	84.00	TM56218CHM
16	3/8	4	7.25	8.00	19.05	64.00	TM37516CHM
16	3/8	4	7.62	10.00	19.05	84.00	HDTM37516CHM
16	3/4	4	11.95	12.00	31.75	84.00	TM75016CHM
14	7/16	4	7.75	8.00	20.00	64.00	TM43714CHM
14	7/8	4	11.95	12.00	32.70	84.00	TM87514CHM
13	1/2	4	9.40	10.00	23.50	84.00	TM50013CHM
13	1/2	4	10.16	12.00	23.50	84.00	HDTM50013CHM
12	9/16	4	9.90	10.00	23.35	84.00	TM56212CHM
12	3/4	4	11.95	12.00	31.75	84.00	TM75012CHM
12	1	6	18.92	20.00	38.10	105.00	TM10012CHM
11	5/8	4	11.95	12.00	32.40	84.00	TM62511CHM
11	5/8	4	11.95	12.00	37.00	100.00	TM62511CHM-XL
10	3/4	4	11.95	12.00	33.00	84.00	TM75010CHM
10	3/4	4	11.95	12.00	40.70	100.00	TM75010CHM-XL
9	7/8	4	15.75	16.00	36.75	93.00	TM87509CHM
9	7/8	4	15.75	16.00	45.20	100.00	TM87509CHM-XL
8	1	4	15.75	16.00	35.00	93.00	TM10008CHM
8	1	6	19.90	20.00	50.80	115.00	TM10008CHM-XL
7	1-1/8	5	19.90	20.00	36.10	105.00	TM12507CHM
6	1-3/8	5	19.90	20.00	38.10	105.00	TM13706CHM

Ⓜ

E: 52 - 55

E: 4

Weldon Flat

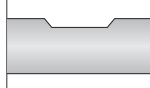
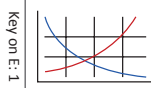

To order a thread mill with a Weldon flat, replace the leading TM designator with TW (available for inch shanks 3/8 and above, or metric shanks 6mm and above)  
**Example:** Cylindrical shank = **TM**NK0500-NPT | Weldon shank flat = **TW**NK0500-NPT  
**NOTE:** Weldon flats have a minimum order quantity of 2 pieces

Ⓜ = Imperial (in)  
 Ⓜ = Metric (mm)

## Solid Carbide Thread Mills

ISO | Non-Coolant

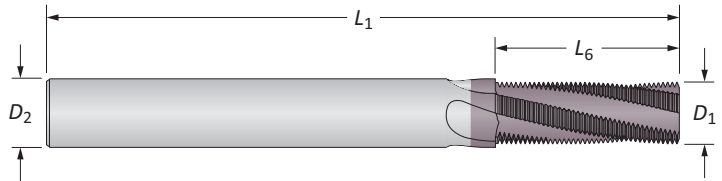
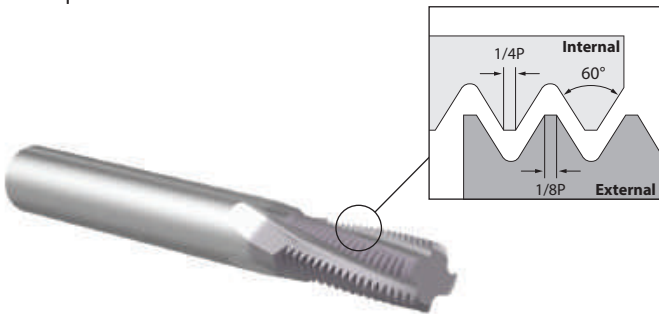

ISO | Non-Coolant

Pitch	Min Thread $\phi$	Flutes	Thread Mill				Part No.	
			$D_1$	$D_2$	$L_6$	$L_1$	ThreadMills USA	AccuThread™ 856
0.40	M2	3*	0.059	0.125	0.126	2.000	TM20040	–
0.45	M2.5	3*	0.059	0.125	0.142	2.000	TM25045	–
0.50	M3	3*	0.085	0.125	0.178	2.000	TM30050	–
0.50	M6	3	0.181	0.187	0.473	2.500	TM60050	–
0.50	M10	4	0.310	0.312	0.591	3.000	TM10050	–
0.70	M4	3	0.115	0.125	0.276	2.000	TM40070	–
0.75	M4.5	3	0.120	0.125	0.266	2.000	TM45075	TMMK0450-075
0.75	M8	3	0.235	0.250	0.625	2.500	TM80075	TMMK0800-075
0.75	M10	4	0.310	0.312	0.591	3.000	TM10075	–
0.80	M5	3	0.120	0.125	0.312	2.000	TM50080	TMMK0500-080
1.00	M6	3	0.170	0.187	0.500	2.500	TM60100	TMMK0600-100
1.00	M12	4	0.360	0.375	0.875	3.500	TM12100	TMMK1200-100
1.25	M8	3	0.235	0.250	0.625	2.500	TM80125	TMMK0800-125
1.50	M10	4	0.300	0.312	0.750	3.000	TM10150	TMMK1000-150
1.50	M14	4	0.370	0.375	0.875	3.500	TM14150	TMMK1400-150
1.50	M18	4	0.490	0.500	1.250	3.500	TM18150	TMMK1800-150
1.50	M20	5	0.620	0.625	1.418	4.000	TM20150	–
1.75	M12	4	0.360	0.375	0.875	3.500	TM12175	TMMK1200-175
2.00	M14	4	0.429	0.500	1.103	3.500	TM14200	–
2.00	M16	4	0.470	0.500	1.250	3.500	TM16200	TMMK1600-200
2.50	M20	4	0.495	0.500	1.250	3.500	TM20250	TMMK2000-250
3.00	M24	4	0.620	0.625	1.375	4.000	TM24300	TMMK2400-300
3.50	M30	4	0.620	0.625	1.516	4.000	TM30350	–
4.00	M36	5	0.745	0.750	1.575	4.500	TM36400	–

\*Straight fluted

E: 52 - 55

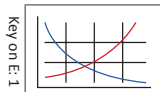

Key on E: 1

E: 4



Weldon Flat

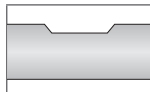

To order a thread mill with a Weldon flat, replace the leading TM designator with TW (available for inch shanks 3/8 and above, or metric shanks 6mm and above)

**Example:** Cylindrical shank = **TM**NK0500-NPT | Weldon shank flat = **TWN**K0500-NPT

**NOTE:** Weldon flats have a minimum order quantity of 2 pieces

**i** = Imperial (in)

**m** = Metric (mm)



### Solid Carbide Thread Mills

ISO | Coolant Through

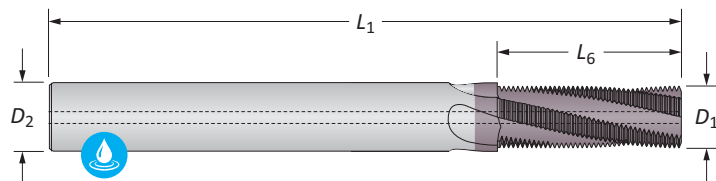
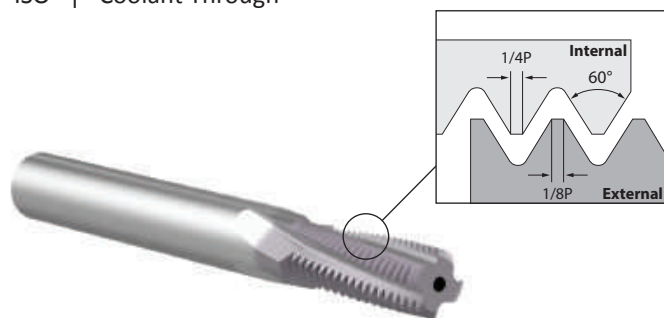

ISO | Coolant Through

Pitch	Min Thread $\phi$	Flutes	Thread Mill				Part No.
			$D_1$	$D_2$	$L_6$	$L_1$	
0.40	M2	3*	0.059	0.125	0.126	1.500	TM20040CH
0.45	M2.5	3*	0.059	0.125	0.142	1.500	TM25045CH
0.50	M3	3*	0.085	0.125	0.178	1.500	TM30050CH
0.50	M6	3	0.181	0.187	0.473	2.375	TM60050CH
0.50	M10	4	0.310	0.312	0.591	3.000	TM10050CH
0.70	M4	3	0.115	0.125	0.276	1.500	TM40070CH
0.75	M4.5	3	0.120	0.125	0.266	1.500	TM45075CH
0.75	M8	3	0.235	0.250	0.625	2.375	TM80075CH
0.75	M10	4	0.310	0.312	0.591	3.000	TM10075CH
0.80	M5	3	0.120	0.125	0.312	1.500	TM50080CH
1.00	M6	3	0.170	0.187	0.500	2.375	TM60100CH
1.00	M12	4	0.360	0.375	0.875	3.000	TM12100CH
1.25	M8	3	0.235	0.250	0.625	2.375	TM80125CH
1.50	M10	4	0.300	0.312	0.750	3.000	TM10150CH
1.50	M14	4	0.370	0.375	0.875	3.000	TM14150CH
1.50	M18	4	0.490	0.500	1.250	3.500	TM18150CH
1.50	M20	5	0.620	0.625	1.418	4.000	TM20150CH
1.75	M12	4	0.360	0.375	0.875	3.000	TM12175CH
2.00	M14	4	0.429	0.500	1.103	3.500	TM14200CH
2.00	M16	4	0.470	0.500	1.250	3.500	TM16200CH
2.50	M20	4	0.495	0.500	1.250	3.500	TM20250CH
3.00	M24	4	0.620	0.625	1.375	4.000	TM24300CH
3.50	M30	4	0.620	0.625	1.516	4.000	TM30350CH
4.00	M36	5	0.745	0.750	1.575	4.500	TM36400CH

i

\*Straight fluted

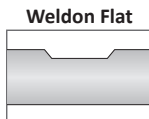
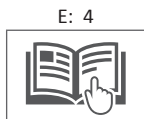
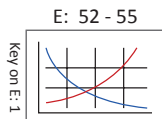

To order a thread mill with a Weldon flat, replace the leading TM designator with TW (available for inch shanks 3/8 and above, or metric shanks 6mm and above)  
**Example:** Cylindrical shank = **TM**NK0500-NPT | Weldon shank flat = **TW**NK0500-NPT  
**NOTE:** Weldon flats have a minimum order quantity of 2 pieces

i = Imperial (in)  
 m = Metric (mm)

## Solid Carbide Thread Mills

ISO | Non-Coolant

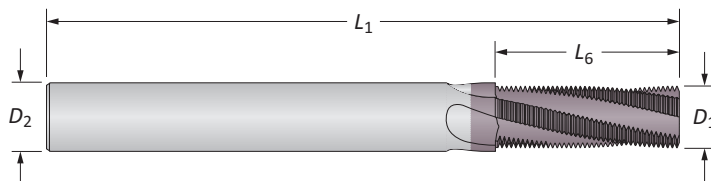
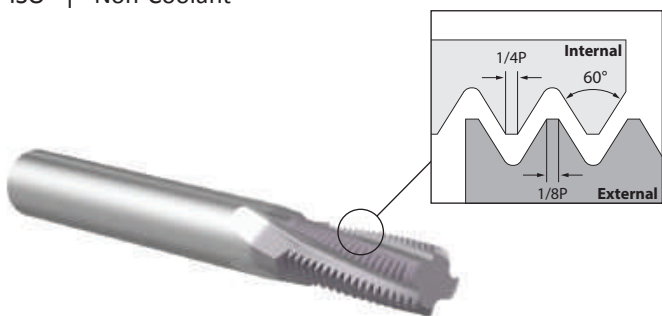

ISO | Non-Coolant

Pitch	Min Thread Ø	Flutes	Thread Mill				Part No.	
			D <sub>1</sub>	D <sub>2</sub>	L <sub>6</sub>	L <sub>1</sub>	ThreadMills USA	AccuThread™ 856
0.40	M2	3*	1.50	3.00	3.20	39.00	TM20040M	TMMK0200-040M
0.45	M2.5	3*	1.50	3.00	3.60	39.00	TM25045M	TMMK0250-045M
0.50	M3	3*	2.15	3.00	4.50	39.00	TM30050M	TMMK0300-050M
0.50	M6	3	4.60	6.00	12.00	58.00	TM60050M	TMMK0600-050M
0.50	M10	4	7.95	8.00	15.00	64.00	TM10050M	TMMK1000-050M
0.70	M4	3	2.90	3.00	8.00	39.00	TM40070M	TMMK0400-070M
0.75	M4.5	3	3.00	4.00	6.75	51.00	TM45075M	TMMK0450-075M
0.75	M6	3	4.60	6.00	12.00	58.00	TM60075M	TMMK0600-075M
0.75	M10	4	7.95	8.00	15.00	64.00	TM10075M	TMMK1000-075M
0.80	M5	3	3.60	4.00	8.00	51.00	TM50080M	TMMK0500-080M
1.00	M6	3	4.60	6.00	12.00	58.00	TM60100M	TMMK0600-100M
1.00	M12	4	9.40	10.00	20.00	73.00	TM12100M	TMMK1200-100M
1.25	M8	3	5.90	6.00	16.25	58.00	TM80125M	TMMK0800-125M
1.50	M10	4	7.40	8.00	19.50	64.00	TM10150M	TMMK1000-150M
1.50	M14	4	10.90	12.00	27.00	84.00	TM14150M	TMMK1400-150M
1.50	M18	4	11.90	12.00	31.50	84.00	TM18150M	TMMK1800-150M
1.50	M20	5	15.75	16.00	36.00	93.00	TM20150M	-
1.75	M12	4	9.40	10.00	22.71	73.00	TM12175M	TMMK1200-175M
2.00	M14	4	10.90	12.00	28.00	84.00	TM14200M	TMMK1400-200M
2.00	M16	4	11.95	12.00	30.00	84.00	TM16200M	TMMK2000-200M
2.50	M20	4	11.90	12.00	30.00	84.00	TM20250M	TMMK2000-250M
3.00	M24	4	15.90	16.00	36.00	93.00	TM24300M	TMMK2400-300M
3.50	M30	4	15.75	16.00	38.50	100.00	TM30350M	TMMK3000-350M
4.00	M36	5	19.90	20.00	40.00	105.00	TM36400M	TMMK3600-400M

\*Straight fluted

E THREADING

X SPECIALS

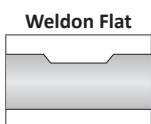
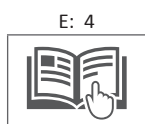
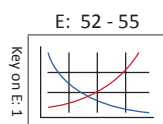

To order a thread mill with a Weldon flat, replace the leading TM designator with TW (available for inch shanks 3/8 and above, or metric shanks 6mm and above)  
**Example:** Cylindrical shank = **TW**NK0500-NPT | Weldon shank flat = **TWN**K0500-NPT  
**NOTE:** Weldon flats have a minimum order quantity of 2 pieces

ⓘ = Imperial (in)  
 ⓘ = Metric (mm)



### Solid Carbide Thread Mills

ISO | Coolant Through

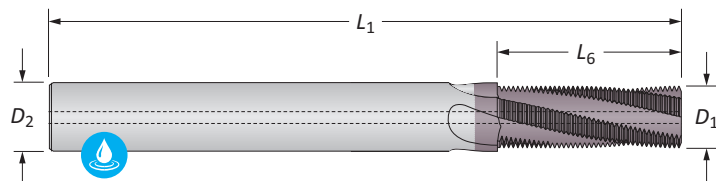
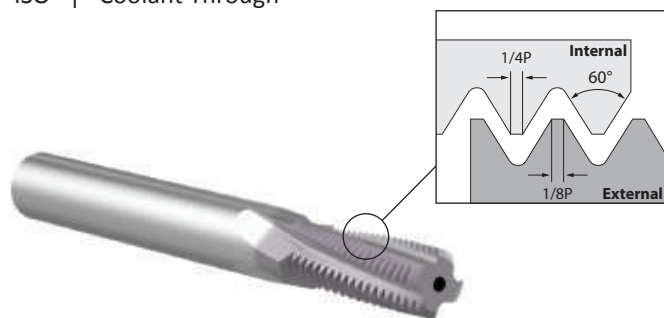

ISO | Coolant Through

Pitch	Min Thread $\phi$	Flutes	Thread Mill				Part No.
			$D_1$	$D_2$	$L_6$	$L_1$	ThreadMills USA
0.40	M2	3*	1.50	3.00	3.20	39.00	TM20040CHM
0.45	M2.5	3*	1.50	3.00	3.60	39.00	TM25045CHM
0.50	M3	3*	2.15	3.00	4.50	39.00	TM30050CHM
0.50	M6	3	4.60	6.00	12.00	58.00	TM60050CHM
0.50	M10	4	7.95	8.00	15.00	64.00	TM10050CHM
0.70	M4	3	2.90	3.00	8.00	39.00	TM40070CHM
0.75	M4.5	3	3.00	4.00	6.75	51.00	TM45075CHM
0.75	M6	3	4.60	6.00	12.00	58.00	TM60075CHM
0.75	M10	4	7.95	8.00	15.00	64.00	TM10075CHM
0.80	M5	3	3.60	4.00	8.00	51.00	TM50080CHM
1.00	M6	3	4.60	6.00	12.00	58.00	TM60100CHM
1.00	M12	4	9.40	10.00	20.00	84.00	TM12100CHM
1.25	M8	3	5.90	6.00	16.25	58.00	TM80125CHM
1.50	M10	4	7.40	8.00	19.50	64.00	TM10150CHM
1.50	M14	4	10.90	12.00	27.00	84.00	TM14150CHM
1.50	M18	4	11.90	12.00	31.50	84.00	TM18150CHM
1.50	M20	5	15.75	16.00	36.00	93.00	TM20150CHM
1.75	M12	4	9.40	10.00	22.71	84.00	TM12175CHM
2.00	M14	4	10.90	12.00	28.00	84.00	TM14200CHM
2.00	M16	4	11.95	12.00	30.00	84.00	TM16200CHM
2.50	M20	4	11.90	12.00	30.00	84.00	TM20250CHM
3.00	M24	4	15.90	16.00	36.00	93.00	TM24300CHM
3.50	M30	4	15.75	16.00	38.50	100.00	TM30350CHM
4.00	M36	5	19.90	20.00	40.00	105.00	TM36400CHM

\*Straight fluted

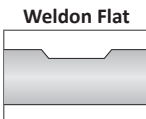
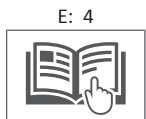
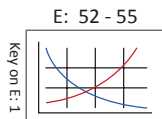

To order a thread mill with a Weldon flat, replace the leading TM designator with TW (available for inch shanks 3/8 and above, or metric shanks 6mm and above)  
**Example:** Cylindrical shank = **TM**NK0500-NPT | Weldon shank flat = **TW**NK0500-NPT  
**NOTE:** Weldon flats have a minimum order quantity of 2 pieces

**I** = Imperial (in)  
**M** = Metric (mm)

## Solid Carbide Thread Mills

UN | 2xD

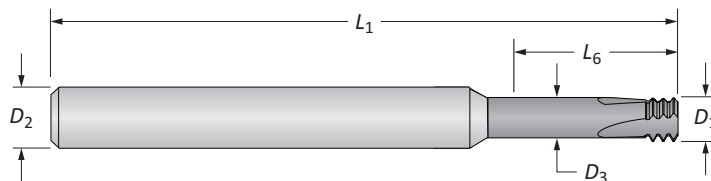
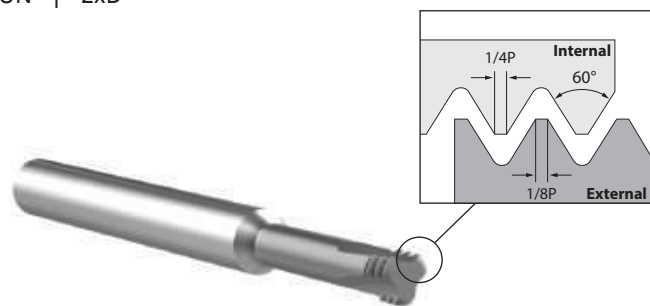

UN | Non-Coolant

TPI (Pitch)	Min Thread Ø	Flutes	Thread Mill					Part No.
			$D_1$	$D_3$	$D_2$	$L_6$	$L_1$	
								<b>AccuThread T3</b>
64	#1	3	0.055	0.035	0.250	0.150	2.500	<b>TM07364-3T2X</b>
56	#2	3	0.065	0.042	0.250	0.170	2.500	<b>TM08656-3T2X</b>
48	#3	3	0.075	0.049	0.250	0.200	2.500	<b>TM09948-3T2X</b>
40	#4	3	0.085	0.054	0.250	0.250	2.500	<b>TM11240-3T2X</b>
36	#8	3	0.130	0.095	0.250	0.350	2.500	<b>TM16436-3T2X</b>
32	#6	3	0.100	0.061	0.250	0.280	2.500	<b>TM13832-3T2X</b>
32	#8	3	0.126	0.087	0.250	0.370	2.500	<b>TM16432-3T2X</b>
32	#10	3	0.145	0.106	0.250	0.410	2.500	<b>TM19032-3T2X</b>
<b>i</b> 28	1/4	3	0.197	0.153	0.250	0.570	2.500	<b>TM25028-3T2X</b>
24	#10	3	0.138	0.086	0.250	0.420	2.500	<b>TM19024-3T2X</b>
24	5/16	3	0.260	0.208	0.312	0.670	2.500	<b>TM31224-3T2X</b>
20	1/4	3	0.187	0.125	0.250	0.550	2.500	<b>TM25020-3T2X</b>
20	7/16	4	0.312	0.250	0.312	0.980	2.500	<b>TM43720-3T2X</b>
18	5/16	3	0.236	0.168	0.250	0.670	2.500	<b>TM31218-3T2X</b>
16	3/8	3	0.264	0.187	0.312	0.870	2.500	<b>TM37516-3T2X</b>
14	7/16	4	0.300	0.212	0.312	0.980	2.500	<b>TM43714-3T2X</b>
13	1/2	4	0.360	0.266	0.375	1.080	3.000	<b>TM50013-3T2X</b>
12	9/16	4	0.410	0.308	0.500	1.240	3.500	<b>TM56212-3T2X</b>
64	#1	3	1.40	0.89	6.00	3.81	63.00	<b>TM07364M-3T2X</b>
56	#2	3	1.65	1.08	6.00	4.32	63.00	<b>TM08656M-3T2X</b>
48	#3	3	1.91	1.24	6.00	5.08	63.00	<b>TM09948M-3T2X</b>
40	#4	3	2.16	1.36	6.00	6.35	63.00	<b>TM11240M-3T2X</b>
36	#8	3	3.30	2.42	6.00	8.89	63.00	<b>TM16436M-3T2X</b>
32	#6	3	2.54	1.55	6.00	7.11	63.00	<b>TM13832M-3T2X</b>
32	#8	3	3.20	2.21	6.00	9.40	63.00	<b>TM16432M-3T2X</b>
<b>m</b> 32	#10	3	3.68	2.70	6.00	10.41	63.00	<b>TM19032M-3T2X</b>
28	1/4	3	5.00	3.88	6.00	14.48	63.00	<b>TM25028M-3T2X</b>
24	#10	3	3.51	2.20	6.00	10.67	63.00	<b>TM19024M-3T2X</b>
24	5/16	3	6.60	5.30	8.00	17.02	64.00	<b>TM31224M-3T2X</b>
20	1/4	3	4.75	3.18	6.00	13.97	63.00	<b>TM25020M-3T2X</b>
20	7/16	4	7.92	6.36	8.00	24.89	64.00	<b>TM43720M-3T2X</b>
18	5/16	3	5.94	4.26	6.00	17.02	63.00	<b>TM31218M-3T2X</b>
16	3/8	3	6.71	4.76	8.00	22.10	64.00	<b>TM37516M-3T2X</b>
14	7/16	4	7.62	5.39	8.00	24.89	64.00	<b>TM43714M-3T2X</b>

E: 56 - 57

E: 4

Key on E: 1

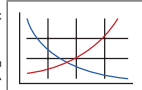

**i** = Imperial (in)  
**m** = Metric (mm)

### Solid Carbide Thread Mills

UN | 3xD

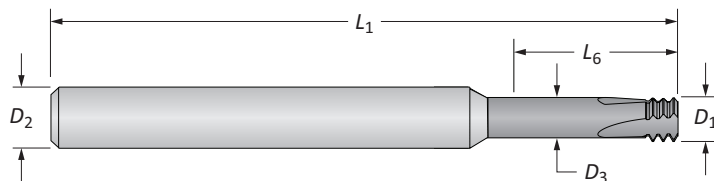
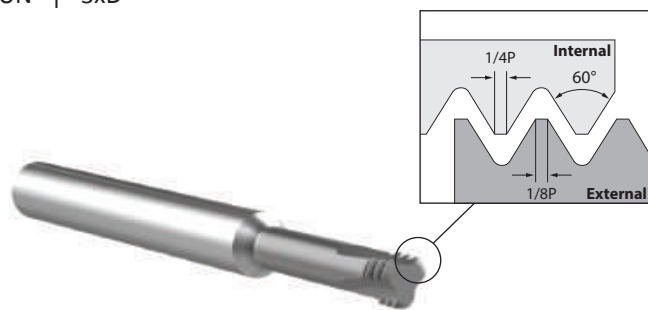

UN | Non-Coolant

	TPI (Pitch)	Min Thread $\phi$	Flutes	Thread Mill					Part No.
				$D_1$	$D_3$	$D_2$	$L_6$	$L_1$	AccuThread T3
i	40	#4	3	0.085	0.054	0.250	0.310	2.500	TM11240-3T3X
	32	#6	3	0.100	0.061	0.250	0.410	2.500	TM13832-3T3X
	32	#10	3	0.145	0.106	0.250	0.590	2.500	TM19032-3T3X
	28	1/4	3	0.197	0.153	0.250	0.750	2.500	TM25028-3T3X
	24	#10	3	0.138	0.086	0.250	0.590	2.500	TM19024-3T3X
	24	5/16	3	0.260	0.208	0.312	0.940	2.500	TM31224-3T3X
	20	1/4	3	0.187	0.125	0.250	0.750	2.500	TM25020-3T3X
	18	5/16	3	0.236	0.168	0.250	0.910	2.500	TM31218-3T3X
m	40	#4	3	2.16	1.36	6.00	7.87	63.00	TM11240M-3T3X
	32	#6	3	2.54	1.55	6.00	10.41	63.00	TM13832M-3T3X
	32	#10	3	3.68	2.70	6.00	14.99	63.00	TM19032M-3T3X
	28	1/4	3	5.00	3.88	6.00	19.05	63.00	TM25028M-3T3X
	24	#10	3	3.51	2.20	6.00	14.99	63.00	TM19024M-3T3X
	24	5/16	3	6.60	5.30	8.00	23.88	64.00	TM31224M-3T3X
	20	1/4	3	4.75	3.18	6.00	19.05	63.00	TM25020M-3T3X
	18	5/16	3	5.94	4.21	6.00	23.11	63.00	TM31218M-3T3X

A

DRILLING

B

BORING

C

REAMING

D

BURNISHING

E

THREADING

X

SPECIALS

E: 56 - 57

E: 4

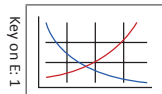

i = Imperial (in)  
m = Metric (mm)

## Solid Carbide Thread Mills

ISO | 2xD

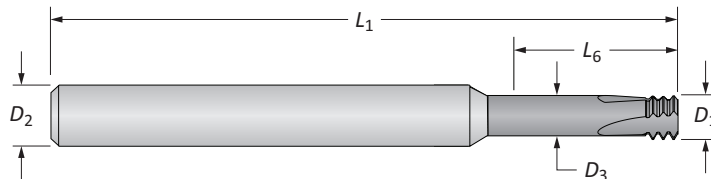
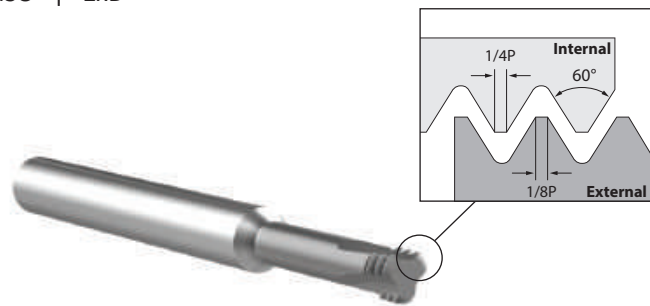

ISO | Non-Coolant

Pitch	Min Thread Ø	Flutes	Thread Mill					Part No.
			$D_1$	$D_3$	$D_2$	$L_6$	$L_1$	
0.35	M1.8	3	0.053	0.033	0.250	0.170	2.500	 <b>TM18035-3T2X</b>
0.40	M2	3	0.061	0.041	0.250	0.180	2.500	<b>TM20040-3T2X</b>
0.45	M2.5	3	0.077	0.055	0.250	0.220	2.500	<b>TM25045-3T2X</b>
0.50	M3	3	0.093	0.068	0.250	0.260	2.500	<b>TM30050-3T2X</b>
0.60	M3.5	3	0.108	0.078	0.250	0.300	2.500	<b>TM35060-3T2X</b>
0.70	M4	3	0.122	0.088	0.250	0.350	2.500	<b>TM40070-3T2X</b>
0.75	M4.5	3	0.133	0.095	0.250	0.430	2.500	<b>TM45075-3T2X</b>
0.80	M5	3	0.150	0.111	0.250	0.490	2.500	<b>TM50080-3T2X</b>
1.00	M6	3	0.183	0.134	0.250	0.550	2.500	<b>TM60100-3T2X</b>
1.25	M8	3	0.234	0.173	0.250	0.710	2.500	<b>TM80125-3T2X</b>
1.50	M10	4	0.307	0.234	0.312	0.910	2.500	<b>TM10150-3T2X</b>
1.75	M12	4	0.310	0.225	0.312	0.945	2.500	<b>TM12175-3T2X</b>
0.35	M1.8	3	1.35	0.84	6.00	4.32	63.00	<b>TM18035M-3T2X</b>
0.40	M2	3	1.55	1.04	6.00	4.60	63.00	<b>TM20040M-3T2X</b>
0.45	M2.5	3	1.96	1.38	6.00	5.60	63.00	<b>TM25045M-3T2X</b>
0.50	M3	3	2.36	1.73	6.00	6.60	63.00	<b>TM30050M-3T2X</b>
0.60	M3.5	3	2.74	1.99	6.00	7.60	63.00	<b>TM35060M-3T2X</b>
0.70	M4	3	3.10	2.22	6.00	8.90	63.00	<b>TM40070M-3T2X</b>
0.75	M4.5	3	3.38	2.41	6.00	10.92	63.00	<b>TM45075M-3T2X</b>
0.80	M5	3	3.81	2.81	6.00	12.40	63.00	<b>TM50080M-3T2X</b>
1.00	M6	3	4.65	3.41	6.00	14.00	63.00	<b>TM60100M-3T2X</b>
1.25	M8	3	5.94	4.40	6.00	18.00	63.00	<b>TM80125M-3T2X</b>
1.50	M10	4	7.80	5.95	8.00	23.10	64.00	<b>TM10150M-3T2X</b>
1.75	M12	4	7.92	5.78	8.00	24.00	64.00	<b>TM12175M-3T2X</b>

A

DRILLING

B

BORING

C

REAMING

D

BURNISHING

E

THREADING

X

SPECIALS

E: 56 - 57

E: 4

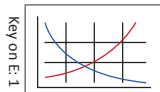

**i** = Imperial (in)  
**m** = Metric (mm)





### Solid Carbide Thread Mills

ISO | 3xD

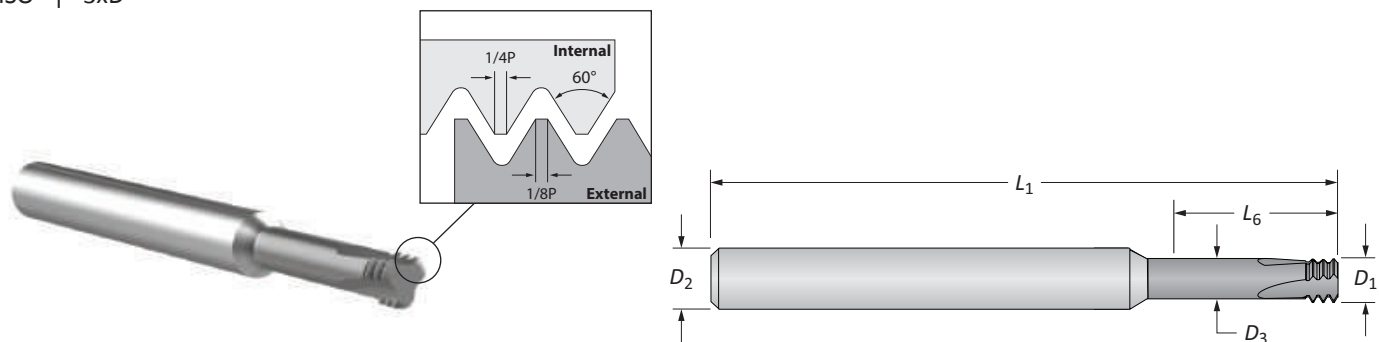

ISO | Non-Coolant

	Pitch	Min Thread $\phi$	Flutes	Thread Mill					Part No.
				$D_1$	$D_3$	$D_2$	$L_6$	$L_1$	AccuThread T3
i	0.45	M2.5	3	0.077	0.055	0.250	0.300	2.500	TM25045-3T3X
	0.50	M3	3	0.093	0.068	0.250	0.370	2.500	TM30050-3T3X
	0.60	M3.5	3	0.108	0.078	0.250	0.450	2.500	TM35060-3T3X
	0.70	M4	3	0.122	0.088	0.250	0.490	2.500	TM40070-3T3X
	0.80	M5	3	0.150	0.111	0.250	0.630	2.500	TM50080-3T3X
	1.00	M6	3	0.183	0.134	0.250	0.790	2.500	TM60100-3T3X
	1.25	M8	3	0.234	0.173	0.250	0.940	2.500	TM80125-3T3X
	1.50	M10	4	0.307	0.234	0.312	1.120	2.500	TM10150-3T3X
	1.75	M12	4	0.310	0.225	0.312	1.418	2.500	TM12175-3T3X
m	0.45	M2.5	3	1.96	1.38	6.00	7.60	63.00	TM25045M-3T3X
	0.50	M3	3	2.36	1.73	6.00	9.40	63.00	TM30050M-3T3X
	0.60	M3.5	3	2.74	1.99	6.00	11.40	63.00	TM35060M-3T3X
	0.70	M4	3	3.10	2.22	6.00	12.40	63.00	TM40070M-3T3X
	0.80	M5	3	3.81	2.81	6.00	16.00	63.00	TM50080M-3T3X
	1.00	M6	3	4.65	3.41	6.00	20.10	63.00	TM60100M-3T3X
	1.25	M8	3	5.94	4.40	6.00	23.90	63.00	TM80125M-3T3X
	1.50	M10	4	7.80	5.95	8.00	28.40	64.00	TM10150M-3T3X
	1.75	M12	4	7.92	5.78	8.00	36.00	64.00	TM12175M-3T3X

E: 56 - 57

E: 4

Key on E: 1

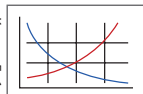

i = Imperial (in)  
m = Metric (mm)

## Indexable Insert Thread Mills Overview

A DRILLING  
B BORING  
C REAMING  
D BURNISHING  
E THREADING  
X SPECIALS



### Bolt-in Style

- Replaceable inserts allow for quick set-ups and tool changes to keep the production process moving smoothly
- Inserts are available with AM210® coating, which increases tool life
- Available with 1 flute only
- Multiple thread form styles are available
- Tapered thread forms: NPT, NPTF, BSPT
- Straight thread forms: BSPP, UN, UNJ, ISO

#### Bolt-in Style Indexable Thread Mill Assembly



**Step 1:**  
Slide the thread mill insert into the insert holder slot.

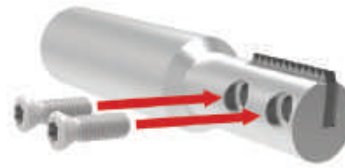

**Step 2:**  
Tighten the screws to hold the insert in place.

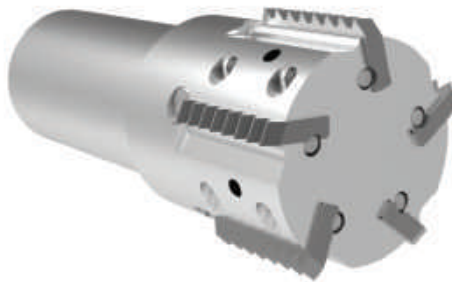

### Pin Style

- Replaceable inserts allow for quick set-ups and tool changes to keep the production process moving smoothly
- Inserts are available with AM210® coating, which increases tool life
- Holders available in 2 styles: Weldon Shank and Shell Mill
- Weldon Shank holders available with 1, 2, 3, and 5 flutes
- Shell Mill holders available with 6, 7, and 8 flutes
- Thread forms available: NPT, NPTF, BSPT, BSPP, API-ROUND, ACME, UN, UNJ, ISO

#### Pin Style Indexable Thread Mill Assembly



**Step 1:**  
Slide the thread mill insert into the insert holder slot.



**Step 2:**  
Slide the pin into the pin holder slot to hold the insert in place.

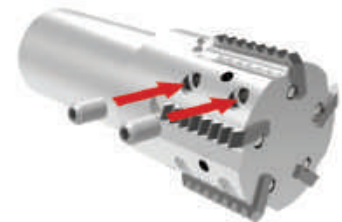

**Step 3:**  
Tighten the screws to hold both the insert and pin in place.

## Product Nomenclature

### AccuThread™ 856 Indexable Inserts

<b>TP</b>	<b>075</b>	<b>K</b>	-	<b>UN</b>	<b>32</b>	<b>I</b>
1	2	3		4	5	6



Bolt-in Style



Pin Style

1. Insert Style	2. Insert Length	3. Coating	4. Thread Class	5. Thread Pitch	6. Thread Style
<b>TP</b> = Bolt-in <b>TN</b> = Pin style	<b>075</b> = 3/4 <b>100</b> = 1.00 <b>150</b> = 1.50	<b>K</b> = AM210® <b>A</b> = TiAlN <b>U</b> = Uncoated	<b>UN</b> = UN <b>BSPT</b> = BSPT <b>UNJ</b> = UNJ <b>M</b> = ISO <b>NPT</b> = NPT <b>FA</b> = Full ACME <b>NPTF</b> = NPTF <b>AP</b> = API Round <b>BSPP</b> = BSPP	<b>20</b> = UN <b>1.0</b> = ISO	<b>I</b> = Internal <b>E</b> = External

### Indexable Inserts

Symbol	Attribute
$L_6$	Length of insert
$T_1$	Insert thickness

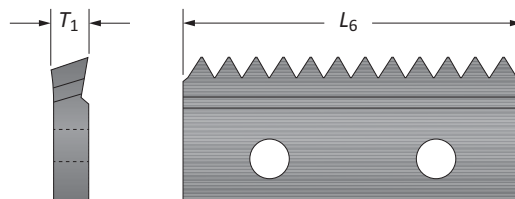

### AccuThread™ 856 Indexable Insert Holders

<b>THT</b>	-	<b>0400</b>	-	<b>1F</b>	<b>075</b>	<b>M</b>
1		2		3	4	5

1. Holder Style	
<b>Bolt-in Style</b>	<b>Pin Style</b>
<b>THT</b> = Tapered Head	<b>THP</b> = Weldon Positive Rake
<b>THN</b> = Straight Head	<b>TNR</b> = Weldon Neutral Rake
	<b>TSN</b> = Shell Mill Positive Rake
	<b>TSR</b> = Shell Mill Neutral Rake

2. Cutter Diameter	3. Shank Designation
<b>0400</b> = 0.400	<b>1F</b> = 1 flute <b>6F</b> = 6 flutes <b>2F</b> = 2 flutes <b>7F</b> = 7 flutes <b>3F</b> = 3 flutes <b>8F</b> = 8 flutes <b>5F</b> = 5 flutes

4. Length of Insert	5. Shank Designation
<b>075</b> = 3/4 <b>100</b> = 1.00 <b>150</b> = 1.50	<b>Blank</b> = Inch <b>M</b> = Metric

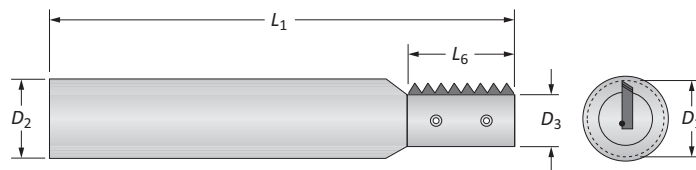

### Bolt-in Style Holders

Symbol	Attribute	Symbol	Attribute
$D_1$	Maximum cutter diameter	$L_1$	Overall length
$D_2$	Shank diameter	$L_6$	Length of insert
$D_3$	Pilot diameter		

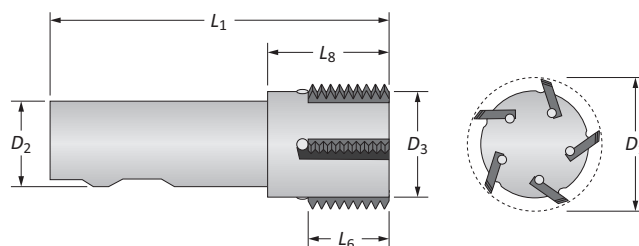

### Pin Style Holders

Symbol	Attribute	Symbol	Attribute
$D_1$	Cutter diameter	$D_5$	Bore diameter (Shell Mill)
$D_1^*$	Oversized cutter diameter	$L_1$	Overall length
$D_2$	Shank diameter	$L_6$	Length of insert
$D_3$	Pilot diameter	$L_8$	Flute length
$D_4$	Body diameter (Shell Mill)	$T_2$	Slot width (Shell Mill)

A

### AccuThread™ 856 Thread Mill Inserts

Bolt-in Style | NPT / NPTF

DRILLING

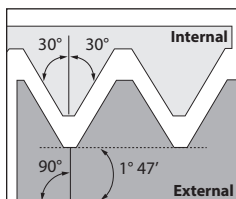

**NPT**  
Internal / External

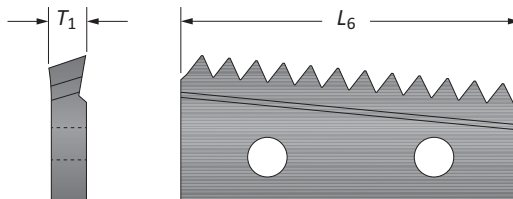

B

BORING

TPI (Pitch)	Insert				Part No.
	$L_6$ inch	$L_6$ mm	$T_1$ inch	$T_1$ mm	NPT Internal/External
18	0.750	19.05	0.080	2.03	<b>TP075K-NPT18</b>
14	1.000	25.40	0.140	3.56	<b>TP100K-NPT14</b>

C

REAMING

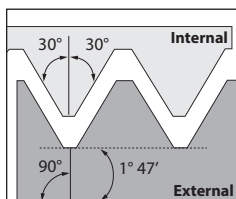

**NPTF**  
Internal / External

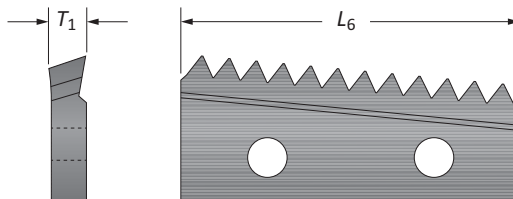

TPI (Pitch)	Insert				Part No.
	$L_6$ inch	$L_6$ mm	$T_1$ inch	$T_1$ mm	NPTF Internal/External
18	0.750	19.05	0.080	2.03	<b>TP075K-NPTF18</b>
14	1.000	25.40	0.140	3.56	<b>TP100K-NPTF14</b>

D

BURNISHING

E

THREADING

X

SPECIALS

E: 58 - 61

E: 34

E: 41

Key on E: 1

Inserts sold in quantities of 2



# AccuThread™ 856 Thread Mill Inserts

Bolt-in Style | BSPT / BSPP

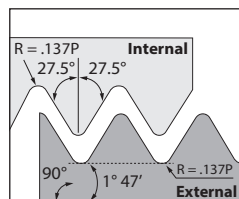

**BSPT**  
Internal / External

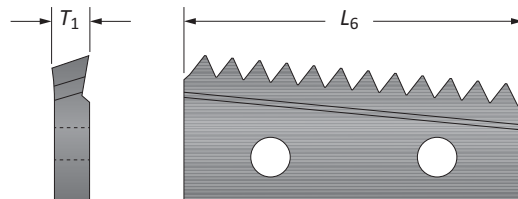

TPI (Pitch)	Insert				Part No.
	$L_6$ inch	$L_6$ mm	$T_1$ inch	$T_1$ mm	BSPT Internal/External
19	0.750	19.05	0.080	2.03	<b>TP075K-BSPT19</b>
19	1.000	25.40	0.140	3.56	<b>TP100K-BSPT19</b>
14	1.000	25.40	0.140	3.56	<b>TP100K-BSPT14</b>

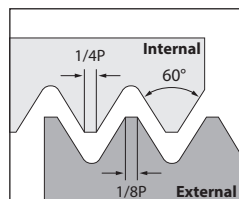

**BSPP**  
Internal / External

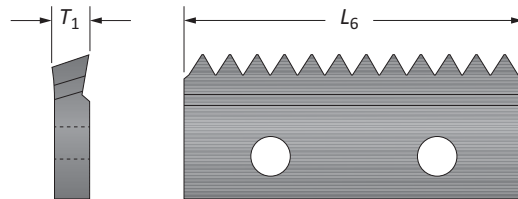

TPI (Pitch)	Insert				Part No.
	$L_6$ inch	$L_6$ mm	$T_1$ inch	$T_1$ mm	BSPP Internal/External
19	0.750	19.05	0.080	2.03	<b>TP075K-BSPP19</b>
19	1.000	25.40	0.140	3.56	<b>TP100K-BSPP19</b>
14	1.000	25.40	0.140	3.56	<b>TP100K-BSPP14</b>

A

DRILLING

B

BORING

C

REAMING

D

BURNISHING

E

THREADING

X

SPECIALS

E: 58 - 61 E: 34 E: 41

Key on E: 1

Inserts sold in quantities of 2

## AccuThread™ 856 Thread Mill Inserts

Bolt-in Style | UN

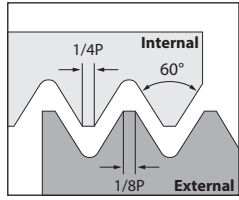

**UN**  
Internal

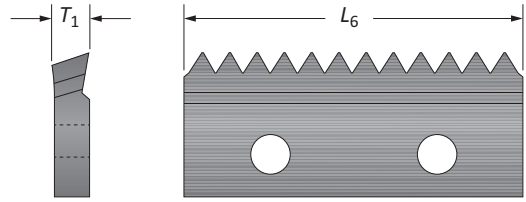

TPI (Pitch)	Insert				Part No. UN Internal
	L <sub>6</sub> inch	L <sub>6</sub> mm	T <sub>1</sub> inch	T <sub>1</sub> mm	
32	0.750	19.05	0.080	2.03	TP075K-UN32I
32	1.000	25.40	0.140	3.56	TP100K-UN32I
24	0.750	19.05	0.080	2.03	TP075K-UN24I
24	1.000	25.40	0.140	3.56	TP100K-UN24I
20	0.750	19.05	0.080	2.03	TP075K-UN20I
20	1.000	25.40	0.140	3.56	TP100K-UN20I
18	0.750	19.05	0.080	2.03	TP075K-UN18I
18	1.000	25.40	0.140	3.56	TP100K-UN18I
16	0.750	19.05	0.080	2.03	TP075K-UN16I
16	1.000	25.40	0.140	3.56	TP100K-UN16I
14	1.000	25.40	0.140	3.56	TP100K-UN14I
13	1.000	25.40	0.140	3.56	TP100K-UN13I
12	1.000	25.40	0.140	3.56	TP100K-UN12I
10*	1.000	25.40	0.140	3.56	TP100K-UN10I*

\*This item is only used with THN-0611-1F100. The reduced body allows a 3/4"-10 UN/UNJ to be produced.

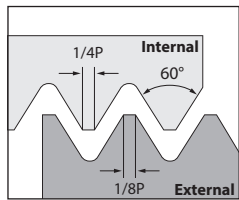

**UN**  
External

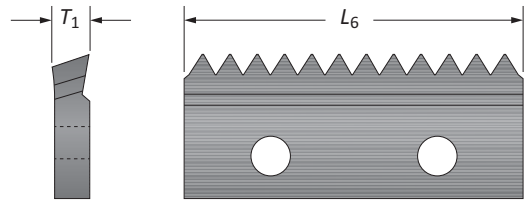

TPI (Pitch)	Insert				Part No. UN External
	L <sub>6</sub> inch	L <sub>6</sub> mm	T <sub>1</sub> inch	T <sub>1</sub> mm	
32	0.750	19.05	0.080	2.03	TP075K-UN32E
32	1.000	25.40	0.140	3.56	TP100K-UN32E
24	0.750	19.05	0.080	2.03	TP075K-UN24E
24	1.000	25.40	0.140	3.56	TP100K-UN24E
20	0.750	19.05	0.080	2.03	TP075K-UN20E
20	1.000	25.40	0.140	3.56	TP100K-UN20E
18	0.750	19.05	0.080	2.03	TP075K-UN18E
18	1.000	25.40	0.140	3.56	TP100K-UN18E
16	0.750	19.05	0.080	2.03	TP075K-UN16E
16	1.000	25.40	0.140	3.56	TP100K-UN16E
14	1.000	25.40	0.140	3.56	TP100K-UN14E
13	1.000	25.40	0.140	3.56	TP100K-UN13E
12	1.000	25.40	0.140	3.56	TP100K-UN12E
10*	1.000	25.40	0.140	3.56	TP100K-UN10E*

\*This item is only used with THN-0611-1F100. The reduced body allows a 3/4"-10 UN/UNJ to be produced.

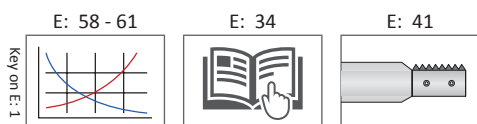

Inserts sold in quantities of 2



# AccuThread™ 856 Thread Mill Inserts

Bolt-in Style | UNJ

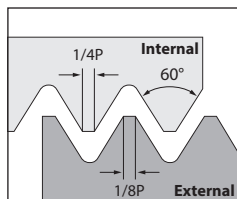

**UNJ**  
Internal

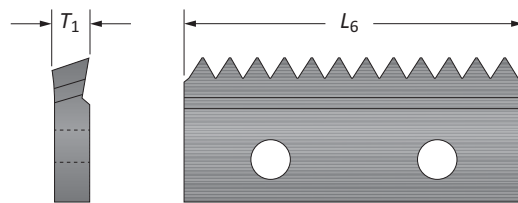

TPI (Pitch)	Insert				Part No.
	L <sub>6</sub> inch	L <sub>6</sub> mm	T <sub>1</sub> inch	T <sub>1</sub> mm	UNJ Internal
32	0.750	19.05	0.080	2.03	TP075K-UNJ32I
32	1.000	25.40	0.140	3.56	TP100K-UNJ32I
24	0.750	19.05	0.080	2.03	TP075K-UNJ24I
24	1.000	25.40	0.140	3.56	TP100K-UNJ24I
20	0.750	19.05	0.080	2.03	TP075K-UNJ20I
20	1.000	25.40	0.140	3.56	TP100K-UNJ20I
18	0.750	19.05	0.080	2.03	TP075K-UNJ18I
18	1.000	25.40	0.140	3.56	TP100K-UNJ18I
16	0.750	19.05	0.080	2.03	TP075K-UNJ16I
16	1.000	25.40	0.140	3.56	TP100K-UNJ16I
14	1.000	25.40	0.140	3.56	TP100K-UNJ14I
12	1.000	25.40	0.140	3.56	TP100K-UNJ12I
10*	1.000	25.40	0.140	3.56	TP100K-UNJ10I*

\*This item is only used with THN-0611-1F100. The reduced body allows a 3/4"-10 UN/UNJ to be produced.

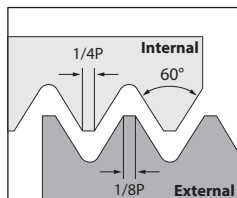

**UNJ**  
External

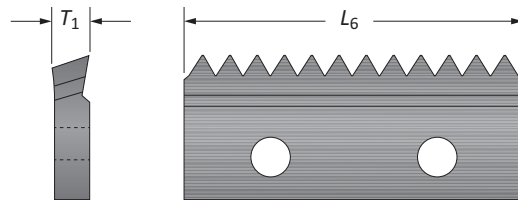

TPI (Pitch)	Insert				Part No.
	L <sub>6</sub> inch	L <sub>6</sub> mm	T <sub>1</sub> inch	T <sub>1</sub> mm	UNJ External
32	0.750	19.05	0.080	2.03	TP075K-UNJ32E
32	1.000	25.40	0.140	3.56	TP100K-UNJ32E
24	0.750	19.05	0.080	2.03	TP075K-UNJ24E
24	1.000	25.40	0.140	3.56	TP100K-UNJ24E
20	0.750	19.05	0.080	2.03	TP075K-UNJ20E
20	1.000	25.40	0.140	3.56	TP100K-UNJ20E
18	0.750	19.05	0.080	2.03	TP075K-UNJ18E
18	1.000	25.40	0.140	3.56	TP100K-UNJ18E
16	0.750	19.05	0.080	2.03	TP075K-UNJ16E
16	1.000	25.40	0.140	3.56	TP100K-UNJ16E
12	1.000	25.40	0.140	3.56	TP100K-UNJ12E

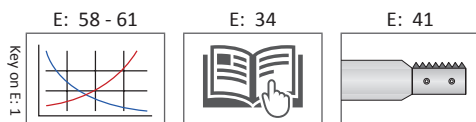

Inserts sold in quantities of 2

A DRILLING  
B BORING  
C REAMING  
D BURNISHING  
E THREADING  
X SPECIALS

## AccuThread™ 856 Thread Mill Inserts

Bolt-in Style | ISO

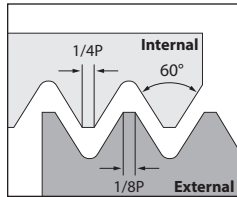

**ISO**  
Internal

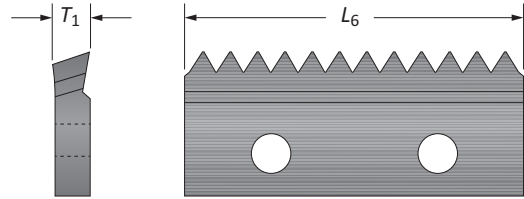

Pitch	Insert					Part No.
	$L_6$ inch	$L_6$ mm	$T_1$ inch	$T_1$ mm	ISO Internal	
0.5	0.750	19.05	0.080	2.03	<b>TP075K-M0.5I</b>	
1.0	0.750	19.05	0.080	2.03	<b>TP075K-M1.0I</b>	
1.0	1.000	24.40	0.140	3.56	<b>TP100K-M1.0I</b>	
1.25	0.750	19.05	0.080	2.03	<b>TP075K-M1.25I</b>	
1.5	0.750	19.05	0.080	2.03	<b>TP075K-M1.5I</b>	
1.5	1.000	25.40	0.140	3.56	<b>TP100K-M1.5I</b>	
2.0	1.000	25.40	0.140	3.56	<b>TP100K-M2.0I</b>	

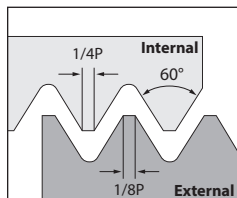

**ISO**  
External

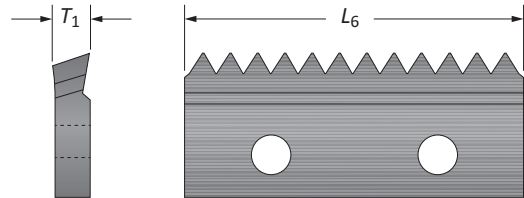

Pitch	Insert					Part No.
	$L_6$ inch	$L_6$ mm	$T_1$ inch	$T_1$ mm	ISO External	
1.0	1.000	24.40	0.140	3.56	<b>TP100K-M1.0E</b>	
1.5	1.000	25.40	0.140	3.56	<b>TP100K-M1.5E</b>	
2.0	1.000	25.40	0.140	3.56	<b>TP100K-M2.0E</b>	

E: 58 - 61      E: 34      E: 41

Key on E: 1

Inserts sold in quantities of 2





## AccuThread™ 856 Thread Mill Insert Holders

Bolt-in Style

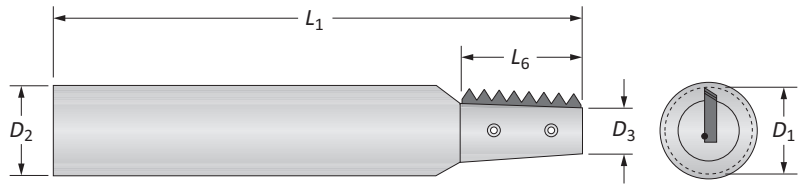

### Tapered Insert Holders | NPT / NPTF / BSPT

	Holder					Flutes	Part No.	Inserts	Screw	Wrench
	$D_1$	$D_3$	$D_2$	$L_6$	$L_1$					
i	0.400	0.229	0.500	0.750	3.000	1	<b>THT-0400-1F075</b>	TP075K...	TMS-250	8T-8
	0.659	0.379	0.500	1.000	3.000	1	<b>THT-0659-1F100</b>	TP100K...	TMS-45	8T-9
m	10.16	5.82	13.00	19.05	76.20	1	<b>THT-0400-1F075M</b>	TP075K...	TMS-250	8T-8
	16.74	9.65	13.00	25.40	76.20	1	<b>THT-0659-1F100M</b>	TP100K...	TMS-45	8T-9

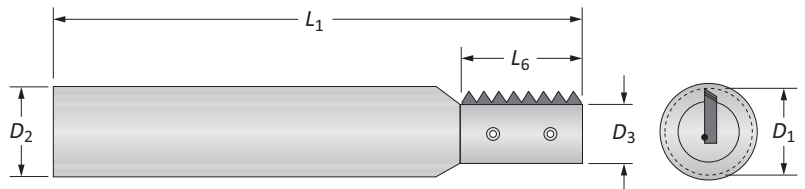

### Straight Insert Holders | BSPP / UN / UNJ / ISO

	Holder					Flutes	Part No.	Inserts	Screw	Wrench
	$D_1$	$D_3$	$D_2$	$L_6$	$L_1$					
i	0.394	0.250	0.500	0.750	3.000	1	<b>THN-0394-1F075</b>	TP075K...	TMS-250	8T-8
	0.611	0.383	0.750	1.000	3.500	1	<b>THN-0611-1F100</b>	*SEE NOTE	TMS-40	8T-9
	0.625	0.454	0.750	1.000	3.500	1	<b>THN-0625-1F100</b>	TP100K...	TMS-40	8T-9
m	10.01	6.35	13.00	19.05	76.20	1	<b>THN-0394-1F075M</b>	TP075K...	TMS-250	8T-8
	15.88	11.58	25.00	25.40	88.90	1	<b>THN-0625-1F100M</b>	TP100K...	TMS-40	8T-9

\*NOTE: Only UN/UNJ 10 TPI inserts can be used in this holder. Please refer to inserts on pages E: 38-39.

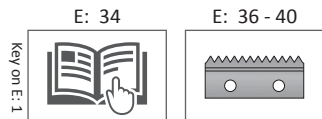

i = Imperial (in)  
m = Metric (mm)

A DRILLING  
B BORING  
C REAMING  
D BURNISHING  
E THREADING  
X SPECIALS

## AccuThread™ 856 Thread Mill Inserts

Pin Style | NPT / NPTF / BSPT

A  
DRILLING

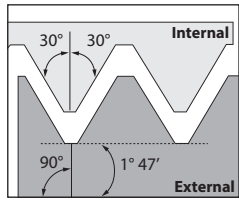

**NPT**  
Internal / External

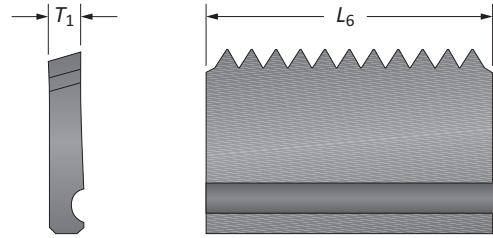

B  
BORING

TPI (Pitch)	Insert				Part No.
	L <sub>6</sub> inch	L <sub>6</sub> mm	T <sub>1</sub> inch	T <sub>1</sub> mm	NPT Internal/External
11.5	1.500	38.10	0.140	3.56	<b>TN150K-NPT11.5</b>
8	1.500	38.10	0.140	3.56	<b>TN150K-NPT8</b>

C  
REAMING

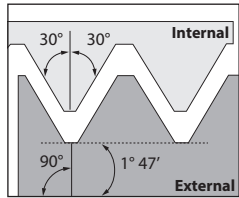

**NPTF**  
Internal / External

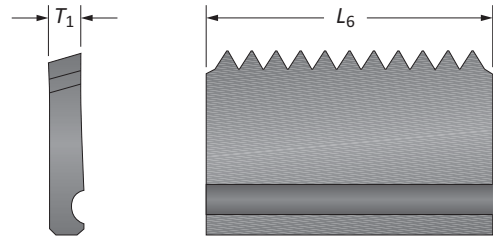

TPI (Pitch)	Insert				Part No.
	L <sub>6</sub> inch	L <sub>6</sub> mm	T <sub>1</sub> inch	T <sub>1</sub> mm	NPTF Internal/External
11.5	1.500	38.10	0.140	3.56	<b>TN150K-NPTF11.5</b>
8	1.500	38.10	0.140	3.56	<b>TN150K-NPTF8</b>

D  
BURNISHING

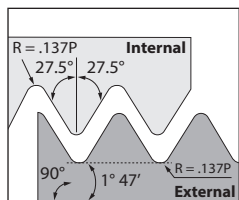

**BSPT**  
Internal / External

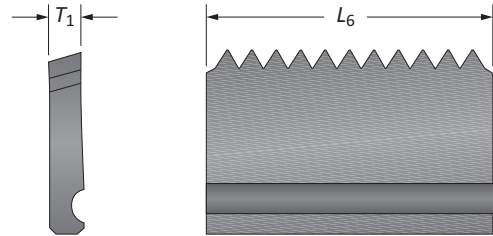

TPI (Pitch)	Insert				Part No.
	L <sub>6</sub> inch	L <sub>6</sub> mm	T <sub>1</sub> inch	T <sub>1</sub> mm	BSPT Internal/External
11	1.500	38.10	0.140	3.56	<b>TN150K-BSPT11</b>

E  
THREADING

X  
SPECIALS

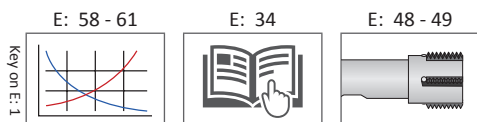

Inserts sold in quantities of 2



# AccuThread™ 856 Thread Mill Inserts

Pin Style | BSPP / API-ROUND / ACME

A

DRILLING

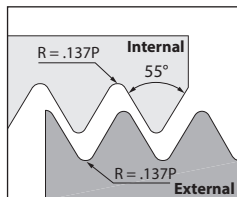

**BSPP**  
Internal / External

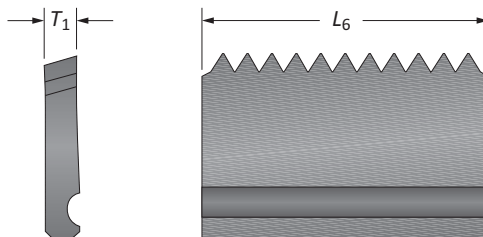

B

BORING

TPI (Pitch)	Insert				Part No.
	$L_6$ inch	$L_6$ mm	$T_1$ inch	$T_1$ mm	BSPP Internal/External
11	1.500	38.10	0.140	3.56	<b>TN150K-BSPP11</b>

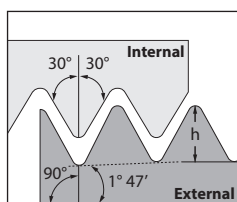

**API-ROUND**  
Internal / External

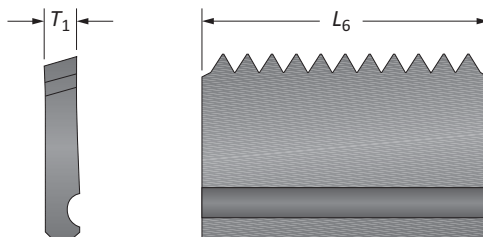

C

REAMING

TPI (Pitch)	Insert				Part No.
	$L_6$ inch	$L_6$ mm	$T_1$ inch	$T_1$ mm	API-ROUND Internal/External
10	1.500	38.10	0.140	3.56	<b>TN150K-AP10</b>
8	1.500	38.10	0.140	3.56	<b>TN150K-AP8</b>

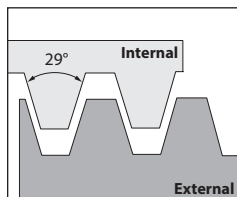

**ACME**  
Full Profile

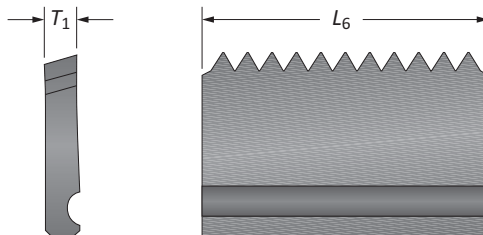

D

BURNISHING

TPI (Pitch)	Insert				Part No.
	$L_6$ inch	$L_6$ mm	$T_1$ inch	$T_1$ mm	ACME Full Profile
12	1.000	25.40	0.140	3.56	<b>TN100K-FA12</b>
12	1.500	38.10	0.140	3.56	<b>TN150K-FA12</b>
10	1.000	25.40	0.140	3.56	<b>TN100K-FA10</b>
10	1.500	38.10	0.140	3.56	<b>TN150K-FA10</b>
8	1.000	25.40	0.140	3.56	<b>TN100K-FA8</b>
8	1.500	38.10	0.140	3.56	<b>TN150K-FA8</b>
6	1.500	38.10	0.140	3.56	<b>TN150K-FA6</b>
5	1.500	38.10	0.140	3.56	<b>TN150K-FA5</b>

E

THREADING

X

SPECIALS

E: 58 - 61      E: 34      E: 48 - 49

Inserts sold in quantities of 2

## AccuThread™ 856 Thread Mill Inserts

Pin Style | UN

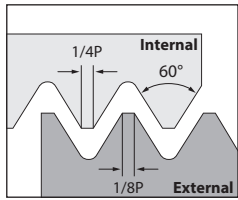

**UN**  
Internal

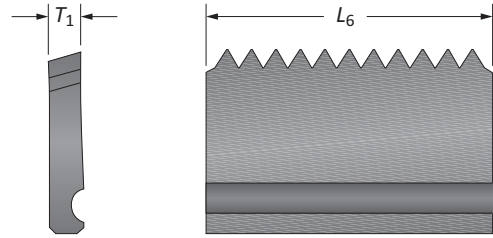

TPI (Pitch)	Insert				Part No.
	L <sub>6</sub> inch	L <sub>6</sub> mm	T <sub>1</sub> inch	T <sub>1</sub> mm	UN Internal
32	1.000	25.40	0.140	3.56	TN100K-UN32I
24	1.000	25.40	0.140	3.56	TN100K-UN24I
24	1.500	38.10	0.140	3.56	TN150K-UN24I
20	1.000	25.40	0.140	3.56	TN100K-UN20I
20	1.500	38.10	0.140	3.56	TN150K-UN20I
18	1.000	25.40	0.140	3.56	TN100K-UN18I
18	1.500	38.10	0.140	3.56	TN150K-UN18I
16	1.000	25.40	0.140	3.56	TN100K-UN16I
16	1.500	38.10	0.140	3.56	TN150K-UN16I
14	1.500	38.10	0.140	3.56	TN150K-UN14I
12	1.000	25.40	0.140	3.56	TN100K-UN12I
12	1.500	38.10	0.140	3.56	TN150K-UN12I
10	1.000	25.40	0.140	3.56	TN100K-UN10I
10	1.500	38.10	0.140	3.56	TN150K-UN10I
8	1.000	25.40	0.140	3.56	TN100K-UN8I
8	1.500	38.10	0.140	3.56	TN150K-UN8I
7	1.000	25.40	0.140	3.56	TN100K-UN7I
7	1.500	38.10	0.140	3.56	TN150K-UN7I
6	1.500	38.10	0.140	3.56	TN150K-UN6I

**D** BURNISHING

**F** THREADING

**X** SPECIALS

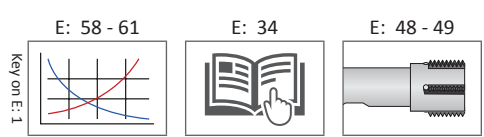

Inserts sold in quantities of 2



# AccuThread™ 856 Thread Mill Inserts

Pin Style | UN

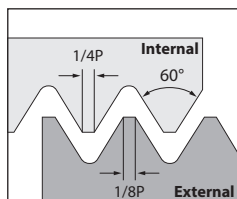

**UN**  
External

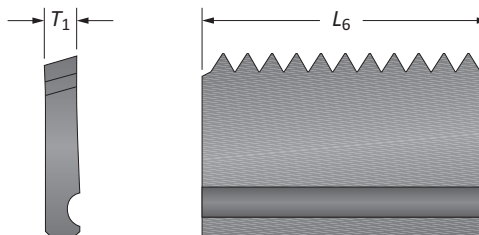

TPI (Pitch)	Insert				Part No.
	L <sub>6</sub> inch	L <sub>6</sub> mm	T <sub>1</sub> inch	T <sub>1</sub> mm	UN External
32	1.000	25.40	0.140	3.56	TN100K-UN32E
24	1.000	25.40	0.140	3.56	TN100K-UN24E
24	1.500	38.10	0.140	3.56	TN150K-UN24E
20	1.000	25.40	0.140	3.56	TN100K-UN20E
20	1.500	38.10	0.140	3.56	TN150K-UN20E
18	1.000	25.40	0.140	3.56	TN100K-UN18E
18	1.500	38.10	0.140	3.56	TN150K-UN18E
16	1.000	25.40	0.140	3.56	TN100K-UN16E
16	1.500	38.10	0.140	3.56	TN150K-UN16E
12	1.000	25.40	0.140	3.56	TN100K-UN12E
12	1.500	38.10	0.140	3.56	TN150K-UN12E
10	1.000	25.40	0.140	3.56	TN100K-UN10E
10	1.500	38.10	0.140	3.56	TN150K-UN10E
8	1.000	25.40	0.140	3.56	TN100K-UN8E
8	1.500	38.10	0.140	3.56	TN150K-UN8E
6	1.500	38.10	0.140	3.56	TN150K-UN6E

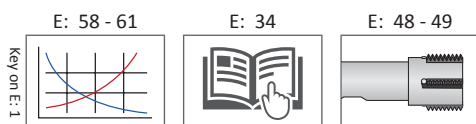

Inserts sold in quantities of 2

# AccuThread™ 856 Thread Mill Inserts

Pin Style | UNJ

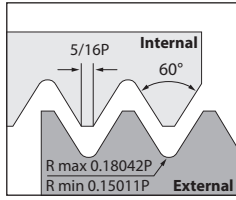

**UNJ**  
Internal

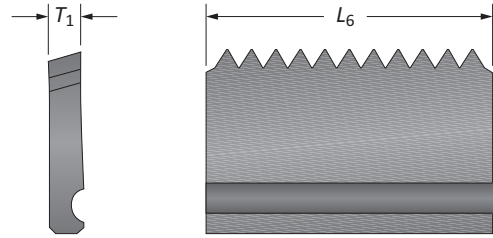

TPI (Pitch)	Insert				Part No.
	$L_6$ inch	$L_6$ mm	$T_1$ inch	$T_1$ mm	UNJ Internal
32	1.000	25.40	0.140	3.56	TN100K-UNJ32I
24	1.000	25.40	0.140	3.56	TN100K-UNJ24I
24	1.500	38.10	0.140	3.56	TN150K-UNJ24I
20	1.000	25.40	0.140	3.56	TN100K-UNJ20I
20	1.500	38.10	0.140	3.56	TN150K-UNJ20I
18	1.000	25.40	0.140	3.56	TN100K-UNJ18I
18	1.500	38.10	0.140	3.56	TN150K-UNJ18I
16	1.000	25.40	0.140	3.56	TN100K-UNJ16I
16	1.500	38.10	0.140	3.56	TN150K-UNJ16I
12	1.000	25.40	0.140	3.56	TN100K-UNJ12I
12	1.500	38.10	0.140	3.56	TN150K-UNJ12I
8	1.500	38.10	0.140	3.56	TN150K-UNJ8I

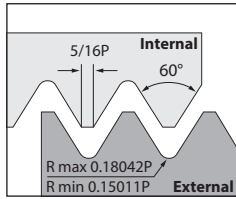

**UNJ**  
External

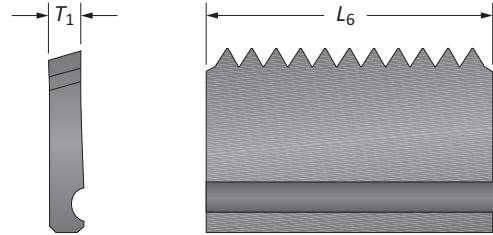

TPI (Pitch)	Insert				Part No.
	$L_6$ inch	$L_6$ mm	$T_1$ inch	$T_1$ mm	UNJ External
32	1.000	25.40	0.140	3.56	TN100K-UNJ32E
24	1.000	25.40	0.140	3.56	TN100K-UNJ24E
24	1.500	38.10	0.140	3.56	TN150K-UNJ24E
20	1.000	25.40	0.140	3.56	TN100K-UNJ20E
20	1.500	38.10	0.140	3.56	TN150K-UNJ20E
18	1.000	25.40	0.140	3.56	TN100K-UNJ18E
18	1.500	38.10	0.140	3.56	TN150K-UNJ18E
16	1.000	25.40	0.140	3.56	TN100K-UNJ16E
16	1.500	38.10	0.140	3.56	TN150K-UNJ16E
12	1.000	25.40	0.140	3.56	TN100K-UNJ12E
12	1.500	38.10	0.140	3.56	TN150K-UNJ12E
8	1.500	38.10	0.140	3.56	TN150K-UNJ8E

E: 58 - 61

E: 34

E: 48 - 49

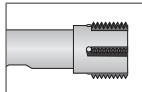
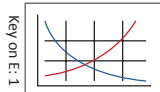

Inserts sold in quantities of 2



# AccuThread™ 856 Thread Mill Inserts

Pin Style | ISO

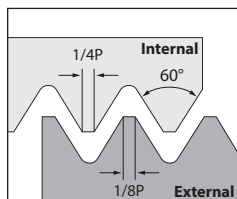

**ISO**  
Internal

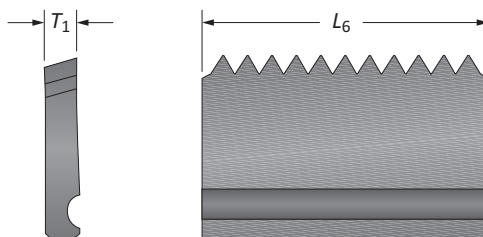

Pitch	Insert				Part No.
	L <sub>6</sub> inch	L <sub>6</sub> mm	T <sub>1</sub> inch	T <sub>1</sub> mm	ISO Internal
1.5	1.500	38.10	0.140	3.56	TN150K-M1.5I
2.0	1.500	38.10	0.140	3.56	TN150K-M2.0I
2.5	1.500	38.10	0.140	3.56	TN150K-M2.5I
3.0	1.500	38.10	0.140	3.56	TN150K-M3.0I
3.5	1.500	38.10	0.140	3.56	TN150K-M3.5I
4.0	1.500	38.10	0.140	3.56	TN150K-M4.0I
4.5	1.500	38.10	0.140	3.56	TN150K-M4.5I
5.0	1.500	38.10	0.140	3.56	TN150K-M5.0I
6.0	1.500	38.10	0.140	3.56	TN150K-M6.0I

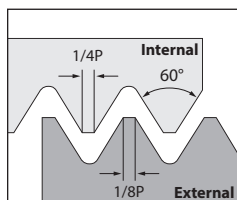

**ISO**  
External

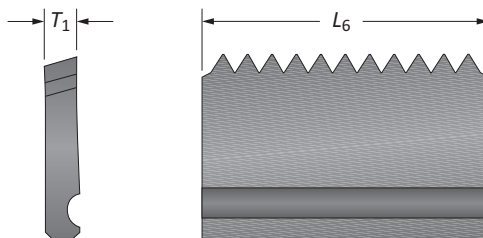

Pitch	Insert				Part No.
	L <sub>6</sub> inch	L <sub>6</sub> mm	T <sub>1</sub> inch	T <sub>1</sub> mm	ISO External
2.0	1.500	38.10	0.140	3.56	TN150K-M2.0E
4.0	1.500	38.10	0.140	3.56	TN150K-M4.0E
4.5	1.500	38.10	0.140	3.56	TN150K-M4.5E
5.0	1.500	38.10	0.140	3.56	TN150K-M5.0E
6.0	1.500	38.10	0.140	3.56	TN150K-M6.0E

A

DRILLING

B

BORING

C

REAMING

D

BURNISHING

E

THREADING

X

SPECIALS

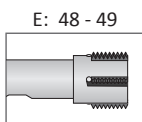
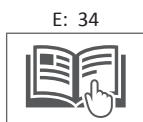
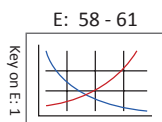

Key on E: 1

Inserts sold in quantities of 2

## AccuThread™ Pin Style Holders

Weldon Shank

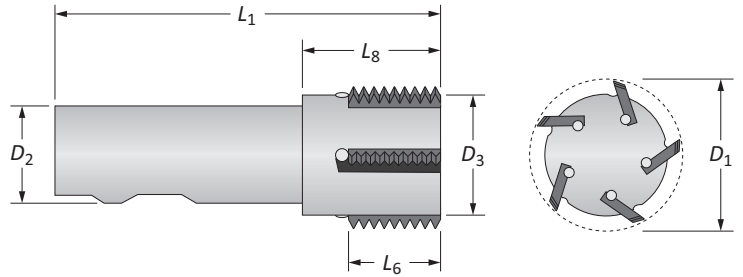
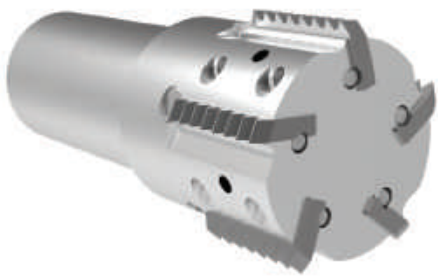

### Positive Rake

	D <sub>1</sub>		Holder					Coolant	Flutes	Part No.	Inserts	Screw	Key Size	Pin
	Standard	Oversize*	D <sub>3</sub>	L <sub>8</sub>	L <sub>6</sub>	L <sub>1</sub>	D <sub>2</sub>							
i	0.969	–	0.750	1.38	1.000	4.500	1.000	N	2	THP-0969-2F100	TN100K...	TMSS-3	3/32	TMP-1
	1.755	–	1.500	2.25	1.000	4.000	1.250	Y	5	THP-1755-5F100	TN100K...	TMSS-2	3/32	TMP-1
	0.932	1.063	0.722	1.90	1.500	4.500	1.000	N	1	THP-0932-1F150	TN150K...	TMSS-2	3/32	TMP-2
	0.969	1.100	0.750	2.00	1.500	4.500	1.000	N	2	THP-0969-2F150	TN150K...	TMSS-3	3/32	TMP-2
	1.116	1.247	0.812	2.00	1.500	4.500	1.000	Y	3	THP-1116-3F150	TN150K...	TMSS-3	3/32	TMP-2
	1.755	1.887	1.500	2.25	1.500	4.500	1.250	Y	5	THP-1755-5F150	TN150K...	TMSS-2	3/32	TMP-2
m	24.61	–	19.05	35.05	25.40	114.30	25.00	N	2	THP-0969-2F100M	TN100K...	TMSS-3	3/32	TMP-1
	44.58	–	38.10	57.15	25.40	101.60	32.00	Y	5	THP-1755-5F100M	TN100K...	TMSS-2	3/32	TMP-1
	23.67	27.00	18.34	48.44	38.10	114.30	25.00	N	1	THP-0932-1F150M	TN150K...	TMSS-2	3/32	TMP-2
	24.61	27.94	19.05	50.80	38.10	114.30	25.00	N	2	THP-0969-2F150M	TN150K...	TMSS-3	3/32	TMP-2
	28.35	31.67	20.63	50.80	38.10	114.30	25.00	Y	3	THP-1116-3F150M	TN150K...	TMSS-3	3/32	TMP-2
	44.58	47.93	38.10	57.15	38.10	114.30	32.00	Y	5	THP-1755-5F150M	TN150K...	TMSS-2	3/32	TMP-2

\*See note at bottom of page

### Neutral Rake

	D <sub>1</sub>		Holder					Coolant	Flutes	Part No.	Inserts	Screw	Key Size	Pin
	Standard	Oversize*	D <sub>3</sub>	L <sub>8</sub>	L <sub>6</sub>	L <sub>1</sub>	D <sub>2</sub>							
i	1.116	1.247	0.812	2.00	1.500	4.500	1.000	Y	3	TNR-1116-3F150	TN150K...	TMSS-3	3/32	TMP-2
	1.755	1.887	1.500	2.25	1.500	4.531	1.250	Y	5	TNR-1755-5F150	TN150K...	TMSS-2	3/32	TMP-2
m	28.35	31.67	20.63	50.80	38.10	114.30	25.00	Y	3	TNR-1116-3F150M	TN150K...	TMSS-3	3/32	TMP-2
	44.58	47.93	38.10	57.15	38.10	114.30	32.00	Y	5	TNR-1755-5F150M	TN150K...	TMSS-2	3/32	TMP-2

\*See note at bottom of page

\*Oversized cutter diameter occurs when assembled with the following pin style inserts:

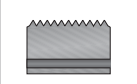
Key on E: 1	E: 34	E: 42 - 47	NPT 8	API 8	Metric 6.0	ACME 5
			NPTF 11.5		Metric 5.0	ACME 6
			NPTF 8		Metric 4.5	

i = Imperial (in)  
m = Metric (mm)





# AccuThread™ Pin Style Holders

## Shell Mill

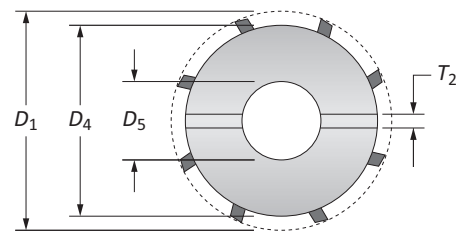
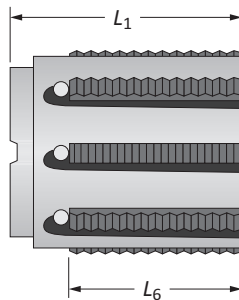

### Positive Rake

	D <sub>1</sub>		Holder					Flutes	Part No.	Inserts	Screw	Key Size	Pin
	Standard	Oversize*	D <sub>4</sub>	D <sub>5</sub>	L <sub>6</sub>	L <sub>1</sub>	T <sub>2</sub>						
i	2.714	2.845	2.500	1.000	1.500	2.250	0.375	7	<b>TSN-2846-7F150</b>	TN150K...	TMSS-2	3/32	TMP-2
	3.208	3.340	3.000	1.250	1.500	2.250	0.500	8	<b>TSN-3341-8F150</b>	TN150K...	TMSS-2	3/32	TMP-2
m	68.94	72.26	63.50	27.00	38.10	57.15	12	7	<b>TSN-2846-7F150M</b>	TN150K...	TMSS-2	3/32	TMP-2
	81.48	84.84	76.20	32.00	38.10	57.15	14	8	<b>TSN-3341-8F150M</b>	TN150K...	TMSS-2	3/32	TMP-2

\*See note at bottom of page

### Neutral Rake

	D <sub>1</sub>		Holder					Flutes	Part No.	Inserts	Screw	Key Size	Pin
	Standard	Oversize*	D <sub>4</sub>	D <sub>5</sub>	L <sub>6</sub>	L <sub>1</sub>	T <sub>2</sub>						
i	2.217	2.349	2.000	0.750	1.500	2.250	0.312	6	<b>TSR-2217-6F150</b>	TN150K...	TMSS-2	3/32	TMP-2
m	56.31	59.66	50.80	22.00	38.10	57.15	10.00	6	<b>TSR-2217-6F150M</b>	TN150K...	TMSS-2	3/32	TMP-2

\*See note at bottom of page

E: 34

E: 42 - 47

\*Oversized cutter diameter occurs when assembled with the following pin style inserts:

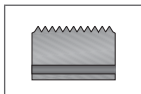

NPT 8  
NPTF 11.5  
NPTF 8

API 8

Metric 6.0  
Metric 5.0  
Metric 4.5

ACME 5  
ACME 6

i = Imperial (in)  
m = Metric (mm)

## Thread Mill Pre-Drill Information

### Linear Feed Rate (LFR)

$$LFR = RPM \cdot (IPT \cdot \text{Number of flutes})$$

RPM = Revolutions per minute

IPT = Recommended feed (inch / tooth)

### Surface Feet per Minute (SFM)

$$SFM = RPM \cdot 0.262 \cdot \text{Diameter}$$

RPM = Revolutions per minute

### Revolutions per Minute (RPM)

$$RPM = \frac{SFM \cdot 3.82}{\text{Diameter}}$$

SFM = Surface feet per minute

### Adjusted Feed Rate (AFR) - For Internal Threading

$$AFR = \frac{\text{Major Diameter} - \text{Cutter Diameter}}{\text{Major Diameter}} [LFR]$$

LFR = Linear feed rate

**NOTICE:** The above formula on an internal thread program adjusts the linear feed rate to be applied to the outer diameter instead of the center of the cutting tool. If the feed rate is not adjusted, the excessive feed rate will cause the thread mill cutting edges to fail.

### Example of an Internal Adjusted Feed Rate Calculation:

Cast iron 125 BHN with a 1/2-13 thread form using AccuThread 856 solid carbide (TMUK0500-13)

STEP 1:

$$RPM = \frac{SFM \cdot 3.82}{\text{Diameter}}$$

$$RPM = \frac{675 \cdot 3.82}{0.350}$$

$$RPM = 7367$$

STEP 2:

$$LFR = RPM \cdot (IPT \cdot \text{Number of flutes})$$

$$LFR = 7367 \cdot (0.0010 \cdot 4)$$

$$LFR = 29.47 \text{ IPM}$$

STEP 3:

$$AFR = \frac{\text{Major Diameter} - \text{Cutter Diameter}}{\text{Major Diameter}} [LFR]$$

$$AFR = \frac{0.500 - 0.350}{0.500} [29.47]$$

$$AFR = 8.84 \text{ IPM}$$

## Thread Mill Calculations and Recommended Passes

### Thread Mill Drill Calculation

Based on nominal tap drill diameter. Based on 0.003" or 0.075mm probable mean oversize.

To calculate the percent of full thread for a given hole diameter:

**IMPERIAL:** % of thread = # of threads per inch •  $\frac{\text{Basic major diameter of thread} - \text{Drill hole size}}{0.0130}$

**METRIC:** % of thread =  $\frac{76.96}{\text{Pitch (mm)}}$  • [ Basic major diameter of thread - Drill hole size ]

### Major Thread Diameter for # Drills

Drill #	Thread Diameter
# 2	0.086
# 3	0.099
# 4	0.112
# 5	0.125
# 6	0.132
# 8	0.164
# 10	0.190
# 12	0.216

### Recommended Passes

Pitch Size	Machinability		
	Easy	Average	Difficult
28	1	1	2
27	1	1	2
19	1	1	2
18	1	1	2
14	1	2	3
11.5	1	2	3
11	1	2	3
10	1	2	3
8	2	3	4

- 1 Pass
- 2 Passes
- 3 Passes
- 4 Passes

Pitch Size	Machinability		
	Easy	Average	Difficult
0.40	1	1	2
0.45	1	1	2
0.50	1	1	2
0.70	1	1	2
0.75	1	1	2
0.80	1	1	2
1.00	1	1	2
1.25	1	2	3
1.50	1	2	3
1.75	1	2	3
2.00	1	2	3
2.50	2	3	4
3.00	2	3	4
3.50	2	3	4
4.00	2	3	4
4.50	2	3	4
5.00	2	3	4
6.00	2	3	4

Pitch Size	Machinability		
	Easy	Average	Difficult
64	1	1	2
56	1	1	2
48	1	1	2
44	1	1	2
40	1	1	2
36	1	1	2
32	1	1	2
28	1	1	2
24	1	1	2
20	1	2	3
19	1	2	3
18	1	2	3
16	1	2	3
14	1	2	3
13	1	2	3
12	1	2	3
11	2	2	4
10	2	3	4
9	2	3	4
8	2	3	4
7	2	3	4
6	2	3	4

## Recommended Cutting Data | Imperial (inch)

Solid Carbide | AccuThread™ 856

ISO	Material	Hardness (BHN)	Machinability*	Speed (SFM)	Recommended Feed (inch/tooth) by Cutter Diameter							
					0.060 to 0.125	0.126 to 0.188	0.189 to 0.250	0.251 to 0.312	0.313 to 0.375	0.376 to 0.500	0.501 to 0.625	0.626 to 0.750
P	Free Machining Steel 1118, 1215, 12L14, etc.	100 - 150	Easy	900	0.0004	0.0005	0.0007	0.0009	0.0010	0.0015	0.0020	0.0025
		150 - 200	Easy	700	0.0004	0.0005	0.0007	0.0009	0.0010	0.0015	0.0020	0.0025
		200 - 250	Easy	500	0.0004	0.0005	0.0007	0.0009	0.0010	0.0015	0.0020	0.0025
	Low Carbon Steel 1010, 1020, 1025, 1522, 1144	85 - 125	Average	900	0.0004	0.0005	0.0007	0.0009	0.0010	0.0015	0.0020	0.0025
		125 - 175	Average	700	0.0004	0.0005	0.0007	0.0009	0.0010	0.0015	0.0020	0.0025
		175 - 225	Average	600	0.0004	0.0005	0.0007	0.0009	0.0010	0.0015	0.0020	0.0025
		225 - 275	Average	500	0.0004	0.0005	0.0007	0.0009	0.0010	0.0015	0.0020	0.0025
	Medium Carbon Steel 1010, 1040, 1050, 1527, 1140	125 - 175	Average	575	0.0004	0.0005	0.0006	0.0008	0.0010	0.0013	0.0018	0.0020
		175 - 225	Average	500	0.0004	0.0005	0.0006	0.0008	0.0010	0.0013	0.0018	0.0020
		225 - 275	Average	450	0.0004	0.0005	0.0006	0.0008	0.0010	0.0013	0.0018	0.0020
		275 - 325	Average	400	0.0004	0.0005	0.0006	0.0008	0.0010	0.0013	0.0018	0.0020
	Alloy Steel 4140, 5140, 8640	125 - 175	Average	575	0.0004	0.0005	0.0006	0.0008	0.0010	0.0013	0.0018	0.0020
		175 - 225	Average	500	0.0004	0.0005	0.0006	0.0008	0.0010	0.0013	0.0018	0.0020
		225 - 275	Average	450	0.0004	0.0005	0.0006	0.0008	0.0010	0.0013	0.0018	0.0020
		275 - 325	Difficult	400	0.0004	0.0005	0.0006	0.0008	0.0010	0.0013	0.0018	0.0020
		325 - 375	Difficult	375	0.0004	0.0005	0.0006	0.0008	0.0010	0.0013	0.0018	0.0020
	High Strength Alloy 4340, 4330V, 300M	225 - 300	Average	450	0.0004	0.0005	0.0006	0.0008	0.0010	0.0013	0.0018	0.0020
		300 - 350	Difficult	400	0.0004	0.0005	0.0006	0.0008	0.0010	0.0013	0.0018	0.0020
350 - 400		Difficult	350	0.0004	0.0005	0.0006	0.0008	0.0010	0.0013	0.0018	0.0020	
Structural Steel A36, A285, A516	100 - 150	Average	600	0.0004	0.0005	0.0007	0.0009	0.0010	0.0015	0.0020	0.0025	
	150 - 250	Average	500	0.0004	0.0005	0.0007	0.0009	0.0010	0.0015	0.0020	0.0025	
	250 - 350	Difficult	450	0.0004	0.0005	0.0007	0.0009	0.0010	0.0015	0.0020	0.0025	
S	High Temp Alloy Hastelloy B, Inconel 600	140 - 220	Difficult	120	0.0003	0.0004	0.0006	0.0008	0.0009	0.0010	0.0012	0.0015
		220 - 310	Difficult	90	0.0003	0.0004	0.0006	0.0008	0.0009	0.0010	0.0012	0.0015
M	Stainless Steel 303, 416, 420	135 - 185	Difficult	525	0.0004	0.0005	0.0006	0.0008	0.0009	0.0010	0.0015	0.0020
		185 - 275	Difficult	500	0.0004	0.0005	0.0006	0.0008	0.0009	0.0010	0.0015	0.0020
	Stainless Steel PH 17-4	185 - 275	Difficult	300	0.0004	0.0005	0.0006	0.0008	0.0009	0.0010	0.0015	0.0020
		275 - 325	Difficult	150	0.0004	0.0005	0.0006	0.0008	0.0009	0.0010	0.0015	0.0020
	Tool Steel H-13, H21, A-4	150 - 200	Difficult	575	0.0004	0.0005	0.0007	0.0009	0.0010	0.0015	0.0020	0.0025
200 - 250		Difficult	500	0.0004	0.0005	0.0007	0.0009	0.0010	0.0015	0.0020	0.0025	
K	Cast Iron Grey, Ductile, Nodular	120 - 150	Easy	675	0.0004	0.0005	0.0007	0.0009	0.0010	0.0015	0.0020	0.0025
		150 - 200	Easy	625	0.0004	0.0005	0.0007	0.0009	0.0010	0.0015	0.0020	0.0025
		200 - 220	Easy	575	0.0004	0.0005	0.0007	0.0009	0.0010	0.0015	0.0020	0.0025
		220 - 260	Average	500	0.0004	0.0005	0.0007	0.0009	0.0010	0.0015	0.0020	0.0025
		260 - 320	Average	475	0.0004	0.0005	0.0007	0.0009	0.0010	0.0015	0.0020	0.0025
N	Wrought Aluminum 6061 T6	30	Easy	1100	0.0005	0.0006	0.0009	0.0010	0.0015	0.0020	0.0025	0.0030
		180	Easy	1000	0.0005	0.0006	0.0009	0.0010	0.0015	0.0020	0.0025	0.0030
	Cast Aluminum** up to 10% silicon	120	Easy	625	0.0005	0.0006	0.0009	0.0010	0.0015	0.0020	0.0025	0.0030
	Brass	30 - 125	Easy	1100	0.0005	0.0006	0.0009	0.0010	0.0015	0.0020	0.0025	0.0030

**NOTICE:** Reduce feed and speed by 30% for tapered thread forms due to additional material removal

\*Refer to recommended pass chart on page E: 45 when referencing material machinability

\*\*Uncoated thread mills are recommended for cast aluminum applications

## Recommended Cutting Data | Metric (mm)

Solid Carbide | AccuThread™ 856

ISO	Material	Hardness (BHN)	Machinability*	Speed (M/min)	Recommended Feed (mm/tooth) by Cutter Diameter							
					1.50 to 3.18	3.19 to 4.76	4.77 to 6.35	6.36 to 7.94	7.95 to 9.53	9.54 to 12.70	12.71 to 15.88	15.89 to 19.05
P	Free Machining Steel 1118, 1215, 12L14, etc.	100 - 150	Easy	274	0.010	0.013	0.018	0.023	0.025	0.038	0.051	0.064
		150 - 200	Easy	213	0.010	0.013	0.018	0.023	0.025	0.038	0.051	0.064
		200 - 250	Easy	152	0.010	0.013	0.018	0.023	0.025	0.038	0.051	0.064
	Low Carbon Steel 1010, 1020, 1025, 1522, 1144	85 - 125	Average	274	0.010	0.013	0.018	0.023	0.025	0.038	0.051	0.064
		125 - 175	Average	213	0.010	0.013	0.018	0.023	0.025	0.038	0.051	0.064
		175 - 225	Average	183	0.010	0.013	0.018	0.023	0.025	0.038	0.051	0.064
	Medium Carbon Steel 1010, 1040, 1050, 1527, 1140	225 - 275	Average	152	0.010	0.013	0.018	0.023	0.025	0.038	0.051	0.064
		125 - 175	Average	175	0.010	0.013	0.015	0.020	0.025	0.033	0.046	0.051
		175 - 225	Average	152	0.010	0.013	0.015	0.020	0.025	0.033	0.046	0.051
		225 - 275	Average	137	0.010	0.013	0.015	0.020	0.025	0.033	0.046	0.051
	Alloy Steel 4140, 5140, 8640	275 - 325	Average	122	0.010	0.013	0.015	0.020	0.025	0.033	0.046	0.051
		125 - 175	Average	175	0.010	0.013	0.015	0.020	0.025	0.033	0.046	0.051
		175 - 225	Average	152	0.010	0.013	0.015	0.020	0.025	0.033	0.046	0.051
		225 - 275	Average	137	0.010	0.013	0.015	0.020	0.025	0.033	0.046	0.051
	High Strength Alloy 4340, 4330V, 300M	275 - 325	Difficult	122	0.010	0.013	0.015	0.020	0.025	0.033	0.046	0.051
		325 - 375	Difficult	114	0.010	0.013	0.015	0.020	0.025	0.033	0.046	0.051
		225 - 300	Average	137	0.010	0.013	0.015	0.020	0.025	0.033	0.046	0.051
	Structural Steel A36, A285, A516	300 - 350	Difficult	122	0.010	0.013	0.015	0.020	0.025	0.033	0.046	0.051
350 - 400		Difficult	107	0.010	0.013	0.015	0.020	0.025	0.033	0.046	0.051	
S	High Temp Alloy Hastelloy B, Inconel 600	100 - 150	Average	183	0.010	0.013	0.018	0.023	0.025	0.038	0.051	0.064
		150 - 250	Average	152	0.010	0.013	0.018	0.023	0.025	0.038	0.051	0.064
		250 - 350	Difficult	137	0.010	0.013	0.018	0.023	0.025	0.038	0.051	0.064
		140 - 220	Difficult	37	0.008	0.010	0.015	0.020	0.023	0.025	0.030	0.038
		220 - 310	Difficult	27	0.008	0.010	0.015	0.020	0.023	0.025	0.030	0.038
		M	Stainless Steel 303, 416, 420	135 - 185	Difficult	160	0.010	0.013	0.015	0.020	0.023	0.025
185 - 275	Difficult			152	0.010	0.013	0.015	0.020	0.023	0.025	0.038	0.051
Stainless Steel PH 17-4	185 - 275		Difficult	91	0.010	0.013	0.015	0.020	0.023	0.025	0.038	0.051
	275 - 325		Difficult	46	0.010	0.013	0.015	0.020	0.023	0.025	0.038	0.051
Tool Steel H-13, H21, A-4	150 - 200	Difficult	175	0.010	0.013	0.018	0.023	0.025	0.038	0.051	0.064	
	200 - 250	Difficult	152	0.010	0.013	0.018	0.023	0.025	0.038	0.051	0.064	
K	Cast Iron Grey, Ductile, Nodular	120 - 150	Easy	206	0.010	0.013	0.018	0.023	0.025	0.038	0.051	0.064
		150 - 200	Easy	191	0.010	0.013	0.018	0.023	0.025	0.038	0.051	0.064
		200 - 220	Easy	175	0.010	0.013	0.018	0.023	0.025	0.038	0.051	0.064
		220 - 260	Average	152	0.010	0.013	0.018	0.023	0.025	0.038	0.051	0.064
		260 - 320	Average	145	0.010	0.013	0.018	0.023	0.025	0.038	0.051	0.064
N	Wrought Aluminum 6061 T6	30	Easy	335	0.013	0.015	0.023	0.025	0.038	0.051	0.064	0.076
		180	Easy	305	0.013	0.015	0.023	0.025	0.038	0.051	0.064	0.076
	Cast Aluminum** up to 10% silicon	120	Easy	191	0.013	0.015	0.023	0.025	0.038	0.051	0.064	0.076
	Brass	30 - 125	Easy	335	0.013	0.015	0.023	0.025	0.038	0.051	0.064	0.076

**NOTICE:** Reduce feed and speed by 30% for tapered thread forms due to additional material removal

\*Refer to recommended pass chart on page E: 45 when referencing material machinability

\*\*Uncoated thread mills are recommended for cast aluminum applications

A DRILLING  
B BORING  
C REAMING  
D BURNISHING  
E THREADING  
X SPECIALS

## Recommended Cutting Data | Imperial (inch)

Solid Carbide | ThreadMills USA

ISO	Material	Hardness (BHN)	Machinability*	Speed (SFM)	Recommended Feed (inch/tooth) by Cutter Diameter							
					0.060 to 0.125	0.126 to 0.188	0.189 to 0.250	0.251 to 0.312	0.313 to 0.375	0.376 to 0.500	0.501 to 0.625	0.626 to 0.750
P	Free Machining Steel 1118, 1215, 12L14, etc.	100 - 150	Easy	725	0.0004	0.0005	0.0007	0.0009	0.0010	0.0015	0.0020	0.0025
		150 - 200	Easy	550	0.0004	0.0005	0.0007	0.0009	0.0010	0.0015	0.0020	0.0025
		200 - 250	Easy	450	0.0004	0.0005	0.0007	0.0009	0.0010	0.0015	0.0020	0.0025
	Low Carbon Steel 1010, 1020, 1025, 1522, 1144	85 - 125	Average	725	0.0004	0.0005	0.0007	0.0009	0.0010	0.0015	0.0020	0.0025
		125 - 175	Average	550	0.0004	0.0005	0.0007	0.0009	0.0010	0.0015	0.0020	0.0025
		175 - 225	Average	450	0.0004	0.0005	0.0007	0.0009	0.0010	0.0015	0.0020	0.0025
		225 - 275	Average	400	0.0004	0.0005	0.0007	0.0009	0.0010	0.0015	0.0020	0.0025
	Medium Carbon Steel 1010, 1040, 1050, 1527, 1140	125 - 175	Average	450	0.0004	0.0005	0.0006	0.0008	0.0010	0.0013	0.0018	0.0020
		175 - 225	Average	400	0.0004	0.0005	0.0006	0.0008	0.0010	0.0013	0.0018	0.0020
		225 - 275	Average	350	0.0004	0.0005	0.0006	0.0008	0.0010	0.0013	0.0018	0.0020
		275 - 325	Average	300	0.0004	0.0005	0.0006	0.0008	0.0010	0.0013	0.0018	0.0020
	Alloy Steel 4140, 5140, 8640	125 - 175	Average	450	0.0004	0.0005	0.0006	0.0008	0.0010	0.0013	0.0018	0.0020
		175 - 225	Average	400	0.0004	0.0005	0.0006	0.0008	0.0010	0.0013	0.0018	0.0020
		225 - 275	Average	350	0.0004	0.0005	0.0006	0.0008	0.0010	0.0013	0.0018	0.0020
		275 - 325	Difficult	300	0.0004	0.0005	0.0006	0.0008	0.0010	0.0013	0.0018	0.0020
		325 - 375	Difficult	250	0.0004	0.0005	0.0006	0.0008	0.0010	0.0013	0.0018	0.0020
	High Strength Alloy 4340, 4330V, 300M	225 - 300	Average	350	0.0004	0.0005	0.0006	0.0008	0.0010	0.0013	0.0018	0.0020
		300 - 350	Difficult	300	0.0004	0.0005	0.0006	0.0008	0.0010	0.0013	0.0018	0.0020
350 - 400		Difficult	250	0.0004	0.0005	0.0006	0.0008	0.0010	0.0013	0.0018	0.0020	
Structural Steel A36, A285, A516	100 - 150	Average	450	0.0004	0.0005	0.0007	0.0009	0.0010	0.0015	0.0020	0.0025	
	150 - 250	Average	400	0.0004	0.0005	0.0007	0.0009	0.0010	0.0015	0.0020	0.0025	
	250 - 350	Difficult	300	0.0004	0.0005	0.0007	0.0009	0.0010	0.0015	0.0020	0.0025	
S	High Temp Alloy Hastelloy B, Inconel 600	140 - 220	Difficult	100	0.0003	0.0004	0.0006	0.0008	0.0009	0.0010	0.0012	0.0015
		220 - 310	Difficult	75	0.0003	0.0004	0.0006	0.0008	0.0009	0.0010	0.0012	0.0015
M	Stainless Steel 303, 416, 420	135 - 185	Difficult	425	0.0004	0.0005	0.0006	0.0008	0.0009	0.0010	0.0015	0.0020
		185 - 275	Difficult	400	0.0004	0.0005	0.0006	0.0008	0.0009	0.0010	0.0015	0.0020
	Stainless Steel PH 17-4	185 - 275	Difficult	250	0.0004	0.0005	0.0006	0.0008	0.0009	0.0010	0.0015	0.0020
		275 - 325	Difficult	125	0.0004	0.0005	0.0006	0.0008	0.0009	0.0010	0.0015	0.0020
	Tool Steel H-13, H21, A-4	150 - 200	Difficult	325	0.0004	0.0005	0.0007	0.0008	0.0010	0.0015	0.0020	0.0025
200 - 250		Difficult	225	0.0004	0.0005	0.0007	0.0008	0.0010	0.0015	0.0020	0.0025	
K	Cast Iron Grey, Ductile, Nodular	120 - 150	Easy	550	0.0004	0.0005	0.0007	0.0009	0.0010	0.0015	0.0020	0.0025
		150 - 200	Easy	500	0.0004	0.0005	0.0007	0.0009	0.0010	0.0015	0.0020	0.0025
		200 - 220	Easy	450	0.0004	0.0005	0.0007	0.0009	0.0010	0.0015	0.0020	0.0025
		220 - 260	Average	400	0.0004	0.0005	0.0007	0.0009	0.0010	0.0015	0.0020	0.0025
		260 - 320	Average	375	0.0004	0.0005	0.0007	0.0009	0.0010	0.0015	0.0020	0.0025
N	Wrought Aluminum 6061 T6	30	Easy	1000	0.0005	0.0006	0.0009	0.0010	0.0015	0.0020	0.0025	0.0030
		180	Easy	900	0.0005	0.0006	0.0009	0.0010	0.0015	0.0020	0.0025	0.0030
	Cast Aluminum** up to 10% silicon	120	Easy	500	0.0005	0.0006	0.0009	0.0010	0.0015	0.0020	0.0025	0.0030
	Brass	30 - 125	Easy	1000	0.0005	0.0006	0.0009	0.0010	0.0015	0.0020	0.0025	0.0030

**NOTICE:** Reduce feed and speed by 30% for tapered thread forms due to additional material removal

\*Refer to recommended pass chart on page E: 45 when referencing material machinability

\*\*Uncoated thread mills are recommended for cast aluminum applications

## Recommended Cutting Data | Metric (mm)

Solid Carbide | ThreadMills USA

ISO	Material	Hardness (BHN)	Machinability*	Speed (M/min)	Recommended Feed (mm/tooth) by Cutter Diameter							
					1.50 to 3.18	3.19 to 4.76	4.77 to 6.35	6.36 to 7.94	7.95 to 9.53	9.54 to 12.70	12.71 to 15.88	15.89 to 19.05
P	Free Machining Steel 1118, 1215, 12L14, etc.	100 - 150	Easy	221	0.010	0.013	0.018	0.023	0.025	0.038	0.051	0.064
		150 - 200	Easy	168	0.010	0.013	0.018	0.023	0.025	0.038	0.051	0.064
		200 - 250	Easy	137	0.010	0.013	0.018	0.023	0.025	0.038	0.051	0.064
	Low Carbon Steel 1010, 1020, 1025, 1522, 1144	85 - 125	Average	221	0.010	0.013	0.018	0.023	0.025	0.038	0.051	0.064
		125 - 175	Average	168	0.010	0.013	0.018	0.023	0.025	0.038	0.051	0.064
		175 - 225	Average	137	0.010	0.013	0.018	0.023	0.025	0.038	0.051	0.064
	Medium Carbon Steel 1010, 1040, 1050, 1527, 1140	225 - 275	Average	122	0.010	0.013	0.018	0.023	0.025	0.038	0.051	0.064
		125 - 175	Average	137	0.010	0.013	0.015	0.020	0.025	0.038	0.046	0.051
		175 - 225	Average	122	0.010	0.013	0.015	0.020	0.025	0.038	0.046	0.051
	Alloy Steel 4140, 5140, 8640	225 - 275	Average	107	0.010	0.013	0.015	0.020	0.025	0.038	0.046	0.051
		275 - 325	Average	91	0.010	0.013	0.015	0.020	0.025	0.038	0.046	0.051
		275 - 325	Difficult	91	0.010	0.013	0.015	0.020	0.025	0.038	0.046	0.051
		325 - 375	Difficult	76	0.010	0.013	0.015	0.020	0.025	0.038	0.046	0.051
	High Strength Alloy 4340, 4330V, 300M	225 - 300	Average	107	0.010	0.013	0.015	0.020	0.025	0.038	0.046	0.051
		300 - 350	Difficult	91	0.010	0.013	0.015	0.020	0.025	0.038	0.046	0.051
		350 - 400	Difficult	76	0.010	0.013	0.015	0.020	0.025	0.038	0.046	0.051
	Structural Steel A36, A285, A516	100 - 150	Average	137	0.010	0.013	0.018	0.023	0.025	0.038	0.051	0.064
		150 - 250	Average	122	0.010	0.013	0.018	0.023	0.025	0.038	0.051	0.064
250 - 350		Difficult	91	0.010	0.013	0.018	0.023	0.025	0.038	0.051	0.064	
S	High Temp Alloy Hastelloy B, Inconel 600	140 - 220	Difficult	30	0.008	0.010	0.015	0.020	0.023	0.025	0.030	0.038
		220 - 310	Difficult	23	0.008	0.010	0.015	0.020	0.023	0.025	0.030	0.038
M	Stainless Steel 303, 416, 420	135 - 185	Difficult	130	0.010	0.013	0.015	0.020	0.023	0.025	0.038	0.051
		185 - 275	Difficult	122	0.010	0.013	0.015	0.020	0.023	0.025	0.038	0.051
	Stainless Steel PH 17-4	185 - 275	Difficult	76	0.010	0.013	0.015	0.020	0.023	0.025	0.038	0.051
		275 - 325	Difficult	38	0.010	0.013	0.015	0.020	0.023	0.025	0.038	0.051
Tool Steel H-13, H21, A-4	150 - 200	Difficult	99	0.010	0.013	0.018	0.023	0.025	0.038	0.051	0.064	
	200 - 250	Difficult	69	0.010	0.013	0.018	0.023	0.025	0.038	0.051	0.064	
R	Cast Iron Grey, Ductile, Nodular	120 - 150	Easy	168	0.010	0.013	0.018	0.023	0.025	0.038	0.051	0.064
		150 - 200	Easy	152	0.010	0.013	0.018	0.023	0.025	0.038	0.051	0.064
		200 - 220	Easy	137	0.010	0.013	0.018	0.023	0.025	0.038	0.051	0.064
		220 - 260	Average	122	0.010	0.013	0.018	0.023	0.025	0.038	0.051	0.064
		260 - 320	Average	114	0.010	0.013	0.018	0.023	0.025	0.038	0.051	0.064
S	Wrought Aluminum 6061 T6	30	Easy	305	0.013	0.015	0.023	0.025	0.038	0.051	0.064	0.076
		180	Easy	274	0.013	0.015	0.023	0.025	0.038	0.051	0.064	0.076
	Cast Aluminum** up to 10% silicon	120	Easy	152	0.013	0.015	0.023	0.025	0.038	0.051	0.064	0.076
	Brass	30 - 125	Easy	305	0.013	0.015	0.023	0.025	0.038	0.051	0.064	0.076

**NOTICE:** Reduce feed and speed by 30% for tapered thread forms due to additional material removal

\*Refer to recommended pass chart on page E: 45 when referencing material machinability

\*\*Uncoated thread mills are recommended for cast aluminum applications

A DRILLING  
B BORING  
C REAMING  
D BURNISHING  
E THREADING  
X SPECIALS

## Recommended Cutting Data | Imperial (inch)

Solid Carbide | AccuThread™ T3

ISO	Material	Hardness (BHN)	Speed (SFM)	Chipload per Tooth (IPT) by Cutter Diameter					
				0.055 to 0.125	0.126 to 0.188	0.189 to 0.250	0.251 to 0.312	0.313 to 0.375	0.376 to 0.500
P	Free Machining Steel 1118, 1215, 12L14, etc.	100 - 150	375	0.0008	0.0010	0.0014	0.0018	0.0020	0.0030
		150 - 200	275	0.0008	0.0010	0.0014	0.0018	0.0020	0.0030
		200 - 250	225	0.0008	0.0010	0.0014	0.0018	0.0020	0.0030
	Low Carbon Steel 1010, 1020, 1025, 1522, 1144, etc.	85 - 125	375	0.0008	0.0010	0.0014	0.0018	0.0020	0.0030
		125 - 175	275	0.0008	0.0010	0.0014	0.0018	0.0020	0.0030
		175 - 225	225	0.0008	0.0010	0.0014	0.0018	0.0020	0.0030
	Medium Carbon Steel 1030, 1040, 1050, 1527, 1140, 1151, etc.	125 - 175	225	0.0008	0.0010	0.0012	0.0016	0.0020	0.0026
		175 - 225	200	0.0008	0.0010	0.0012	0.0016	0.0020	0.0026
		225 - 275	175	0.0008	0.0010	0.0012	0.0016	0.0020	0.0026
		275 - 325	150	0.0008	0.0010	0.0012	0.0016	0.0020	0.0026
	Alloy Steel 4140, 5140, 8640, etc.	125 - 175	225	0.0008	0.0010	0.0012	0.0016	0.0020	0.0026
		175 - 225	200	0.0008	0.0010	0.0012	0.0016	0.0020	0.0026
225 - 275		175	0.0008	0.0010	0.0012	0.0016	0.0020	0.0026	
275 - 325		150	0.0008	0.0010	0.0012	0.0016	0.0020	0.0026	
High Strength Alloy 4340, 4330V, 300M, etc.	225 - 300	175	0.0008	0.0010	0.0012	0.0016	0.0020	0.0026	
	300 - 350	150	0.0008	0.0010	0.0012	0.0016	0.0020	0.0026	
	350 - 400	125	0.0008	0.0010	0.0012	0.0016	0.0020	0.0026	
Structural Steel A36, A285, A516, etc.	100 - 150	225	0.0008	0.0010	0.0014	0.0018	0.0020	0.0030	
	150 - 250	200	0.0008	0.0010	0.0014	0.0018	0.0020	0.0030	
	250 - 350	150	0.0008	0.0010	0.0014	0.0018	0.0020	0.0030	
Tool Steel H-13, H-21, A-4, O-2, S-3, etc.	150 - 200	175	0.0008	0.0010	0.0012	0.0016	0.0020	0.0026	
	200 - 250	125	0.0008	0.0010	0.0012	0.0016	0.0020	0.0026	
S	High Temp Alloy Hastelloy B, Inconel 600, etc.	140 - 220	100	0.0006	0.0008	0.0012	0.0016	0.0018	0.0020
		220 - 310	75	0.0006	0.0008	0.0012	0.0016	0.0018	0.0020
	Titanium Alloy	140 - 220	100	0.0006	0.0008	0.0012	0.0016	0.0018	0.0020
		220 - 310	75	0.0006	0.0008	0.0012	0.0016	0.0018	0.0020
Aerospace Alloy S82	185 - 275	100	0.0006	0.0008	0.0012	0.0016	0.0018	0.0020	
	275 - 350	75	0.0006	0.0008	0.0012	0.0016	0.0018	0.0020	
M	Stainless Steel 416, 420, etc.	185 - 275	225	0.0008	0.0010	0.0012	0.0016	0.0018	0.0020
		275 - 350	200	0.0008	0.0010	0.0012	0.0016	0.0018	0.0020
	Stainless Steel 300 Series 304, 316, 17-4PH, etc.	135 - 185	125	0.0008	0.0010	0.0012	0.0016	0.0018	0.0020
		185 - 275	75	0.0008	0.0010	0.0012	0.0016	0.0018	0.0020
	Super Duplex Stainless Steel	135 - 185	125	0.0006	0.0008	0.0012	0.0016	0.0018	0.0020
185 - 275		75	0.0006	0.0008	0.0012	0.0016	0.0018	0.0020	
H	Hardened Steels	450 - 500	175	0.0006	0.0008	0.0012	0.0016	0.0018	0.0020
		500 - 550	125	0.0006	0.0008	0.0012	0.0016	0.0018	0.0020
K	Cast Iron Grey, Ductile, Nodular	120 - 150	275	0.0008	0.0010	0.0014	0.0018	0.0020	0.0030
		150 - 200	250	0.0008	0.0010	0.0014	0.0018	0.0020	0.0030
		200 - 220	225	0.0008	0.0010	0.0014	0.0018	0.0020	0.0030
		220 - 260	200	0.0008	0.0010	0.0014	0.0018	0.0020	0.0030
		260 - 320	200	0.0008	0.0010	0.0014	0.0018	0.0020	0.0030
N	Wrought Aluminum	30	500	0.0010	0.0012	0.0018	0.0020	0.0030	0.0040
		180	450	0.0010	0.0012	0.0018	0.0020	0.0030	0.0040
	Cast Aluminum	30 - 180	250	0.0010	0.0012	0.0018	0.0020	0.0030	0.0040
	Brass	30 - 100	500	0.0010	0.0012	0.0018	0.0020	0.0030	0.0040



**Recommended Cutting Data | Metric (mm)**

Solid Carbide | AccuThread™ T3

ISO	Material	Hardness (BHN)	Speed (M/min)	Chipload per Tooth (mm/tooth) by Cutter Diameter			
				1.40 to 3.17	3.18 to 4.77	4.78 to 6.35	6.36 to 7.92
P	Free Machining Steel 1118, 1215, 12L14, etc.	100 - 150	115	0.020	0.025	0.035	0.045
		150 - 200	85	0.020	0.025	0.035	0.045
		200 - 250	70	0.020	0.025	0.035	0.045
	Low Carbon Steel 1010, 1020, 1025, 1522, 1144, etc.	85 - 125	115	0.020	0.025	0.035	0.045
		125 - 175	85	0.020	0.025	0.035	0.045
		175 - 225	70	0.020	0.025	0.035	0.045
		225 - 275	60	0.020	0.025	0.035	0.045
	Medium Carbon Steel 1030, 1040, 1050, 1527, 1140, 1151, etc.	125 - 175	70	0.020	0.025	0.030	0.040
		175 - 225	60	0.020	0.025	0.030	0.040
		225 - 275	50	0.020	0.025	0.030	0.040
		275 - 325	45	0.020	0.025	0.030	0.040
	Alloy Steel 4140, 5140, 8640, etc.	125 - 175	70	0.020	0.025	0.030	0.040
		175 - 225	60	0.020	0.025	0.030	0.040
		225 - 275	50	0.020	0.025	0.030	0.040
		275 - 325	45	0.020	0.025	0.030	0.040
		325 - 375	38	0.020	0.025	0.030	0.040
	High Strength Alloy 4340, 4330V, 300M, etc.	225 - 300	50	0.020	0.025	0.030	0.040
		300 - 350	45	0.020	0.025	0.030	0.040
		350 - 400	38	0.020	0.025	0.030	0.040
	Structural Steel A36, A285, A516, etc.	100 - 150	70	0.020	0.025	0.035	0.045
150 - 250		60	0.020	0.025	0.035	0.045	
250 - 350		45	0.020	0.025	0.035	0.045	
Tool Steel H-13, H-21, A-4, O-2, S-3, etc.	150 - 200	50	0.020	0.025	0.030	0.040	
	200 - 250	38	0.020	0.025	0.030	0.040	
S	High Temp Alloy Hastelloy B, Inconel 600, etc.	140 - 220	30	0.015	0.020	0.030	0.040
		220 - 310	23	0.015	0.020	0.030	0.040
	Titanium Alloy	140 - 220	30	0.015	0.020	0.030	0.040
		220 - 310	23	0.015	0.020	0.030	0.040
	Aerospace Alloy S82	185 - 275	30	0.015	0.020	0.030	0.040
275 - 350		23	0.015	0.020	0.030	0.040	
M	Stainless Steel 416, 420, etc.	185 - 275	70	0.020	0.025	0.030	0.040
		275 - 350	60	0.020	0.025	0.030	0.040
	Stainless Steel 300 Series 304, 316, 17-4PH, etc.	135 - 185	38	0.020	0.025	0.030	0.040
		185 - 275	23	0.020	0.025	0.030	0.040
	Super Duplex Stainless Steel	135 - 185	38	0.015	0.020	0.030	0.040
185 - 275		23	0.015	0.020	0.030	0.040	
H	Hardened Steels	450 - 500	50	0.015	0.020	0.030	0.040
		500 - 550	38	0.015	0.020	0.030	0.040
K	Cast Iron Grey, Ductile, Nodular	120 - 150	85	0.020	0.025	0.035	0.045
		150 - 200	75	0.020	0.025	0.035	0.045
		200 - 220	70	0.020	0.025	0.035	0.045
		220 - 260	60	0.020	0.025	0.035	0.045
		260 - 320	60	0.020	0.025	0.035	0.045
N	Wrought Aluminum	30	150	0.025	0.030	0.045	0.050
		180	135	0.025	0.030	0.045	0.050
	Cast Aluminum	30 - 180	75	0.025	0.030	0.045	0.050
Brass	30 - 100	150	0.025	0.030	0.045	0.050	

A  
DRILLING  
B  
BORING  
C  
REAMING  
D  
BURNISHING  
E  
THREADING  
X  
SPECIALS

## Recommended Cutting Data | Imperial (inch)

Indexable | AccuThread™ 856 | Positive Rake

ISO	Material	Hardness (BHN)	Machinability**	Speed (SFM)	Recommended Feed (inch/tooth) by Cutter Diameter						
					1 flute		1 and 2 flutes	3 flutes	5 flutes	7 flutes	8 flutes
					0.375 - 0.500	0.501 - 0.750	0.751 - 1.000	1.001 - 1.500	1.501 - 2.000	2.001 - 2.750	2.751 - 3.500
P	Free Machining Steel 1118, 1215, 12L14, etc.	100 - 150	Easy	900	0.0008	0.0010	0.0012	0.0015	0.0020	0.0025	0.0030
		150 - 200	Easy	700	0.0008	0.0010	0.0012	0.0015	0.0020	0.0025	0.0030
		200 - 250	Easy	500	0.0008	0.0010	0.0012	0.0015	0.0020	0.0025	0.0030
	Low Carbon Steel 1010, 1020, 1025, 1522, 1144	85 - 125	Average	900	0.0008	0.0010	0.0012	0.0015	0.0020	0.0025	0.0030
		125 - 175	Average	700	0.0008	0.0010	0.0012	0.0015	0.0020	0.0025	0.0030
		175 - 225	Average	600	0.0008	0.0010	0.0012	0.0015	0.0020	0.0025	0.0030
		225 - 275	Average	500	0.0008	0.0010	0.0012	0.0015	0.0020	0.0025	0.0030
	Medium Carbon Steel 1010, 1040, 1050, 1527, 1140	125 - 175	Average	575	0.0008	0.0009	0.0010	0.0012	0.0015	0.0020	0.0025
		175 - 225	Average	500	0.0008	0.0009	0.0010	0.0012	0.0015	0.0020	0.0025
		225 - 275	Average	450	0.0008	0.0009	0.0010	0.0012	0.0015	0.0020	0.0025
		275 - 325	Average	400	0.0008	0.0009	0.0010	0.0012	0.0015	0.0020	0.0025
	Alloy Steel 4140, 5140, 8640	125 - 175	Average	575	0.0008	0.0009	0.0010	0.0012	0.0015	0.0020	0.0025
		175 - 225	Average	500	0.0008	0.0009	0.0010	0.0012	0.0015	0.0020	0.0025
		225 - 275	Average	450	0.0008	0.0009	0.0010	0.0012	0.0015	0.0020	0.0025
		275 - 325	Difficult	400	0.0008	0.0009	0.0010	0.0012	0.0015	0.0020	0.0025
		325 - 375	Difficult	375	0.0008	0.0009	0.0010	0.0012	0.0015	0.0020	0.0025
	High Strength Alloy 4340, 4330V, 300M	225 - 300	Average	450	0.0008	0.0009	0.0010	0.0012	0.0015	0.0020	0.0025
		300 - 350	Difficult	400	0.0008	0.0009	0.0010	0.0012	0.0015	0.0020	0.0025
350 - 400		Difficult	350	0.0008	0.0009	0.0010	0.0012	0.0015	0.0020	0.0025	
Structural Steel A36, A285, A516	100 - 150	Average	600	0.0008	0.0010	0.0012	0.0015	0.0020	0.0025	0.0030	
	150 - 250	Average	500	0.0008	0.0010	0.0012	0.0015	0.0020	0.0025	0.0030	
	250 - 350	Difficult	450	0.0008	0.0010	0.0012	0.0015	0.0020	0.0025	0.0030	
S	High Temp Alloy Hastelloy B, Inconel 600	140 - 220	Difficult	120	0.0005	0.0006	0.0008	0.0010	0.0015	0.0020	0.0025
		220 - 310	Difficult	90	0.0005	0.0006	0.0008	0.0010	0.0015	0.0020	0.0025
M	Stainless Steel 303, 416, 420	135 - 185	Difficult	525	0.0005	0.0007	0.0009	0.0015	0.0020	0.0025	0.0030
		185 - 275	Difficult	500	0.0005	0.0007	0.0009	0.0015	0.0020	0.0025	0.0030
	Stainless Steel PH 17-4	185 - 275	Difficult	300	0.0005	0.0007	0.0009	0.0015	0.0020	0.0025	0.0030
		275 - 325	Difficult	150	0.0005	0.0007	0.0009	0.0015	0.0020	0.0025	0.0030
	Tool Steel H-13, H21, A-4	150 - 200	Difficult	575	0.0008	0.0010	0.0012	0.0015	0.0020	0.0025	0.0030
200 - 250		Difficult	500	0.0008	0.0010	0.0012	0.0015	0.0020	0.0025	0.0030	
K	Cast Iron Grey, Ductile, Nodular	120 - 150	Easy	675	0.0008	0.0012	0.0015	0.0020	0.0030	0.0040	0.0050
		150 - 200	Easy	625	0.0008	0.0012	0.0015	0.0020	0.0030	0.0040	0.0050
		200 - 220	Easy	575	0.0008	0.0012	0.0015	0.0020	0.0030	0.0040	0.0050
		220 - 260	Average	500	0.0008	0.0012	0.0015	0.0020	0.0030	0.0040	0.0050
		260 - 320	Average	475	0.0008	0.0012	0.0015	0.0020	0.0030	0.0040	0.0050
N	Wrought Aluminum 6061 T6	30	Easy	1100	0.0015	0.0020	0.0025	0.0030	0.0040	0.0050	0.0060
		180	Easy	1000	0.0015	0.0020	0.0025	0.0030	0.0040	0.0050	0.0060
	Cast Aluminum** up to 10% silicon	120	Easy	625	0.0015	0.0020	0.0025	0.0030	0.0040	0.0050	0.0060
	Brass	30 - 125	Easy	1100	0.0020	0.0025	0.0030	0.0040	0.0045	0.0055	0.0065

**NOTICE:** Reduce feed and speed by 30% for tapered thread forms due to additional material removal

\*Refer to recommended pass chart on page E: 45 when referencing material machinability

\*\*Uncoated thread mills are recommended for cast aluminum applications

## Recommended Cutting Data | Metric (mm)

Indexable | AccuThread™ 856 | Positive Rake

ISO	Material	Hardness (BHN)	Machinability**	Speed (M/min)	Recommended Feed (mm/tooth) by Cutter Diameter						
					1 flute		1 and 2 flutes	3 flutes	5 flutes	7 flutes	8 flutes
					9.53 - 12.70	12.71 - 19.05	19.06 - 25.40	25.41 - 38.10	38.11 - 50.80	50.81 - 69.85	69.86 - 88.90
P	Free Machining Steel 1118, 1215, 12L14, etc.	100 - 150	Easy	274	0.020	0.025	0.030	0.038	0.051	0.064	0.076
		150 - 200	Easy	213	0.020	0.025	0.030	0.038	0.051	0.064	0.076
		200 - 250	Easy	152	0.020	0.025	0.030	0.038	0.051	0.064	0.076
	Low Carbon Steel 1010, 1020, 1025, 1522, 1144	85 - 125	Average	274	0.020	0.025	0.030	0.038	0.051	0.064	0.076
		125 - 175	Average	213	0.020	0.025	0.030	0.038	0.051	0.064	0.076
		175 - 225	Average	183	0.020	0.025	0.030	0.038	0.051	0.064	0.076
		225 - 275	Average	152	0.020	0.025	0.030	0.038	0.051	0.064	0.076
	Medium Carbon Steel 1010, 1040, 1050, 1527, 1140	125 - 175	Average	175	0.020	0.023	0.025	0.030	0.038	0.051	0.064
		175 - 225	Average	152	0.020	0.023	0.025	0.030	0.038	0.051	0.064
		225 - 275	Average	137	0.020	0.023	0.025	0.030	0.038	0.051	0.064
		275 - 325	Average	122	0.020	0.023	0.025	0.030	0.038	0.051	0.064
	Alloy Steel 4140, 5140, 8640	125 - 175	Average	175	0.020	0.023	0.025	0.030	0.038	0.051	0.064
		175 - 225	Average	152	0.020	0.023	0.025	0.030	0.038	0.051	0.064
		225 - 275	Average	137	0.020	0.023	0.025	0.030	0.038	0.051	0.064
		275 - 325	Difficult	122	0.020	0.023	0.025	0.030	0.038	0.051	0.064
		325 - 375	Difficult	114	0.020	0.023	0.025	0.030	0.038	0.051	0.064
	High Strength Alloy 4340, 4330V, 300M	225 - 300	Average	137	0.020	0.023	0.025	0.030	0.038	0.051	0.064
		300 - 350	Difficult	122	0.020	0.023	0.025	0.030	0.038	0.051	0.064
350 - 400		Difficult	107	0.020	0.023	0.025	0.030	0.038	0.051	0.064	
Structural Steel A36, A285, A516	100 - 150	Average	183	0.020	0.025	0.030	0.038	0.051	0.064	0.076	
	150 - 250	Average	152	0.020	0.025	0.030	0.038	0.051	0.064	0.076	
	250 - 350	Difficult	137	0.020	0.025	0.030	0.038	0.051	0.064	0.076	
S	High Temp Alloy Hastelloy B, Inconel 600	140 - 220	Difficult	37	0.013	0.015	0.020	0.025	0.038	0.051	0.064
		220 - 310	Difficult	27	0.013	0.015	0.020	0.025	0.038	0.051	0.064
M	Stainless Steel 303, 416, 420	135 - 185	Difficult	160	0.013	0.018	0.023	0.038	0.051	0.064	0.076
		185 - 275	Difficult	152	0.013	0.018	0.023	0.038	0.051	0.064	0.076
	Stainless Steel PH 17-4	185 - 275	Difficult	91	0.013	0.018	0.023	0.038	0.051	0.064	0.076
		275 - 325	Difficult	46	0.013	0.018	0.023	0.038	0.051	0.064	0.076
	Tool Steel H-13, H21, A-4	150 - 200	Difficult	175	0.020	0.025	0.030	0.038	0.051	0.064	0.076
200 - 250		Difficult	152	0.020	0.025	0.030	0.038	0.051	0.064	0.076	
K	Cast Iron Grey, Ductile, Nodular	120 - 150	Easy	206	0.020	0.030	0.038	0.051	0.076	0.102	0.127
		150 - 200	Easy	191	0.020	0.030	0.038	0.051	0.076	0.102	0.127
		200 - 220	Easy	175	0.020	0.030	0.038	0.051	0.076	0.102	0.127
		220 - 260	Average	152	0.020	0.030	0.038	0.051	0.076	0.102	0.127
		260 - 320	Average	145	0.020	0.030	0.038	0.051	0.076	0.102	0.127
N	Wrought Aluminum 6061 T6	30	Easy	335	0.038	0.051	0.064	0.076	0.102	0.127	0.152
		180	Easy	305	0.038	0.051	0.064	0.076	0.102	0.127	0.152
	Cast Aluminum** up to 10% silicon	120	Easy	191	0.038	0.051	0.064	0.076	0.102	0.127	0.152
	Brass	30 - 125	Easy	335	0.051	0.064	0.076	0.102	0.114	0.140	0.165

**NOTICE:** Reduce feed and speed by 30% for tapered thread forms due to additional material removal

\*Refer to recommended pass chart on page E: 45 when referencing material machinability

\*\*Uncoated thread mills are recommended for cast aluminum applications

## Recommended Cutting Data | Imperial (inch)

Indexable | AccuThread™ 856 | Neutral Rake

ISO	Material	Hardness (BHN)	Machinability**	Speed (SFM)	Recommended Feed (inch/tooth) by Cutter Diameter		
					3 flutes 1.000 - 1.499	5 flutes 1.500 - 1.999	6 flutes 2.000 - 2.750
P	Free Machining Steel 1118, 1215, 12L14, etc.	100 - 150	Easy	765	0.0013	0.0017	0.0021
		150 - 200	Easy	595	0.0013	0.0017	0.0021
		200 - 250	Easy	425	0.0013	0.0017	0.0021
	Low Carbon Steel 1010, 1020, 1025, 1522, 1144	85 - 125	Average	765	0.0013	0.0017	0.0021
		125 - 175	Average	595	0.0013	0.0017	0.0021
		175 - 225	Average	510	0.0013	0.0017	0.0021
		225 - 275	Average	425	0.0013	0.0017	0.0021
	Medium Carbon Steel 1010, 1040, 1050, 1527, 1140	125 - 175	Average	490	0.0010	0.0013	0.0017
		175 - 225	Average	425	0.0010	0.0013	0.0017
		225 - 275	Average	380	0.0010	0.0013	0.0017
		275 - 325	Average	340	0.0010	0.0013	0.0017
	Alloy Steel 4140, 5140, 8640	125 - 175	Average	490	0.0010	0.0013	0.0017
		175 - 225	Average	425	0.0010	0.0013	0.0017
		225 - 275	Average	380	0.0010	0.0013	0.0017
		275 - 325	Difficult	340	0.0010	0.0013	0.0017
		325 - 375	Difficult	320	0.0010	0.0013	0.0017
	High Strength Alloy 4340, 4330V, 300M	225 - 300	Average	390	0.0010	0.0013	0.0017
		300 - 350	Difficult	340	0.0010	0.0013	0.0017
350 - 400		Difficult	300	0.0010	0.0013	0.0017	
Structural Steel A36, A285, A516	100 - 150	Average	510	0.0013	0.0017	0.0021	
	150 - 250	Average	425	0.0013	0.0017	0.0021	
	250 - 350	Difficult	390	0.0013	0.0017	0.0021	
S	High Temp Alloy Hastelloy B, Inconel 600	140 - 220	Difficult	-	-	-	
		220 - 310	Difficult	-	-	-	
M	Stainless Steel 303, 416, 420	135 - 185	Difficult	-	-	-	
		185 - 275	Difficult	-	-	-	
	Stainless Steel PH 17-4	185 - 275	Difficult	-	-	-	
		275 - 325	Difficult	-	-	-	
	Tool Steel H-13, H21, A-4	150 - 200	Difficult	-	-	-	
200 - 250		Difficult	-	-	-		
K	Cast Iron Grey, Ductile, Nodular	120 - 150	Easy	575	0.0017	0.0026	0.0034
		150 - 200	Easy	525	0.0017	0.0026	0.0034
		200 - 220	Easy	490	0.0017	0.0026	0.0034
		220 - 260	Average	425	0.0017	0.0026	0.0034
		260 - 320	Average	400	0.0017	0.0026	0.0034
N	Wrought Aluminum 6061 T6	30	Easy	-	-	-	
		180	Easy	-	-	-	
	Cast Aluminum** up to 10% silicon	120	Easy	-	-	-	
	Brass	30 - 125	Easy	-	-	-	

**NOTICE:** Reduce feed and speed by 30% for tapered thread forms due to additional material removal

\*Refer to recommended pass chart on page E: 45 when referencing material machinability

\*\*Uncoated thread mills are recommended for cast aluminum applications

## Recommended Cutting Data | Metric (mm)

Indexable | AccuThread™ 856 | Neutral Rake

ISO	Material	Hardness (BHN)	Machinability**	Speed (M/min)	Recommended Feed (mm/tooth) by Cutter Diameter		
					3 flutes	5 flutes	6 flutes
					25.41 - 38.09	38.10 - 50.77	50.78 - 69.85
P	Free Machining Steel 1118, 1215, 12L14, etc.	100 - 150	Easy	233	0.032	0.043	0.054
		150 - 200	Easy	181	0.032	0.043	0.054
		200 - 250	Easy	129	0.032	0.043	0.054
	Low Carbon Steel 1010, 1020, 1025, 1522, 1144	85 - 125	Average	233	0.032	0.043	0.054
		125 - 175	Average	181	0.032	0.043	0.054
		175 - 225	Average	156	0.032	0.043	0.054
		225 - 275	Average	129	0.032	0.043	0.054
	Medium Carbon Steel 1010, 1040, 1050, 1527, 1140	125 - 175	Average	149	0.026	0.032	0.043
		175 - 225	Average	129	0.026	0.032	0.043
		225 - 275	Average	116	0.026	0.032	0.043
		275 - 325	Average	104	0.026	0.032	0.043
	Alloy Steel 4140, 5140, 8640	125 - 175	Average	149	0.026	0.032	0.043
		175 - 225	Average	129	0.026	0.032	0.043
		225 - 275	Average	116	0.026	0.032	0.043
		275 - 325	Difficult	104	0.026	0.032	0.043
		325 - 375	Difficult	97	0.026	0.032	0.043
	High Strength Alloy 4340, 4330V, 300M	225 - 300	Average	116	0.026	0.032	0.043
		300 - 350	Difficult	104	0.026	0.032	0.043
		350 - 400	Difficult	91	0.026	0.032	0.043
	Structural Steel A36, A285, A516	100 - 150	Average	156	0.032	0.043	0.054
150 - 250		Average	129	0.032	0.043	0.054	
250 - 350		Difficult	116	0.032	0.043	0.054	
S	High Temp Alloy Hastelloy B, Inconel 600	140 - 220	Difficult	-	-	-	
		220 - 310	Difficult	-	-	-	
M	Stainless Steel 303, 416, 420	135 - 185	Difficult	-	-	-	
		185 - 275	Difficult	-	-	-	
	Stainless Steel PH 17-4	185 - 275	Difficult	-	-	-	
		275 - 325	Difficult	-	-	-	
	Tool Steel H-13, H21, A-4	150 - 200	Difficult	-	-	-	
200 - 250		Difficult	-	-	-		
K	Cast Iron Grey, Ductile, Nodular	120 - 150	Easy	175	0.043	0.065	0.087
		150 - 200	Easy	162	0.043	0.065	0.087
		200 - 220	Easy	149	0.043	0.065	0.087
		220 - 260	Average	129	0.043	0.065	0.087
		260 - 320	Average	123	0.043	0.065	0.087
N	Wrought Aluminum 6061 T6	30	Easy	-	-	-	
		180	Easy	-	-	-	
	Cast Aluminum** up to 10% silicon	120	Easy	-	-	-	
	Brass	30 - 125	Easy	-	-	-	

**NOTICE:** Reduce feed and speed by 30% for tapered thread forms due to additional material removal

\*Refer to recommended pass chart on page E: 45 when referencing material machinability

\*\*Uncoated thread mills are recommended for cast aluminum applications

A  
DRILLING  
B  
BORING  
C  
REAMING  
D  
BURNISHING  
E  
THREADING  
X  
SPECIALS

## Thread Mill Programming Guide

### What you need to know

- Thread milling can be easily accomplished with simple G code programming
- If your machine is capable of 3 axis (helical) interpolation, you can and **should** be thread milling
- Basic programming of a one pass thread mill can be achieved in 6 basic steps

**AVAILABLE ONLINE 24/7**  
**or download INSTA-CODE™**

visit [www.alliedmachine.com](http://www.alliedmachine.com)

The following are examples of how to calculate and program a 7/16-20 right hand thread that will be 1/2 deep produced in one pass

Major thread diameter	<b>0.4375</b>	Major diameter of thread (7/16 = 0.4375)
Threads per inch	<b>20</b>	Number of threads per inch (20 is from 7/16-20 designation)
Length of thread	<b>0.5</b>	Desired length of cut
SFM	<b>475</b>	Recommended surface footage for material to be cut
Feed per flute	<b>0.0025</b>	Recommended feed rate per cutting edge
Number of flutes	<b>4</b>	Number of flutes on tool to be used
Tool diameter	<b>0.335</b>	Diameter of cutting tool
<b>Using the information above, the values can be calculated:</b>		
Pitch	<b>0.05</b>	= 1 / thread per inch
RPM	<b>5416</b>	(SFM • 3.82) / Tool diameter
Linear feed	<b>54.16</b>	RPM • Feed per flute • Number of flutes
Feed rate for thread milling	<b>12.69</b>	Linear feed • ((Major thread diameter - Tool diameter) / Major thread diameter)
Z axis move on arc on	<b>0.0063</b>	(Pitch / 8)
Z axis move for full thread	<b>0.5063</b>	(Pitch / 8) + Length of cut
Arc on/off	<b>0.0256</b>	(Major thread diameter - Tool diameter) / 4
Full rotation value	<b>0.05125</b>	(Major thread diameter - Tool diameter) / 2

Major thread diameter	0.4375
Cutter diameter	0.335
Length of thread	0.5

Feed rate for thread milling	12.69
Z axis depth for full thread	0.5063
Z axis for arc on/off	0.0063

Arc on/off value	0.0256
Full rotation value	0.05125
Pitch value	0.05

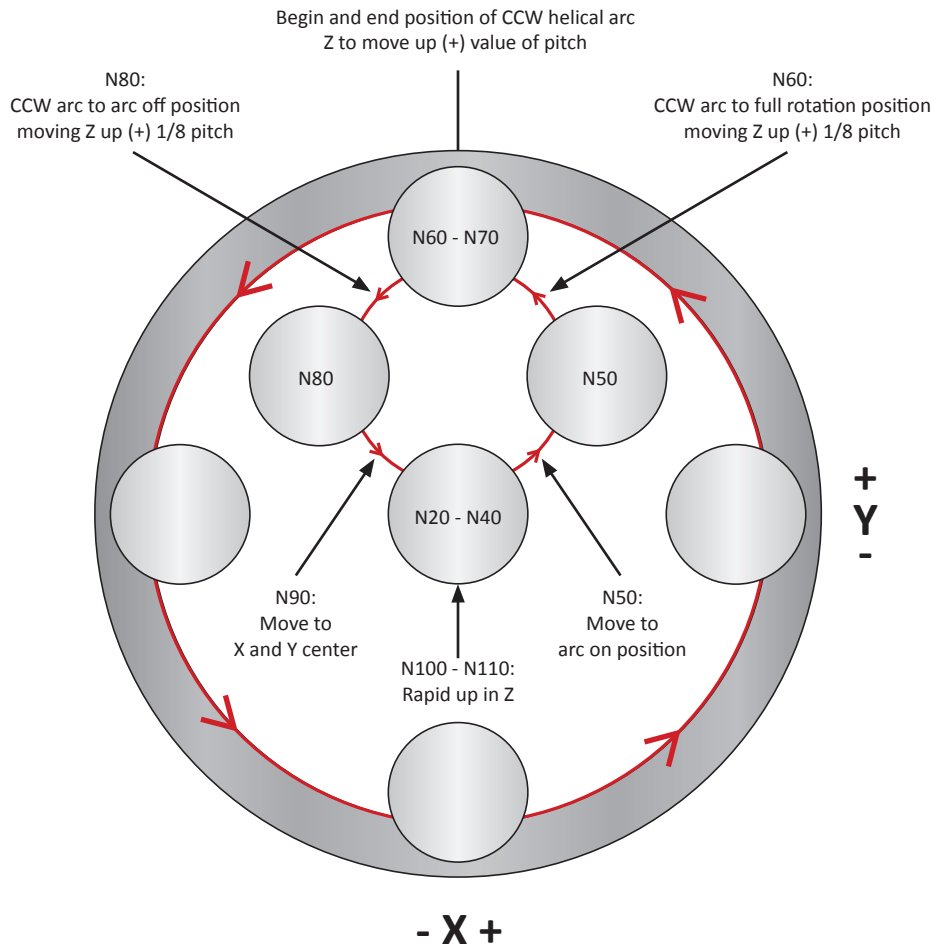

1	N10	S	5416 M03				Absolute position in rapid to center of hole in X and Y, then rapid to Z0 (level with surface of hole)(assumed to be X0, Y0, Z0 for demonstration purposes). To be done by customer.			
	N20	G90	G00	X 0.0000	Y 0.0000					
	N30					Z 0.0000				
2	N 40	G91	G01		Z -0.5063	F 50.0				
			Switch to incremental positioning and high feed to Z axis depth for full thread.							
3	N50	G41	G01		X 0.0256	Y 0.0256	D1	F 3.17		
			Activate left diameter compensation for tool number 1 (needs to be whatever tool number you are using) and feed to arc on/off position at 1/4 feed rate for thread milling.							
	N60			G03	X -0.0256	Y 0.0256	Z 0.0063	I -0.0256	J 0.0000	F 12.69
		CCW arc from full rotation from the arc on position at the calculated thread milling feed rate moving Z up (+) 1/8 pitch value (Z axis move up for arc on/off). X and Y positions are the incremental distance from where tool is to where it will be after arc (arc on/off value). I is the incremental X value of center of rotation from where tool currently is arc on/off value *-1. J is the incremental Y value from current tool position to center of rotation.								
4	N70			G03	X 0.0000	Y 0.0000	Z 0.0500	I 0.0000	J -0.0513	F 12.69
			One complete CCW arc from the full arc rotation position at the calculated thread milling feed rate moving Z up (positive pitch value). I and J values are calculated same as above. I will be 0.0 and J will be full rotation value *-1.							
5	N80			G03	X -0.0256	Y -0.0256	Z 0.0063	I 0.0000	J -0.0256	F 25.38
			CCW arc from full rotation diameter to arc off position at double the calculated thread milling feed rate moving Z up (+) 1/8 pitch value (Z axis move up for arc on/off). I and J values are calculated same as above.							
	N90	G40	G01		X 0.0256	Y -0.0256				
		Shut off cutter comp and move from arc off position to center of hole in X (arc on/off value -1) and Y (arc on/off value *-1) at high feed rate.								
6	N100			G00	Z 0.4438					
			Rapid Z up incremental value (length of thread - all Z values in G03 arc commands).							
	N110	G90	G00		Z 1.0000					
		Switch back to absolute positioning and rapid to a safe point in Z above part level (assumed to be 1 above part level for demonstration purposes).								

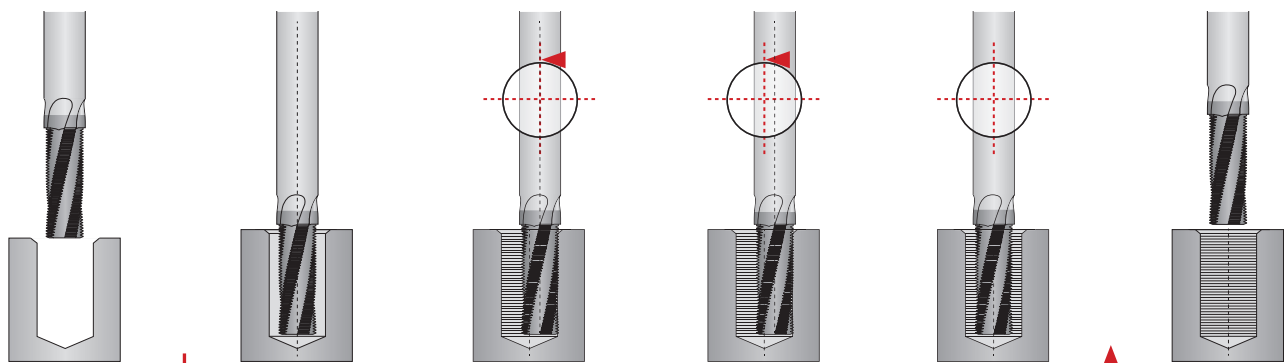

Step 1 N10 - N30	Step 2 N40	Step 3 N50 - N60	Step 4 N70	Step 5 N80 - N90	Step 6 N100 - N110
<ul style="list-style-type: none"> <li>Preparatory commands</li> <li>Positioning above hole center and at hole level in Z</li> <li>In absolute position mode</li> </ul>	<ul style="list-style-type: none"> <li>Change to incremental</li> <li>Feed to bottom of hole</li> <li>Z axis depth for full thread</li> </ul>	<ul style="list-style-type: none"> <li>Activate left cutter comp</li> <li>Feed to arc on position</li> <li>Arc to full rotation value while moving Z up 1/8 pitch</li> <li>Z axis move for arc on</li> </ul>	<ul style="list-style-type: none"> <li>One complete CCW rotation at full arc rotation value while moving Z up 1 pitch value</li> </ul>	<ul style="list-style-type: none"> <li>CCW arc from full rotation value to the arc on/off value while moving Z up 1/8 pitch (Z axis move for arc off)</li> </ul>	<ul style="list-style-type: none"> <li>Rapid up in Z</li> </ul>

## Technical Information

### AccuThread™ T3

#### Spindle Rotation

**!** Tools are left hand cutting. The left hand cut allows the tool to climb mill when creating a right hand thread with an AccuThread T3. Climb milling reduces deflection and heat generated during the cut.

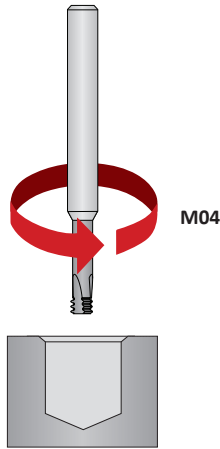

#### Direction of Helical Interpolation

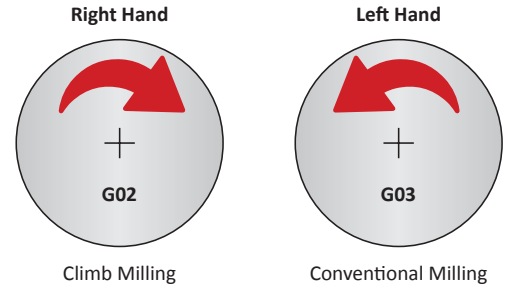

#### Programming Z-Axis Cutting Path

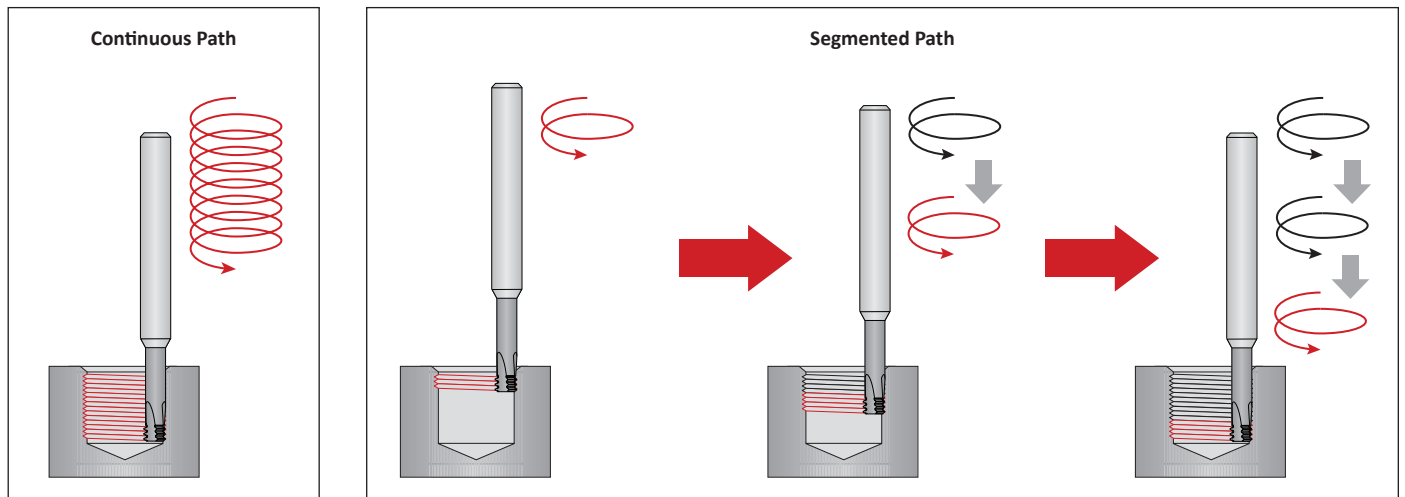

Start Point

Center Location

Arc Entrance

Thread Milling

Arc Exit

End Point

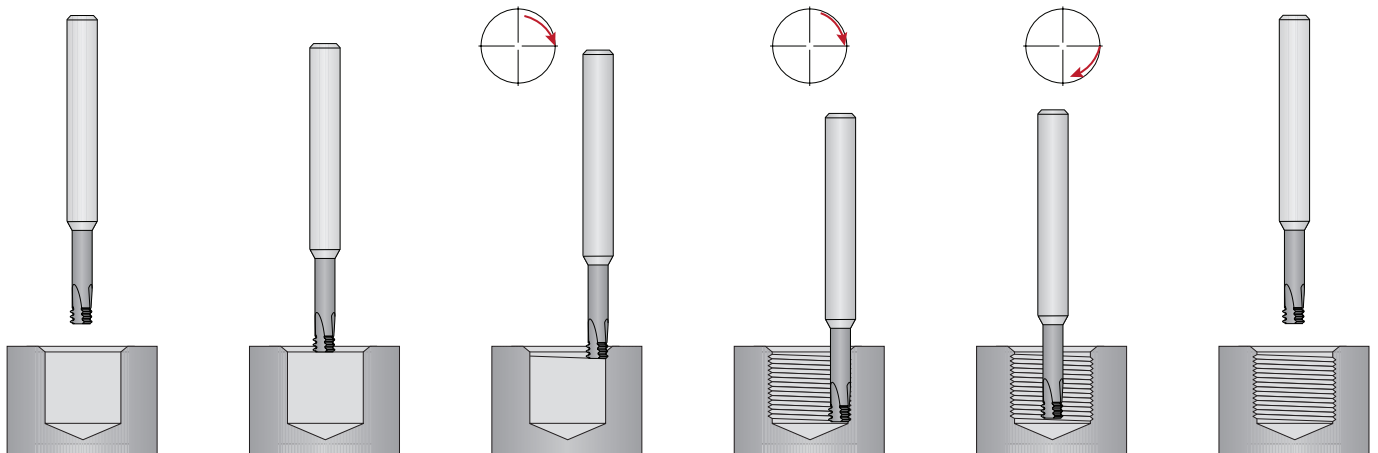







## Thread Mill Troubleshooting Guide

		Problem										
		Thread mill is showing accelerated or excessive wear	Cutting edges are chipping	Thread mill is breaking in the first hole of part	Thread mill is creating excessive chatter	Out of round thread is produced	Bell mouthed thread form (small at bottom, big at top)	Part rejection because of rough flank finish	Steps in thread profile	Gauge difference from part to part	Machine not making correct paths to create thread profile	Control not accepting the program
Causes												
Catalog	Incorrect tool selection			1	1							
	Incorrect speed and feed selection	2, 3	2, 3		2, 3			2, 3				
Speed and Feed	RPM too high	5										
	RPM too low				4		4	4				
	Machine tool specifications restrict RPMs			5, 19								
	Feed rate too high		7	7			7	7	7			
	Feed rate too low	6										
	Incorrect adjusted feed rate adjustment ratio			12								
	Machine tool specification restricts feed rate					7, 19						
	Ramp-in is programmed as an axial move			20					20			
Tool	Thread mill moved or slipped in its holding device	13	13	13	13			13	13			
	Tool is sticking out of the holder too far	15	15	15	15			15	15	15		
	Runout between thread mill and holder				10			10				
	Incorrect coating creating built up edge	8, 17								8, 17		
	Helix angle too low				9			9				
	Excessive thread mill wear								11	11		
	Excessive tool pressure	7, 11, 14						7, 11, 14				
Machine	Workpiece moving in its fixturing	16	16	16	16			16		16		
	Insufficient coolant pressure or flow	17	17									
	Lack of machine rigidity	16	16		16		16	16				
Programming	Incorrect number of passes			22			22					
	Incorrect program variables			18, 26							18, 26	
	Did not account for X/Y radial moves for tapered threads										24, 26	
	Incorrect cutter compensation variables			23, 26								23, 26
	Helical interpolation option not on machine or turned off										21, 26	21, 26
	Machine tool control is not formatted to standard EIA/ASCII/ISO Code											25, 26

**Troubleshooting Solutions**

1. Refer to catalog to ensure proper tool selection.
2. Verify the correct speed was selected from the catalog speed and feed chart.
3. Verify the correct feed rate was selected from the catalog speed and feed chart.
4. Increase the spindle speed (RPM).
5. Decrease the spindle speed (RPM).
6. Increase feed per tooth.
7. Decrease feed per tooth.
8. Investigate other coatings.
9. Increase the tool helix.
10. Gauge runout between thread mill and tool holder.
11. Perform tool change at quicker intervals.
12. Adjust the feed rate ratio properly to the correct actual penetration rate for internal threads. Refer to speed and feed pages for formula.
13. Use hydraulic clamping chuck.
14. Check the tool for excessive wear. Beginning threads will wear the fastest.
15. Make the amount of overhang in the holding device as short as possible.
16. Verify the workpiece is properly clamped. Re-tighten or increase stability if necessary.
17. Increase the coolant flow and volume.
18. Check the milling program variables, especially the positive or negative value associated with I and J values.
19. Make sure the machine has the appropriate axis and path speed capabilities.
20. Make sure the thread mill is arcing in the major diameter instead of making a radial move.
21. Make sure the machine tool has a helical interpolation option that is on.
22. Increase the number of thread mill passes.
23. Make sure the cutter compensation variables are input into the G41 program line.
24. Adjust the program for pipe tap threads to taper out on diameter in X/Y directions to create proper form.
25. Request information from the machine tool builder regarding its programming formats.
26. Scan and email a copy of your program to the Application Engineering department at [appeng@alliedmachine.com](mailto:appeng@alliedmachine.com).



SECTION

---

X

---

Special Tooling Solutions

# Special Tooling Solutions

Superion™ | Insta-Quote™ | Engineered Specials



## Specialty is Our Specialty

It's true. When it comes to designing and developing special solutions for customers, Allied Machine is the top choice. Our engineers see applications in ways many others don't, and that ability allows us to win situations that haven't been won before.

If you have a particularly unique or difficult application, give us a call. Most of our tooling can be tweaked as specials, and we can create entirely new concepts if alterations to standard product won't do the trick.

After all, everyone deserves some special attention.



Your safety and the safety of others is very important. This catalog contains important safety messages. Always read and follow all safety precautions.



This triangle is a safety hazard symbol. It alerts you to potential safety hazards that can cause tool failure and serious injury.

When you see this symbol in the catalog, look for a related safety message that may be near this triangle or referred to in the nearby text.

There are safety signal words also used in the catalog. Safety messages follow these words.

### **WARNING**

**WARNING** (shown above) means that failure to follow the precautions in this message could result in tool failure and serious injury.

**NOTICE** means that failure to follow the precautions in this message could result in damage to the tool or machine but not result in personal injury.

**NOTE** and **IMPORTANT** are also used. These are important that you read and follow but are not safety-related.

Visit [www.alliedmachine.com](http://www.alliedmachine.com) for the most up-to-date information and procedures.

# Special Tooling Solutions Contents

## Introduction Information

Overview of Specials Capabilities . . . . . 2 - 3

**Superion™ Solid Carbide and PCD Tooling . . . . . 4 - 5**

### Insta-Quote™

Program Overview . . . . . 6

User Guide . . . . . 7 - 9

T-A® Inserts . . . . . 10

T-A® Holders . . . . . 11

GEN3SYS® XT Holders . . . . . 12

ALVAN® Reamers . . . . . 13

### Engineered Specials

Insert Designs . . . . . 14

Vaccum Drill . . . . . 15

Stealth Drill . . . . . 16

Success Stories . . . . . 17

i-Form . . . . . 18 - 19

Special Design Examples . . . . . 20 - 21

**QDSI® Inserts . . . . . 22 - 23**

**Send in Your Own Design . . . . . 24 - 25**

**Deep Hole Drilling Guidelines . . . . . 26**

## Special Tooling Options

### Special Tooling is Our Specialty

Allied Machine offers three methods for obtaining special tooling to solve any application problem you encounter: Superion™, Insta-Quote™, and Engineered Specials. We know standard tooling can't be the answer for everyone, and that's why we specialize in developing unique tooling to fit your needs.

Many of our products can be altered as specials. In fact, many of our standard items are results of frequently requested special features. Many times, one special design can end up solving problems for multiple customers across a variety of industries. Our specials capabilities truly sets us apart from our competition.

Our Application Engineering team and Field Sales Engineers are trained and highly skilled to develop unique solutions that you won't find anywhere else. If you need special tooling, give us a call. Let us be the ones to tell you it can't be done. But don't expect us to.

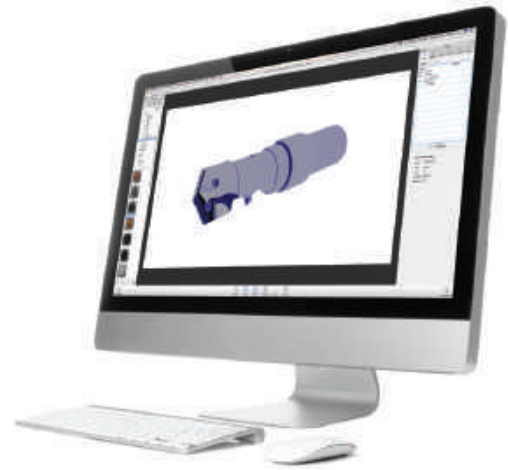

Solid Carbide Specials



### Advanced Capabilities

With the addition of the Superion™ solid carbide products, Allied Machine can now provide made-to-order special tooling to better help customers achieve optimal performance and productivity in their holemaking applications. Give us a call today and see the new solutions we can provide.

### Made-to-Order Solid Carbide Specials

- PCD Tooling
- Burnishing Drills
- Solid Carbide Drills
- Step Drills / PCD Step Reamers



Insta-Quote™

Insta-Quote is an online custom tool designer. The program is available 24/7 and guides you through the steps as you create a special tool designed to meet the requirements of your application.

### Products Available:

- T-A® Inserts
- T-A® Holders
- GEN3SYS® XT Holders
- ALVAN® Reamers



See pages X: 6 - 13



Engineered Specials

When the requirements of your application fall outside the limitations of Insta-Quote, your special tooling becomes an Engineered Special. These are tool designs that our engineers get to create and develop specifically for you.

### Reasons to Call:

- Many standard products can be specially engineered
- Allied Machine specials can save you time and increase tool life
- Our engineers have the skills and knowledge to create designs that meet the challenge



See pages X: 18 - 19



## Industry Solutions

### Every Industry Needs Some Special Attention

Many specific industry applications can be tricky, and processes can change drastically from one sector to the next. Allied's Field Sales Engineers and Application Engineers work together to develop breakthrough solutions that help customers master processes that before seemed impossible to improve.

You know your parts. You know your materials. You know what works and what doesn't. All you need to do is let us know what you're dealing with, and we'll take it from there. Whether you're machining the wings of an airplane or the engine block in a new car, we'll develop the right design to solve the problem you're facing.

For more industry examples, see Allied Machine's Case Studies and Success Stories at [www.alliedmachine.com/RealLifeResults](http://www.alliedmachine.com/RealLifeResults).



**Automotive**  
Engine Block



**Aerospace**  
Central Fuselage Wing Box



**Heavy Machinery**  
Track Links



**Oil and Gas**  
Heat Exchanger

### COMPLEX SOLUTIONS



### INNOVATIVE SOLUTIONS



### LONG SOLUTIONS



EVERY PROBLEM  
HAS A  
**SOLUTION**

## Superion™

Solid Carbide and PCD Tooling Solutions



Solid Carbide / PCD Solutions



### WHAT IS SUPERION?

Superion capabilities provide cutting edge solutions in both solid carbide and PCD tooling.

### WHY SHOULD YOU USE SUPERION?

- State of the art manufacturing automation allows for high repeatability and consistency, regardless of the quantity you need.
- Superion provides application-specific solutions tailored to meet your toughest demands.
- Superion tooling excels in difficult and unique material applications.
- Our goal is to provide you a quality solution to exceed your need on a schedule that satisfies.

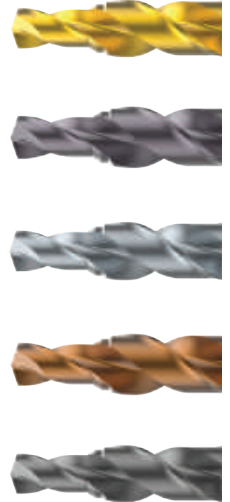

### WHEN SHOULD YOU USE SUPERION?

- When finish is critical and tolerances are tight, Superion can maintain your tolerances.
- When regrinds and re-manufacturability are critical for tooling budgets, Superion tackles your needs.
- If you're dealing with CFRP or other unique materials, Superion tooling is the right solution.

### SOLID CARBIDE TOOLING

- Ø 3 - 20mm
- Designs with up to 3 steps
- Lengths up to 20xD
- Coolant through options
- Different geometry options to optimize your specific application
- Regrinds are available



### SOLID CARBIDE PCD TOOLING

- Ø 3 - 20mm
- Brazed wafer to carbide body
- Ideal for CFRP and other unique materials
- Nib-style drills, end mills, and reamers
- Regrinds and PCD remanufactures are available



# Superion™

Solid Carbide and PCD Tooling Solutions

## From Concept to Reality

Allied's team of engineers is ready to assist you with your tooling design. We'll gather all the information we need about your application and turn your concept into reality. Give us a call today and watch as we collaborate with you and listen to the need, formulate a concept, develop the model, and build the solution.

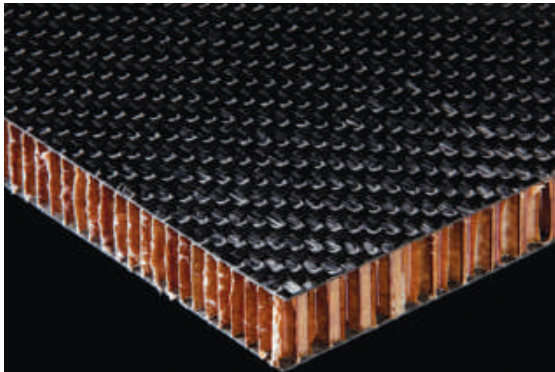
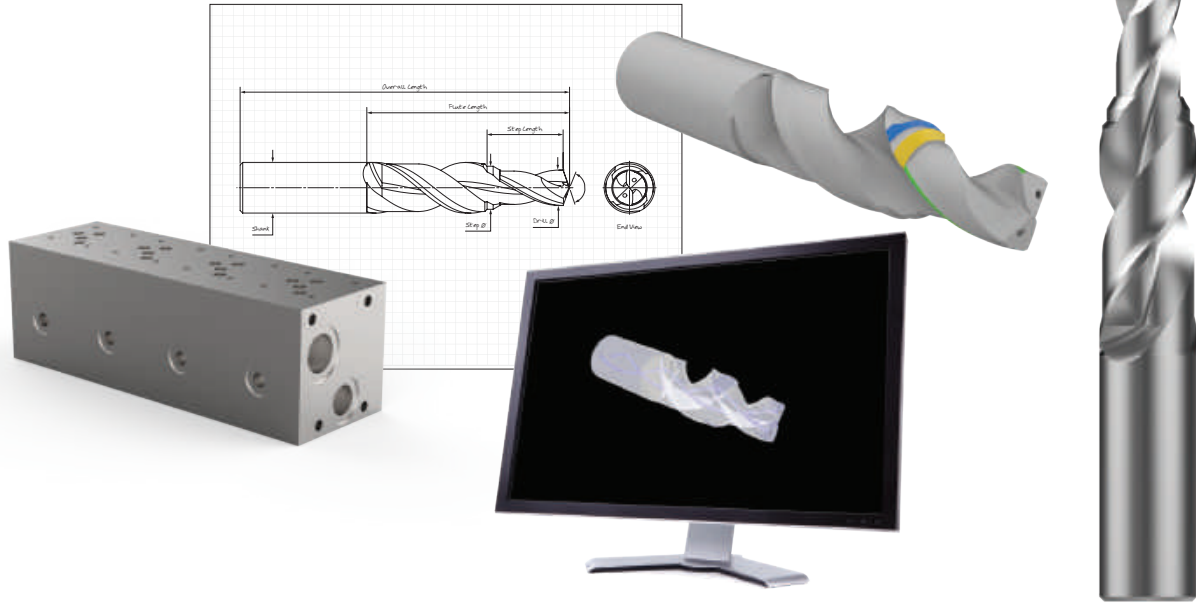

### The Challenge of CFRP Materials

Carbon fiber material is ideal for industries that require components with high strength and rigidity without increasing weight. In other words, these products need to be really strong and sturdy but also really light. For example, the aerospace industry revolves around aerodynamics, which is why carbon fiber is utilized to increase the quality of aerospace components without increasing the weight.

Many other metals are composed of uniform properties that are the same in every direction. Carbon fiber, on the other hand, is made of fabrics that are specifically positioned in different directions. This configuration increases the strength and rigidity of the material, but it also makes carbon fiber much more difficult to drill.

### Results When Drilling Aerospace-Grade Carbon Fiber

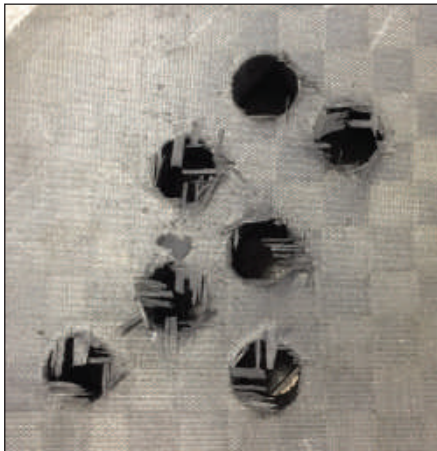

Holes drilled with CVD drill insert



Holes drilled with PCD tooling

### Just Look at That!

These images tell the whole story. Check out the holes drilled by the PCD tooling versus the CVD insert. Notice the excessive delamination on the first group of holes. The PCD tooling avoids most delamination, resulting in an excellent hole in the difficult-to-drill carbon fiber material.

Carbon fiber has high strength that causes:

- Wear on the cutting tool
- Splintering/fraying of the hole

As you can see, the first test experienced these problems. The PCD tooling, however, successfully drilled clean holes.

## Insta-Quote™

Design Your Custom Tooling



Design your custom tooling and receive a drawing and quote...all within *minutes*.

[iq.alliedmachine.com](http://iq.alliedmachine.com)

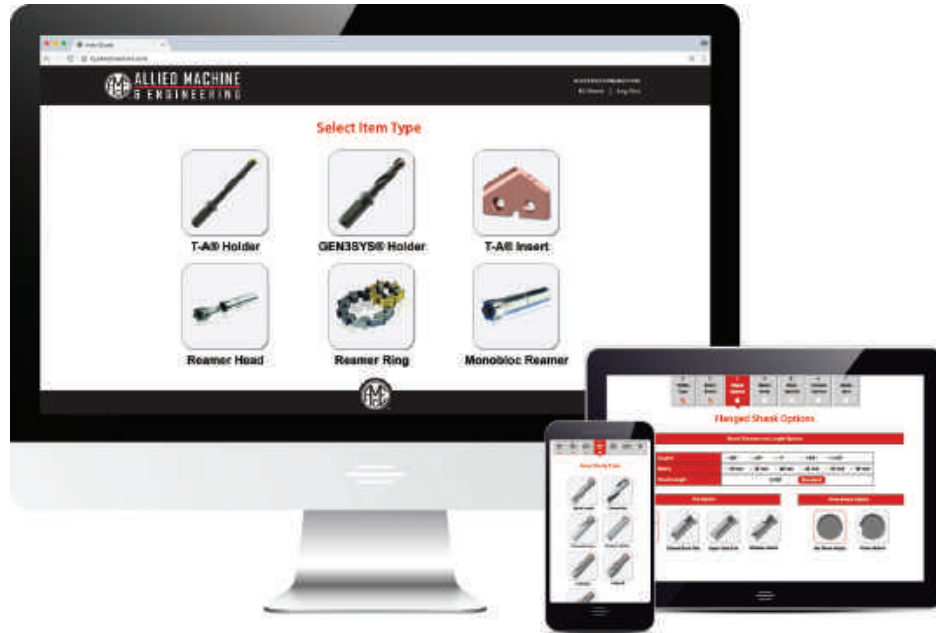

### Design Your Own Solutions

Insta-Quote is an online program that allows you to design and quote your own tooling in a matter of minutes. After you log in, Insta-Quote will guide you through the steps to gather all the necessary information and generate the solution you need. Within the system, you can choose from the following tools to design:

- T-A® Inserts
- T-A® Holders
- GEN3SYS® XT Holders

Along with designing these products as specials, Insta-Quote can also help you create your item number for ALVAN® Reamers. Because reamer item numbers do not follow the same method as Allied Machine's standard products, you must build your reamer item numbers. Insta-Quote can do that for you.

- Replaceable Head Style
- Monobloc Style
- Cutting Ring Style



Design anytime from anywhere.  
Available online 24/7.



# Insta-Quote™

## User Guide



### Where Do I Find Insta-Quote?

There are two ways to get to the Insta-Quote program. You can visit the Allied Machine homepage ([www.alliedmachine.com](http://www.alliedmachine.com)) and click on the Insta-Quote icon under the quick links menu (☰)

Or, you can simply go to [iq.alliedmachine.com](http://iq.alliedmachine.com) to access Insta-Quote directly.

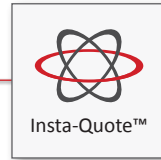

OR [iq.alliedmachine.com](http://iq.alliedmachine.com)

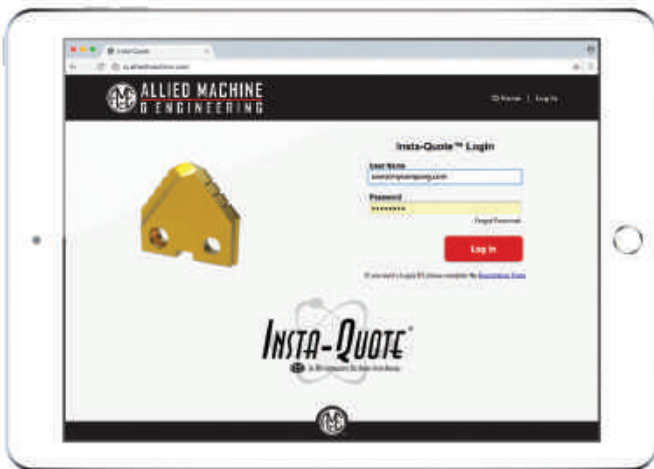

**1**

### Log In

Fill in "User Name" and "Password" and click the login button. If you do not have a login, just click the "Registration Form" option beneath the log in button and submit your registration.



**2**

### Select Activity

On this screen, you can choose to create a new tool, edit a previous tool, update your quote, or copy a previous item.

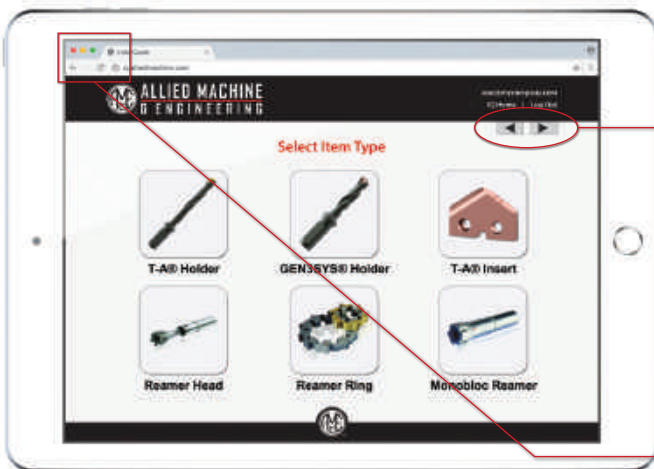

**3**

### Select Tool Type

Choose the type of special tool you would like to create. The options include T-A® inserts, T-A® holders, GEN3SYS® holders, replaceable head reamers, monobloc reamers, and cutting ring reamers.



### IMPORTANT:

The right and left arrows will navigate you through each step. **DO NOT** use the web browser's back and forward buttons; doing so may result in loss of progress.

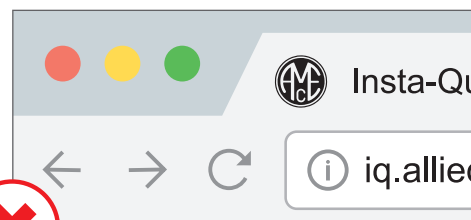

**Do not use the web browser's back and forward arrows**

**What is My Item Number?**

As soon as you select the type of product you want to design, Insta-Quote automatically generates the item number for your tool. The item number will appear at the top left-hand side of your screen.

**170209-547**

Year    Month    Day    Reference No.



**4 Shank Selection**  
Select the shank type you require and then click the right arrow button ► to proceed.

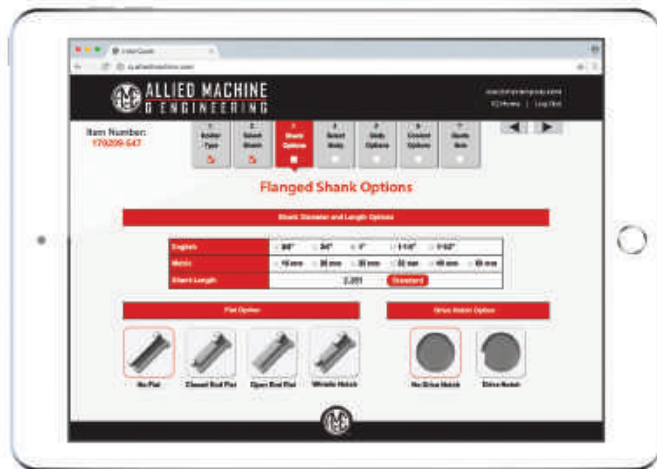

**5 Shank Options**  
After choosing the shank type, you will be provided with additional shank options (if applicable). Once your selections are made, click the right arrow button ► to proceed.

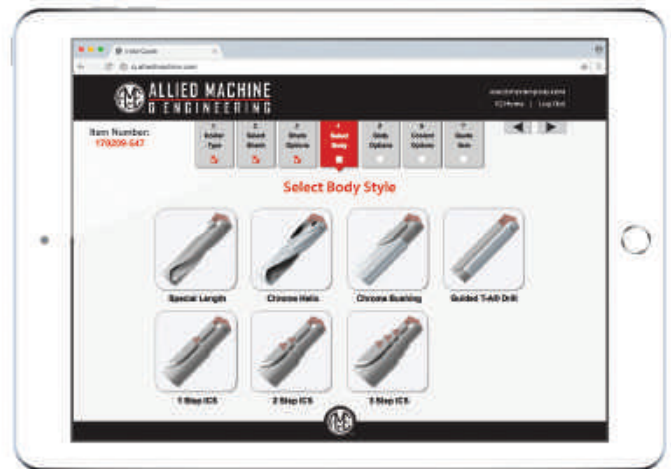

**6 Select Body Style**  
Choose the holder style you need, and then click the right arrow button ► to proceed.

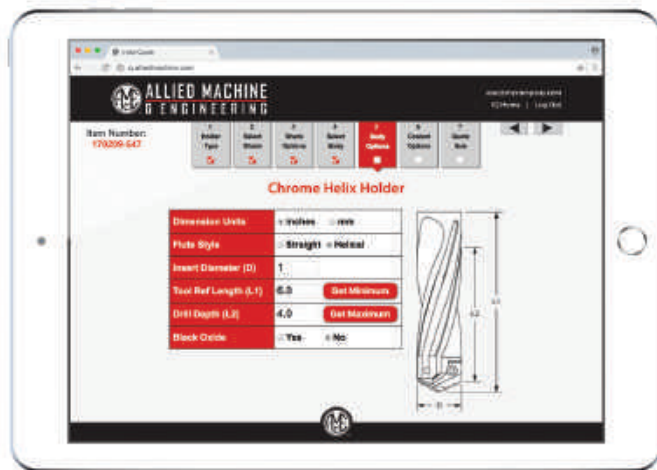

**7 Body Options**  
After choosing the holder style, you will be provided with additional holder options (if applicable). Once your selections are made, click the right arrow button ► to proceed.



**8 Coolant Options**  
On this screen you will select your coolant options. When finished, click the right arrow button ► to proceed.

A DRILLING  
B BORING  
C REAMING  
D BURNISHING  
E THREADING  
X SPECIALS

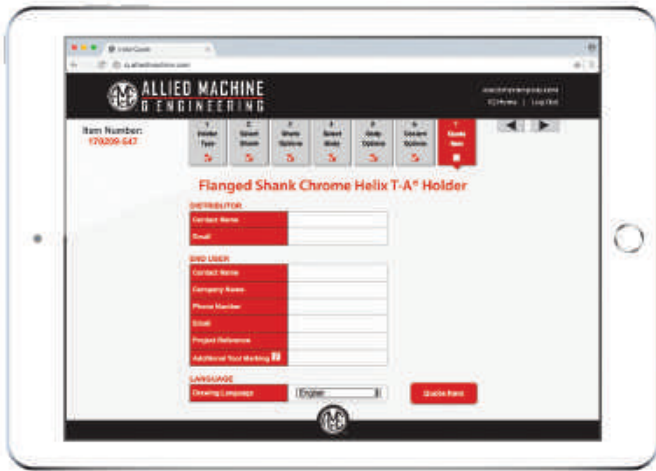

9

**Contact Information**

Complete the contact details and select a language for the drawing. Click the "Quote Item" button to proceed.

10

**Quote Your Item**

Once you have selected "Quote Item," a box will appear to let you know the estimated time remaining before your quote and drawing are created (typical wait time is less than 1 minute).

**NOTE:** Your pop-up blocker must be disabled in order to view the downloaded files.



120 Deeds Drive  
Dover, OH 44622  
P: +1.330.343.4283  
F: +1.330.602.3400  
www.alliedmachine.com

Date: 02/09/2017

Quotation Number:  
**N-012345-678910**

*Please reference the above number when placing an order*

---

Attn: Joe Thomas

Customer Account  
123 Holemaking Pkwy  
Suite 1000  
Dover OH 44622  
Phone: 330-343-4283  
Fax: 330-602-3400  
AMEC Rep: Harold Stokely

Customer Name: ABC Company  
Customer Contact: Joe Thomas  
Customer Item Reference N/A  
Email: joe@mycompany.com  
Phone: 3303303300

USA

---

This quotation is being offered based on the information that has been provided to AMEC. The price and manufacturability is subject to change based on the final design of the item.

DESCRIPTION	QTY	LIST PRICE EACH (U.S. \$)
#2 Series T-A <sup>®</sup> Chrome Helix Holder With 1.000" Drill Diameter, 5.860" Helical Flute, 4.00" Drill Depth, 1.000" Dia. By 2.281" Long Flanged Shank With No Flat With Through Shank Coolant, Per AMEC# 170210-523 Rev. 0	1	\$ 0.00
	2	\$ 0.00
	3	\$ 0.00
	4-5	\$ 0.00
	6-9	\$ 0.00
	10-14	\$ 0.00
	15-24	\$ 0.00
	25-49	\$ 0.00
	50+	\$ 0.00

**Allowable Quantity Variance Shipment Table**

Order Quantity	Variance Amount	Order Quantity	Variance Amount
1-9	+0/-0	150-299	+0/-3
10-49	+0/-1	300-499	+0/-5
50-149	+0/-2	500+	+0/-10

*\* Deviations with approval by the customer*

**WARNING For Deep Hole Drilling**

*After making the tool, please check the tool for any damage. Do not use the tool if it is damaged. If you find any damage, please contact your distributor or AMEC. Do not use the tool if it is damaged. If you find any damage, please contact your distributor or AMEC.*

This Document will serve as our official response. Please notify us if additional copies should be mailed.

- This quote is valid until 12/31/2018 unless you are sent a specific notification to the contrary.
- Scheduled lead time is based on availability of material at time of order. You will be notified within 3 business days of receipt of order, if a lead time change is required.
- Scheduled lead time starts upon receipt of order as well as customer approved AMEC drawing when appropriate.
- All special order cancellations are subject to a minimum of 10% cancellation charge. AMEC reserves the right to increase the cancellation charge as deemed necessary to cover costs associated with items being cancelled.

**ALLIED MACHINE & ENGINEERING CORP**  
This quote prepared by: *Insta-Quote*

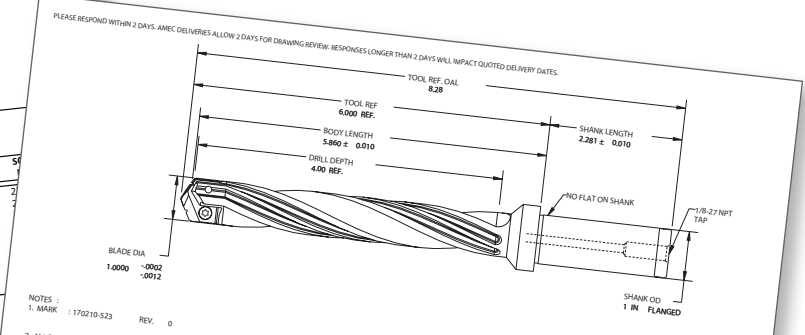

PLEASE RESPOND WITHIN 2 DAYS. AMEC DELIVERIES ALLOW 2 DAYS FOR DRAWING REVIEW. RESPONSES LONGER THAN 2 DAYS WILL IMPACT QUOTED DELIVERY DATES.

NOTES:  
1. MARK : 170210-523 REV. 0  
2. ALL DIMENSIONS NOT SPECIFIED ARE ALLIED MACHINE AND ENGINEERING CORP. STANDARDS.

THIS DRAWING IS PROVIDED TO ILLUSTRATE CONCEPT AND DIMENSIONS PRIOR TO ANY MANUFACTURING. BY SIGNING YOU ACCEPT RESPONSIBILITY FOR ANY MANUFACTURING. SPECIFICATIONS SHOWN ARE SUBJECTS OF WHERE THEY WERE OBTAINED.		DEVELOPED FOR DISTRIBUTOR : ABC Company CONTACT : Joe Thomas	
SIGNED: _____ DATE: _____		DO NOT SCALE FOR DIMENSIONS GENERAL TOLERANCES: DIM: X .X XX XXX XXXX DEC: 0.005 0.010 0.030 0.050 FRA: 1/16 1/8 3/16 1/4 ANG: 0.5 DIN: FQ DATE: 02/10/2017 SHEET 1 OF 1	
THIS DRAWING IS THE PROPERTY OF ALLIED MACHINE & ENGINEERING CORP. IT IS NOT TO BE COPIED OR TRANSMITTED IN ANY FORM OR BY ANY MEANS WITHOUT WRITTEN PERMISSION OF ALLIED MACHINE & ENGINEERING CORP.		TITLE: #2 SERIES T-A CHROME HELIX HOLDER WITH 1 IN DIA FLANGED SHANK WITH THROUGH SHANK COOLANT DWG NO: 170209-547 REV: 0	

The drawing contains all relevant dimensions. It must be signed before manufacturing can begin.  
**NOTE:** The drawing is a generic representation and is not to scale.

A DRILLING  
B BORING  
C REAMING  
D BURNISHING  
E THREADING  
X SPECIALS

# Insta-Quote™ Custom Tooling

## T-A® Inserts

A  
DRILLING  
B  
BORING  
C  
REAMING  
D  
URNISHING  
E  
HREADING  
X  
PECIALS



Special Angle



Double Angle



Spur Point

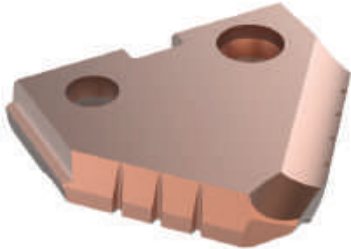

Spot and Chamfer



Step Insert



Flat Bottom



Ball Nose

Insta-Quote™ 

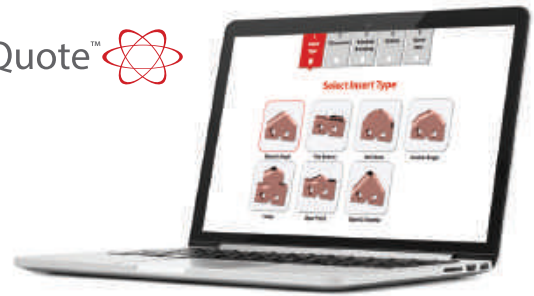



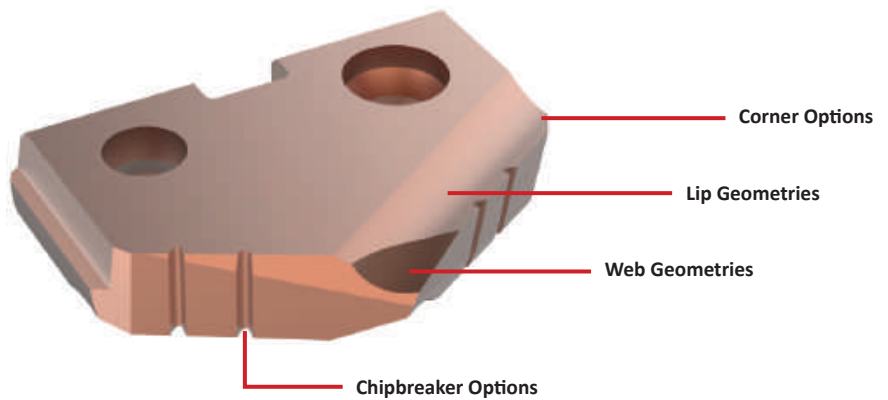

### Additional Features

Insta-Quote provides multiple options to enhance different areas of the insert. If you have questions about which options would most benefit your application, just give us a call. We'll be happy to provide in-depth explanations about how certain options can optimize your results.



Substrate Options
<b>HSS:</b> HSS, Super Cobalt, Premium Cobalt
<b>Carbide:</b> C1, C2, C3, C5

Coating Options			
<b>AM200®</b> 	<b>TiN</b> 	<b>TiAlN</b> 	<b>TiCN</b> 



## Insta-Quote™ Custom Tooling

### T-A® Holders



Chrome Helix



Chrome Bushing



 Guided Holder



One Step ICS



Two Step ICS



Three Step ICS



 Special Length

Insta-Quote™ 



### Additional Features

Insta-Quote provides multiple options to enhance different parts of the holder. If you have questions about which options would most benefit your application, just give us a call. We'll be happy to provide in-depth explanations about how certain options can optimize your results.

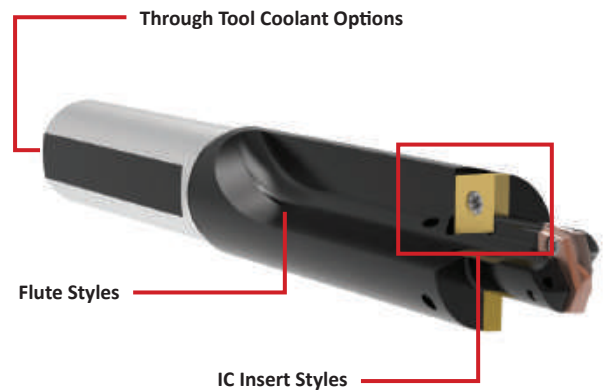

**⚠ WARNING** Refer to Speed and Feed charts for recommended adjustments to speeds and feeds. Refer to page X: 26 for deep hole drilling guidelines in this section of the catalog. Visit [www.alliedmachine.com/DeepHoleGuidelines](http://www.alliedmachine.com/DeepHoleGuidelines) for the most up-to-date information and procedures. Factory technical assistance is available for your specific applications through our Application Engineering Team.

# Insta-Quote™ Custom Tooling

## GEN3SYS® XT Holders

A DRILLING  
B BORING  
C REAMING  
D BURNISHING  
E THREADING  
X SPECIALS



Chrome Helix



Chrome Bushing



⚠ Special Length



One Step ICS



Two Step ICS



Three Step ICS

### Additional Features

Insta-Quote provides multiple options to enhance different parts of the holder. If you have questions about which options would most benefit your application, just give us a call. We'll be happy to provide in-depth explanations about how certain options can optimize your results.

Insta-Quote™

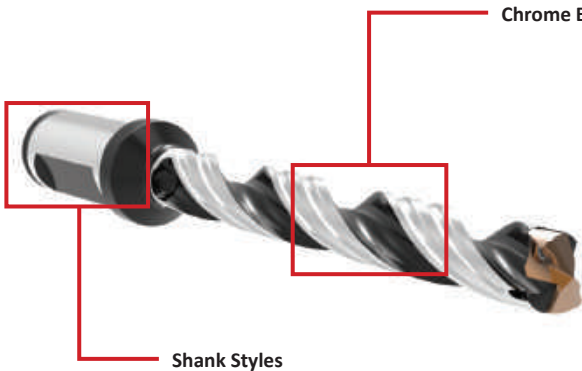
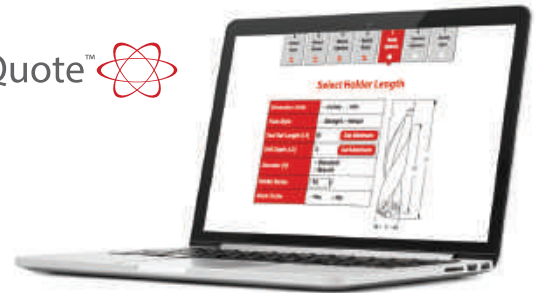

Chrome Bearing Areas

Shank Styles

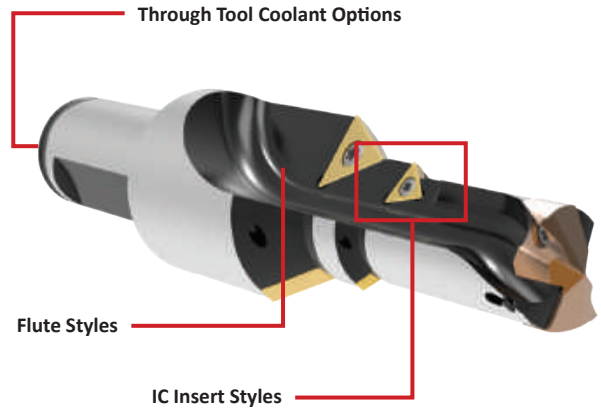

Through Tool Coolant Options

Flute Styles

IC Insert Styles

### Where are the Inserts?

Though Insta-Quote incorporates special designs for GEN3SYS XT holders, it does not include options for designing special GEN3SYS XT inserts. GEN3SYS XT holders utilize standard GEN3SYS XT inserts, which can be found in Section A20 of the product catalog.

If you need a special insert, or would simply like to discuss options for designing one to fit your application, please contact us and we can create a special design as an engineered special.

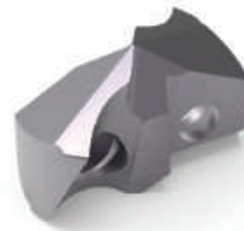

**Engineered Special**  
GEN3SYS XT insert designed for specific aerospace application

**⚠ WARNING** Refer to Speed and Feed charts for recommended adjustments to speeds and feeds. Refer to page X: 26 for deep hole drilling guidelines in this section of the catalog. Visit [www.alliedmachine.com/DeepHoleGuidelines](http://www.alliedmachine.com/DeepHoleGuidelines) for the most up-to-date information and procedures. Factory technical assistance is available for your specific applications through our Application Engineering Team.

## Insta-Quote™ Custom Tooling

### ALVAN® Reamers



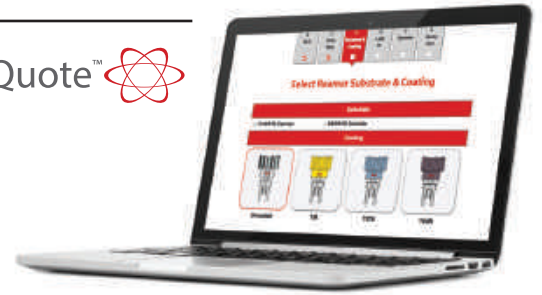

#### Use Insta-Quote to Build Your Part Numbers

Insta-Quote can help you find or build the ALVAN® Reamer item numbers you need along with the price and delivery of the items. It can also give you the recondition item and delivery. Just follow the steps, and Insta-Quote will guide you through the process.



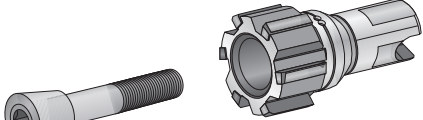
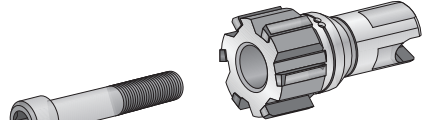
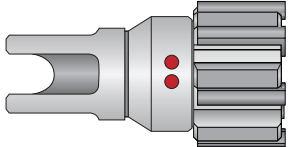
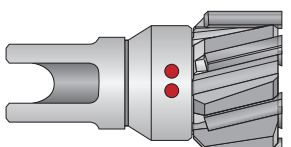

Insta-Quote™ 





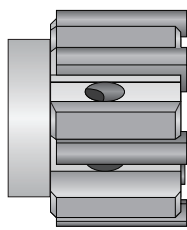
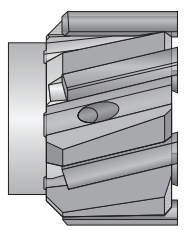

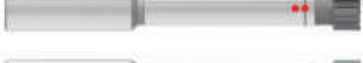
#### Replaceable Head Style

Diameter Options	Flute Options	Coating Options
 <p>Expandable Diameter</p>  <p>Fixed Diameter</p>	<p>Straight Flute</p>  <p>Left Hand Helical Flute</p> 	<p>Uncoated</p>  <p>TiN</p>  <p>TiAlN</p>  <p>TiCN</p> 

#### Monobloc Style

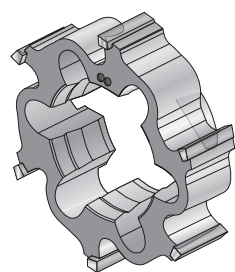
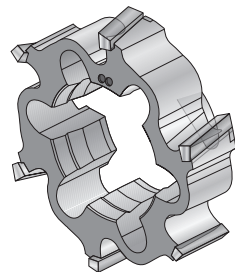
Flute Options	Coating Options
 <p>Straight Flute</p>  <p>Left Hand Helical Flute</p>	<p>Uncoated</p>  <p>TiN</p>  <p>TiAlN</p>  <p>TiCN</p> 

#### Cutting Ring Style

Flute Options	Coating Options
 <p>Straight Flute</p>  <p>Left Hand Helical Flute</p>	<p>Uncoated</p>  <p>TiN</p>  <p>TiAlN</p>  <p>TiCN</p> 

## Engineered Specials

### Insert Designs

#### OUR SOLUTION

##### T-A® PCD Drill Insert



- C3 carbide substrate increases tool life
- PCD tip is specifically designed for carbon reinforced polymer (CFRP) material
- Notch Point® geometry, special corner clip, and drill point angle help minimize delamination upon exiting the hole

#### YOUR ADVANTAGE

Take control of carbon fiber reinforced polymer applications. The T-A PCD drill insert can provide the hole quality you need to produce successful quality parts and reduce scrap.

#### Polycrystalline Diamond Insert

What allows the polycrystalline diamond (PCD) insert to generate such high success in aerospace carbon fiber is the sharp cutting edge that provides clearance cutting and reduces delamination. The PCD wafers improve the wear resistance.

While other tools encounter massive tearing when exiting the hole in carbon fiber, the PCD insert geometry, along with precise OD corner prep and Notch Point® technology, encounters minimal delamination. This produces a near-perfect, tight tolerance and smooth hole (see the images below).

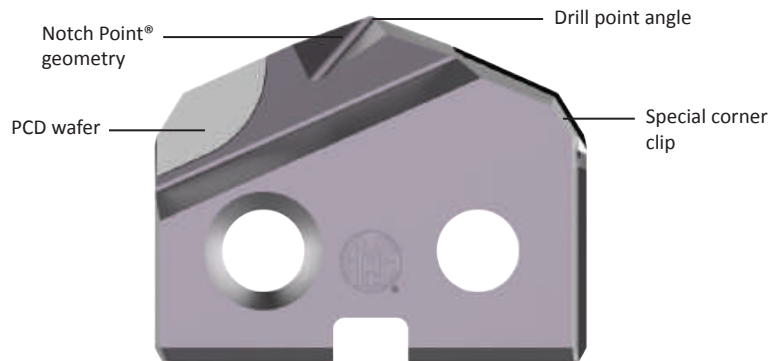

#### The Proof is in the Numbers

See the following results from a customer who was experiencing difficulty when drilling CFRP material:

INCREASED tool life by **80%**

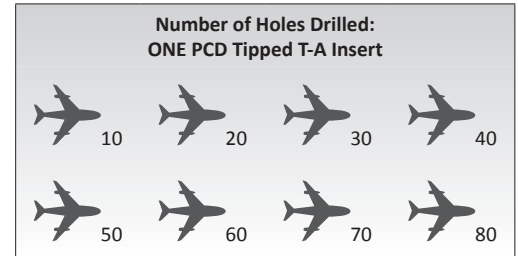
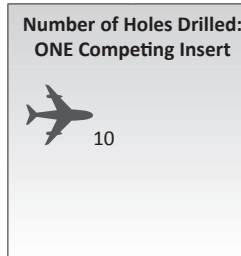

#### Infinite Solutions

Though Insta-Quote™ and i-Form are incredible special tooling systems, some applications require a deeper level of engineering to accomplish the optimal results. No matter what the application may be, Allied Machine engineers have the knowledge, experience, and expertise to design and develop a special product to exceed your expectations.

Engineered Specials are not limited to T-A® or GEN3SYS® XT products. In fact, Engineered Specials can be created for most products offered by Allied Machine, including APX Drill, Opening Drill®, ASC 320®, AccuThread™ 856, Wohlhaupter® boring products, and many other product families.



Back Chamfer without Chip Breakers



Back Chamfer with Chip Breakers



Non-Center Cutting and Chamfer



Special Inverted Coring Geometry



Flat Fottom with Pilot, Corner Radius, and Chamfer



Multiple Step



Special Step



Special Point



Special Counter-bore Step



Special Corner Radius

## Engineered Specials

### Featured Design | GEN3SYS® XT Vacuum Drill



The GEN3SYS XT® Vacuum Drill allows you to reap the productivity benefits of the GEN3SYS® XT outside of a fixed-position machine tool. The Vacuum Drill technology attaches to a hose to remove material that flows through the internal flute of the drill. This versatile ability allows the drilling process to move from location to location, performing operations on large components.

The design of the GEN3SYS® XT insert increases penetration rates, which can lower your production time and decrease operation costs. Available in multiple material-specific geometries, the GEN3SYS® XT has a solution for most applications.

A  
DRILLING  
B  
BORING  
C  
REAMING  
D  
BURNISHING  
E  
THREADING  
X  
SPECIALS

#### OUR SOLUTION

##### GEN3SYS® XT Vacuum Drill



- Spent coolant and chips are evacuated through an internal flute
- Guided body diameter to run through a drill bushing
- Replaceable tip for quick and easy insert change

#### YOUR ADVANTAGE

The sealed vacuum system lets you move your drilling operations outside the confines of a machine, allowing you to increase productivity on massive components.

#### MATERIAL TIPS

##### Drilling in CFRP (Carbon Fiber Reinforced Polymer)

- These applications are run with the vacuum only (no coolant)
- Can be run with or without a micro peck cycle

##### Drilling in Metal

- These applications are run with the vacuum and coolant or mist
- Recommended to be run with a micro peck cycle

 Materials remain contained in a sealed vacuum system

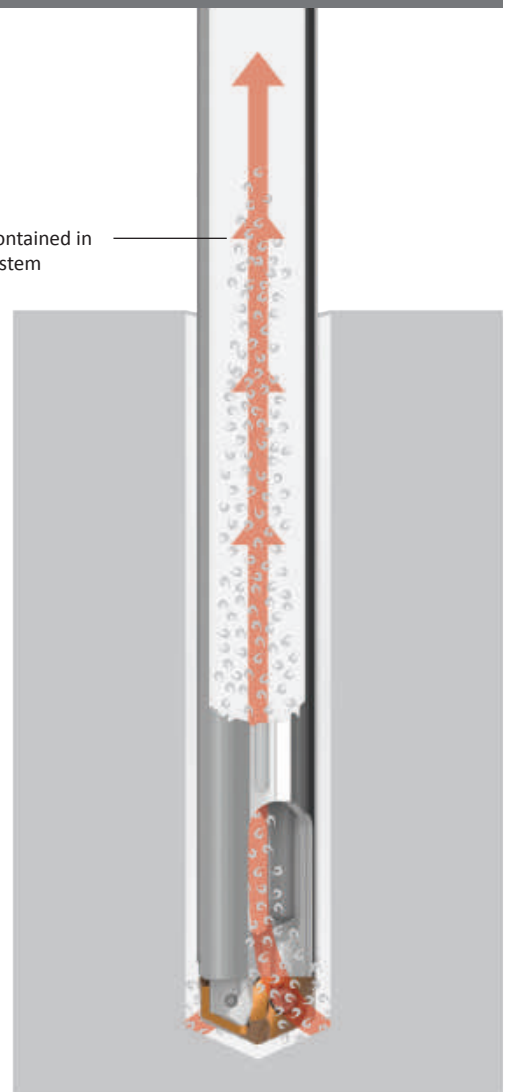

 The same holder can be used for a range of diameters

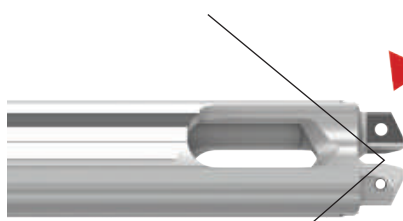

 The same holder can be used for different material-specific inserts

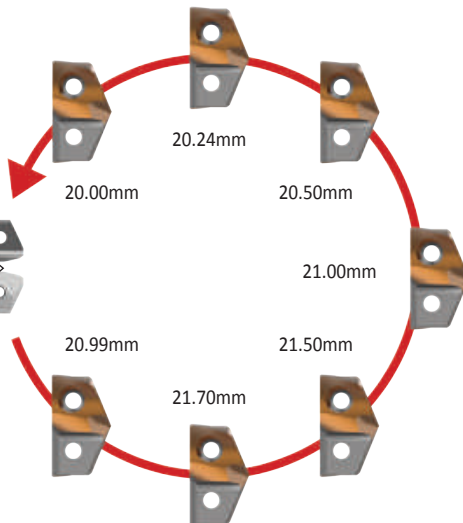

## Engineered Specials

Featured Design | T-A® Stealth Drill

A DRILLING  
B BORING  
C REAMING  
D BURNISHING  
E THREADING  
X SPECIALS



### T-A Stealth Drill Highlights

- 2 adjustable Torx® PLUS screw pins allow for diameter adjustment to reduce TIR
- Provides improved tool life and hole finish
- Guided wear pads improve hole straightness
- Coolant through design with multiple coolant outlets along the drill holder provides stability in deep hole drilling applications and also improves chip evacuation



Industry Application  
**Automotive**



Industry Application  
**Aerospace**

### Triple Coolant Outlets

- Additional coolant outlets help keep the holder straight and precise
- Longer holders experience and maintain increased stability in deeper holes

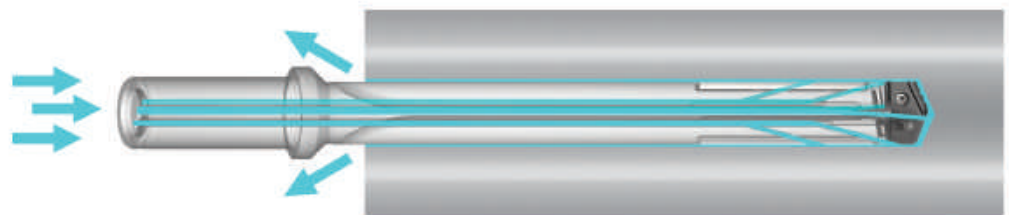

Locate the 2 adjustable Torx® PLUS screws (one on each side).



Loosen each screw.



Adjust insert position.

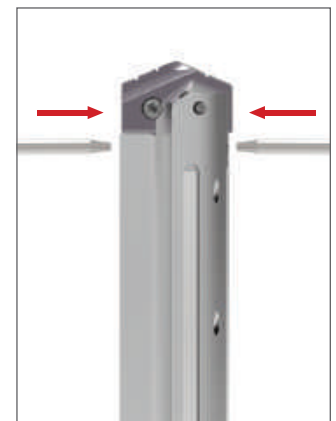

Tighten each screw.

### The Proof is in the Numbers

The following results came from a real-life application that utilized the T-A Stealth Drill. The customer was experiencing a high scrap rate and needed to find a solution to eliminate the problem.

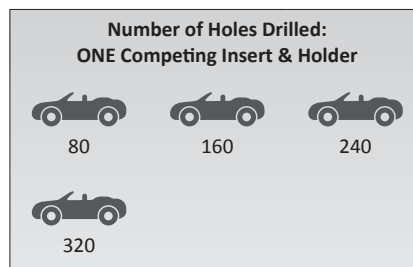

#### In this application, Allied Machine:

- Eliminated **\$240,000** in scrap per year
- Optimized the chip formation
- Enhanced the chip evacuation
- Provided excellent surface finish

**INCREASED** tool life by  
**280%**

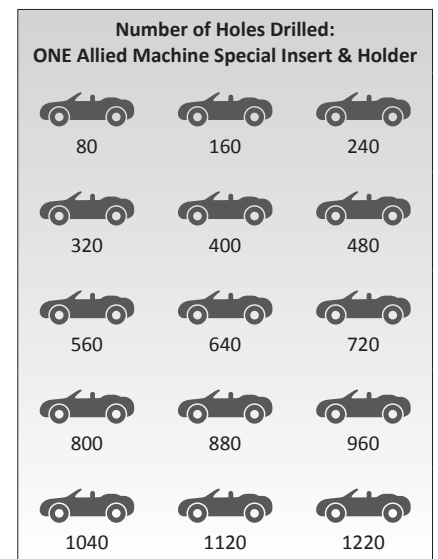

## Engineered Specials

### Success Stories

#### Real-Life Results

Below are five brief success stories. Each one provides an overview of specific situations when our special tooling achieved top-quality performance for our customers. For more success stories, or to read full in-depth case studies, go to [www.alliedmachine.com/RealLifeResults](http://www.alliedmachine.com/RealLifeResults).



Industry Application

#### Oil & Gas

##### Special AccuPort 432® Port Contour Cutter

*Hydraulic Manifolds*

- Eliminated multiple tools in the process
- Eliminated regrinds
- Improved performance in cross hole applications



Industry Application

#### Heavy Equipment

##### Special T-A® Holder & Insert

*Axle Shafts*

- 100% increase in tool life
- \$7,500 reduction in set-up costs
- Eliminated scrap that was caused by set-up issues



Industry Application

#### Firearms

##### i-Form Drill

*Barrel Nut*

- Eliminated three tools in the process
- Reduced cycle time by 25%
- Improved chip formation



Industry Application

#### Automotive

##### T-A® Rim Drill

*Aluminum Wheels*

- 50% increase in penetration rates
- 50% increase in tool life
- Eliminated regrinds



Industry Application

#### Aerospace

##### Special Carbide Clad T-A® Holder with Diamond Coated Insert

*Carbon Fiber Landing Arm*

- Eliminated delamination of carbon fiber
- 7x more tool life
- Special shank threads directly into drill unit for easy tool change



A

DRILLING

B

BORING

C

REAMING

D

BURNISHING

E

THREADING

X

SPECIALS

## Engineered Specials

### i-Form Custom Indexable Drill / Form Tool System

#### Any Way You Want It

What if you could utilize complex forms that only seem to be available as brazed or solid carbide tools? Allied Machine's i-Form custom indexable drill/form tool system allows for complex designs with a replaceable cutting edge. This will reduce set-up times and eliminate regrinds, allowing you to increase your productivity and reduce costs. Don't settle for being good when the possibility of being great is right in front of you.

This is just a small sample of what you can do.



**i-Form Holder  
with i-Form Inserts**



**Lug Hole T-A® Drill  
with i-Form Inserts**



**i-Form Drill for Facing Operations  
with ID-OD Chamfer**

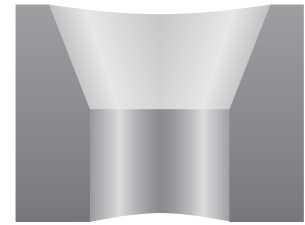
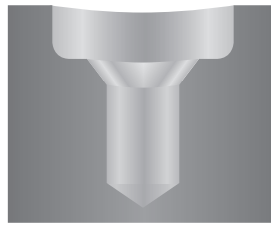
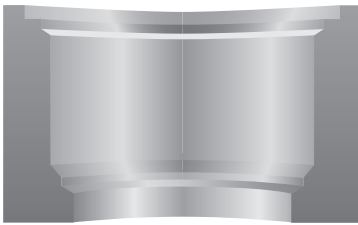

#### Design Complex Forms for ANY Hole Style

i-Form allows you to design complex forms for any style hole with increased productivity. The i-Form product line - both pilot inserts and form inserts - creates custom engineered forms that provide complex designs with replaceable cutting edges and improved consistency, all while outperforming brazed and solid carbide tooling. i-Form tools will increase your productivity, minimize set-up times, and eliminate regrind tool float and inconsistency.

- Holders have coolant through capabilities
- Holders can utilize standard inserts, Insta-Quote™ inserts, and/or special insert designs

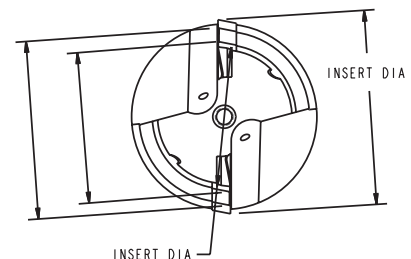
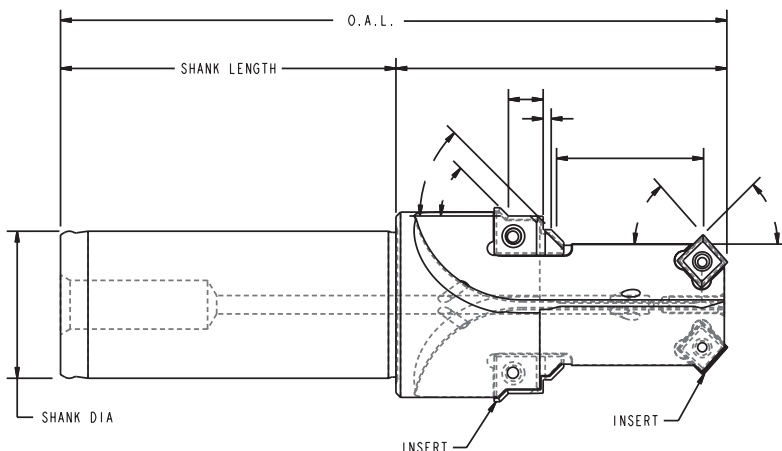



## Engineered Specials

### i-Form Custom Indexable Drill / Form Tool System



**GEN3SYS® XT Pilot Insert  
with i-Form Inserts**



**GEN3SYS® XT Pilot Insert  
with i-Form Inserts**



**GEN3SYS® XT Back Chamfer Insert  
with i-Form Inserts**



**T-A® Flat Bottom Form Drill  
with i-Form Inserts**



**T-A® ICS Drill  
with i-Form Inserts**



**T-A® Pilot Insert  
with i-Form Inserts**



**Square QDSI 34® Inserts  
with i-Form Inserts**



**3 Flute IC Drill  
with i-Form Inserts**



**i-Form Holder  
with i-Form Inserts**



**AccuPort 432® Drill  
with Special T-A® Form Insert**



**T-A 2 Step IC Drill  
with i-Form Inserts**



**Special Core Drill  
with i-Form Inserts**

A

DRILLING

B

BORING

C

REAMING

D

BURNISHING

E

THREADING

X

SPECIALS

## Engineered Specials

Special Designs | T-A® Products

A  
DRILLING  
B  
BORING  
C  
REAMING  
D  
BURNISHING  
E  
THREADING  
X  
SPECIALS



**T-A IC Drill  
with Back Chamfer Insert**



**T-A 1 Step Stub Length**



**T-A IC Drill**



**T-A 2 Step IC Drill**



**T-A Counter Bore Tool  
with Micro Adjustable Cartridge**



**T-A Form Drill  
with Adjustable Cartridge**



**T-A Multiple Step Drill  
with Adjustable Cartridge**



**T-A Large Diameter  
Multiple Step IC Drill**



**T-A Deburr Drill**



**T-A IC Drill  
with Customer Defined Shank**



**T-A Deep Hole Drill  
with Customer Defined Design**



**T-A Chrome Bearing Drill  
with Customer Defined Shank**



**T-A 1 Step IC Drill  
with Flat Bottom Insert**



**T-A Form Drill**



**T-A Drill  
with Special Holder and Insert Design**

## Engineered Specials

Special Designs | Other Products



**Special BT-A Drill  
with Internal Thread**



**Special BT-A Drill**



**Special BT-A Drill**



**APX Drill  
with Carbide Clad Guides**



**APX Drill  
with 1 Step Design**



**APX Drill  
with HSK Shank**



**Opening Drill®  
with Special Diameter**



**Special Core Drill  
with 2 Step Design**



**ICS Drill  
with Adjustable Cartridge**



**Superion™ Solid Carbide  
with AM200® Coating**



**AccuThread™ 856  
with Through Coolant**



**AccuPort 432®  
Special Length**



**ALVAN® Ring Style Reamer  
with Special Length**



**GEN3SYS® XT  
with Morse Taper Shank**



**GEN3SYS® XT  
with IC Inserts and Special Body**

A

DRILLING

B

BORING

C

REAMING

D

BURNISHING

E

THREADING

X



SPECIALS

## QDSI 34® Inserts

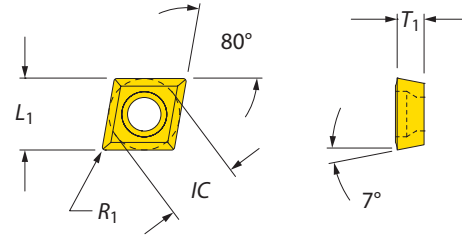
80° Diamond | 55° Diamond





### 80° Diamond Inserts

Imperial (inch)				Metric (mm)					ANSI Designation		
IC	L <sub>1</sub>	T <sub>1</sub>	R <sub>1</sub>	IC	L <sub>1</sub>	T <sub>1</sub>	R <sub>1</sub>				
0.250	0.249	0.094	0.008	6.35	6.32	2.39	0.20	<b>CCGT-060202</b>	CCGT 2(1.5)0.5	7256-IP8-1	8IP-8
0.250	0.247	0.094	0.016	6.35	6.28	2.39	0.40	<b>CCMT-060204</b>	CCMT 2(1.5)1	7256-IP8-1	8IP-8
0.250	0.244	0.094	0.031	6.35	6.21	2.39	0.79	<b>CCMT-060208</b>	CCMT 2(1.5)2	7256-IP8-1	8IP-8
0.250	0.244	0.156	0.031	6.35	6.21	3.96	0.79	<b>CCGT-06T308</b>	CCGT 2(2.5)2	7256-IP8-1	8IP-8
0.375	0.374	0.156	0.008	9.53	9.49	3.96	0.20	<b>CCGT-09T302</b>	CCGT 3(2.5)0.5	7359-IP15-1	8IP-15
0.375	0.372	0.156	0.016	9.53	9.46	3.96	0.40	<b>CCMT-09T304</b>	CCMT 3(2.5)1	7359-IP15-1	8IP-15
0.375	0.369	0.156	0.031	9.53	9.39	3.96	0.79	<b>CCMT-09T308</b>	CCMT 3(2.5)2	7359-IP15-1	8IP-15
0.500	0.497	0.188	0.016	12.70	12.63	4.76	0.40	<b>CCMT-120404</b>	CCMT 431	745105-IP20-1	8IP-20
0.500	0.494	0.188	0.031	12.70	12.56	4.76	0.79	<b>CCMT-120408</b>	CCMT 432	745105-IP20-1	8IP-20

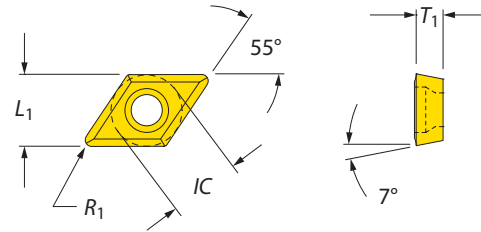
**NOTE:** QDSI 34 inserts are utilized only in special ICS holders. Speeds and feeds for QDSI 34 inserts are determined by drill insert.



### 55° Diamond Inserts

Imperial (inch)				Metric (mm)					ANSI Designation		
IC	L <sub>1</sub>	T <sub>1</sub>	R <sub>1</sub>	IC	L <sub>1</sub>	T <sub>1</sub>	R <sub>1</sub>				
0.250	0.243	0.094	0.008	6.35	6.18	2.39	0.008	<b>DCGT-070202</b>	DCGT 2(1.5)0.5	7256-IP8-1	8IP-8
0.250	0.237	0.094	0.016	6.35	6.01	2.39	0.016	<b>DCMT-070204</b>	DCMT 2(1.5)1	7256-IP8-1	8IP-8
0.250	0.223	0.094	0.031	6.35	5.67	2.39	0.031	<b>DCMT-070208</b>	DCMT 2(1.5)2	7256-IP8-1	8IP-8
0.375	0.362	0.156	0.016	9.53	9.19	3.96	0.016	<b>DCMT-11T304</b>	DCMT 3(2.5)1	7359-IP15-1	8IP-15
0.375	0.348	0.156	0.031	9.53	8.85	3.96	0.031	<b>DCMT-11T308</b>	DCMT 3(2.5)2	7359-IP15-1	8IP-15



**NOTE:** QDSI 34 inserts are utilized only in special ICS holders. Speeds and feeds for QDSI 34 inserts are determined by drill insert.

## QDSI 34® Inserts

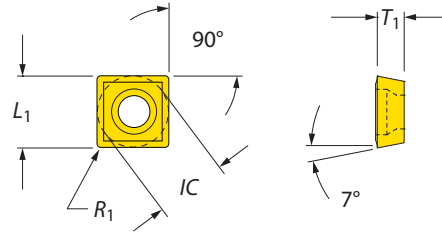
Square | 60° Triangle





### Square Inserts

Imperial (inch)				Metric (mm)					ANSI Designation		
IC	L <sub>1</sub>	T <sub>1</sub>	R <sub>1</sub>	IC	L <sub>1</sub>	T <sub>1</sub>	R <sub>1</sub>				
0.375	0.375	0.156	0.016	9.53	9.53	3.96	0.40	<b>SCMT-09T304</b>	SCMT 3(2.5)1	7359-IP15-1	8IP-15

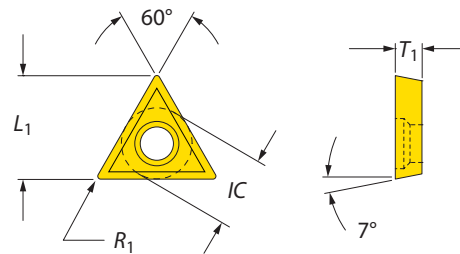
**NOTE:** QDSI 34 inserts are utilized only in special ICS holders. Speeds and feeds for QDSI 34 inserts are determined by drill insert.



### 60° Triangle Inserts

Imperial (inch)				Metric (mm)					ANSI Designation		
IC	L <sub>1</sub>	T <sub>1</sub>	R <sub>1</sub>	IC	L <sub>1</sub>	T <sub>1</sub>	R <sub>1</sub>				
0.156	0.259	0.078	0.008	3.97	6.58	1.98	0.20	<b>TCGT-06T102</b>	TCGT 1.2(1.2)0.5	724-IP6-1	8IP-6
0.156	0.248	0.078	0.016	3.97	6.29	1.98	0.40	<b>TCGT-06T104</b>	TCGT 1.2(1.2)1	724-IP6-1	8IP-6
0.156	0.225	0.078	0.031	3.97	5.71	1.98	0.79	<b>TCGT-06T108</b>	TCGT 1.2(1.2)2	724-IP6-1	8IP-6
0.219	0.367	0.094	0.008	5.65	9.33	2.39	0.20	<b>TCGT-090202</b>	TCGT 1.8(1.5)0.5	7225-IP7-1	8IP-7
0.219	0.356	0.094	0.016	5.65	9.04	2.39	0.40	<b>TCGT-090204</b>	TCGT 1.8(1.5)1	7225-IP7-1	8IP-7
0.219	0.333	0.094	0.031	5.65	8.46	2.39	0.79	<b>TCGT-090208</b>	TCGT 1.8(1.5)2	7225-IP7-1	8IP-7
0.250	0.422	0.094	0.008	6.35	10.71	2.39	0.20	<b>TCGT-110202</b>	TCGT 2(1.5)0.5	7256-IP8-1	8IP-8
0.250	0.410	0.094	0.016	6.35	10.42	2.39	0.40	<b>TCMT-110204</b>	TCMT 2(1.5)1	7256-IP8-1	8IP-8
0.250	0.387	0.094	0.031	6.35	9.84	2.39	0.79	<b>TCMT-110208</b>	TCMT 2(1.5)2	7256-IP8-1	8IP-8
0.375	0.627	0.156	0.016	9.53	15.92	3.96	0.40	<b>TCMT-16T304</b>	TCMT 3(2.5)1	7359-IP15-1	8IP-15
0.375	0.604	0.156	0.031	9.53	15.34	3.96	0.79	<b>TCMT-16T308</b>	TCMT 3(2.5)2	7359-IP15-1	8IP-15
0.500	0.820	0.188	0.031	12.70	20.83	4.76	0.79	<b>TCGT-220408</b>	TCGT 432	745105-IP20-1	8IP-20

**NOTE:** QDSI 34 inserts are utilized only in special ICS holders. Speeds and feeds for QDSI 34 inserts are determined by drill insert.

A DRILLING  
B BORING  
C REAMING  
D BURNISHING  
E THREADING  
X SPECIALS

# Special Tooling

## Complete Your Design

### Show Us What You Need

These pages have been included so you can assist us with defining your special tooling requirements.

- Select a Shank (1 - 6), or define Shank 7
- Indicate if the shank will be used with or without a Rotary Coolant Adapter (RCA)

We ask that you define your hole profile and offer an example of a tool form to help us with the design process. Tools 1 - 5 cover only a small portion of our capabilities, so feel free to use your imagination. Please scan these pages, record your information in the boxes on the next page, and email the information for our quickest response.

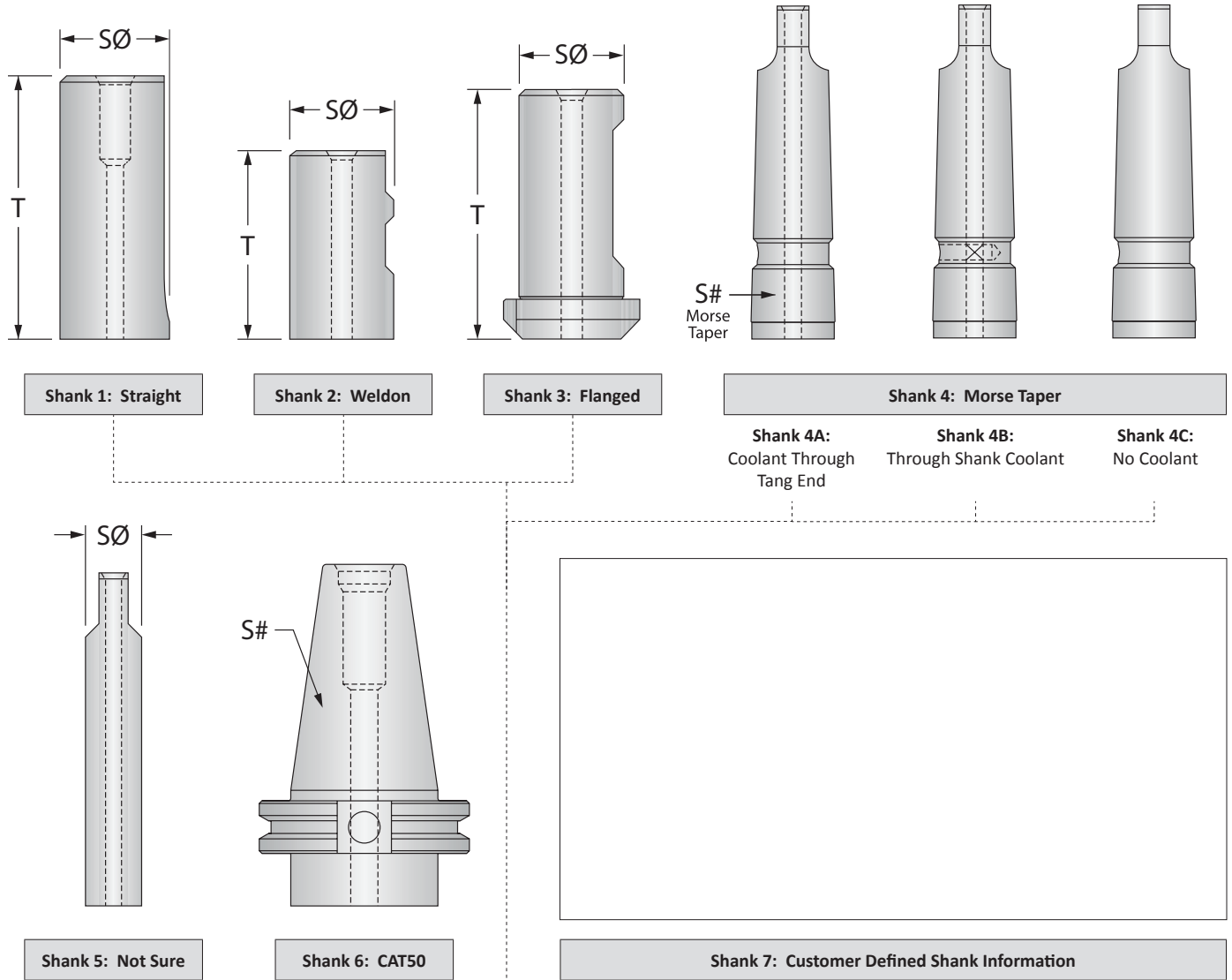

Shank	SØ	S#	T	RCA
4A (EXAMPLE)	-	4MT	-	YES <input checked="" type="radio"/> NO
				YES / NO
				YES / NO
				YES / NO

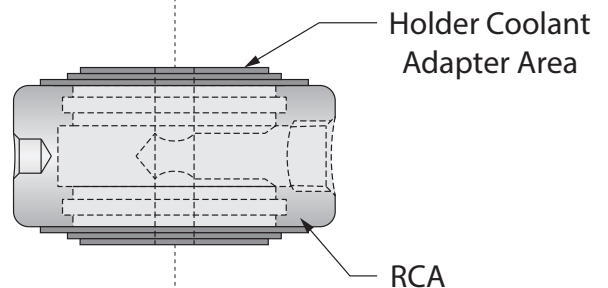

A  
DRILLING  
B  
BORING  
C  
REAMING  
D  
BURNISHING  
E  
THREADING  
X  
SPECIALS

**Tool 1**

- Carbide Clad
- Chrome Plate
- Helical Flute
- Straight Flute

**Tool 2**

- Helical Pilot
- Chrome Pilot

**Tool 3**

- Helical Flute
- Straight Flute

**Tool 4**

- Helical Pilot
- Chrome Pilot

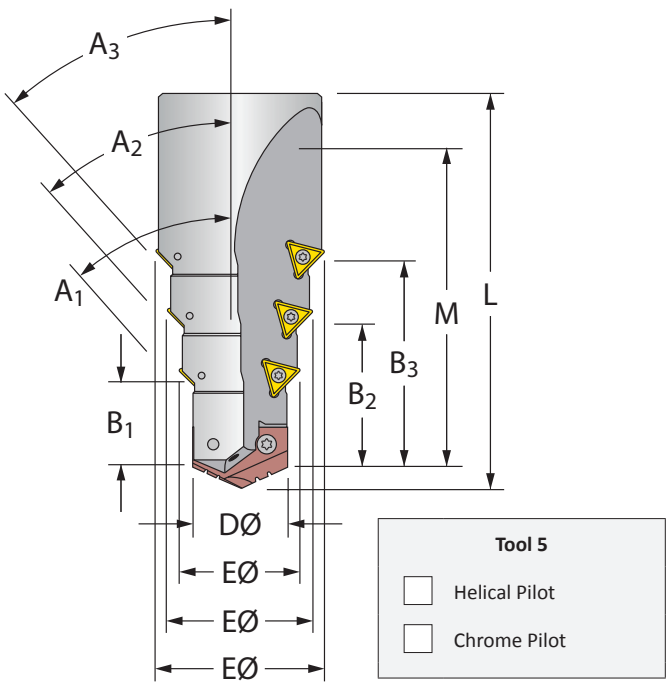
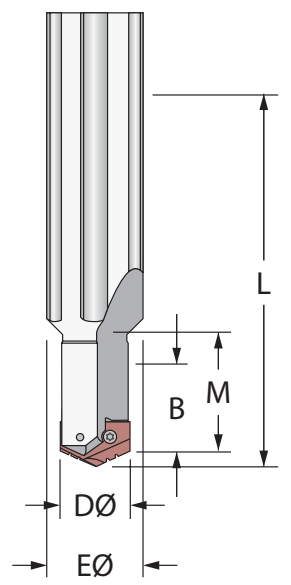
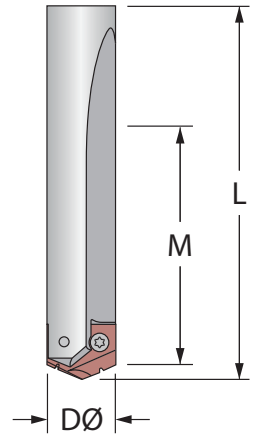
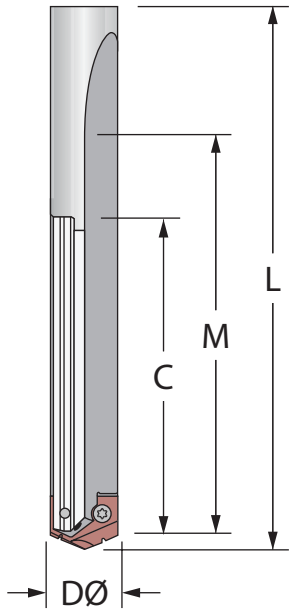
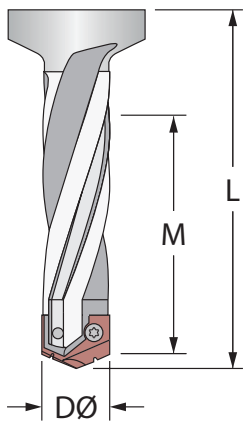

**Tool 5**

- Helical Pilot
- Chrome Pilot

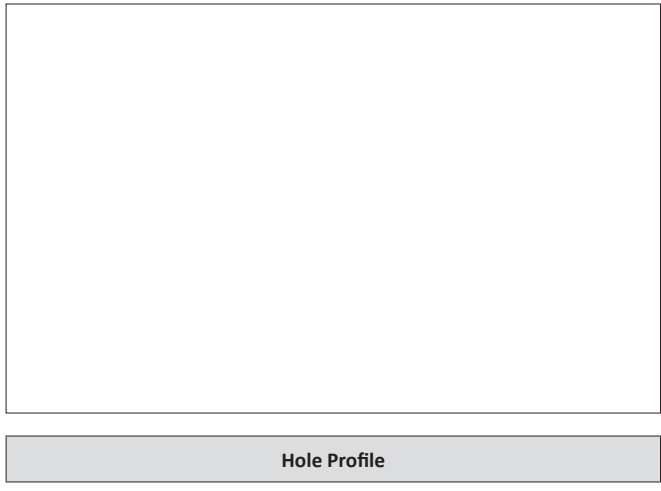

**Please email or fax your design to:**  
 Application Engineering Department  
 P: 800.321.5537  
 F: 330.343.7666  
 E: aesupport@alliedmachine.com

Item	Tool	A <sub>1</sub>	A <sub>2</sub>	A <sub>3</sub>	B <sub>1</sub>	B <sub>2</sub>	B <sub>3</sub>	C	D Ø	E Ø	F Ø	G	L	M
EXAMPLE	5	30°	-	-	1.00	-	-	0.25	0.620	1.25	-	-	4.50	3.00

Customer Signature: \_\_\_\_\_ Date: \_\_\_\_\_

Please be sure to include shank and coolant information from the previous page when sending tool designs

A DRILLING  
 B BORING  
 C REAMING  
 D BURNISHING  
 E THREADING  
 X SPECIALS

## Deep Hole Drilling Guidelines

For Lengths Greater Than 9xD (including Extended, Long, XL, 3XL, and Special Length)

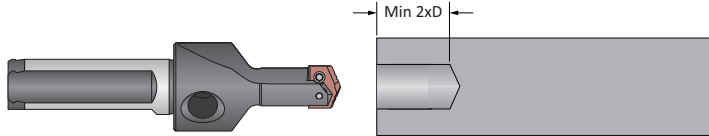
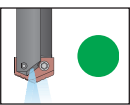
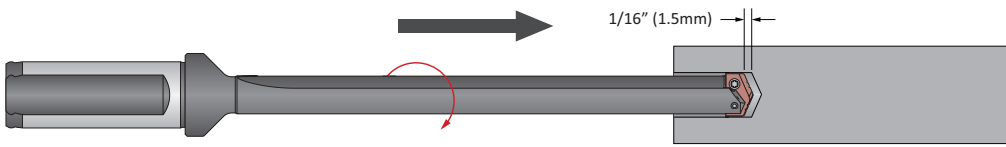
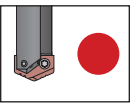
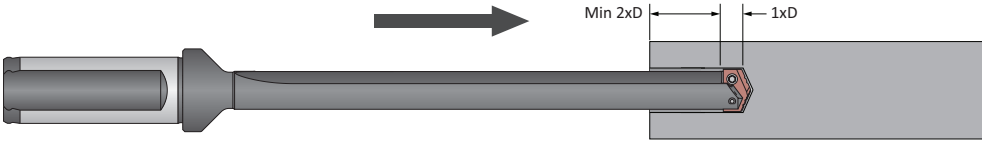
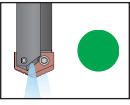
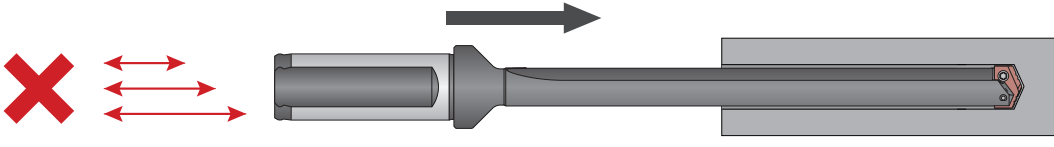
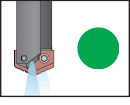
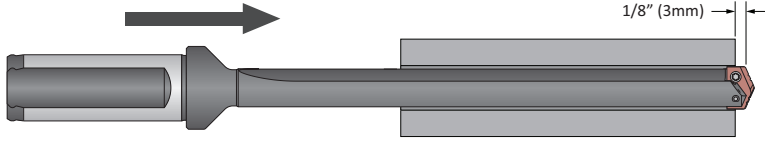
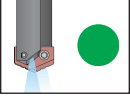
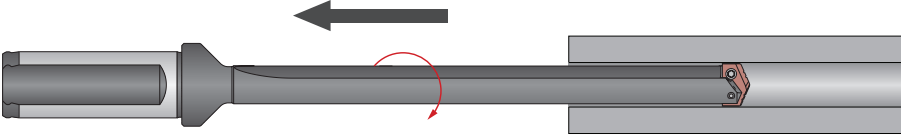
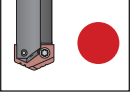
A DRILLING	<p><b>1. Pilot Hole</b> 100 % RPM 100% IPR (mm/rev)</p> <p>Establish the pilot hole using the same diameter short drill to a depth of 2xD minimum. Utilize a pilot drill with the same or larger included point angle.</p>  <p><b>Coolant ON</b></p> 
B BORING	<p><b>2. Feed-in</b> 50 RPM max 12 IPM (300 mm/min)</p> <p><b>!</b> Feed the longer drill within 1/16" (1.5mm) short of the established pilot hole bottom at a <b>maximum of 50 RPM</b> and 12 IPM (300 mm/min) feed rate.</p>  <p><b>Coolant OFF</b></p> 
C REAMING	<p><b>3. Deep Hole Transition Drilling</b> 50 % RPM 75% IPR (mm/rev)</p> <p>Drill additional 1xD past the bottom of the pilot hole at 50% reduction of recommended speed and 25% reduction of recommended feed. Minimum of 1 second dwell is required to meet full speed before feeding.</p>  <p><b>Coolant ON</b></p> 
D BURNISHING	<p><b>4. Deep Hole Drilling - Blind</b> 100% RPM 100% IPR (mm/rev)</p> <p>Drill to full depth at recommended speed and feed for longer drill according to Allied speed and feed charts. <b>No peck cycle recommended.</b></p>  <p><b>Coolant ON</b></p> 
E THREADING	<p><b>5. Deep Hole Drilling - at Breakout</b> 50% RPM 75% IPR (mm/rev)</p> <p><b>For through holes only:</b> Reduce speed by 50% and feed by 25% prior to breakout. Do not breakout more than 1/8" (3mm) past the full diameter of the drill.</p>  <p><b>Coolant ON</b></p> 
X SPECIALS	<p><b>6. Drill Retract</b> 50 RPM max</p> <p><b>!</b> Reduce speed to a <b>maximum of 50 RPM</b> before retracting from the hole.</p>  <p><b>Coolant OFF</b></p> 

**1. WARNING** Tool failure can cause serious injury. To prevent:

- When using holders without support bushing, use a short holder to establish an initial hole that is a minimum of 2 diameters deep.
- Do not rotate tool holders more than 50 RPM unless it is engaged with the workpiece or fixture.

Visit [www.alliedmachine.com/DeepHoleGuidelines](http://www.alliedmachine.com/DeepHoleGuidelines) for the most up-to-date information and procedures. Factory technical assistance is available for your specific applications through our Application Engineering Team.





Part No.	Page
<b>0</b>	
02B.40...	C: 56
02B.45...	C: 56
02B.50...	C: 56
0050GA...	B20: 4, B20: 10
0060GA...	B20: 4, B20: 10
0080GA...	B20: 4, B20: 10
0100GA...	B20: 4, B20: 10
0110GA...	B20: 4, B20: 10
0120HA...	B20: 4, B20: 10
0140HA...	B20: 4, B20: 10
0160HA...	B20: 4, B20: 10
0180HA...	B20: 4, B20: 10
0200HA...	B20: 4, B20: 10
0250B...	B20: 5, B20: 11, B20: 28, B20: 31, B20: 35
0312B...	B20: 5, B20: 11, B20: 28, B20: 31, B20: 35
0365HM...	B20: 5, B20: 28, B20: 31
0375B...	B20: 5, B20: 11, B20: 28, B20: 31, B20: 35
0425BHM...	B20: 35
0437B...	B20: 5, B20: 11, B20: 28, B20: 31, B20: 35
0500B...	B20: 5, B20: 11, B20: 28, B20: 31
0500BCH...	B20: 32
0500D...	B20: 35, B20: 39, B20: 43
0550BHM...	B20: 5, B20: 28, B20: 31, B20: 35
0625BCS...	B20: 5, B20: 29, B20: 31, B20: 36
0688CHM...	B20: 35
0750D...	B20: 35, B20: 39, B20: 43
0750DCH...	B20: 37
0832DHM...	B20: 35, B20: 39, B20: 43
0875DCS...	B20: 36, B20: 40, B20: 44
1000D...	B20: 35
1250D...	B20: 35
<b>1</b>	
1000D...	B20: 39, B20: 43
1000ECH...	B20: 41
1250D...	B20: 39, B20: 43
1500FCH...	B20: 45
10214...	A40: 7
10215...	A40: 7
1021A...	A40: 6
1021N...	A40: 6
1021T...	A40: 6
1022A...	A40: 11
1022A...	A40: 10

Part No.	Page
1022N...	A40: 10
1022T...	A40: 10
10234...	A40: 15
10235...	A40: 15
1023A...	A40: 14
1023N...	A40: 14
1023T...	A40: 14
10244...	A40: 19
10245...	A40: 19
1024A...	A40: 18
1024N...	A40: 18
1024T...	A40: 18
1024U...	A40: 18, A40: 38
10254...	A40: 23
10255...	A40: 23
1025A...	A40: 22
1025N...	A40: 22
1025T...	A40: 22
1025U...	A40: 22, A40: 38
10264...	A40: 27
10265...	A40: 27
1026A...	A40: 26
1026N...	A40: 26
1026T...	A40: 26
1026U...	A40: 26, A40: 38
1027A...	A40: 31
10275...	A40: 31
1027A...	A40: 30
1027N...	A40: 30
1027T...	A40: 30
1027U...	A40: 30, A40: 38
10284...	A40: 35
10285...	A40: 35
1028A...	A40: 34
1028N...	A40: 34
1028T...	A40: 34
1028U...	A40: 34, A40: 38
10294...	A40: 36
10414...	A40: 7
10424...	A40: 11
10434...	A40: 15
10444...	A40: 19
10454...	A40: 23
10474...	A40: 31
10484...	A40: 35
11214...	A40: 7
11224...	A40: 11
11234...	A40: 15
11244...	A40: 19
11254...	A40: 23
11264...	A40: 27
131...	A30: 48, A30: 49
132...	A30: 63, A30: 64
135...	A30: 95
136...	A30: 97
137...	A30: 103
138...	A30: 105
150...	A30: 34, A30: 35, A91: 22, A92: 19, A92: 21, A92: 23, A92: 25, A92: 27
151...	A30: 46, A30: 47, A30: 48, A91: 26,

Part No.	Page
	A92: 19, A92: 21, A92: 23, A92: 25, A92: 27
152...	A30: 61, A30: 62, A30: 63, A91: 30, A92: 19, A92: 21, A92: 23, A92: 25, A92: 27
153...	A30: 77, A30: 78, A30: 79, A91: 34
154...	A30: 88, A30: 89
155...	A30: 95
156...	A30: 97
157...	A30: 103
158...	A30: 105
15Y...	A30: 14, A30: 15, A92: 19, A92: 21, A92: 23, A92: 25, A92: 27
15Z...	A30: 24, A30: 25, A92: 19, A92: 21, A92: 23, A92: 25, A92: 27
180...	A30: 33
181...	A30: 45
182...	A30: 59
18Y...	A30: 13
18Z...	A30: 23
1C20...	A30: 36
1C21...	A30: 50
1C22...	A30: 65, A30: 66
1C23...	A30: 80
1C2Y...	A30: 16
1C2Z...	A30: 26
1C30...	A30: 37
1C31...	A30: 51
1C32...	A30: 67
1C3Y...	A30: 17
1C3Z...	A30: 27
1C50...	A30: 37
1C51...	A30: 51
1C52...	A30: 67
1C53...	A30: 81, A92: 7, A92: 9, A92: 11, A92: 13, A92: 15
1CSY...	A30: 17
1CSZ...	A30: 27
1N20...	A30: 37
1N21...	A30: 51
1N22...	A30: 67
1N2Y...	A30: 17
1N2Z...	A30: 27
<b>2</b>	
20231...	A40: 16
20241...	A40: 20
20251...	A40: 24
20261...	A40: 28
20411...	A40: 8
20421...	A40: 12
20431...	A40: 16
20441...	A40: 20
20451...	A40: 24
20461...	A40: 28

Part No.	Page
20611...	A40: 8
20621...	A40: 12
20631...	A40: 16
20641...	A40: 20
20651...	A40: 24
20661...	A40: 28
20671...	A40: 32
20681...	A40: 37
20811...	A40: 8
20821...	A40: 12
20831...	A40: 16
20841...	A40: 20
20851...	A40: 24
20861...	A40: 28
20871...	A40: 32
20881...	A40: 37
21000...	A30: 38, A30: 42
21005...	A30: 38
21010...	A30: 52
21011...	A40: 8
21015...	A30: 52
21020...	A30: 68
21021...	A40: 12
21025...	A30: 68
21030...	A30: 82
21031...	A40: 16
21041...	A40: 20
21051...	A40: 24
21061...	A40: 28
210Y0...	A30: 18, A30: 21
210Z0...	A30: 28, A30: 31
21411...	A40: 9
21421...	A40: 12
21431...	A40: 16
21441...	A40: 20
21451...	A40: 24
21461...	A40: 28
21471...	A40: 32
21481...	A40: 37
21511...	A40: 9
21521...	A40: 12
21531...	A40: 16
21541...	A40: 20
21551...	A40: 24
21561...	A40: 28
21571...	A40: 32
21611...	A40: 9
21621...	A40: 12
21631...	A40: 16
21641...	A40: 20
21651...	A40: 24
21661...	A40: 28
21671...	A40: 32
21681...	A40: 37
21811...	A40: 9
21821...	A40: 12
21831...	A40: 16
21841...	A40: 20
21851...	A40: 24
21861...	A40: 28
21871...	A40: 32
21881...	A40: 37
22000...	A30: 38, A30: 40,

Part No.	Page
	A30: 42, A91: 24
22005...	A30: 38, A30: 40, A30: 42, A91: 24
22010...	A30: 52, A30: 54, A30: 56, A91: 28
22011...	A40: 9
22015...	A30: 52, A30: 54, A30: 56, A91: 28
22020...	A30: 68, A30: 70, A30: 72, A91: 32
22021...	A40: 12
22025...	A30: 68, A30: 70, A30: 72, A91: 32
22030...	A30: 82, A30: 84, A30: 85, A91: 36
22031...	A40: 16
22040...	A30: 90, A30: 91, A30: 92
22041...	A40: 20
22050...	A30: 98, A30: 99, A30: 100
22051...	A40: 24
22061...	A40: 28
22070...	A30: 106, A30: 107, A30: 108
22071...	A40: 32
22081...	A40: 37
220Y0...	A30: 18, A30: 20, A30: 21
220Z0...	A30: 28, A30: 30, A30: 31
22211...	A40: 9
22221...	A40: 12
22231...	A40: 16
22241...	A40: 20
22261...	A40: 28
22271...	A40: 32
22281...	A40: 37
22421...	A40: 13
22431...	A40: 17
22461...	A40: 29
22471...	A40: 33
22621...	A40: 13
22631...	A40: 17
22641...	A40: 21
22651...	A40: 25
22661...	A40: 29
22671...	A40: 33
22821...	A40: 13
22831...	A40: 17
22841...	A40: 21
22851...	A40: 25
22861...	A40: 29
22881...	A40: 33
23010...	A30: 52, A30: 53, A30: 54, A30: 55, A30: 56
23015...	A30: 52, A30: 53, A30: 54, A30: 55, A30: 56
23020...	A30: 68, A30: 69, A30: 70, A30: 71, A30: 72

Part No.	Page
23025...	A30: 68, A30: 69, A30: 70, A30: 71, A30: 72
23030...	A30: 82, A30: 83, A30: 84, A30: 85
24000...	A30: 38, A30: 39, A30: 40, A30: 41, A30: 42, A91: 25
24005...	A30: 38, A30: 39, A30: 40, A30: 41, A30: 42, A91: 25
24010...	A30: 52, A30: 53, A30: 54, A30: 55, A30: 56, A91: 29
24015...	A30: 52, A30: 53, A30: 54, A30: 55, A30: 56, A91: 29
24020...	A30: 68, A30: 69, A30: 70, A30: 71, A30: 72, A91: 33
24025...	A30: 68, A30: 69, A30: 70, A30: 71, A30: 72, A91: 33
24030...	A30: 82, A30: 83, A30: 84, A30: 85, A91: 36
24040...	A30: 90, A30: 91, A30: 92
24050...	A30: 98, A30: 99, A30: 100
24070...	A30: 106, A30: 107, A30: 108
240Y0...	A30: 18, A30: 19, A30: 20, A30: 21
240Z0...	A30: 28, A30: 29, A30: 30, A30: 31
2430...	C: 26
2431...	C: 27
2440...	C: 22
2441...	C: 23
24410...	A40: 41
24420...	A40: 41
24430...	A40: 41
24440...	A40: 41
24450...	A40: 41
24460...	A40: 41
24470...	A40: 41
24480...	A40: 41
24500...	A30: 39
24510...	A30: 53
24520...	A30: 69
245Y0...	A30: 19
245Z0...	A30: 29
25000...	A30: 38, A30: 39, A30: 40, A30: 41, A30: 42, A91: 25
25005...	A30: 38, A30: 39, A30: 40, A30: 41, A30: 42, A91: 25
25010...	A30: 52, A30: 53, A30: 54, A30: 55, A30: 56, A91: 29
25015...	A30: 52, A30: 53,

Part No.	Page
	A30: 54, A30: 55, A30: 56, A91: 29
25020...	A30: 68, A30: 69, A30: 70, A30: 71, A30: 72, A91: 33
25025...	A30: 68, A30: 69, A30: 70, A30: 71, A30: 72
25030...	A30: 82, A30: 84, A30: 85
25040...	A30: 90, A30: 91, A30: 92
25050...	A30: 98, A30: 99, A30: 100
25070...	A30: 106, A30: 107, A30: 108
250Y0...	A30: 18, A30: 19, A30: 20, A30: 21
250Z0...	A30: 28, A30: 29, A30: 30, A30: 31
26000...	A30: 39, A30: 41, A30: 42
26005...	A30: 39, A30: 41, A30: 42
26010...	A30: 53, A91: 29
26015...	A91: 29
26020...	A30: 69, A91: 33
26020...	A30: 29
26500...	A30: 39
27000...	A30: 38, A30: 42
27010...	A30: 52, A30: 56
27020...	A30: 68, A30: 72
27030...	A30: 82, A30: 84, A30: 85
27040...	A30: 90, A30: 91, A30: 92
27050...	A30: 99, A30: 100
27070...	A30: 107, A30: 108
270Y0...	A30: 18, A30: 21
270Z0...	A30: 28, A30: 31
29000...	A30: 38, A30: 42
29010...	A30: 52, A30: 56
29020...	A30: 68, A30: 72
29030...	A30: 82, A30: 84, A30: 85
29040...	A30: 90, A30: 91, A30: 92
29050...	A30: 99, A30: 100
29070...	A30: 107, A30: 108
290Y0...	A30: 18, A30: 21
290Z0...	A30: 28, A30: 31
2T-2SR...	A30: 21, A30: 31, A30: 43, A30: 110
2T-3SR...	A30: 57, A30: 73, A30: 110
2T-4SR...	A30: 73, A30: 85, A30: 93, A30: 110, A40: 9, A40: 13, A40: 17, A40: 21, A40: 40
2T-5SR...	A30: 85, A30: 93, A30: 110, A40: 13, A40: 17, A40: 21,

Part No.	Page
	A40: 40
2T-6SR...	A30: 101, A30: 109, A30: 110, A40: 25, A40: 29, A40: 33, A40: 37, A40: 40
2T-55SR...	A40: 21, A40: 25, A40: 37, A40: 40
2T-60SR...	A40: 29, A40: 40
2T-65SR...	A40: 33, A40: 40
<b>3</b>	
30.50R...	C: 60
30.63R...	C: 60
30.80R...	C: 60
335...	A10: 4, A10: 5
35.50R...	C: 61
35.63R...	C: 61
360...	A10: 6, A10: 7, A10: 8, A10: 9
3610...	C: 28
3617...	C: 29
3620...	C: 24
3627...	C: 25
390...	A10: 10, A10: 11
<b>4</b>	
40.50R...	C: 61
40.63R...	C: 61
4300...	C: 50, C: 51
4305...	C: 52, C: 53
4330...	C: 42, C: 43
4335...	C: 44, C: 45
434...	A30: 87
435...	A30: 94
4350...	C: 46, C: 47
4355...	C: 48, C: 49
436...	A30: 96
437...	A30: 102
438...	A30: 104
450...	A30: 32, A91: 23, A92: 7, A92: 9, A92: 11, A92: 13, A92: 15, A92: 17, A92: 18, A92: 20, A92: 22, A92: 24, A92: 26, A92: 28
4500...	C: 38, C: 39
4505...	C: 40, C: 41
451...	A30: 44, A91: 27, A92: 7, A92: 9, A92: 11, A92: 13, A92: 15, A92: 17, A92: 18, A92: 20, A92: 22, A92: 24, A92: 26, A92: 28
452...	A30: 58, A91: 31, A92: 7, A92: 9, A92: 11, A92: 13, A92: 15, A92: 17, A92: 18, A92: 20, A92: 22, A92: 24, A92: 26, A92: 28
453...	A30: 75, A91: 35, A92: 7, A92: 9,

Part No.	Page
	A92: 11, A92: 15, A92: 17, A92: 18, A92: 19, A92: 20, A92: 21, A92: 23, A92: 25, A92: 26, A92: 27, A92: 28
454...	A30: 86, A92: 7, A92: 9, A92: 11, A92: 13, A92: 15, A92: 17, A92: 18, A92: 19, A92: 20, A92: 21, A92: 22, A92: 23, A92: 24, A92: 25, A92: 26, A92: 27, A92: 28
455...	A30: 94
4550...	C: 34, C: 35
4555...	C: 36, C: 37
456...	A30: 96
457...	A30: 102
458...	A30: 104
45Y...	A30: 12, A92: 7, A92: 9, A92: 11, A92: 13, A92: 15, A92: 17, A92: 18, A92: 20, A92: 22, A92: 24, A92: 26, A92: 28
45Z...	A30: 22, A92: 7, A92: 9, A92: 11, A92: 13, A92: 15, A92: 17, A92: 18, A92: 20, A92: 22, A92: 24, A92: 26, A92: 28
483...	A30: 74, A30: 76
4C10...	A30: 32, A91: 23, A92: 7, A92: 9, A92: 11, A92: 13, A92: 15
4C11...	A30: 44, A91: 27, A92: 7, A92: 9, A92: 11, A92: 13, A92: 15
4C12...	A30: 58, A91: 31, A92: 7, A92: 9, A92: 11, A92: 13, A92: 15
4C1Y...	A30: 12, A92: 7, A92: 9, A92: 11, A92: 13, A92: 15
4C1Z...	A30: 22, A92: 7, A92: 9, A92: 11, A92: 15
4C20...	A30: 32, A92: 17
4C21...	A30: 44, A92: 17
4C22...	A30: 58, A92: 17
4C2Y...	A30: 12, A92: 17
4C2Z...	A30: 22, A92: 17
<b>6</b>	
60111C45...	A20: 15
60111H...	A20: 15
60112C45...	A20: 19

Part No.	Page
60112H...	A20: 19
60113C45...	A20: 23
60113H...	A20: 23
60114C45...	A20: 27
60114H...	A20: 27
60115C45...	A20: 31
60115H...	A20: 31
60116C45...	A20: 35
60116H...	A20: 35
60117C45...	A20: 39
60117H...	A20: 39
60118C45...	A20: 43
60118H...	A20: 43
60120C45...	A20: 47
60120H...	A20: 47
60122C45...	A20: 51
60122H...	A20: 51
60124C45...	A20: 55
60124H...	A20: 55
60126C45...	A20: 59
60126H...	A20: 59
60129C45...	A20: 63
60129H...	A20: 63
60132C45...	A20: 67
60132H...	A20: 67
60311H...	A20: 15
60311S...	A20: 15
60312H...	A20: 19
60312S...	A20: 19
60313H...	A20: 23
60313S...	A20: 23
60314H...	A20: 27
60314S...	A20: 27
60315H...	A20: 31
60315S...	A20: 31
60316H...	A20: 35
60316S...	A20: 35
60317H...	A20: 39
60317S...	A20: 39
60318H...	A20: 43
60318S...	A20: 43
60320H...	A20: 47
60320S...	A20: 47
60322H...	A20: 51
60322S...	A20: 51
60324H...	A20: 55
60324S...	A20: 55
60326H...	A20: 59
60326S...	A20: 59
60329H...	A20: 63
60329S...	A20: 63
60332H...	A20: 67
60332S...	A20: 67
60511H...	A20: 15
60511S...	A20: 15
60512H...	A20: 19
60512S...	A20: 19
60513H...	A20: 23
60513S...	A20: 23
60514H...	A20: 27
60514S...	A20: 27
60515H...	A20: 31
60515S...	A20: 31

Part No.	Page
60516H...	A20: 35
60516S...	A20: 35
60517H...	A20: 39
60517S...	A20: 39
60518H...	A20: 43
60518S...	A20: 43
60520H...	A20: 47
60520S...	A20: 47
60522H...	A20: 51
60522S...	A20: 51
60524H...	A20: 55
60524S...	A20: 55
60526H...	A20: 59
60526S...	A20: 59
60529H...	A20: 63
60529S...	A20: 63
60532H...	A20: 67
60532S...	A20: 67
60711H...	A20: 15
60711S...	A20: 15
60712H...	A20: 19
60712S...	A20: 19
60713H...	A20: 23
60713S...	A20: 23
60714H...	A20: 27
60714S...	A20: 27
60715H...	A20: 31
60715S...	A20: 31
60716H...	A20: 35
60716S...	A20: 35
60717H...	A20: 39
60717S...	A20: 39
60718H...	A20: 43
60718S...	A20: 43
60720H...	A20: 47
60720S...	A20: 47
60722H...	A20: 51
60722S...	A20: 51
60724H...	A20: 55
60724S...	A20: 55
60726H...	A20: 59
60726S...	A20: 59
60729H...	A20: 63
60729S...	A20: 63
60732H...	A20: 67
60732S...	A20: 67
<b>7</b>	
7000...	C: 12
7000-MC...	C: 16
7000-ML...	C: 17, C: 19
7000-MM...	C: 18
7000-VI...	C: 14, C: 15
7001-MC...	C: 16
7001-ML...	C: 17
7001-MM...	C: 18
7001-VI...	C: 14, C: 15
7400...	C: 12
7405...	C: 13
7705...	C: 13
7C111P...	A20: 14
7C112P...	A20: 18
7C113P...	A20: 22
7C114P...	A20: 26

Part No.	Page
7C115P...	A20: 30
7C116P...	A20: 34
7C117P...	A20: 38
7C118P...	A20: 42
7C120P...	A20: 46
7C122P...	A20: 50
7C124P...	A20: 54
7C126P...	A20: 58
7C129P...	A20: 62
7C132P...	A20: 66
7C211P...	A20: 14
7C212P...	A20: 18
7C213P...	A20: 22
7C214P...	A20: 26
7C215P...	A20: 30
7C217P...	A20: 38
7C218P...	A20: 42
7C220P...	A20: 46
7C222P...	A20: 50
7C224P...	A20: 54
7C229P...	A20: 62
7C232P...	A20: 66
<b>9</b>	
94500...	C: 38, C: 39
94505...	C: 40, C: 41
94550...	C: 34, C: 35
94555...	C: 36, C: 37
<b>A</b>	
AS5202...	A92: 14, A92: 15, A92: 26, A92: 27
ATKK...	A92: 18, A92: 20, A92: 22, A92: 24, A92: 26, A92: 28
ATKU...	A92: 19, A92: 21, A92: 23, A92: 25, A92: 27
<b>B</b>	
BTA0...	A93: 4
BTA1...	A93: 5
BTA2...	A93: 6
BTA3...	A93: 7
BTAT...	A93: 4, A93: 5, A93: 6, A93: 7
BTB.40...	C: 57
BTB.50...	C: 57
BTH...	B20: 4, B20: 5, B20: 10, B20: 28, B20: 31, B20: 35, B20: 36, B20: 39, B20: 40, B20: 43, B20: 44
<b>C</b>	
C34...	A60: 7, A60: 9, A60: 11, A60: 13, A60: 15, A60: 17, A60: 19, A60: 21, A60: 23, A60: 25, A60: 27

Part No.	Page
CCGT...	X: 22
CCMT...	X: 22
CIL.25...	C: 59
CIL.32...	C: 59
CIL.40...	C: 59
CB...	B20: 17, B20: 22, B20: 30, B20: 34, B20: 38, B20: 42
CB038M...	B20: 53, B20: 54
CB050M...	B20: 53, B20: 54
CB076M...	B20: 53, B20: 54
CB1000...	B20: 49
CB1250...	B20: 49
CB1500...	B20: 48, B20: 49, B20: 50, B20: 51
CB2000...	B20: 48, B20: 49, B20: 50, B20: 51
CB2500...	B20: 50
CB2500BMA...	B20: 27
CB3000...	B20: 48, B20: 49, B20: 50, B20: 51
CB6000...	B20: 50
CBS1250B...	B20: 9
CCMT...	B20: 14, B20: 18, B20: 25, B20: 29, B20: 33, B20: 37, B20: 41, B20: 45
CCMT060202...	B20: 6, B20: 11
<b>D</b>	
DCGT...	X: 22
DCMT...	X: 22
<b>G</b>	
G1731...	A92: 16, A92: 17, A92: 28
<b>H</b>	
HSKA.100...	C: 58
HSKA.63...	C: 58
HXT0311S...	A20: 13
HXT0312S...	A20: 17
HXT0313S...	A20: 21
HXT0314S...	A20: 25
HXT0315S...	A20: 29
HXT0316S...	A20: 33
HXT0317S...	A20: 37
HXT0318S...	A20: 41
HXT0320S...	A20: 45

Part No.	Page
HXT0322S...	A20: 49
HXT0324S...	A20: 53
HXT0326S...	A20: 57
HXT0329S...	A20: 61
HXT0332S...	A20: 65
HXT0511S...	A20: 13
HXT0512S...	A20: 17
HXT0513S...	A20: 21
HXT0514S...	A20: 25
HXT0515S...	A20: 29
HXT0516S...	A20: 33
HXT0517S...	A20: 37
HXT0518S...	A20: 41
HXT0520S...	A20: 45
HXT0522S...	A20: 49
HXT0524S...	A20: 53
HXT0526S...	A20: 57
HXT0529S...	A20: 61
HXT0532S...	A20: 65
HXT0711S...	A20: 13
HXT0712S...	A20: 17
HXT0713S...	A20: 21
HXT0714S...	A20: 25
HXT0715S...	A20: 29
HXT0716S...	A20: 33
HXT0717S...	A20: 37
HXT0718S...	A20: 41
HXT0720S...	A20: 45
HXT0722S...	A20: 49
HXT0724S...	A20: 53
HXT0726S...	A20: 57
HXT0729S...	A20: 61
HXT0732S...	A20: 65
HXT1011S...	A20: 13
HXT1012S...	A20: 17
HXT1013S...	A20: 21
HXT1014S...	A20: 25
HXT1015S...	A20: 29
HXT1016S...	A20: 33
HXT1017S...	A20: 37
HXT1018S...	A20: 41
HXT1020S...	A20: 45
HXT1022S...	A20: 49
HXT1024S...	A20: 53
HXT1026S...	A20: 57
HXT1029S...	A20: 61
HXT1032S...	A20: 65
<b>I</b>	
I6149...	A92: 12, A92: 13, A92: 22, A92: 23, A92: 24, A92: 25
<b>J</b>	
J1926...	A92: 6, A92: 7, A92: 8, A92: 9, A92: 18, A92: 19, A92: 20, A92: 21
<b>L</b>	
LCB...	B20: 22, B20: 23, B20: 24
<b>M</b>	
MBS0500B...	B20: 3
MD...	B20: 13
MT2...	B20: 52

Part No.	Page
MT3...	B20: 52
MT4...	B20: 52
MT5...	B20: 52
<b>N</b>	
NMTB30...	B20: 53
NMTB40...	B20: 53
NMTB50...	B20: 53
<b>O</b>	
OP-05T308...	A50: 6, A60: 7, A70: 8, A70: 9, A60: 9, A60: 11, A60: 13, A60: 15, A60: 19, A60: 21, A60: 23, A60: 27, A70: 6, A70: 7, A70: 10, A70: 11, A70: 12, A70: 13, A70: 14, A70: 15, A60: 17, A60: 25
OP-060408...	A50: 8, A50: 10, A50: 18
OP-080508...	A50: 10, A50: 12, A50: 20, A50: 22
OP-090608...	A50: 12, A50: 14, A50: 16, A50: 24, A50: 26
OP1...	A70: 6, A70: 8, A70: 9, A70: 10, A70: 11, A70: 12, A70: 13, A70: 14, A70: 15
OP2...	A70: 6, A70: 8, A70: 9, A70: 10, A70: 11, A70: 12, A70: 13, A70: 14, A70: 15
OP3...	A70: 6, A70: 8, A70: 9, A70: 10, A70: 11, A70: 12, A70: 13, A70: 14, A70: 15
OP4...	A70: 6, A70: 8, A70: 9, A70: 10, A70: 11, A70: 12, A70: 13, A70: 14, A70: 15
<b>R</b>	
R34X22...	A60: 6, A60: 7
R34X35...	A60: 6, A60: 7
R34X45...	A60: 6, A60: 7
R36X22...	A60: 8, A60: 9
R36X35...	A60: 8, A60: 9
R36X45...	A60: 8, A60: 9
R38X22...	A60: 10, A60: 11
R38X35...	A60: 10, A60: 11
R38X45...	A60: 10, A60: 11
R42X22...	A60: 12, A60: 13
R42X35...	A60: 12, A60: 13
R42X45...	A60: 12, A60: 13
R44X22...	A60: 14
R44X35...	A60: 14
R46X22...	A60: 16
R46X35...	A60: 16

Part No.	Page
R48X10...	A60: 18
R48X25...	A60: 18
R52X10...	A60: 20
R52X25...	A60: 20
R54X10...	A60: 22
R54X25...	A60: 22
R56X10...	A60: 24
R56X25...	A60: 24
R58X10...	A60: 26
R58X25...	A60: 26
RDKF...	D: 18
RDKH...	D: 7, D: 8, D: 9
RDKI...	D: 12
RDKK...	D: 14
RDKL...	D: 16
RDKM...	D: 20
RDKN...	D: 22
RDKO...	D: 24
RDKP...	D: 26
RDKQ...	D: 28
RDKR...	D: 30
RDKS...	D: 32
RDKT...	D: 34
RDKU...	D: 36
RDRY...	D: 38
RSKF...	D: 19
RSKH...	D: 10, D: 11
RSKI...	D: 13
RSKK...	D: 15
RSKL...	D: 17
RSKM...	D: 21
RSKN...	D: 23
RSKO...	D: 25
RSKP...	D: 27
RSKQ...	D: 29
RSKR...	D: 31
RSKS...	D: 33
RSKT...	D: 35
RSKU...	D: 37
RSRY...	D: 39
R8...	B20: 52
<b>S</b>	
SCMT...	X: 23
SP34X22...	A60: 6, A60: 7
SP36X22...	A60: 8, A60: 9
SP38X22...	A60: 10, A60: 11
SP42X22...	A60: 12, A60: 13
SP44X22...	A60: 14
SP46X22...	A60: 16
SP48X10...	A60: 18
SP48X25...	A60: 18
SP52X10...	A60: 20
SP52X25...	A60: 20
SP54X10...	A60: 22
SP54X25...	A60: 22
SP56X10...	A60: 24
SP56X25...	A60: 24
SP58X10...	A60: 26
SP58X25...	A60: 26
ST03120...	A91: 6
ST03140...	A91: 7, A91: 8
ST03150...	A91: 9
ST03160...	A91: 10
<b>T</b>	
T-ACR-45...	A30: 43, A30: 57, A30: 73, A30: 111
TCGT...	X: 23
TCMT...	A20: 15, A20: 19, A20: 23, A20: 27, A20: 31, A20: 35, A20: 39, A20: 43, A20: 47, A20: 51, A20: 55, A20: 59, A20: 63, A20: 67, X: 23
THN...	E: 41
THP...	E: 48
THT...	E: 41
TM...	E: 18, E: 19, E: 20, E: 21, E: 22, E: 23, E: 24, E: 25, E: 26, E: 27, E: 28, E: 29, E: 30, E: 31, E: 33
TMAU...	A92: 21

Part No.	Page
ST03170...	A91: 11
ST03180...	A91: 12
ST03200...	A91: 13
ST03220...	A91: 14
ST03225...	A91: 14
ST03240...	A91: 15
ST03260...	A91: 16
ST03290...	A91: 17
ST03320...	A91: 18
ST05120...	A91: 6
ST05140...	A91: 7, A91: 8
ST05150...	A91: 9
ST05160...	A91: 10
ST05170...	A91: 11
ST05180...	A91: 12
ST05200...	A91: 13
ST05220...	A91: 14
ST05225...	A91: 14
ST05240...	A91: 15
ST05260...	A91: 16
ST05290...	A91: 17
ST05320...	A91: 18
ST07120...	A91: 6
ST07140...	A91: 7, A91: 8
ST07150...	A91: 9
ST07160...	A91: 10
ST07170...	A91: 11
ST07180...	A91: 12
ST07200...	A91: 13
ST07220...	A91: 14
ST07225...	A91: 14
ST07240...	A91: 15
ST07260...	A91: 16
ST07290...	A91: 17
ST07320...	A91: 18
SS0500...	B20: 51
SS0625...	B20: 51
SS0750...	B20: 51
SS1000...	B20: 51
SS1250...	B20: 51
SS1500...	B20: 51
SS2000...	B20: 51
<b>T</b>	
T-ACR-45...	A30: 43, A30: 57, A30: 73, A30: 111
TCGT...	X: 23
TCMT...	A20: 15, A20: 19, A20: 23, A20: 27, A20: 31, A20: 35, A20: 39, A20: 43, A20: 47, A20: 51, A20: 55, A20: 59, A20: 63, A20: 67, X: 23
THN...	E: 41
THP...	E: 48
THT...	E: 41
TM...	E: 18, E: 19, E: 20, E: 21, E: 22, E: 23, E: 24, E: 25, E: 26, E: 27, E: 28, E: 29, E: 30, E: 31, E: 33
TMAU...	A92: 21

Part No.	Page
TMBK...	E: 8
TMBKxBSPP...	E: 11
TMBKxBSPT...	E: 10
TMxBSPP...	E: 11
TMxBSPT...	E: 10
TMxBSW...	E: 8, E: 9
TMMK...	E: 26, E: 28
TMNKxNPT...	E: 12
TMNKxNPTF...	E: 14
TMxNPS...	E: 16
TMxNPSF...	E: 17
TMxNPT...	E: 12, E: 13
TMxNPTF...	E: 14, E: 15
TMUK...	E: 18, E: 19, E: 20, E: 21
TN100K-FA...	E: 43
TN100K-UN...	E: 44, E: 45
TN100K-UNJ...	E: 46
TN150K-AP...	E: 43
TN150K-BSPP...	E: 43
TN150K-BSPT...	E: 42
TN150K-FA...	E: 43
TN150K-M...	E: 47
TN150K-NPT...	E: 42
TN150K-NPTF...	E: 42
TN150K-UN...	E: 44, E: 45
TN150K-UNJ...	E: 46
TNR...	E: 48
TP075K-BSPP...	E: 37
TP075K-BSPT...	E: 37
TP075K-M...	E: 40
TP075K-NPT...	E: 36
TP075K-NPTF...	E: 36
TP075K-UN...	E: 38
TP075K-UNJ...	E: 39
TP100K-BSPP...	E: 37
TP100K-BSPT...	E: 37
TP100K-M...	E: 40
TP100K-NPT...	E: 36
TP100K-NPTF...	E: 36
TP100K-UN...	E: 38
TP100K-UNJ...	E: 39
TSN...	E: 49
TSR...	E: 49
TCGT...	B20: 18, B20: 25
<b>V</b>	
V3300D...	A50: 6
V3301D...	A50: 6
V3316D...	A50: 6
V3318D...	A50: 6
V3320D...	A50: 6
V3800D...	A50: 8
V3801D...	A50: 8

Part No.	Page
V3815D...	A50: 8
V3817D...	A50: 8
V3818D...	A50: 8
V3820D...	A50: 8
V4401D...	A50: 10
V4417D...	A50: 10
V4418D...	A50: 10
V4422D...	A50: 10
V5101D...	A50: 12
V5118D...	A50: 12
V5120D...	A50: 12
V5122D...	A50: 12
V5701D...	A50: 14
V5702D...	A50: 14
V5722D...	A50: 14
V5724D...	A50: 14
V5726D...	A50: 14
V6302D...	A50: 16
V6326D...	A50: 16
V6329D...	A50: 16
V6332D...	A50: 16
V7002S...	A50: 18
V7029S...	A50: 18
V7602S...	A50: 20
V7629S...	A50: 20
V8302S...	A50: 22
V8332S...	A50: 22
V8902S...	A50: 24
V8929S...	A50: 24
V9502S...	A50: 26
V9532S...	A50: 26
<b>W</b>	
W3303H...	A50: 7
W3803H...	A50: 7
W3805H...	A50: 7
W3808H...	A50: 7
W3810H...	A50: 7
W4403H...	A50: 9, A50: 11
W4405H...	A50: 9, A50: 11
W4408H...	A50: 9, A50: 11
W4410H...	A50: 9, A50: 11
W5103H...	A50: 13
W5105H...	A50: 13
W5108H...	A50: 13
W5110H...	A50: 13
W5703H...	A50: 15
W5705H...	A50: 15
W5708H...	A50: 15
W5710H...	A50: 15
W6303H...	A50: 17
W6305H...	A50: 17
W6308H...	A50: 17
W6310H...	A50: 17
W7003H...	A50: 19
W7005H...	A50: 19
W7008H...	A50: 19
W7010H...	A50: 19
W7603H...	A50: 21
W7605H...	A50: 21
W7608H...	A50: 21
W8303H...	A50: 23
W8305H...	A50: 23
W8308H...	A50: 23

Part No.	Page
W8903H...	A50: 25
W8905H...	A50: 25
W8908H...	A50: 25
W9503H...	A50: 27
W9505H...	A50: 27
W9508H...	A50: 27
WP...	A50: 18, A50: 20, A50: 22, A50: 24, A50: 26
WBGX030101...	B20: 6, B20: 11, B20: 29, B20: 33, B20: 37
<b>X</b>	
X1926...	A92: 10, A92: 11
XTK11...	A20: 12
XTK12...	A20: 16
XTK13...	A20: 20
XTK14...	A20: 24
XTK15...	A20: 28
XTK16...	A20: 32
XTK17...	A20: 36
XTK18...	A20: 40
XTK20...	A20: 44
XTK22...	A20: 48
XTK24...	A20: 52
XTK26...	A20: 56
XTK29...	A20: 60
XTK32...	A20: 64
XTN11...	A20: 12
XTN12...	A20: 16
XTN13...	A20: 20
XTN14...	A20: 24
XTN15...	A20: 28
XTN16...	A20: 32
XTN17...	A20: 36
XTN18...	A20: 40
XTN20...	A20: 44
XTN22...	A20: 48
XTN24...	A20: 52
XTN26...	A20: 56
XTN29...	A20: 60
XTN32...	A20: 64
XTP11...	A20: 12
XTP12...	A20: 16
XTP13...	A20: 20
XTP14...	A20: 24
XTP15...	A20: 28
XTP16...	A20: 32
XTP17...	A20: 36
XTP18...	A20: 40
XTP20...	A20: 44
XTP22...	A20: 48
XTP24...	A20: 52
XTP26...	A20: 56
XTP29...	A20: 60
XTP32...	A20: 64
XTST12...	A91: 6
XTST13...	A91: 7
XTST14...	A91: 8
XTST15...	A91: 9
XTST16...	A91: 10

<b>Part No.</b>	<b>Page</b>
XTST17...	A91: 11
XTST18...	A91: 12
XTST20...	A91: 13
XTST22...	A91: 14
XTST24...	A91: 15
XTST26...	A91: 16
XTST29...	A91: 17
XTST32...	A91: 18







# Guaranteed Test / Demo Application Form

Distributor PO # \_\_\_\_\_

The following must be filled out completely before your test will be considered

**IMPORTANT:** For processing, send Purchase Order to your Allied Field Sales Engineer (FSE). Please clearly mark the paperwork as "Test Order."

## Distributor Information

Company Name: \_\_\_\_\_  
 Contact: \_\_\_\_\_  
 Account Number: \_\_\_\_\_  
 Phone: \_\_\_\_\_  
 Email: \_\_\_\_\_

## End User Information

Company Name: \_\_\_\_\_  
 Contact: \_\_\_\_\_  
 Industry: \_\_\_\_\_  
 Phone: \_\_\_\_\_  
 Email: \_\_\_\_\_

**Current Process** List all tooling, coatings, substrates, speeds and feeds, tool life, and any problems you are experiencing

\_\_\_\_\_

\_\_\_\_\_

**Test Objective** List what would make this a successful test (i.e. penetration rate, finish, tool life, hole size, etc.)

\_\_\_\_\_

\_\_\_\_\_

## Application Information

Hole Diameter: _____ in/mm	Tolerance: _____	Material: _____ (4150 / A36 / Cast Iron / etc.)
Pre-existing Diameter: _____ in/mm	Depth of Cut: _____ in/mm	Hardness: _____ (BHN / Rc)
Required Finish: _____ RMS	State: _____	(Casting / Hot rolled / Forging)

## Machine Information

Machine Type: _____ (Lathe / Screw machine / Machine center / etc.)	Builder: _____ (Haas, Mori Seiki, etc.)	Model #: _____
Shank Required: _____ (CAT50 / Morse taper, etc.)	Power: _____ HP/KW	
Rigidity: _____	Orientation: _____	Tool Rotating: _____
<input type="checkbox"/> Excellent	<input type="checkbox"/> Vertical	<input type="checkbox"/> Yes
<input type="checkbox"/> Good	<input type="checkbox"/> Horizontal	<input type="checkbox"/> No
<input type="checkbox"/> Poor		Thrust: _____ lbs/N

## Coolant Information

Coolant Delivery: _____ (Through tool / Flood)	Coolant Pressure: _____ PSI / bar
Coolant Type: _____ (Air mist, oil, synthetic, water soluble, etc.)	Coolant Volume: _____ GPM / LPM

## Requested Tooling

QTY	Item Number	QTY	Item Number



**Allied Machine & Engineering**  
 120 Deeds Drive  
 Dover, OH 44622

Telephone: (330) 343-4283  
 Toll Free USA & Canada: (800) 321-5537  
 Fax: (330) 602-3400  
 Email: info@alliedmachine.com

## Warranty Information



Allied Machine & Engineering ("Allied Machine") warrants to original equipment manufacturers, distributors, industrial and commercial users of its products for one year from the original date of sale that each new product manufactured or supplied by Allied Machine shall be free from defects in material and workmanship.

Allied Machine's sole and exclusive obligation under this warranty is limited to, at its option, without additional charge, replacing or repairing this product or issuing a credit. For this warranty to be applied, the product must be returned freight prepaid to the plant designated by an Allied Machine representative and which, upon inspection, is determined by Allied Machine to be defective in material and workmanship.

Complete information as to operating conditions, machine, setup, and the application of cutting fluid should accompany any product returned for inspection. This warranty shall not apply to any Allied Machine products which have been subjected to misuse, abuse, improper operating conditions, improper machine setup or improper application of cutting fluid or which have been repaired or altered if such repair or alteration, in the judgement of Allied Machine, would adversely affect the performance of the product.

THIS WARRANTY IS IN LIEU OF ALL OTHER WARRANTIES, EXPRESS OR IMPLIED, INCLUDING ANY IMPLIED WARRANTY OF MERCHANTABILITY OR FITNESS FOR A PARTICULAR PURPOSE. Allied Machine shall have no liability or responsibility for any claim, whether in contract, tort or otherwise, for any loss or damage arising out of, connected with, or resulting from the manufacture, sale, delivery or use of any product sold hereunder, in excess of the cost of replacement or repair as provided herein.

Allied Machine shall not be liable in contract or in tort (including, without limitation, negligence, strict liability or otherwise) for economic losses of any kind or for any special, incidental, indirect, consequential, punitive or exemplary damages arising in any way out of the performance of, or failure to perform this agreement.

ALL PRICES, DELIVERIES, DESIGNS, AND MATERIALS ARE SUBJECT TO CHANGE WITHOUT NOTICE.



Allied Machine & Engineering  
Registered to ISO 9001  
10001329

## United States

### Allied Machine & Engineering

120 Deeds Drive  
Dover OH 44622  
United States

**Phone:**  
+1.330.343.4283

**Fax:**  
+1.330.602.3400

**Toll Free USA and Canada:**  
800.321.5537

**Toll Free USA and Canada:**  
800.223.5140

### Allied Machine & Engineering

485 W Third Street  
Dover OH 44622  
United States

**Phone:**  
+1.330.343.4283

**Fax:**  
+1.330.364.7666  
(Engineering Dept.)

**Toll Free USA and Canada:**  
800.321.5537

## Europe

### Allied Machine & Engineering Co. (Europe) Ltd.

93 Vantage Point  
Pensnett Estate  
Kingswinford  
West Midlands  
DY6 7FR England

**Phone:**  
+44 (0) 1384.400900

### Wohlhaupter GmbH

Maybachstrasse 4  
Postfach 1264  
72636 Frickenhausen  
Germany

**Phone:**  
+49 (0) 7022.408.0

**Fax:**  
+49 (0) 7022.408.212

## Asia

### Wohlhaupter India Pvt. Ltd.

B-23, 2nd Floor  
B Block Community Centre  
Janakpuri, New Delhi - 110058  
India

**Phone:**  
+91 (0) 11.41827044

Your local Allied Machine representative:



[www.alliedmachine.com](http://www.alliedmachine.com)

Allied Machine & Engineering is registered by DQS to ISO 9001 10001329

© 2018 Allied Machine & Engineering  
Literature Order Number: AMPC  
Print Date: June 2018